



ParaFlow Two Stage Absorption Units

RENEWAL PARTS

Supersedes: FORM 155.17-RP2 (1292)

993

FORM 155.17-RP1

FOR MODELS

**YPC-F-15GL
THRU
YPC-F-22G
(50 AND 60 HERTZ)
345 TONS THRU 1500 TONS**

**YPC-ST-16GL
THRU
YPC-ST-22G
(50 AND 60 HERTZ)
450 TONS THRU 1500 TONS**

UNIT NOMENCLATURE

YPC-FN-16GL-46-H-S

Model
York Paraflow Chiller

Heat source
FN—Direct fired (natural gas)
FD—Direct fired (natural gas/oil)
FO—Direct fired (no. 2 oil)
FX—Direct fired (other)
ST—Steam
HR—Heat recovery

Size
15GL to 22GL

Tube type
S—Standard tubes
A—Tube Enhancement A
B—Tube Enhancement B
C—Tube Enhancement C
X—Special tubes

Hot water heater
S—Standard heater
H—Hi temperature heater
C—Cooling only

Electrical
17—208-3-60
28—230-3-60
46—460-3-60

**CONTROL COMPONENTS—CONTROL PANEL
SEE FIGURES 1 THRU 4**

ITEM	DESCRIPTION	FIG. NO.	QTY.	PART NO.
1	RELAY (1R)	1	1	024-23962-000
2	TRANSFORMER (1T)	1	1	025-27911-000
3	FUSE (1FU), 7A	1	1	025-29905-000
4	CONTROL, I/O EXPANSION BOARD	1	1	031-01301-000
5	CONTROL, POWER SUPPLY	1	1	031-01080-000
6	CONTROL, DIGITAL INPUT	1	1	031-00935-000
7	FASTENER, PAWL ADJ.	3	1	021-17252-000
8	DISPLAY	2	1	031-00775-001
9	SWITCH, ROCKER	3	1	024-23143-000
10	SUPPRESSOR	1	1	031-00808-000
11	CONTROL MICRO BOARD (NOTE 2)	1	1	031-01065-001
12	KEYPAD	3	1	024-25570-000
13	EPROM, PROGRAMMED	4	1	TABLE 1
14	CONTROL, RELAY BOARD	1	1	031-01199-000
15	FUSE HOLDER	1	1	025-13991-000
16	CONTROL, REMOTE RESET (CUSTOMER OPTION)	1	NOTE 1	031-00814-000
17	CARD FILE (CUSTOMER OPTION)	1	1	031-00827-000
18	IC, REAL TIME CLOCK—U16	4	1	031-00955-000
19	CABLE, RIBBON—I/O EXPANSION BOARD, J9, J10	1	2	031-01322-000
20	CABLE, RIBBON—RELAY BOARD J3	1	1	031-01323-000
21	CABLE, RIBBON—KEYPAD	1	1	031-00950-000
22	CABLE, RIBBON—RELAY BOARD J1	1	1	031-00951-000
23	CABLE, RIBBON—DISPLAY	2	1	031-00952-000
24	CABLE, RIBBON—DIGITAL INPUT BD. J1	1	1	031-00953-000
25	CABLE, RIBBON—MICRO BD. J2	1	1	031-01321-000

NOTES:

1. If it is desired to remotely reset both the leaving water temp setpoint (gas/oil or steam) and the load limit setpoint (steam units only), 2 each remote reset boards are required. Otherwise, only 1 each is required.
2. Replacement Micro Boards are supplied without EPROM. Remove EPROM from defective board and use in replacement board. If new EPROM is required, refer to Table 1.

TABLE 1

VERSION	APPLICATION	PART NO.
A.01S.05	STANDARD	031-01332-001
A.01F.05	STANDARD WITH FAX-4500	031-01332-002

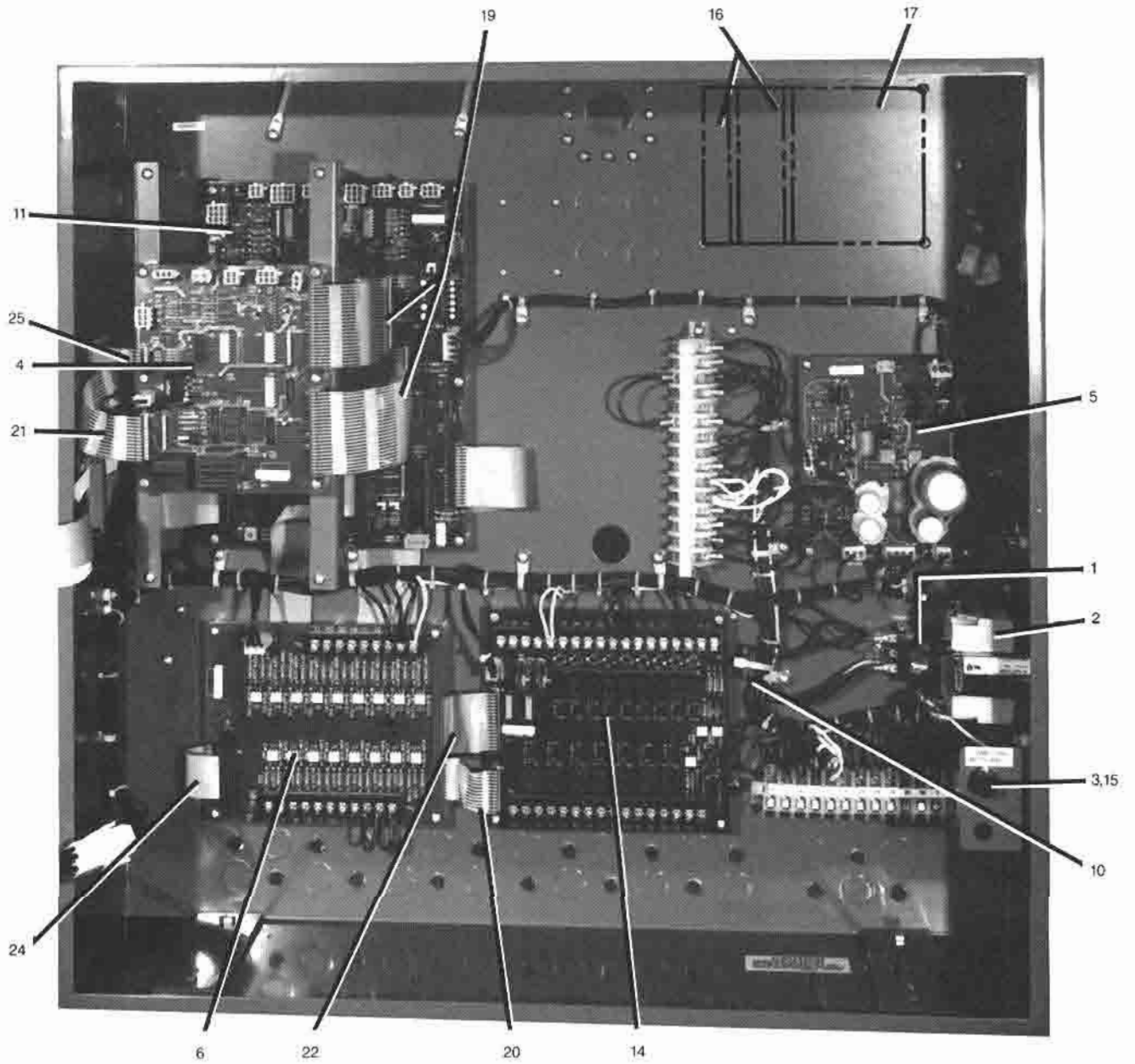

FIG. 1

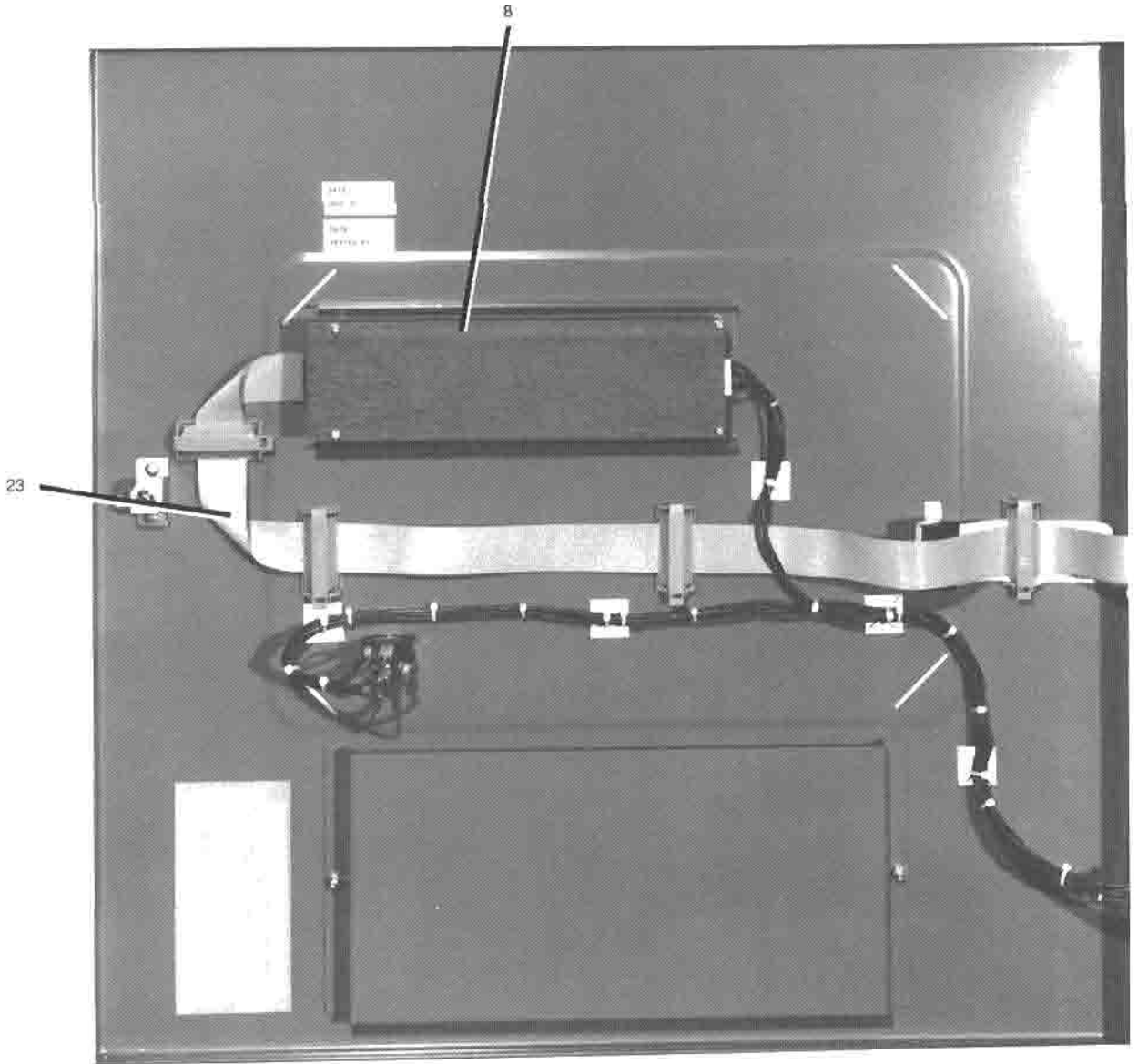

FIG.2



FIG.3

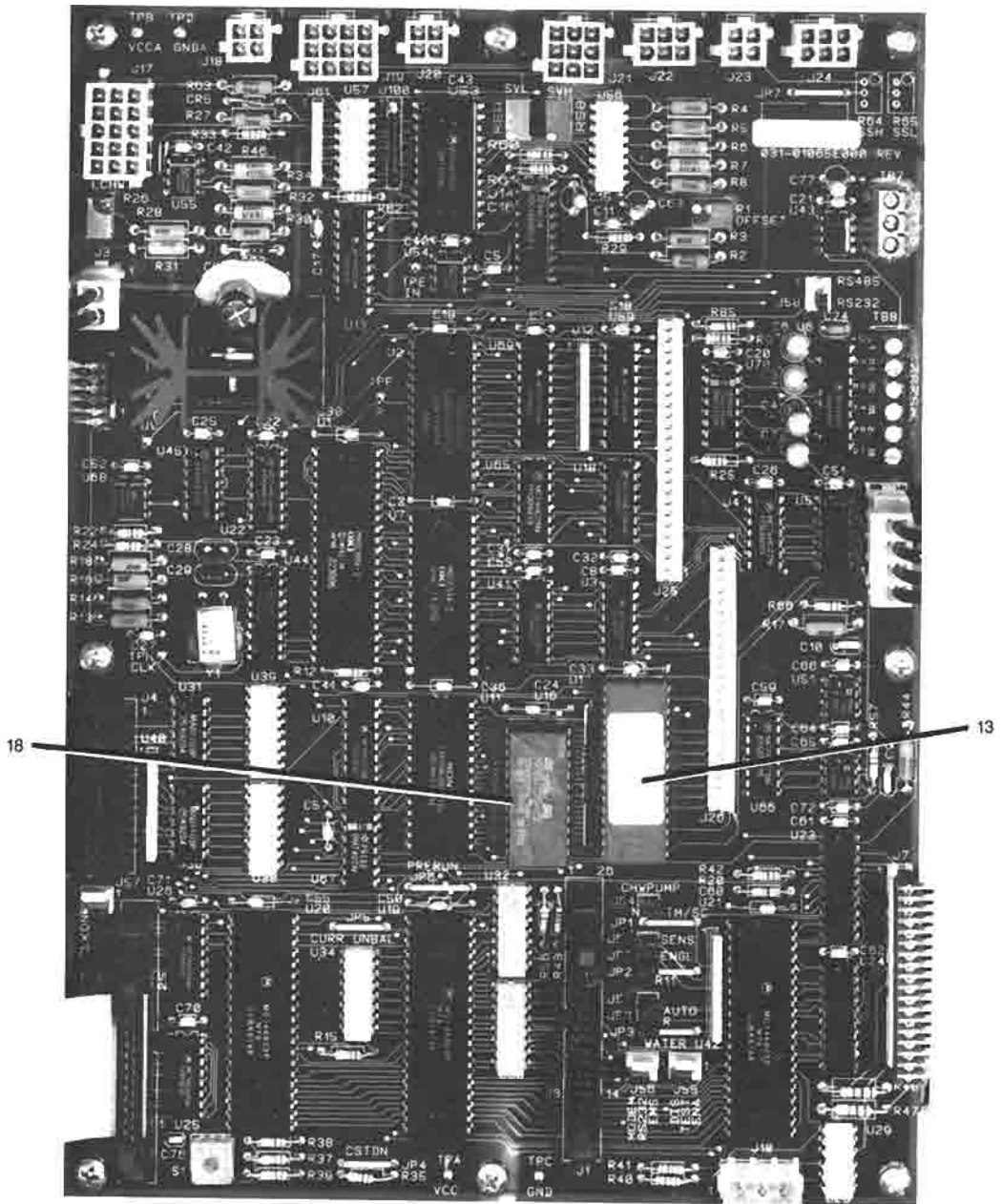

FIG.4

○ PUMP MOTOR CONTACTORS

PUMP MFR	STARTER	PUMP	VOLTAGE CODE	UNIT SIZE												
				15GL	16G	16GL	17G	18G	19G	19GL	20G	21G	22G	22GL		
BUFFALO	1M	SOLUTION P1	17	024-25585-000	024-25585-000	024-25585-000	024-25585-000	024-25585-000	024-25585-000	024-25585-000	024-25585-000	024-25585-000	024-25585-000	024-25585-000		
			28	024-25585-000	024-25585-000	024-25585-000	024-25585-000	024-25585-000	024-25585-000	024-25585-000	024-25585-000	024-25585-000	024-25585-000	024-25585-000	024-25585-000	
			46	024-25584-000	024-25584-000	024-25584-000	024-25584-000	024-25584-000	024-25584-000	024-25584-000	024-25584-000	024-25584-000	024-25584-000	024-25584-000	024-25584-000	
	2M	REFRIGERANT P3	17	024-25526-000	024-25526-000	024-25526-000	024-25526-000	024-25526-000	024-25526-000	024-25526-000	024-25526-000	024-25526-000	024-25526-000	024-25526-000	024-25526-000	
			28	024-25526-000	024-25526-000	024-25526-000	024-25526-000	024-25526-000	024-25526-000	024-25526-000	024-25526-000	024-25526-000	024-25526-000	024-25526-000	024-25526-000	
			46	024-25521-000	024-25521-000	024-25521-000	024-25521-000	024-25521-000	024-25521-000	024-25521-000	024-25521-000	024-25521-000	024-25521-000	024-25521-000	024-25521-000	
	3M	PURGE	17	024-25522-000	024-25522-000	024-25522-000	024-25522-000	024-25522-000	024-25522-000	024-25522-000	024-25522-000	024-25522-000	024-25522-000	024-25522-000	024-25522-000	
			28	024-25522-000	024-25522-000	024-25522-000	024-25522-000	024-25522-000	024-25522-000	024-25522-000	024-25522-000	024-25522-000	024-25522-000	024-25522-000	024-25522-000	
			46	024-25522-000	024-25522-000	024-25522-000	024-25522-000	024-25522-000	024-25522-000	024-25522-000	024-25522-000	024-25522-000	024-25522-000	024-25522-000	024-25522-000	
	4M	SPRAY PUMP 1 (WEAK SOLUTION) P4	17								024-25526-000	024-25526-000	024-25526-000	024-25526-000	024-25526-000	
			28								024-25526-000	024-25526-000	024-25526-000	024-25526-000	024-25526-000	
			46								024-25521-000	024-25521-000	024-25521-000	024-25521-000	024-25521-000	
	5M	SPRAY PUMP 2 (STRONG SOLUTION) P2	17								024-25526-000	024-25585-000	024-25526-000	024-25526-000	024-25526-000	
			28								024-25526-000	024-25585-000	024-25526-000	024-25526-000	024-25526-000	
			46								024-25521-000	024-25584-000	024-25521-000	024-25521-000	024-25521-000	
	NIKKISO	1M	SOLUTION P1	17	024-25584-000	024-25583-000	024-25583-000	024-25583-000	024-25585-000	024-25585-000	024-25583-000	024-25585-000	024-25585-000	024-25585-000	024-25585-000	
				28	024-25584-000	024-25583-000	024-25583-000	024-25583-000	024-25584-000	024-25584-000	024-25583-000	024-25585-000	024-25585-000	024-25585-000	024-25585-000	024-25585-000
				46	024-25526-000	024-25584-000	024-25584-000	024-25584-000	024-25584-000	024-25584-000	024-25584-000	024-25584-000	024-25584-000	024-25584-000	024-25584-000	024-25584-000
2M		REFRIGERANT P3	17	024-25522-000	024-25521-000	024-25521-000	024-25521-000	024-25521-000	024-25521-000	024-25521-000	024-25521-000	024-25521-000	024-25526-000	024-25526-000	024-25526-000	
			28	024-25522-000	024-25521-000	024-25521-000	024-25521-000	024-25521-000	024-25521-000	024-25521-000	024-25521-000	024-25521-000	024-25526-000	024-25526-000	024-25526-000	
			46	024-25522-000	024-25522-000	024-25522-000	024-25522-000	024-25522-000	024-25522-000	024-25522-000	024-25522-000	024-25522-000	024-25526-000	024-25526-000	024-25526-000	
3M		PURGE	17	024-25522-000	024-25522-000	024-25522-000	024-25522-000	024-25522-000	024-25522-000	024-25522-000	024-25522-000	024-25522-000	024-25522-000	024-25522-000	024-25522-000	
			28	024-25522-000	024-25522-000	024-25522-000	024-25522-000	024-25522-000	024-25522-000	024-25522-000	024-25522-000	024-25522-000	024-25522-000	024-25522-000	024-25522-000	
			46	024-25522-000	024-25522-000	024-25522-000	024-25522-000	024-25522-000	024-25522-000	024-25522-000	024-25522-000	024-25522-000	024-25522-000	024-25522-000	024-25522-000	
4M		SPRAY PUMP 1 (WEAK SOLUTION) P4	17								024-25584-000	024-25521-000	024-25584-000	024-25583-000	024-25583-000	
			28								024-25584	024-25521-000	024-25584-000	024-25583-000	024-25583-000	
			46								024-25526	024-25522-000	024-25526-000	024-25584-000	024-25584-000	
5M		SPRAY PUMP 2 (STRONG SOLUTION) P2	17								024-25521-000	024-25584-000	024-25584-000	024-25584-000	024-25584-000	
			28								024-25521-000	024-25584-000	024-25584-000	024-25584-000	024-25584-000	
			46								024-25522-000	024-25526-000	024-25526-000	024-25526-000	024-25526-000	

7 (S) = Recommended Stock Spare Part
Contactors Include Suppressors

POWER PANEL

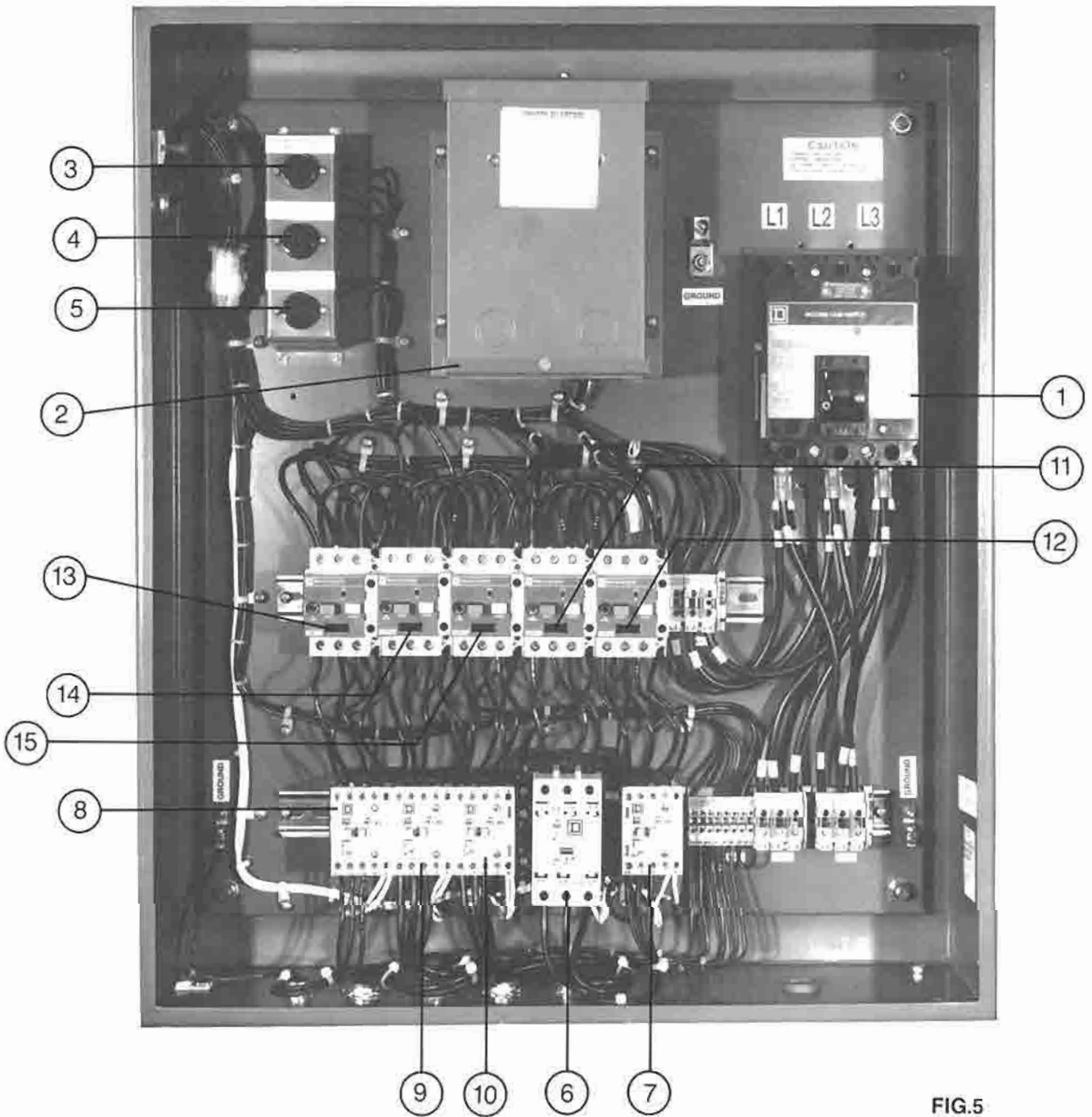

FIG.5

NOTE: Control Panel Shown is for Units with Spray Pumps.

CONTROL COMPONENTS—POWER PANEL (SEE FIG. 5)

Form 155.17-RP1

ITEM NO.	QTY PER UNIT	DESCRIPTION	VOLT CODE	PART NUMBER	UNIT MODEL												
					15GL	16G	16GL	17G	18G	19G	19GL	20G	21G	22G	22GL		
1	1	POWER DISCONNECT SWITCH	17	024-25565-000								X	X	X	X	X	
			28	024-25575-000	X	X	X	X	X	X							
			46	024-25565-000									X	X	X	X	X
			46	024-25575-000	X	X	X	X	X	X							
			46	024-25565-000	X	X	X	X	X	X	X	X	X	X	X	X	
X = Correct Part No. for Unit Size																	
2	1	CONTROL TRANSFORMER	17	025-28664-001													
			28	025-28664-002													
			46	025-28664-002													
3	1	FUSES PRIMARY 1FU	(12 Amps) 17	025-27972-000													
			(10 Amps) 28	025-27971-000													
			(5 Amps) 46	025-27922-000													
4	1	2FU	(12 Amps) 17	025-27972-000													
			(10 Amps) 28	025-27971-000													
			(5 Amps) 46	025-27922-000													
5	1	3FU	(10 Amps) ALL	025-27971-000													
6	1	CONTACTORS 1M SOLUTION (P1)		SEE PAGE 7													
7	1	2M REFRIGERANT (P3)															
8	1	3M PURGE															
9	1	4M SPRAY PUMP 1 (P4) (WEAK SOLUTION)															
10	1	5M SPRAY PUMP 2 (P2) (STRONG SOLUTION)															
11	1	OVERLOAD ASSEMBLIES 10L SOLUTION (P1)		SEE PAGE 10													
12	1	20L REFRIGERANT (P3)															
13	1	30L PURGE															
14	1	40L SPRAY PUMP 1 (P4) (WEAK SOLUTION)															
15	1	50L SPRAY PUMP 2 (P2) (STRONG SOLUTION)															

SYSTEM CONTROL COMPONENTS (NOT SHOWN)

ITEM NO.	QTY PER UNIT	DESCRIPTION	TYPE UNIT USED ON	PART NUMBER
1	1	LOW SOLUTION LEVEL SWITCH KIT	DF	225-29922-000
2	1	PRESSURE TRANSDUCER	ALL	025-29907-001
3	1	ISOLATOR (USE WITH ITEM 2)	ALL	026-30229-000
4	1	1st STAGE GENERATOR HIGH PRESSURE CONTROL (CALIBRATED)	ALL	224-25525-058
5	1	1st STAGE HIGH TEMP. CONTROLLER	ALL	025-29995-000
6	1	LOW REFRIG. TEMP. CONTROLLER	ALL	025-29923-000
7	2	TEMPERATURE SENSOR (50K)*	ALL	025-29924-000
8	7	TEMPERATURE SENSOR (3K)	DF	025-28935-000
9	5	TEMPERATURE SENSOR (3K)	ST	025-28935-000
9	1	CONTROL RELAY, 3PDT	ALL	024-23962-000
10	1	SUPPRESSOR	DF	031-00808-000
10	2	SUPPRESSOR	ST	031-00808-000
11	2	METAL OXIDE VARISTOR	ST	031-01349-000

LEGEND
 DF=DIRECT-FIRED UNIT
 ST=STEAM UNIT

* Used for 1st Stage Generator Temperature and Solution Dilution Temperature

PUMP MOTOR OVERLOAD (ASSEMBLIES)

PUMP MFR	OVERLOAD	PUMP	VOLTAGE CODE	UNIT SIZE											
				15GL	16G	16GL	17G	18G	19G	19GL	20G	21G	22G	22GL	
BUFFALO	10L	SOLUTION P1	17	024-25581-000	024-25581-000	024-25581-000	024-25581-000	024-25581-000	024-25581-000	024-25581-000	024-25581-000	024-25581-000	024-25581-000	024-25581-000	
			28	024-25581-000	024-25581-000	024-25581-000	024-25581-000	024-25581-000	024-25581-000	024-25581-000	024-25581-000	024-25581-000	024-25581-000	024-25581-000	024-25581-000
			46	024-25580-000	024-25587-000	024-25587-000	024-25587-000	024-25580-000	024-25580-000	024-25587-000	024-25580-000	024-25580-000	024-25580-000	024-25580-000	024-25580-000
	20L	REFRIGERANT P3	17	024-25587-000	024-25587-000	024-25587-000	024-25587-000	024-25587-000	024-25587-000	024-25587-000	024-25587-000	024-25587-000	024-25587-000	024-25587-000	024-25587-000
			28	024-25587-000	024-25587-000	024-25587-000	024-25587-000	024-25587-000	024-25587-000	024-25587-000	024-25587-000	024-25587-000	024-25587-000	024-25587-000	024-25587-000
			46	024-25578-000	024-25578-000	024-25578-000	024-25578-000	024-25578-000	024-25578-000	024-25578-000	024-25578-000	024-25579-000	024-25578-000	024-25579-000	024-25579-000
	30L	PURGE	17	024-25576-000	024-25576-000	024-25576-000	024-25576-000	024-25576-000	024-25576-000	024-25576-000	024-25576-000	024-25576-000	024-25576-000	024-25576-000	024-25576-000
			28	024-25576-000	024-25576-000	024-25576-000	024-25576-000	024-25576-000	024-25576-000	024-25576-000	024-25576-000	024-25576-000	024-25576-000	024-25576-000	024-25576-000
			46	024-25586-000	024-25586-000	024-25586-000	024-25586-000	024-25586-000	024-25586-000	024-25586-000	024-25586-000	024-25586-000	024-25586-000	024-25586-000	024-25586-000
	40L	SPRAY PUMP 1 (WEAK SOLUTION) P4	17								024-25587-000	024-25587-000	024-25587-000	024-25587-000	024-25587-000
			28								024-25587-000	024-25587-000	024-25587-000	024-25587-000	024-25587-000
			46								024-25578-000	024-25579-000	024-25579-000	024-25579-000	024-25579-000
50L	SPRAY PUMP 2 (STRONG SOLUTION) P2	17								024-25587-000	024-25581-000	024-25587-000	024-25587-000	024-25587-000	
		28								024-25587-000	024-25581-000	024-25587-000	024-25587-000	024-25587-000	
		46								024-25578-000	024-25580-000	024-25579-000	024-25579-000	024-25579-000	
NIKKISO	10L	SOLUTION P1	17	024-25580-000	024-25581-000	024-25581-000	024-25581-000	024-25582-000	024-25582-000	024-25581-000	024-25582-000	024-25582-000	024-25582-000	024-25582-000	
			28	024-25580-000	024-25581-000	024-25581-000	024-25581-000	024-25582-000	024-25582-000	024-25581-000	024-25582-000	024-25582-000	024-25582-000	024-25582-000	024-25582-000
			46	024-25579-000	024-25580-000	024-25580-000	024-25580-000	024-25581-000	024-25581-000	024-25580-000	024-25581-000	024-25581-000	024-25581-000	024-25581-000	024-25581-000
	20L	REFRIGERANT P3	17	024-25578-000	024-25579-000	024-25579-000	024-25579-000	024-25579-000	024-25579-000	024-25579-000	024-25579-000	024-25587-000	024-25579-000	024-25587-000	024-25587-000
			28	024-25578-000	024-25579-000	024-25579-000	024-25579-000	024-25579-000	024-25579-000	024-25579-000	024-25579-000	024-25587-000	024-25579-000	024-255987-000	024-25587-000
			46	024-25577-000	024-25578-000	024-25578-000	024-25578-000	024-25578-000	024-25578-000	024-25578-000	024-25578-000	024-25578-000	024-25578-000	024-25578-000	024-25578-000
	30L	PURGE	17	024-25576-000	024-25576-000	024-25576-000	024-25576-000	024-25576-000	024-25576-000	024-25576-000	024-25576-000	024-25576-000	024-25576-000	024-25576-000	024-25576-000
			28	024-25576-000	024-25576-000	024-25576-000	024-25576-000	024-25576-000	024-25576-000	024-25576-000	024-25576-000	024-25576-000	024-25576-000	024-25576-000	024-25576-000
			46	024-25586-000	024-25586-000	024-25586-000	024-25586-000	024-25586-000	024-25586-000	024-25586-000	024-25586-000	024-25586-000	024-25586-000	024-25586-000	024-25586-000
	40L	SPRAY PUMP 1 (WEAK SOLUTION) P4	17								024-25580-000	024-25587-000	024-25580-000	024-25581-000	024-25581-000
			28								024-25580-000	024-25587-000	024-25580-000	024-25581-000	024-25581-000
			46								024-25579-000	024-25578-000	024-25579-000	024-25580-000	024-25580-000
50L	SPRAY PUMP 2 (STRONG SOLUTION) P2	17								024-25587-000	024-25580-000	024-25580-000	024-25580-000	024-25580-000	
		28								024-25587-000	024-25580-000	024-25580-000	024-25580-000	024-25580-000	
		46								024-25578-000	024-25579-000	024-25579-000	024-25579-000	024-25579-000	

TUBES

UNIT SIZE	TUBE OPTION	SHELL LOCATION OF TUBES			
		CONDENSER	SECOND STAGE GENERATOR	EVAPORATOR	ABSORBER
15GL	S	007-08000-000	007-08004-000	007-08077-000	007-08015-000
	A	007-08000-000	007-08004-000	007-08077-000	007-08076-000
	B	007-08000-000	007-08004-000	007-07899-000	007-08015-000
	C	007-08000-000	007-08004-000	007-07899-000	007-08076-000
16G	S	007-08000-000	007-08004-000	007-08077-000	007-08076-000
	A	007-08000-000	007-08004-000	007-07899-000	007-07898-000
	B	007-08000-000	007-08004-000	007-07899-000	007-08076-000
	C	007-08000-000	007-08004-000	007-07899-000	007-07898-000
16GL	S	007-08001-000	007-08005-000	007-08079-000	007-08016-000
	A	007-08001-000	007-08005-000	007-08079-000	007-08082-000
	B	007-08001-000	007-08005-000	007-08011-000	007-08016-000
	C	007-08001-000	007-08005-000	007-08011-000	007-08082-000
17G	S	007-08001-000	007-08005-000	007-08079-000	007-08082-000
	A	007-08001-000	007-08005-000	007-08011-000	007-08021-000
	B	007-08001-000	007-08005-000	007-08011-000	007-08082-000
	C	007-08001-000	007-08005-000	007-08011-000	007-08021-000
18G	S	007-08002-000	007-08006-000	007-08080-000	007-08083-000
	A	007-08002-000	007-08006-000	007-08012-000	007-08022-000
	B	007-08002-000	007-08006-000	007-08012-000	007-08083-000
	C	007-08002-000	007-08006-000	007-08012-000	007-08022-000
19G	S	007-08003-000	007-08007-000	007-08081-000	007-08084-000
	A	007-08003-000	007-08007-000	007-08013-000	007-08023-000
	B	007-08003-000	007-08007-000	007-08013-000	007-08084-000
	C	007-08003-000	007-08007-000	007-08013-000	007-08023-000
19GL	S	007-07894-000	007-07895-000	007-08078-000	007-07897-000
	A	007-07894-000	007-07895-000	007-08078-000	007-08085-000
	B	007-07894-000	007-07895-000	007-08014-000	007-07897-000
	C	007-07894-000	007-07895-000	007-08014-000	007-08085-000
20G	S	007-07894-000	007-07895-000	007-08078-000	007-07897-000
	A	007-07894-000	007-07895-000	007-08078-000	007-08085-000
	B	007-07894-000	007-07895-000	007-08014-000	007-07897-000
	C	007-07894-000	007-07895-000	007-08014-000	007-08085-000
21G	S	007-07894-000	007-07895-000	007-08078-000	007-07897-000
	A	007-07894-000	007-07895-000	007-08078-000	007-08085-000
	B	007-07894-000	007-07895-000	007-08014-000	007-07897-000
	C	007-07894-000	007-07895-000	007-08014-000	007-08085-000
22G	S	007-07894-000	007-07895-000	007-08078-000	007-07897-000
	A	007-07894-000	007-07895-000	007-08078-000	007-08085-000
	B	007-07894-000	007-07895-000	007-08014-000	007-07897-000
	C	007-07894-000	007-07895-000	007-08014-000	007-08085-000
22GL	S	007-07894-000	007-07895-000	007-08078-000	007-07897-000
	A	007-07894-000	007-07895-000	007-08078-000	007-08085-000
	B	007-07894-000	007-07895-000	007-08014-000	007-07897-000
	C	007-07894-000	007-07895-000	007-08014-000	007-08085-000

PUMPS

BUFFALO (208-230/460-3-60)			YORK PART NUMBER			
UNIT SIZE	BUFFALO PUMP		REFRIGERANT PUMP (P3)	SOLUTION PUMP (P1)	WEAK SOLUTION PUMP # 1 (P4)	STRONG SOLUTION PUMP # 2 (P2)
	PART NO.	SIZE				
15GL	YK709-03 YK8011-04	66M 709 66M 709	026-32304-014	026-32304-006		
16G	YK709-04 YK8011-05	66M 709 215R 8011	026-32304-015	026-32304-007		
16GL	YK709-04 YK8011-05	66M 709 215R 8011	026-32304-015	020-32304-007		
17G	YK709-04 YK8011-05	66M 709 215R 8011	026-32304-015	026-32304-007		
18G	YK709-04 YK8011-08	66M 709 215Z 8011	026-32304-015	026-32304-010		
19G	YK709-04 YK8011-08	66M 709 215Z 8011	026-32304-15	026-32304-010		
19GL	YK709-04 YK8011-06 YK709-01 YK709-02	66M 709 215R 8011 66M 709 66M 709	026-32304-015	026-32304-008	026-32304-002	026-32304-005
20G	YK8011-12 YK8011-09 YK8011-01 YK8011-11	66V 8011 215Z 8011 66V 8011 215Z 8011	026-32304-016	026-32304-011	026-32304-001	026-32304-013
21G	YK709-04 YK8011-10 YK8011-03 YK8011-02	66M 709 215Z 8011 66V 8011 66V 8011	026-32304-015	026-32304-012	026-32304-004	026-32304-003
22G	YK8011-12 YK8011-10 YK8011-07 YK8011-02	66V 8011 215Z 8011 66V 8011 66V 8011	020-32304-016	026-32304-012	026-32304-009	026-32304-003
22GL	— — —	— — —	—	—	—	—

NIKKISO (208-230/460-3-60)			YORK PART NUMBER			
UNIT SIZE	NIKKISO MODEL NO.	REFRIGERANT PUMP (P3)	SOLUTION PUMP (P1)	WEAK SOLUTION PUMP # 1 (P4)	STRONG SOLUTION PUMP # 2 (P2)	
15GL	S291-0.8E-A SS231-4.5H-A-2	026-32007-030	026-32007-149			
16G	S291-1.5E-A SS491-5.5H-A	026-32007-034	026-32007-073			
16GL	S291-1.5E-A SS491-5.5H-A	026-32007-034	026-32007-073			
17G	S291-1.5E-A SS491-5.5H-A	026-32007-034	026-32007-073			
18G	S291-1.5E-A SS491-7.5C-A	026-32007-034	026-32007-077			
19G	S291-1.5E-A SS491-7.5C-A	026-32007-034	026-32007-077			

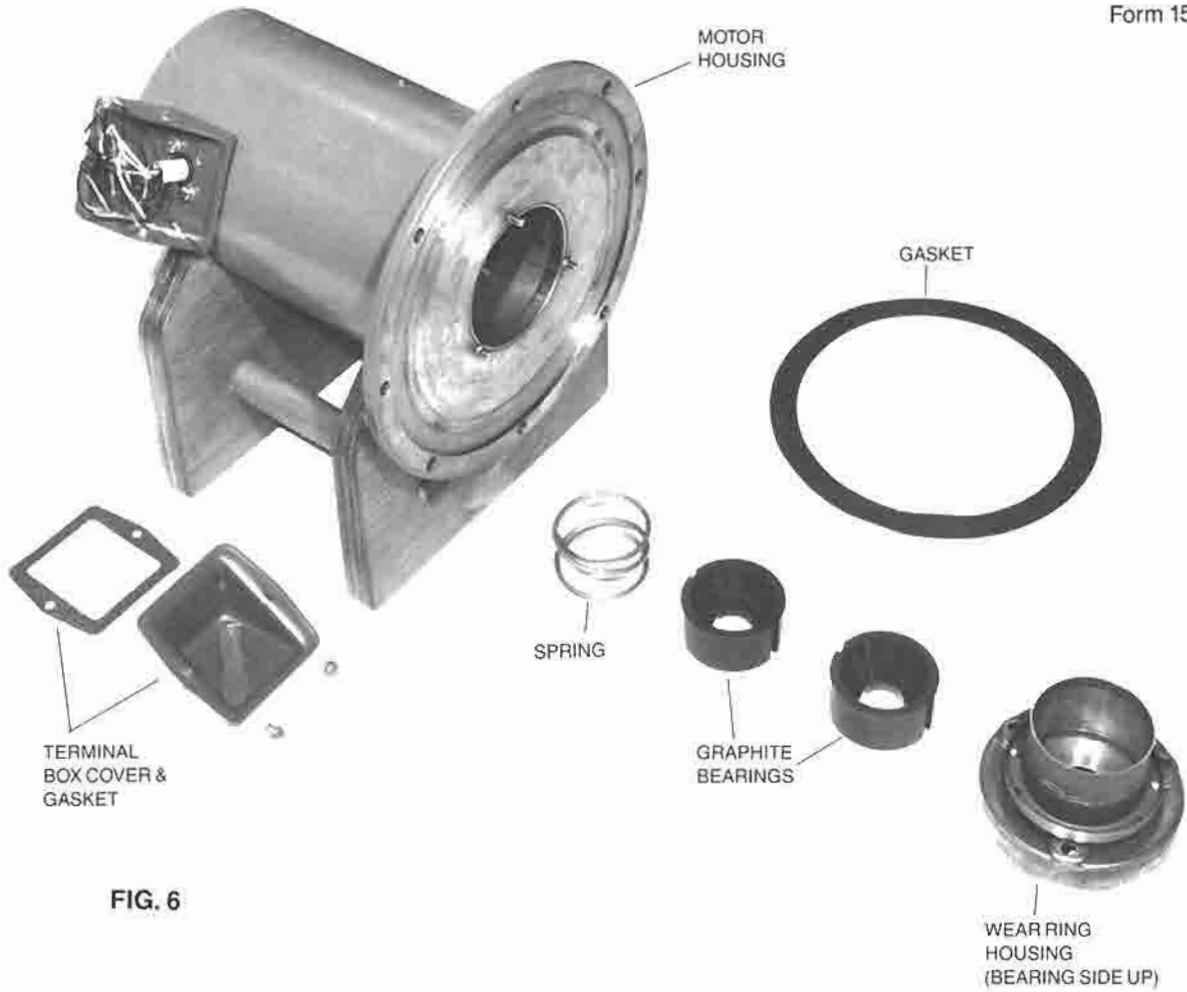

PUMPS (CONT.)

NIKKISO (208-230/460-3-60) (CONT)		YORK PART NUMBER			
UNIT SIZE	NIKKISO MODEL NO.	REFRIGERANT PUMP (P3)	SOLUTION PUMP (P4)	WEAK SOLUTION PUMP #1 (P4)	STRONG SOLUTION PUMP #2 (P2)
19GL	S291-1.5E-A SS491-5.5H-A-1 SS491-3.7H-A-1 S291-2.2H-A-1	026-32007-034	026-32007-123	026-32007-133	026-32007-145
20G	S491-1.5E-A SS491-7.5C-A-2 S491-1.5H-A SS230-3.7H-A-1	026-32007-038	026-32007-132	026-32007-062	026-32007-153
21G	S291-1.5E-A SS491-7.5H-A-1 SS491-3.7H-A-3 SS491-3.7H-A-2	026-32007-034	026-32007-131	026-32007-063	026-32007-140
22G	S491-1.5E-A SS491-7.5H-A-1 SS491-5.5H-A-3 SS491-3.7H-A-2	026-32007-038	026-32007-131	026-32007-124	026-32007-140
22GL	— — — —	—	—	—	—

NOTE: DUAL—VOLTAGE PUMPS ARE TO BE USED AS REPLACEMENTS FOR ALL PUMPS, INCLUDING SINGLE VOLTAGE PUMPS.

PUMP SERVICE KITS

NIKKISO		
TYPE OF KIT	PUMP MODEL	YORK KIT PART NUMBER
PUMP OVERHAUL KIT*	SS221-5.5	026-32007-011
PUMP OVERHAUL KIT*	SS491-3.7	026-32007-012
PUMP OVERHAUL KIT*	SS491-5.5	026-32007-012
PUMP OVERHAUL KIT*	SS491-7.5	026-32007-012
PUMP OVERHAUL KIT*	SS491-1.5	026-32007-013
PUMP OVERHAUL KIT*	S491-1.5	026-32007-014
NIKKISO		
TYPE OF KIT	PUMP MODEL	YORK KIT PART NUMBER
PUMP OVERHAUL KIT*	S291-0.8	026-32007-008
PUMP OVERHAUL KIT*	S291-1.5	026-32007-008
PUMP OVERHAUL KIT*	S292-0.8	026-32007-008
PUMP OVERHAUL KIT*	S292-1.5	026-32007-008
PUMP OVERHAUL KIT*	S291-2.2	026-32007-009
PUMP OVERHAUL KIT*	S230-3.7	026-32007-010
PUMP OVERHAUL KIT*	SS230-4.5	026-32007-010
PUMP OVERHAUL KIT*	SS231-3.7	026-32007-010
PUMP OVERHAUL KIT*	SS231-4.5	026-32007-010
BUFFALO		
TYPE OF KIT	PUMP MODEL	YORK KIT PART NUMBER
PUMP KIT†	YK709	026-32389-000
PUMP KIT†	YK8011	026-32390-000
MOTOR BEARING KIT††	MOTOR 66M	026-32391-000
MOTOR BEARING KIT††	MOTOR 66V	026-32391-000
MOTOR BEARING KIT††	MOTOR 215R	026-32392-000
MOTOR BEARING KIT††	MOTOR 215Z	026-32392-000

* EACH KIT CONTAINS THE FOLLOWING:

(2) BEARINGS, (2) GASKETS, (2) TAB LOCK WASHERS, (2) SHAFT SLEEVES, (2) THRUST COLLARS, (2 SETS) TEFLON BEARING SHIELDS, (2) ALLEN SCREWS, (2) FIBER ISOLATORS, AND (2) S.S. BEARING SHIELDS

† KIT PUMP SERVICE FOR BUFFALO PUMP MODEL YK709, CONSISTING ONE EACH OF: CASING WEAR RING, MOTOR WEAR RING, IMPELLER LOCKING SCREW, IMPELLER LOCKING WASHER, IMPELLER KEY, AND CASING GASKET.

†† KIT, MOTOR BRG KIT FOR BUFFALO PUMP MOTOR 66M 8 66V, CONSISTING ONE EACH OF: FRONT BEARING, BEARING, REVN-, 0693-3024, 02/16/93

VALVES

TYPE	SIZE NOMENCLATURE	YORK PART NUMBER
BALL	1/4" 3/8" 3/4"	022-08885-001 022-08885-003 022-08885-004
BUTTERFLY (SEE FIG. 8)	4" 6"	022-08877-000 022-08878-000
CHECK (SEE FIG. 9)	1/2" BALL CONE	022-08880-000
DIAPHRAGM	1/2" WEIR TYPE	022-08869-052
FLOW SETTING (SEE FIG. 10 & 10A)	1/2" AV0200 MODEL TAC 15A 1 1/2" AV0400 MODEL TAC 40A	022-08869-002 022-08869-000

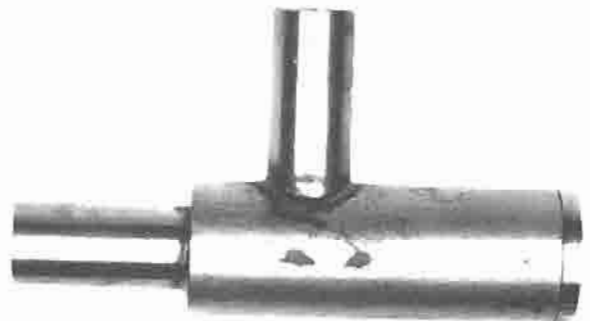
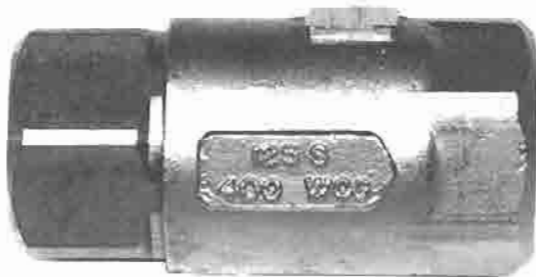

GLOBE (SEE FIG. 11)	1/2"	MODEL TAC 15A	022-08869-050
	3/4"	MODEL TAC 20A	022-08869-053
	1"	MODEL TAC 25A	022-08869-051
	1 1/2"	GV0100 MODEL TAC 40A	022-08869-028
	2"	GV0200 MODEL TAC 50V	022-08869-030
	2 1/2"	GV0300 MODEL TAC 65V	022-08869-031
	3"	GV0400 MODEL TAC 80A	022-08869-032
	4"	GV0500 MODEL TAC 100A	022-08869-033
NEEDLE (SEE FIG. 12)	3/4"		022-08891-000
	1"		022-08892-000
RELIEF	3/4"		022-08879-000
SAMPLING (SEE FIG. 13 & 13A)	1/2"	AV0100 MODEL TAC 15A	022-08869-001
STEAM CONTROL	2"	W/150# FLANGES	022-08889-000
	2 1/2"	W/150# FLANGES	022-08888-000
	3"	W/150# FLANGES	022-08887-000
	4"	W/150# FLANGES	022-08886-000
	4"	W/300# FLANGES	022-08899-000
STEAM SOLENOID	3/4"		025-29538-002
	1"		025-29538-003
	1 1/4"		025-29538-004



FIG. 11



FIG. 12



FIG. 13



FIG. 14

See Miscellaneous Components Item 16.

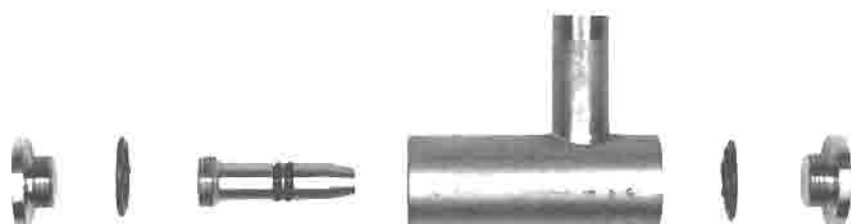

FIG. 13A

WATER HEATER (Direct-Fired Unit Only)

UNIT SIZE	WATER TEMP	PASS	TUBES		WATER HEAD GASKET		CHANNEL GASKET*	
			QUANT	PART NUMBER	QUANT	PART NUMBER	QUANT	PART NUMBER
15GL	STD	1 2 3						
	HIGH	1 2 3						
16G	STD	1 2 3	180	007-08024-000	9 FT	028-03242-000		
	HIGH	1 2 3	336 336	007-08024-000 007-08024-000	11 FT 11 FT	028-03242-000 028-03242-000	2 4	FT 028-09951-000 FT 028-09951-000
16GL	STD	1 2 3						
	HIGH	1 2 3						
17G	STD	1 2 3	180 180	007-08024-000 007-08024-000	9 FT 9 FT	028-03242-000 028-03242-000	2 2	FT 028-09951-000 FT 028-09951-000
	HIGH	1 2 3	394 394	007-08024-000 007-08024-000	12 FT 12 FT	028-03242-000 028-03242-000	2 4	FT 028-09951-000 FT 028-09951-000
18G	STD	1 2 3						
	HIGH	1 2 3	550 550	007-08024-000 007-08024-000	13 FT 13 FT	028-03242-000 028-03242-000	2.125 4.25	FT 028-09951-000 FT 028-09951-000
19G	STD	1 2 3						
	HIGH	1 2 3	550	007-08024-000	13 FT	028-03242-000	4.25	FT 028-09951-000

*See MISCELLANEOUS COMPONENTS, ITEM 8, ADHESIVE

WATER BOX (150# COMPACT) GASKETS*

UNIT SIZE	EVAP/ABSORB PASS COMBINATIONS	GASKET PART NUMBER(S)	TOTAL LENGTH REQUIRED FOR ALL UNIT WATER BOXES	
			OLD DESIGN	NEW DESIGN
15G THRU 19GL	ALL	028-09951-000	48 FT	52 FT
20 G	2E/1A	028-03242-000 028-09951-000		57 FT 2.5 FT
21G	2E/1A	028-03242-000 028-09951-000		64 FT 3 FT
22G	2E/1A	028-03242-000 028-09951-000		74 FT 2 FT

*See MISCELLANEOUS COMPONENTS, ITEM 8, ADHESIVE

MISCELLANEOUS COMPONENTS

ITEM	DESCRIPTION	PART NUMBER
1.	LITHIUM BROMIDE SOLUTION NITRATE INHIBITED, 30 gal Drum	011-00524-001
1A.	LITHIUM BROMIDE SOLUTION, MOLYBDATE INHIBITED, 30 gal Drum	011-00556-000
2.	LITHIUM NITRATE, 1 lb Bag	011-00524-002
2A.	LITHIUM MOLYBDATE, 1 lb Bag	011-00557-000
3.	LITHIUM HYDROXIDE MONOHYDRATE, 5 lb	044-02985-000
4.	ALCOHOL, 18 Liters	011-00524-003
5.	FLOW SWITCH, For Use W/150 # Water Boxes	024-15793-000
6.	FLOW SWITCH, For Use W/300 # Water Boxes	024-12144-000
8.	ADHESIVE, Gasket, 5 oz Tube (For Water Box Gaskets)	013-00995-000
9.	PRIMER (LOKTITE PRIMER N), 6 oz Aerosol Can Carib Blue	013-01753-000
10.	PAINT, Touchup, 16 oz Aerosol Can	013-01835-000
11.	SEALANT, Vacuum, 4 oz Can	013-02882-003
12.	SEALANT, PST 567, 250 ml Tube	013-02280-000
13.	VACUUM GREASE, Silicone, 5.3 oz Tube	
14.	VACUUM PUMP OIL 1 Gallon	011-00524-004
15.	SIGHT PLUG, 2" (Threaded)	026-18004-000
16.	RUPTURE DISK, 6" (with gaskets)	026-32007-016
17.	GAUGE, Compound, 3 1/2", 30" Hg-0-30psig	026-32300-000
18.	GAUGE, Compound, 3 1/2", 30" Hg-0-300psig	026-03952-000
28.	ABSOLUTE PRESSURE GAUGE, Glass Mercury-Filled U-Tube, 5" Std cm/mm, Gauge Range 127mm	026-09261-000
29.	ABSOLUTE PRESSURE GAUGE, Dial-Type (Non-Mercury), Gauge Range 0 to 40mm Absolute	026-32396-000
30.	TUBING, Vacuum g x 1/4ID x 5/8OD, Tygon	028-12514-000
31.	VACUUM PUMP	026-32305-000
32.	VACUUM PUMP SEAL KIT	026-32388-000
	LEAK TEST KIT REPLACEMENT PARTS	
32.	POLYPROPYLENE CYLINDER	044-02982-000
33.	PLASTIC TUBING, 72Lg x 3/8OD x 1/4ID	028-05034-000
34.	HOSE, Vacuum Pump 12 x 13/16ID	028-07720-000
35.	ALLEN WRENCH, 22mm, For Spindle Valves	029-20981-000
36.	REFRIGERANT REMOVAL TANK	026-32007-002
37.	THERMOMETER, 0-23F, 12 Inch (Spirit Filled)	026-32364-000
38.	THERMOMETER, 0-500F, 15 Inch (Spirit Filled)	026-32365-000
39.	HYDROMETER KIT, Case and Set of 8 (Items 40 through 47)	026-32366-000
40.	HYDROMETER, .700 to .810 Specific Gravity	026-32366-001
41.	HYDROMETER, .800 to .910 Specific Gravity	026-32366-002
42.	HYDROMETER, .900 to 1.010 Specific Gravity	026-32366-003
43.	HYDROMETER, 1.000 to 1.220 Specific Gravity	026-32366-004
44.	HYDROMETER, 1.200 to 1.420 Specific Gravity	026-32366-005
45.	HYDROMETER, 1.400 to 1.620 Specific Gravity	026-32366-006
46.	HYDROMETER, 1.600 to 1.820 Specific Gravity	026-32366-007
48.	HYDROMETER, 1.800 to 2.000 Specific Gravity	026-32366-008

MISCELLANEOUS GASKETS

ITEM	DESCRIPTION	PART NUMBER
21.	GASKET, Round, 2 5/8", Drain Cooler	028-10386-003
22.	GASKET, Round, 3", Drain Cooler Piping	028-10386-004
23.	GASKET, Round, 3 5/8", Drain Cooler Piping	028-10386-005
24.	GASKET, Round, 4 1/8", Steam Generator to Drain Cooler GASKET, 1st Stage Steam Generator Head	028-10386-006
	UNIT SIZE	
25.	18G, 19G, 20G	028-12517-000
26.	21G	028-12521-000
27.	22G, 22GL	028-12510-000

