

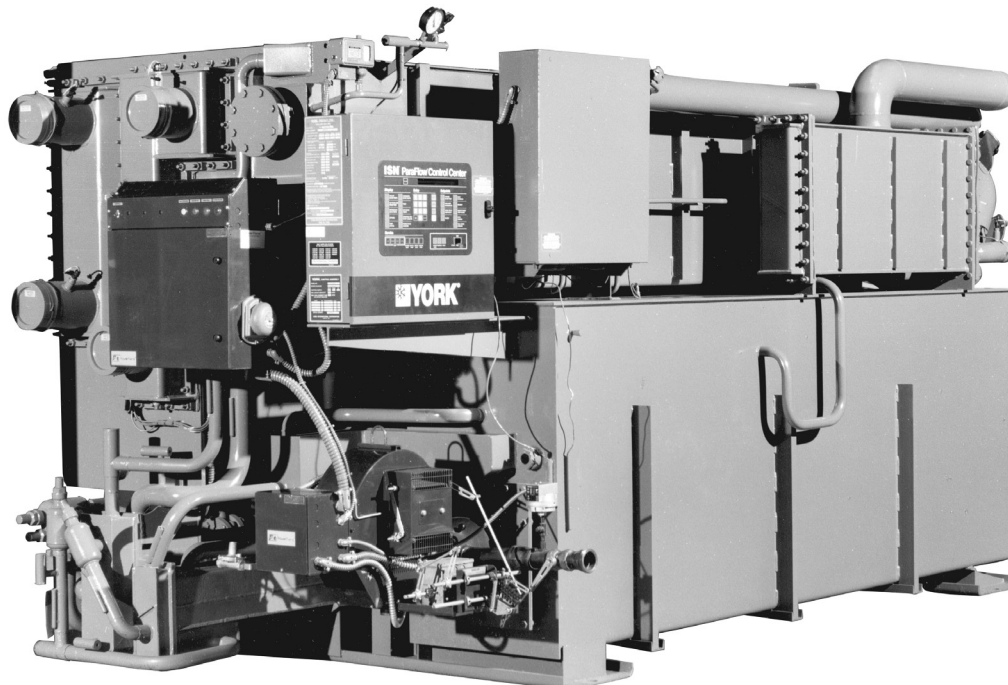

BY JOHNSON CONTROLS



***Model YPC ParaFlow Two-Stage Direct-Fired Absorption
Chiller-Heaters
Style D***

**Models YPC-DF-12SC through YPC-DF-19S
200 through 675 Tons
703 kW through 2372 kW**

Contents	
FORM 155.17-EG4 (1111)	1
Introduction	3
How It Works	4
Ratings	8
MicroComputer Control Center	9
Mechanical Specifications	11
Optional Features	14
Application Data	15
Dimensions	24
Electrical Data	26
Nozzle Arrangements: 12SC - 14SC	28
Nozzle Arrangements: 15SL and Larger	29
Guide Specifications	30

NOMENCLATURE

The model number denotes the following characteristics of the unit:

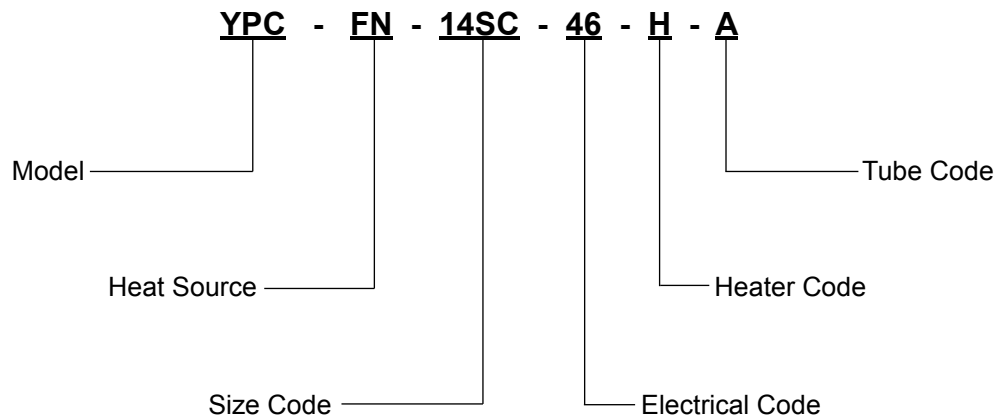

YPC ParaFlow Two-Stage Direct-Fired Absorption Chiller-Heaters Style A

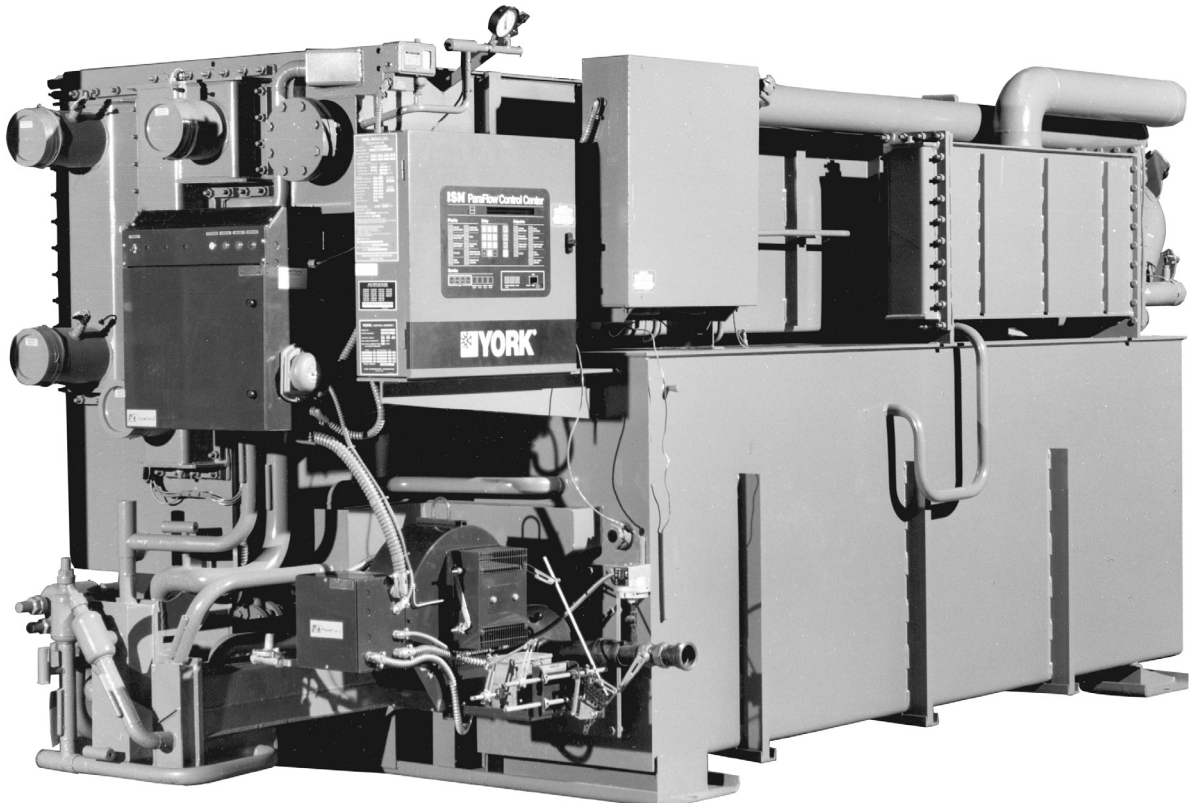

The YORK ParaFlow YPC Direct-Fired Absorption Chiller offers an environmentally-friendly alternative to electric energy. Since a YPC Direct-Fired Chiller uses inexpensive natural gas rather than electricity, owners can balance their energy needs and take advantage of the competition in an open energy market. And, because the unit also provides hot water for heating, typical applications will not require a boiler – saving even more money. With today's energy and environmental considerations, the YPC Direct-Fired Absorption Chiller is the ideal choice for a wide range of applications.

YPC Direct-Fired Chillers come equipped with the same sophisticated microprocessor controls found throughout Johnson Controls' product lines, making the YPC Direct-Fired Chiller the smartest absorber on today's market.

With its high efficiency, "Smart Controls," proven reliability and the guaranteed quality of a standard performance test, units are the ideal choice for today's demanding specifications.

CHILLING CYCLE

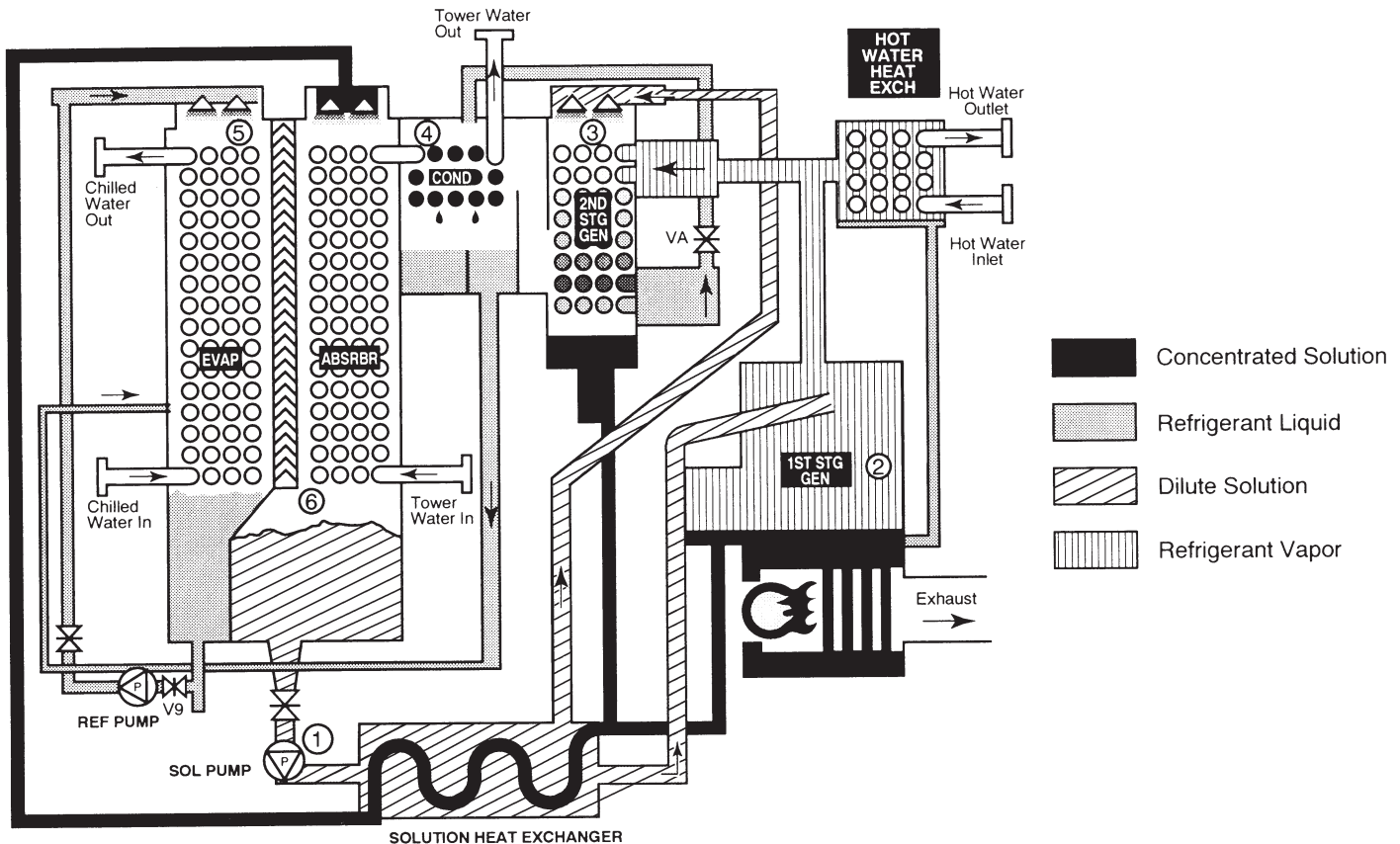

Note: There are two heat exchangers, but only one is shown for illustrative purposes.

CHILLING CYCLE

YPC's remarkably efficient two-stage absorption refrigeration cycle uses water as the refrigerant and lithium bromide (LiBr) as the absorbent. It is the strong affinity these two substances have for each other that makes the cycle work. The entire process occurs in hermetic vessels in an almost complete vacuum.

The large diagram above indicates the complete chilling cycle. The six steps are detailed here and on the next page, with corresponding numbers in the diagram to show where each step takes place. YPC's two-stage absorption chilling cycle is continuous; however, for the sake of clarity and simplicity, it is divided into six steps.

1. Solution Pump/Heat Exchangers

A dilute solution of LiBr and water descends from the Absorber to the Solution Pump. This flow of dilute solution is split into two streams and pumped through heat

exchangers to the First-Stage Generator and to the Second-Stage Generator.

YPC's exclusive two-way split of solution flow virtually eliminates the possibility of crystallization (solidification) by allowing the unit to operate at much lower solution concentration and temperatures than series flow systems.

2. First-Stage Generator

A heat source heats dilute LiBr coming from the Solution Pump/Heat Exchangers. This produces hot refrigerant vapor which is sent to the Second-Stage Generator, leaving a concentrated solution that is returned to the Heat Exchangers.

3. Second-Stage Generator

The energy source for the production of refrigerant vapor in the Second-Stage Generator is the hot refrigerant vapor produced by the First-Stage Generator.

This is the heart of Johnson Controls' remarkably efficient two-stage absorption effect. The refrigerant vapor produced in the First-Stage Generator is increased by 40% – at no additional expense of fuel. The result is much higher efficiency than in conventional systems.

This additional refrigerant vapor is produced when dilute solution from the Heat Exchanger is heated by refrigerant vapor from the First-Stage Generator. The additional concentrated solution that results is returned to the Heat Exchanger. The refrigerant vapor from the First-Stage Generator condenses into liquid giving up its heat, and continues to the Condenser.

4. Condenser

Refrigerant from two sources – (1) liquid resulting from the condensing of vapor produced in the First-Stage Generator and (2) vapor produced by the Second-Stage Generator – enters the Condenser. As the liquid refrigerant enters the low pressure of the condenser it flashes to vapor. The two sources of refrigerant vapor combine and condense to liquid as they are cooled by the condenser water. The liquid then flows down to the Evaporator.

5. Evaporator

Refrigerant liquid from the Condenser passes through a metering valve and flows down to the Refrigerant Pump, where it is pumped up to the top of the Evaporator. Here the liquid is sprayed out as a fine mist over the Evaporator

tubes. Due to the extreme vacuum (6 mm Hg) in the Evaporator, some of the refrigerant liquid vaporizes, creating the refrigerant effect. (This vacuum is created by hygroscopic action – the strong affinity **LiBr** has for water – in the Absorber directly below.)

The refrigerant effect cools the returning system chilled water in the Evaporator tubes. The refrigerant liquid/vapor picks up the heat of the returning chilled water, cooling it from 54°F to 44°F (12.2°C to 6.6°C). The chilled water is then supplied back to the system.

6. Absorber

As the refrigerant liquid/vapor descends to the Absorber from the Evaporator, a concentrated solution coming from the Heat Exchanger is sprayed out into the flow of descending refrigerant. The hygroscopic action between **LiBr** and water-and the related changes in concentration and temperature-result in the creation of an extreme vacuum in the Evaporator directly above. The dissolving of the **LiBr** in water gives off heat, which is removed by condenser water entering from the cooling tower at 85°F (29.4°C) and leaving for the Condenser at 92°F (33.3°C). The resultant dilute **LiBr** solution collects in the bottom of the Absorber, where it flows down to the Solution Pump.

The chilling cycle is now completed and begins again at Step 1.

HEATING CYCLE WITHOUT HOT WATER HEAT EXCHANGER

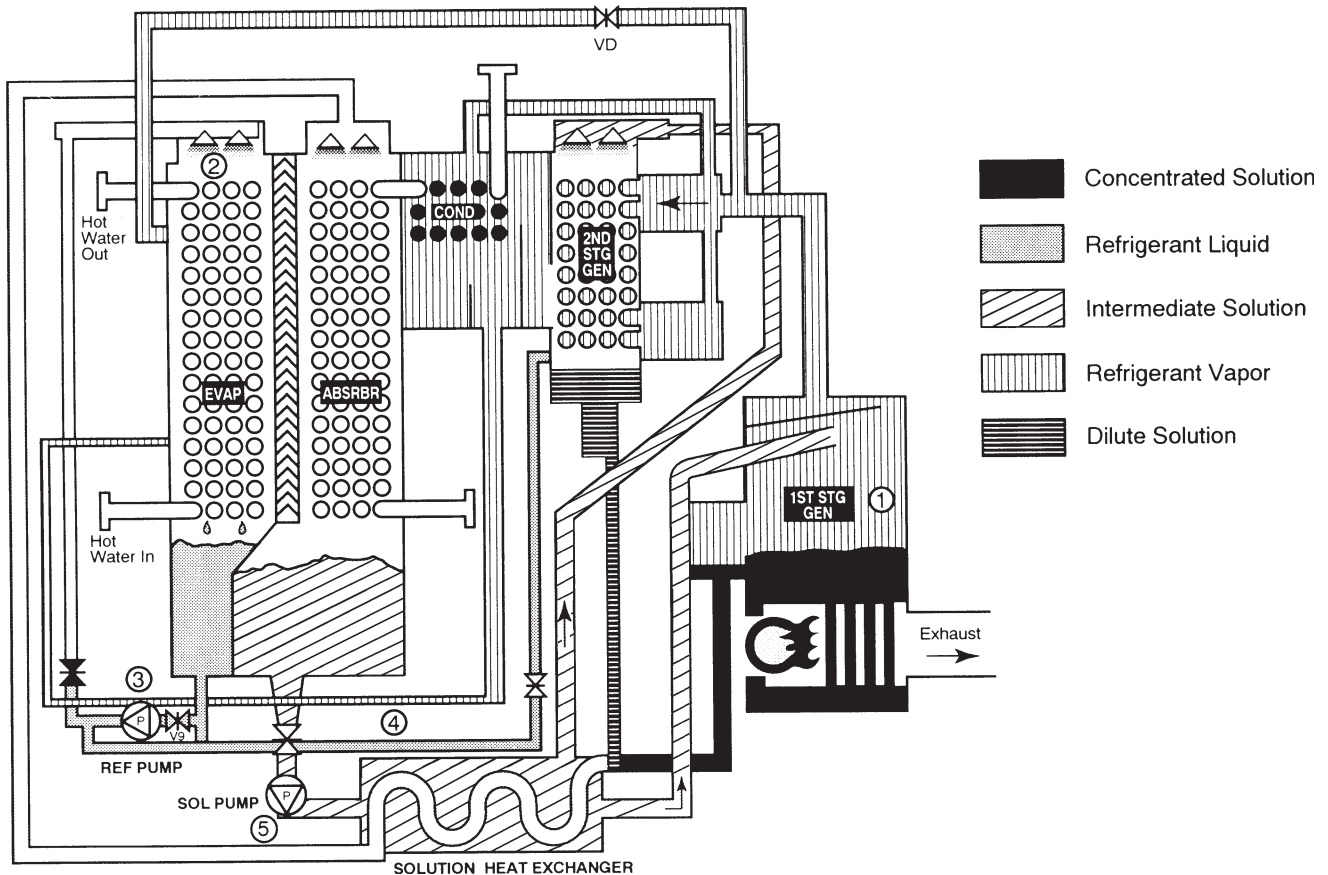

HEATING CYCLE WITHOUT HOT WATER HEAT EXCHANGER

1. First-Stage Generator

An energy source heats dilute **LiBr** solution in the First-Stage generator. This produces hot refrigerant vapor which travels through the open valve VD and also moves through the Second-Stage generator and Condenser to the evaporator.

2. Evaporator

The hot refrigerant vapor travels through the evaporator where it gives up heat to the system hot water, and changes state from vapor to liquid as its heat is removed. The refrigerant liquid collects in the bottom of the evaporator.

3. Refrigerant Pump

The refrigerant pump removes the refrigerant liquid from the evaporator and pumps it into the second stage generator where it mixes with intermediate **LiBr** solution to form dilute **LiBr** solution.

4. Heat Exchangers/Absorber

The dilute **LiBr** flows to the solution heat exchanger where it combines with the concentrated solution from the First Stage generator to form intermediate solution. The intermediate solution then flows through the absorber.

5. Solution Pump/Heat Exchangers

The solution pump moves the intermediate solution from the absorber through the solution heat exchangers and into the first and second stage generators and the process begins again.

HEATING CYCLE WITH OPTIONAL HOT WATER HEAT EXCHANGER

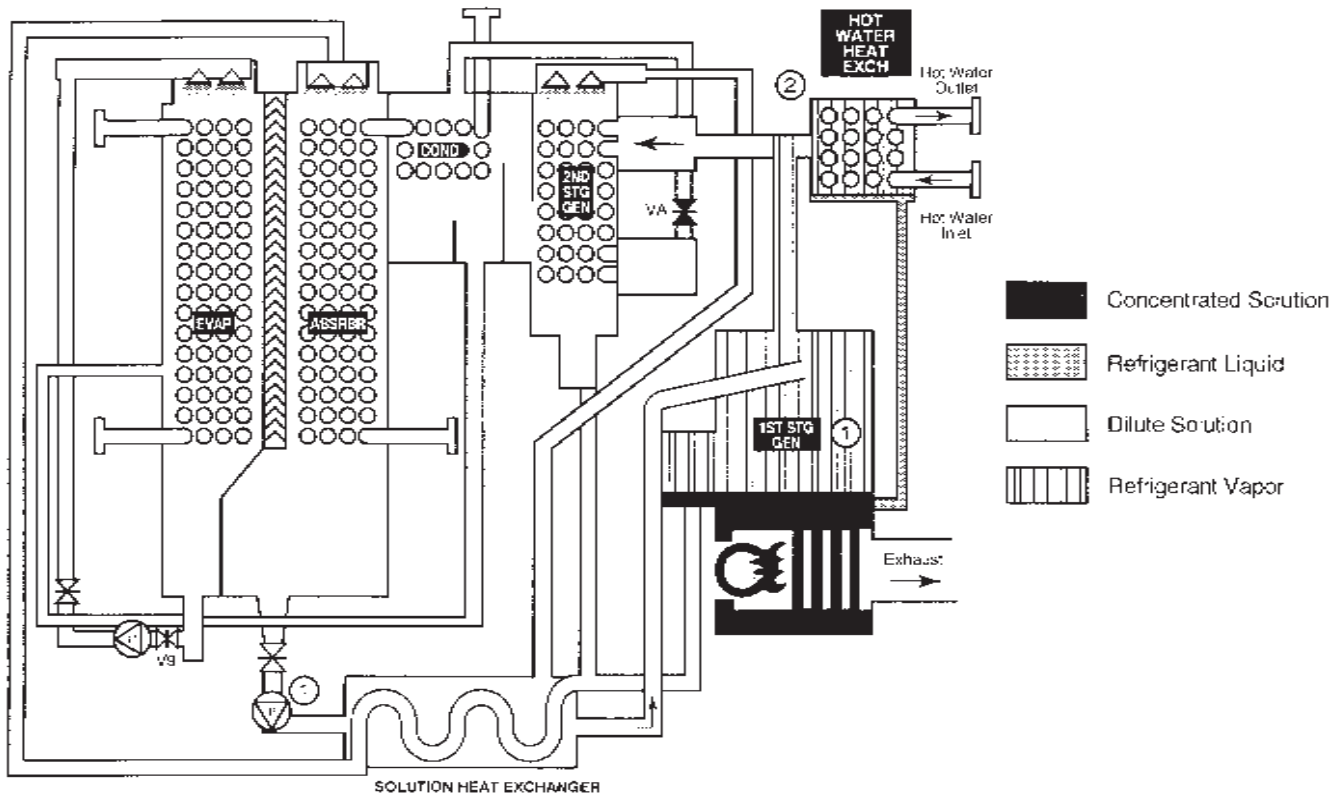

HEATING CYCLE WITH OPTIONAL HOT WATER HEAT EXCHANGER

1. First-Stage Generator

Dilute LiBr solution is heated by the energy source in the First-Stage Generator. This drives off refrigerant vapor and leaves concentrated solution.

2. Hot Water Heat Exchanger

The hot refrigerant vapor from the first stage generator gives up its heat to the System Hot Water Heat Exchanger and condenses to liquid as the heat is removed. The condensed refrigerant liquid returns to the First-Stage Generator and the cycle begins again.

COMPUTERIZED PERFORMANCE RATINGS

Each chiller selection is custom-matched to meet the individual application requirements. It is not practical to provide tabulated information for all possible combinations. Computerized performance ratings are available through each Johnson Controls Sales Office.

Fig. 1 details the high efficiency part load performance of the **YPC** Absorption Chiller. At both constant tower water temperatures and AHRI adjusted entering tower temperatures, the unique ParaFlow design delivers superior economy at low loads.

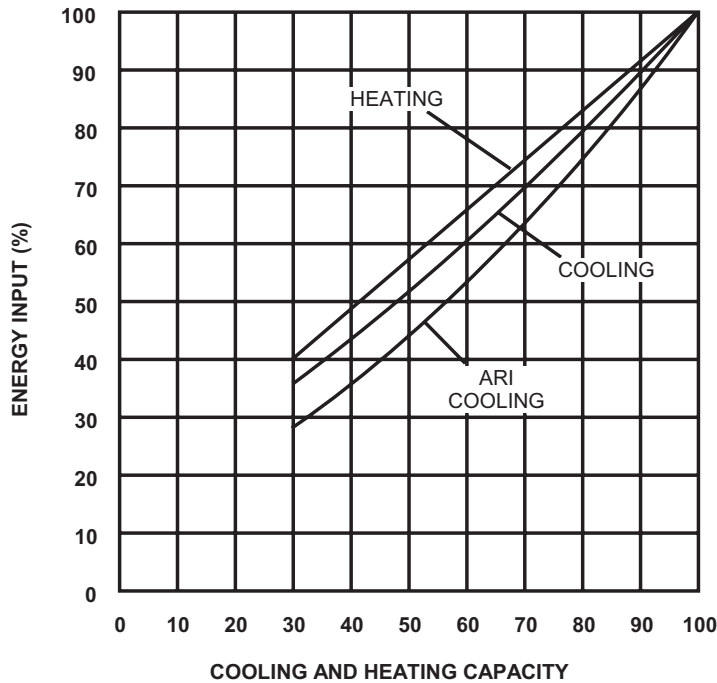

FIG. 1 – ENERGY INPUT VS. OUTPUT*

* Shows the part load performance of the YORK ParaFlow **YPC** chiller-heater. The highest efficiency is achieved between 50 and 100 percent chilling capacity. Valid for leaving chilled water temperature 42°- 52°F (6.6°C - 12.2°C).

TABLE 1 – IPLV ANALYSIS**

LOAD (%)	ENTERING COND. WATER TEMP.		COP	WEIGHTING FACTOR (FROM ARI 560-92)	WEIGHTED AVERAGE COP
	°F	°C			
100	85.0	29.4	1.00	0.17	0.17
75	77.5	25.3	1.10	0.39	0.43
50	70.0	21.0	1.17	0.33	0.39
25	70.0	21.0	1.09	0.11	0.12

** IPLV or NPLV = 1/ ((0.01/A)+(0.42/B)+(0.45/C)+(0.12/D))

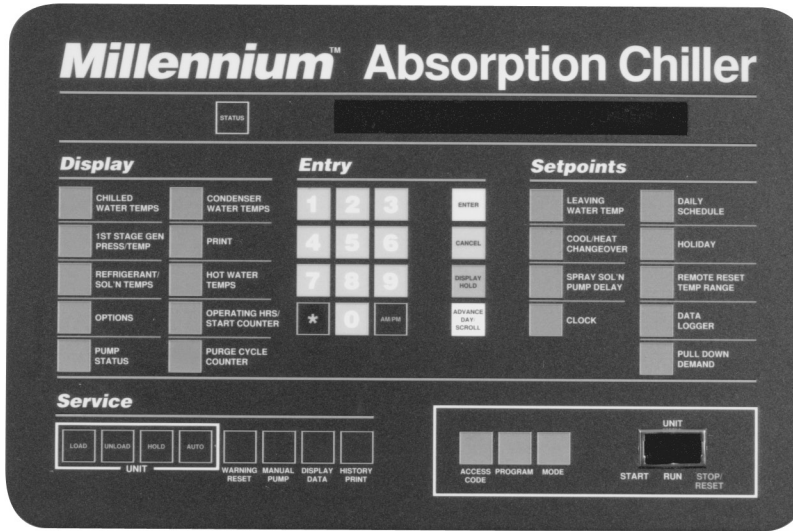

The YORK ParaFlow MicroComputer Control Center is designed for the very best in chiller protection and overall system efficiency. As standard equipment on all ParaFlow chillers, the ParaFlow MicroComputer Control Center is a major development in absorption chiller technology, providing the most precise and reliable control available in the industry.

INFORMATION DISPLAY

Vital chiller operating information can be shown on the 40 character alphanumeric display. All information is in the English language with numeric data provided in English or metric units. Information provided standard on all units includes:

- Chilled water temperatures, entering and leaving
- Hot water temperatures, entering and leaving
- Tower water temperatures, entering and leaving
- First-stage generator pressure and temperature
- Refrigerant temperature
- Solution temperature
- Operating hours
- Number of starts
- Number of purge cycles (last 7 days and lifetime total)
- Burner firing rate command (in %)
- Indication of each pump's operation

The operating program is stored in non-volatile memory (EPROM) to eliminate chiller failure due to AC power failure/battery discharge. In addition, programmed setpoints are retained in lithium battery-backed RTC memory for a minimum of 5 years.

In addition, all operating and setpoint information can be transmitted to an optional remote printer through the RS-232 port to obtain data logs:

- At any time by pressing the PRINT button

- At set time intervals by programming the panel
- After a safety shutdown to list the cause of the shutdown and the operational parameters just prior to shutdown
- For a complete history print-out of the last four shutdowns and operational parameters just prior to shutdown

CAPACITY CONTROL

When automatic capacity control is desired, the Micro-Computer Control Center automatically varies the burner firing rate to maintain the programmed leaving chilled water or hot water setpoint for cooling or heating loads ranging from 30% to 100% of design. Features include:

- Digital keypad entry of setpoint to 0.1°F (0.1°C)
- Verify actual vs. setpoint temperature via alphanumeric display.
- Remote reset of setpoint (up to 20°F (11.1°C) range) with a 1 to 11 second PWM signal (optional 4-20 mA, 0-10VDC or contact closure).

When automatic control is not desired, the input burner firing rate is also manually adjustable from the ParaFlow MicroComputer Control Center panel to any setting between minimum and maximum, provided heat input is not limited due to a specific operating condition (e.g. safety).

SYSTEM CYCLING CONTROLS

- Programmable seven-day time clock for automatic start/stop of chiller and chilled, condenser and hot water pumps.
- Separate schedule input strictly for holidays
- Remote cycling contacts available for other field supplied signals
- Multi-unit cycling contact input terminals for field supplied signals

WARNING CONDITIONS/INHIBITED UNIT LOADING

The ParaFlow MicroComputer Control Center provides a warning display message and, when beneficial to the machine, will limit heat input to 30% or 60% when operating conditions indicate the unit is moving towards a safety shutdown. This gives the operator the opportunity to fix a problem before it leads to a complete safety shutdown. Warnings include the following:

- Low refrigerant temperature
- High generator pressure or temperature
- High or low entering condenser water temperature
- Purge pump current overload
- Faulty solution dilution temperature sensor

SHUTDOWN CONTROLS

The following conditions will lead to unit shutdown. After a shutdown, the reason for the shutdown is displayed in English on the alphanumeric display. Each annunciation details the day, time, reason for shutdown and the type of restart required.

Cycling – those controls which automatically reset and permit auto restart of the system.

- Loss of condenser water flow
- Low leaving chilled water temperature
- Power failure (when automatic restart is selected)

Safety – those controls which (when employed) require a manual operation to restart the system.

- Solution pump thermal or current overload
- Refrigerant pump thermal or current overload
- Low refrigerant temperature
- First stage generator high temperature or pressure
- First stage generator low solution level
- Burner alarm indication
- Burner Panel malfunction (combustion-related malfunction)
- Loss of chilled water flow
- Power failure (when automatic restart not used)
- Incomplete dilution cycle due to any of the following:
 - Power failure
 - Solution/refrigerant pump overloads
 - Low refrigerant temperature
 - Loss of chilled water flow
- Auxiliary safety shutdown terminals for field supplied signals

CONCENTRATION CALCULATOR

The micropanel monitors the first-stage generator concentration to prevent operation at an unsafe concentration. Concentration is tied into both the Warning Conditions and

Safety Shutdown systems discussed in this section. Also included is an operator interface concentration calculator. When in the Program mode, an operator can use the concentration calculator to determine concentration by inputting set of conditions. The operator must input any two of three parameters (bromide solution temperature, saturation temperature, and pressure) and the micropanel will display the concentration. The display will also indicate if the input conditions are in the crystallization zone.

CONTROL MODE SELECTION

The ParaFlow MicroComputer Control Center includes secure programming and servicing capabilities. There are three keys for the selection of the control center modes:

- **ACCESS CODE** permits access to the control center **PROGRAM** button when the proper password is given
- **PROGRAM** permits operator to program the setpoints and select desired **MODE**:
- **LOCAL** allows manual unit start and purging.
- **REMOTE** allows remote start and stop of the unit remote reset of the chilled water temperature limit, while still allowing manual purging at the chiller.
- **SERVICE** allows manual operation of the burner firing rate, including **LOAD**, **UNLOAD**, **HOLD**, and **AUTO** keys. Manual operation of all pumps is also included.

BAS REMOTE CONTROL

A communication interface permitting complete exchange of chiller data with any BAS System is available with an optional Metasys™ translator. The Metasys™ translator also allows BAS System to issue commands to the chiller to control its operation. Metasys™ translators come in two models, controlling up to 4 chillers and 8 chillers respectively.

The ParaFlow MicroComputer Control Center also provides a direct hard wire interface capability with other building automation systems using a 1-11 PWM standard signal (4-20 mA, 0-10VDC or contact closure optional) including the following:

- Remote unit start/stop
- Remote chilled water temperature reset
- Remote hot water temperature reset
- Remote read out of status including:
 - Unit ready to start
 - Unit operating
 - Unit safety shutdown
 - Unit cycling shutdown

Mechanical Specifications

GENERAL

The YORK ParaFlow **YPC** Direct-Fired Absorption Liquid Chiller-Heater is completely factory-packaged, including a first-stage (high temperature) generator, burner, burner panel, solution heat exchangers, main shell, hot water heater, microprocessor controls and all interconnecting unit piping and wiring.

All models are shipped as a single piece complete with a factory balanced LiBr and refrigerant charge inside of the unit to simplify and expedite start up. The unit is also shipped with a nitrogen charge to eliminate the possibility of air entering the machine during shipment. Burner and Burner panel on each unit are factory mounted, wired and tested and ship preinstalled as integral components of the Chiller-Heater.

The purchase price includes the services of a Johnson Controls factory-trained, field service representative to supervise the initial start-up of the machine.

SOLUTION FLOW

The solution flow is divided into two parallel paths, one leading to the first stage generator and one to the second stage generator. In this way, each stream is concentrated only once, allowing for a more safe and efficient operation. The balance of flow between the two streams is pre-set at the factory and fine-tuned at start up to ensure maximum efficiency for any given application.

MAIN SHELL

The main shell consists of four separate shell and tube heat exchangers – the absorber, evaporator, condenser and second stage (low temperature) generator – all housed in a single carbon steel shell divided into low pressure and intermediate pressure sections. The shell is fabricated from formed carbon steel plates with fusion welded seams. Carbon steel tube sheets, drilled and reamed to accommodate the tubes, are welded to the end of the shell. Intermediate tube supports are fabricated of carbon steel plates. Each tube is roller expanded into the tube sheets to provide a leak tight seal; each tube is individually replaceable. The solution side of the shell is designed for a working pressure of 60 mm Hg absolute. The portion of the shell opposite the burner houses the low pressure section of the machine which includes the evaporator and the absorber. Both the absorber and the evaporator are drip-type heat exchangers with 5/8" (16 mm) OD, .025" (0.6 mm) wall copper tubing for the 12SC-14SC, and 3/4" (19 mm) OD, 0.028" (0.7 mm) wall for the 15SL and larger. Tubes are externally enhanced where necessary to achieve desired capacity. The absorber and evaporator are separated by finned eliminator baffles designed to allow water in the vapor state to pass to the absorber.

The burner side of the shell contains the intermediate pressure section of the machine consisting of the condenser and second stage generator. The second stage generator is a drip-type heat exchanger with 5/8" (16 mm), .025" (0.635 mm) wall, copper tubing for the 12SC-14SC, and 3/4" (19 mm) OD, .028" (0.7 mm) wall for the 15SL and larger. Generator and condenser are separated by baffling which prevents liquid carryover to the condenser. Condenser tubing is 5/8" (16 mm), .025" (0.635 mm) wall copper tubing for the 12SC-14SC, and 3/4" (19 mm) OD, .028" (0.7 mm) wall for the 15SL and larger.

The removable compact water boxes are fabricated of steel. The design working pressure is 150 PSIG (1 MPa) and the boxes are tested at 225 PSIG (1.6 MPa). Integral steel water baffles are located and welded within the water box to provide the required pass arrangements. Stub-out water nozzle connections with ANSI/AWWA C-606 grooves are welded to the water boxes. These nozzles are suitable for ANSI/AWWA C-606 couplings, welding or flanges, and are capped for shipment. Plugged vent and drain connections and lifting lugs are provided on each water box.

FIRST STAGE GENERATOR

The first stage generator is a single flooded heat exchanger using vertical carbon steel boiler tubes. The shell side is fabricated from carbon steel plate with fusion welded seams, and is designed for a working pressure of 13.5 PSIA (93 kPa). The unit bursting disk is designed to fail at 12 PSIG (83 kPa). Carbon steel eliminator baffles prevent solution carryover over with the refrigerant vapor. The generator uses a series of bare and enhanced vertically-oriented, carbon-steel boiler tubes to enhance heat transfer. Hot combustion gases flow from the combustion chamber across the tubes to provide the necessary heat input.

The high temperature generator contains a solution float valve which controls the level of solution in the generator. This limits the amount of sensible heating at part load conditions, resulting in much better performance.

SOLUTION HEAT EXCHANGER

The solution heat exchanger is a shell and tube design with geometrically-enhanced 5/8" (16 mm) OD for the 12SC-14SC, and 0.578" (15 mm) OD for the 15SL and larger, 90/10 cupro-nickel tubing. The shell is formed from carbon steel plate with fusion welded seam. Tubes are roller expanded into carbon steel tube sheets.

BURNER

The burner is a forced draft, flame retention burner listed by Underwriters Laboratories (IRI, FM and other codes available as options) and capable of operating on natural gas, propane, or No. 2 oil (as specified by the customer).

Mechanical Specifications - continued

The burner is made of welded steel and the combustion-head incorporates a multi-blade stainless steel, flame retention diffuser. Minimum turndown ratio is 3 to 1.

Combustion air is supplied by an integrally-mounted blower assembly incorporating a direct-drive, 3-phase motor. The burner uses a full-modulation-type fuel/air control system.

The gas control train is prepped and prewired with suitable junction boxes and terminal strips to burner panel terminal connections. The gas train contains the following components: manual shutoff cock, main gas pressure regulator, low and high gas pressure switches, two (2) UL listed leak test cocks, burner manifold gas pressure gauge, two (2) main motorized gas valves (for gas inputs of 5.0 MMBTU/HR and lower), two (2) main motorized gas valves – one (1) with proof of closure interlock switch (for gas inputs above 5.0 MMBTU/HR), and one (1) normally open vent valve sized according to IRI requirements.

The oil control train (when specified) incorporates U.L. approved components supplied by the burner manufacturer to provide the specified fuel/air control operation. The system uses a single high pressure oil nozzle of the internal-bypass type. The nozzle oil train includes one (1) 300 lb. (2.1 MPa) gauge to read nozzle return oil pressures.

The high pressure nozzle supply oil pump is a two (2) gear type capable of producing 300 psig (2.1 MPa) discharge pressure and 15 inches (381 mm) Hg. vacuum. It is a separate unit mounted on its own support base with a direct drive motor. The oil pump unit comes complete with removable mesh-type oil strainer, 0-300 psig (2.1 MPa) oil nozzle pressure gauge, nozzle line, main and auxiliary solenoid safety shutoff oil valves and low oil pressure switch. The oil nozzle bypass line uses dual check valves.

The flame safeguard control includes fully automatic pre-purge and post-purge sequencing of the burner blower motor, interrupted ignition system, and fuel/air flow components with an ultraviolet sensor for flame detection.

PUMPS

Solution and refrigerant pumps are hermetically sealed, self-lubricating, totally enclosed, liquid cooled, factory-mounted, wired and tested. Motor windings are not exposed to LiBr or water. The suction and discharge connections for each pump are fully welded to the unit piping to minimize the opportunity for leaks. Suction and discharge connections are also equipped with factory installed isolation valves to permit quick and easy servicing of pumps. All **YPC** units include one or two solution pump(s) and a refrigerant pump. Pumps are designed to operate for a total of 55,000 hours between service inspections.

VALVES

All valves used for adjusting the solution are fully welded or brazed to prevent leakage of air into the unit. Valve actuators are covered with a seal cap to eliminate the possibility of air leakage through the stem. Additionally, all connections of valves to unit piping are fully welded.

SOLUTION AND REFRIGERANT

Each ParaFlow unit is charged with LiBr solution with ADVAGuard™ 750 corrosion inhibitor. The refrigerant is deionized water. A small amount of 2-ethyl hexanol is added as a heat and mass transfer enhancer.

PURGE SYSTEM

The purge system automatically and constantly removes noncondensable vapors generated in the absorption process through the use of an eductor. Noncondensables are then stored in a purge chamber until they can be removed through the use of a purge pump. The purge pump is an oil, rotary, two-stage vacuum pump with a 1/4 HP, 3-Phase, ODP motor.

The chiller control panel includes a SmartPurge system that will automatically sense the amount of non-condensibles in the purge chamber and empty the tank whenever necessary. The SmartPurge system eliminates the need for an operator to ever manually empty the purge chamber. In addition, the control panel monitors the frequency of purge cycles and alerts the chiller operator, through a unique control panel warning message, if the number of purges exceeds normal levels.

CAPACITY CONTROL

Capacity control is accomplished by modulating the burner's firing rate. The **YPC** Direct-Fired unit is capable of modulating capacity from 30% to 100%.

The two-stage chiller design incorporates a float valve that limits solution flow to the generator as the cooling load decreases. This maintains optimum solution level throughout the operating range. In addition, manual control valves are used by Johnson Controls technicians in the factory and/or at start-up to fine tune solution and refrigerant flows to match the jobsite needs at peak efficiency.

POWER PANEL

The power panel enclosure includes the following: single point wiring connection for the incoming power supply; non-fused disconnect switch; motor starters, complete with current and thermal-overload protection for solution pump(s), refrigerant pump, and purge pump (current overloads only); 115VAC 50/60 Hz control power transformer.

PARAFLOW MICROCOMPUTER CONTROL CENTER

The microprocessor based control center is factory-mounted, wired and tested. The electronic panel automatically controls the operation of the unit in meeting system cooling or heating requirements while minimizing energy usage. Chiller operating parameters are sensed by either thermistors or transducers and displayed on the keypad. All pressures are taken as absolute to alleviate typical gauge pressure inaccuracies. Temperatures and pressures can be displayed in English (F, PSIA) or metric (C, KPa) units depending on the application. Display of all information is shown in the English language on a 40-character alphanumeric display.

Available operating information includes return/leaving chilled water temperatures, return/leaving tower water temperatures, first stage generator pressure and temperature, refrigerant and solution temperatures, operating hours, burner firing rate and number of starts and purges.

Warning Conditions – The ParaFlow MicroComputer Control Center provides a warning annunciation and, when appropriate, limits heat input under the following conditions: low refrigerant temperature, high generator pressure or temperature, high or low entering condenser water temperature, purge pump current overload, faulty solution dilution temperature sensor.

Safety Controls – The control center includes unique safety logic designed to protect the **YPC** chiller from damaging malfunctions. Complete safety annunciation is displayed for each shut-down by pressing the status key. This information includes day, time and reason for shutdown. These include: solution- or refrigerant-pump thermal or current overload, low refrigerant temperature, first-stage generator high pressure or temperature, loss of chilled water flow, power failure, burner safety shutdown, auxiliary safety shutdown, incomplete dilution cycle and power failure if manual restart after power failure is selected.

Operating Controls – Background messages are displayed while the unit is running to signal operator of controlling conditions such as leaving chilled water temperature control and non-critical sensor error. System cycling messages display day, time, cause of cycling shutdown, and autostart indication. These include loss of condenser water (or hot water) flow, low-leaving chilled water (or high leaving hot water) temperature, and power failure (when autostart is selected).

Digital programming of operating setpoints from the keypad include leaving chilled water (or hot water) temperature, pulldown demand limiting, remote reset temperature range daily start/stop scheduling of chiller and water pumps with separate holiday schedule.

Security access code is provided for operator to program setpoints or to choose local, remote, or service modes of operation. Manual control of the burner firing rate and all pumps is provided through separate buttons in the service mode of operation.

Data Logging – All operating and setpoint information can be transmitted to a remote printer (by others) through the RS-232 port in the control center to obtain data logs. This can be accomplished at any time by pressing the “Print” button on the control center, or automatically at predetermined intervals by programming the panel’s data logger. The printer will automatically record time and cause of any safety or cycling shutdown along with all chiller operating data monitored by the panel just prior to shutdown. A “History Print” button also allows the printout of the last four causes of cycling or safety shutdowns plus operating data for each shutdown.

BAS Interface – The ParaFlow MicroComputer Control Center is compatible with remote Building Automation Systems (BAS). The standard design allows remote start and stop; leaving chilled-water temperature reset and steam demand limit through PWM signal; and “ready-to-start,” “unit running,” “safety” and “cycling” shutdown status contacts. For designed-in features and reliability, Johnson Controls provides a full line of BAS controls.

FACTORY LEAK TEST

Each ParaFlow unit is subjected to a series of four rigorous leak tests, culminating in a vacuum leak test measured by a mass spectrometer and conducted while the unit is immersed in an atmosphere of low-density helium.

Codes and Standards

- ANSI/AHRI 560-00 -Standard for Absorption Water Chiller and Water Heating Packages
- U.L. (other codes as an option for burner/gas train system)
- NEC - National Electrical Code
- OSHA – Occupational Safety and Health Act
Paint

Exterior surfaces are protected by an initial coat of red oxide primer with a single finish coat of Caribbean-blue, air-drying, high-solids, enamel machinery paint.

SHIPMENT

Protective covering is furnished on the microprocessor controls, burner and other electric devices. Water nozzles are capped prior to shipment.

Optional Features

SPECIAL TUBE MATERIALS AND WALL THICKNESSES

YPC units are designed for long life with the standard tube materials and wall thicknesses in each heat exchanger. For special applications where different tube specifications are required, Johnson Controls offers copper tubing with .028" (0.71 mm) (where .025" (0.635 mm) is standard) and .035" (0.89 mm) wall thicknesses. Also, 90/10 cupro-nickel tubes are available for the absorber, evaporator, and condenser in both the standard and the above-listed optional tube-wall thickness.

WATER FLANGES

150 lb. (68 kg) ANSI raised-faced flanges for the evaporator and/or absorber/condenser water connection are factory welded to water nozzles. Companion flanges, bolts, nuts and gaskets are not included.

WATER FLOW SWITCH

This is a paddle-type, vapor-proof water flow switch suitable for 150 PSIG (1.0 MPa) DWP (300 PSIG [2.1 MPa] available) for the absorber/condenser water circuit (chilled-water flow switch is standard).

SPARE PUMPS

A complete set of replacement solution and refrigerant pumps ships alongside the unit for local spare parts inventory.

REMOTE RESET CONTROLS

An optional board allows for continuous reset of leaving chilled-water temperature using a 4 to 20 mA, 0 to 10 VDC, or contact closure as opposed to the standard 1 to 11 second PWM signal. These signals may be wired directly to the panel terminal block on the card file without any external interfacing.

SHIP WITH SEPARATE CHARGE

All models ship with the LiBr and refrigerant charge in the unit. For applications which require light rigging loads, the charge can be removed and shipped alongside the unit for recharging in the field.

LOW NOX BURNER

For areas with restrictive clean air requirements, Johnson Controls offers a burner with low (<30 ppm) nitrous oxide emissions.

SPECIAL BURNER CODES

Many localities have their own code requirements for equipment with burners. When specified, Johnson Controls can provide a burner built to meet special code requirements.

175°F HOT WATER OPTION

This option includes an external heater which allows up to 175°F (79.4°C) leaving hot water temperature, and allows simultaneous heating and cooling (See Figs. 3 and 4).

MARINE WATER BOXES

Marine water boxes allow service access for cleaning of the heat exchanger tubes without the need to break the water piping. Bolted-on covers are arranged for convenient access. Victaulic nozzle connections are standard; flanges are optional. Marine water boxes are available for the evaporator or the absorber/condenser circuits. Marine water boxes are only available for circuits with 150 PSIG (1.0 MPa) working pressures.

HIGH PRESSURE WATER CIRCUITS

For applications with working pressures which exceed 150 PSIG (1.0 MPa), high pressure water boxes are available. These compact water boxes are rated for 300 PSIG (2.1 MPa) DWP and tested at 450 PSIG (3.1 MPa).

Application Data

The following discussion is a user guide in the application and installation of ParaFlow **YPC** Chiller-Heaters to ensure the reliable, trouble-free life for which this equipment was designed. While this guide is directed towards normal water-chilling applications, your local Johnson Controls sales representative can provide complete recommendations on other types of applications.

LOCATION

YPC units make very little noise or vibration and may generally be located at any level in a building where the construction will support the total system operating weight. The unit site should be a floor, mounting pad or foundation which is level and capable of supporting the operating weight of the chiller. The unit will operate properly and produce maximum output only if it is installed level within 1/1000 of unit length in the lengthwise direction and 1/1000 of unit width in the widthwise direction.

Leave between 46 and 60 inches (1.17 - 1.52 m) of space around the machine for servicing, reading instruments, and performing tests. If there are flammable materials near the machine, leave at least 20 inches (0.5 m) of space above the machine and at least 40 inches (1.02 m) above the first stage generator. Required tube pull space is equal to the unit length on either end of the machine, with 40 inches (1.02 m) on the opposite end.

Absorption chillers are not suitable for outdoor installation. The machine room must be enclosed and properly ventilated to keep its temperature no higher than 104°F (40°C), and no lower than 35°F (1.7°C).

WATER CIRCUITS

Flow rate – For normal water chilling duty, chilled and tower water flows are permitted at any velocity between 4.9 and 10 fps (1.5 and 3.05 m/s). **YPC** chillers are designed for constant flow systems. Applications involving chilled and condenser water flow rates which vary by more than +/- 10% from design will require special consideration. Contact your Johnson Controls representative for flow limits at specific design conditions.

Temperature ranges – For normal chilling duty, leaving chilled water temperatures may be selected between 42°F and 60°F (5.55°C and 15.5°C) for water temperature ranges between 8°F and 20°F (4.4°C and 11.1°C).

Water quality – The practical and economical application of liquid chillers requires that the quality of the water supply for the evaporator and the absorber/condenser be analyzed by a water-treatment specialist. Water quality may affect the performance of any chiller through corrosion, depositions of heat-resistant scale, sedimentation or organic growth. These will hurt chiller performance and

increase operating and maintenance costs. Normally, performance may be maintained by corrective water treatment and periodic cleaning of tubes. If water conditions exist which cannot be corrected by proper water treatment, it may be necessary to provide a larger allowance for fouling, and/or specify special materials of construction.

General water piping – All chilled water and tower water piping should be designed and installed in accordance with accepted piping practice. Chilled water and tower water pumps should be located to discharge through the unit to assure positive pressure and flow through the unit. Piping should include offsets to provide flexibility and should be arranged to prevent drainage of water from the evaporator and condenser when the pumps are shut down. Piping should be adequately supported and braced independent of the chiller to avoid imposition of strain on chiller components. Hangers must allow for alignment of the pipe. Isolators in the piping and in the hangers are highly desirable in achieving sound and vibration control.

Convenience considerations – With a view to facilitating the performance of routine maintenance work, some or all of the following steps may be taken by the purchaser. Evaporator and condenser water boxes are equipped with plugged vent and drain connections. If desired, vent and drain valves may be installed with or without piping to an open drain. Pressure gauges with stop cocks, and stop valves, may be installed in the inlets and outlets of the tower and chilled water lines as close as possible to the chiller. An overhead monorail crane or beam may be used to facilitate servicing.

Connections – The standard unit is designed for 150 PSIG (1.0 MPa) design working pressure in both the chilled and tower water circuits. The connections (water nozzles) to these circuits are furnished with grooves for Victaulic couplings (ANSI flanges are optional). Piping should be arranged for ease of disassembly at the unit for performance of such routine maintenance as tube cleaning. A crossover pipe to route the tower water from the absorber into the condenser is integral to the machine construction for the 12SC-14SC. Models 15SL and larger require an external crossover pipe from absorber to condenser. External crossovers are provided by Johnson Controls and will ship mounted on the chiller. All water piping should be thoroughly cleaned of all dirt and debris before final connections are made to the machine.

Pump on/off control - Contacts are provided in the ParaFlow MicroComputer Control Center to start/stop chilled and tower water pumps. The contacts can be used to supply 115V power to a pump motor starter relay, or as dry contacts to signal a building automation system to start/stop flow through the chiller. Johnson Controls

Application Data - continued

recommends that these contacts be used for all installations whether they directly control the pumps or they are used as inputs that tell the building automation system when to supply flow. Absorption chillers require flow at shutdown to perform a dilution cycle that will vary in length depending on operating conditions at shutdown. Without flow, the dilution cycle will terminate early, which can lead to crystallization.

Chilled water – The chilled water circuit should be designed for constant flow. A flow switch, provided standard with the unit, must be installed in the chilled water line of every unit. The switch must be located in the horizontal piping close to the unit, where the straight horizontal runs on each side of the flow switch are at least five pipe diameters in length. The switch must be electrically connected to the chilled water interlock position in the unit control center. A water strainer, of maximum 1/8" mesh should be field-installed in the chilled water inlet line as close as possible to the chiller. If located close enough to the chiller, the chilled water pump may be protected by the same strainer. The flow switch and strainer assure chilled water flow during unit operation. The loss or severe reduction of water flow could seriously impair performance or even result in tube freezeup.

Condenser water – Like the chilled water circuit, the tower water circuit requires a means of proving flow. The recommended method of proving flow is a tower water flow switch (not in standard supply scope, but available from Johnson Controls) installed in the tower water piping in the same manner as the chilled-water flow switch (above).

The **YPC** Chiller is engineered for maximum efficiency at both design and part load operation by taking advantage of the colder cooling tower water temperatures which naturally occur in the winter months. In its standard configuration, **YPC** absorbers can tolerate entering tower water temperatures as low as 68°F (20°C). Because the unit flow rates must be maintained, the recommended method of tower water temperature control is a three-way mixing valve.

At the initial startup, entering tower water temperature may be as low as 59°F (15°C), provided the water temperature rises to 68°F (20°C) within twenty minutes.

ON/OFF CYCLING

Once the chiller reaches its minimum operating load, if the cooling load decreases, the leaving chilled water temperature will fall below the setpoint. When the leaving chilled water temperature falls 3°F below the setpoint, the chiller will cycle off. During a cycling shutdown, the

Control Center continues to monitor the leaving chilled water temperature; when the temperature rises 1°F above the setpoint, the chiller will cycle on. The on/off cycling band used causes no noticeable effect for most cooling applications. To prevent wear damage associated with starting and stopping, it is recommended that installations be designed to prevent the two-stage absorption chiller from cycling more than twice per hour.

RUPTURE DISK PIPING

All **YPC** Chillers ship with a rupture disk(s) designed to fail at 12 PSIG (0.83 bar). The purpose of the rupture disk is to quickly relieve excess pressure as a precaution in the event of an emergency such as a fire. Refer to factory submittal for rupture disk size.

A CPVC or fiberglass discharge pipe should run from the rupture disk to a drain. Steel rupture disk piping is not recommended unless extra care is taken to support the piping and isolate any stress from the rupture disk. The discharge piping must supported independent of the unit.

SOUND AND VIBRATION CONSIDERATIONS

Since the unit generates very little vibration, vibration eliminating mounts are not usually required. However, when the machine is installed where even mild noise is a problem, mounts or pads can be used. The use of anchoring bolts on the machine legs is not normally necessary.

THERMAL INSULATION

YPC units require thermal insulation (by others) on both hot and cold surfaces in order to achieve maximum efficiency and prevent sweating. Required insulation area is tabulated on p. 25.

SIMULTANEOUS OPERATION

YPC Chiller-Heaters equipped with an optional hotwater heat exchanger can provide both chilled water and hot water simultaneously. An understanding of the simultaneous operation feature and its limitations is required to ensure proper application. Simultaneous operation can take place only if there is a basic demand for chilled water and when an optional high temperature heater is provided. The chillers operation of the machine during simultaneous operation is initiated and controlled by the chilling load, and it is essentially the same as the normal chilling operation. The only difference is that during simultaneous operation some of the vapor generated in the first-stage generator is utilized to make hot water. To control the hot water temperature, a motorized mixing valve and two temperature controllers must be supplied and installed in the hot water circuit by the installer as shown in the sketch in Fig. 4. One controller senses the

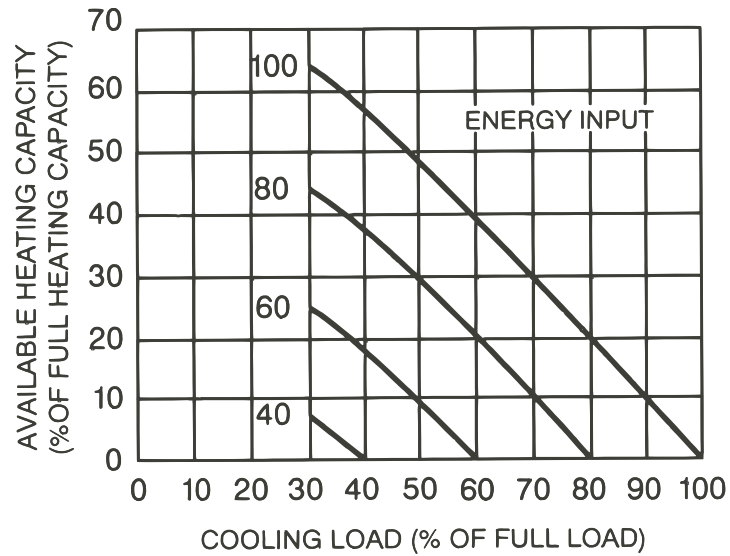

FIG. 3 – SIMULTANEOUS OPERATION

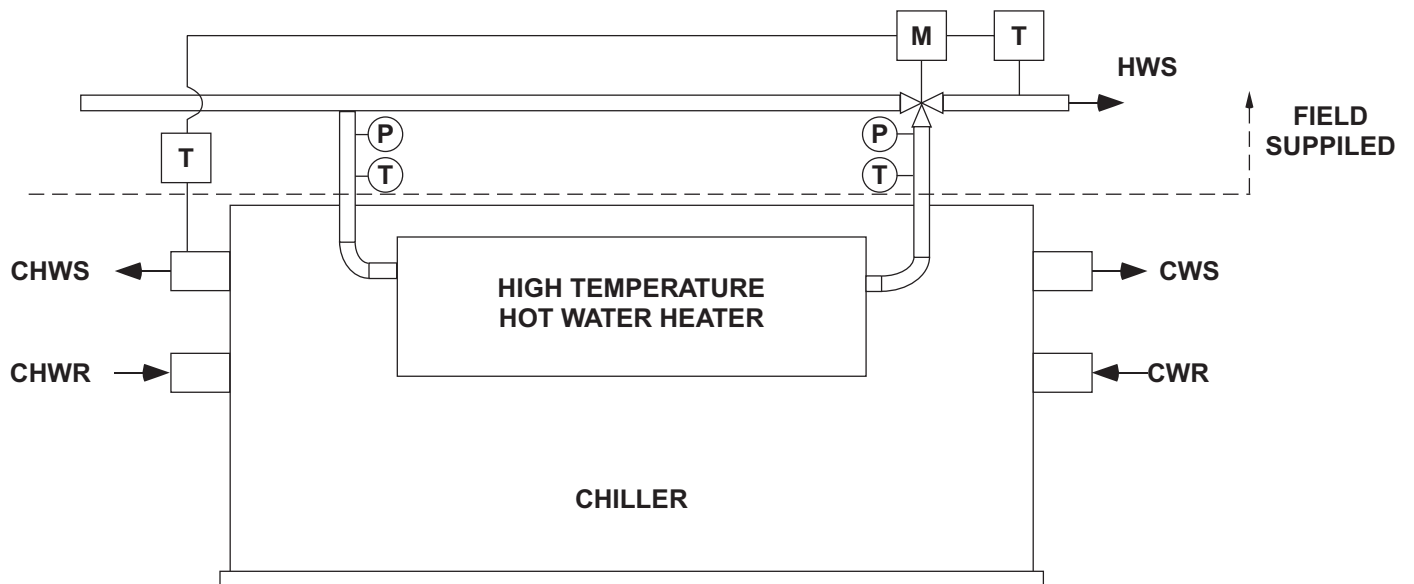

FIG. 4 – SUGGESTED PIPING SCHEMATIC FOR SIMULTANEOUS OPERATION
(All piping and Controls by Others)



* Hot water connections same as chilled water

FIG. 5 – HEATING MODE – STANDARD HEATER (TWO PIPE SYSTEM)

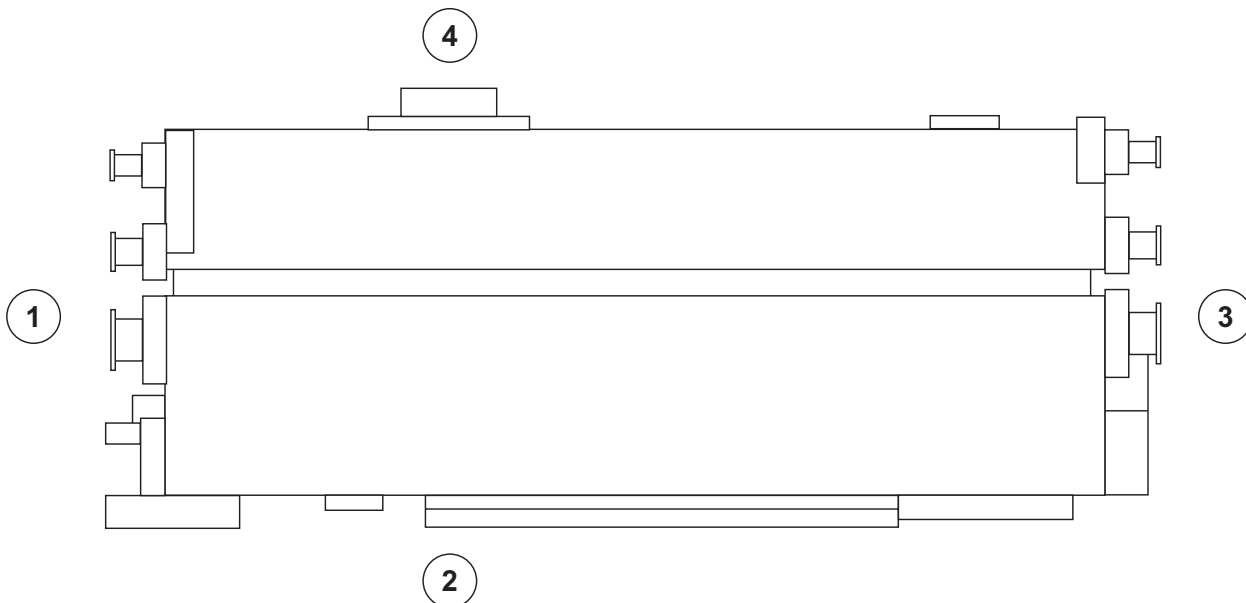

FIG. 6 – TYPICAL NOISE LEVELS

NOISE LEVEL *

Location 1	82 dB(A)
Location 2	81 dB(A)
Location 3	83 dB(A)
Location 4	83 dB(A)

* Measured 1 meter from the machine

leaving hot water temperature and positions the mixing valve to maintain that temperature. The other controller acts as a limit switch and will abort simultaneous operation by placing the mixing valve in the full by-pass position and stopping the hot-water circulating pump if the leaving chilled-water temperature rises to a pre-set level (usually 50°F (10°C)), indicating that too much energy is being used to make hot water and the chiller cannot meet the chilling demand.

Since the machine operation is controlled by the chilling load, the amount of available heating capacity as well as the hot water temperature will vary as the chilling load varies. The graph in Fig. 3 shows the relationship between chilling capacity and heating capacity at varying energy input rates.

For example, at 100% energy input rate (top curve), the machine will produce 100% chilling and no heating or, 80% chilling and 20% heating, or 50% chilling and 48% heating, etc. At 80% energy input rate, the machine will produce 80% of the rated chilling capacity and no heating, or 50% chilling and approximately 28% heating, etc. When the YPC Chiller/Heater is in the heating only (not simultaneous) mode, the mixing valve must be in the open position to allow full flow through the hot water heat exchanger. The hot water controller will then modulate the burner to meet load variations and the machine will operate in the normal manner.

A standard heater is designed for a two pipe system, thus simultaneous is not possible. Heating is accomplished in the evaporator (See Fig. 5).

AIR SUPPLY AND CHIMNEY SYSTEM

Air Supply – As with any natural gas or No. 2 Oil-fired appliance, adequate combustion air supply must be provided for proper and complete combustion. As a general rule, 12 standard cubic feet (0.34 standard cubic meters) of air are required for every 1000 Btu (1054 kJ) of fuel burned, assuming combustion with 20% excess air.

In addition to direct combustion air, outside air is also needed for ventilation and as make up to any machine room air which is induced up the chimney through a barometric draft regulator.

Air supply openings of adequate size must be provided to the machine room in accordance with local codes and standards. The specific location and size should be sufficient to allow an unobstructed flow of fresh air to the burner. Under no circumstances should the static pressure in the mechanical room become negative (below atmospheric pressure).

Contacts are provided in the burner panel (supplied

mounted on the YORK chiller-heater) to tie in the opening and closing of fresh air dampers into the start/stop sequence of the chiller. If the fresh air dampers do not open within 60 seconds, the ParaFlow MicroComputer Control Center will shut the chiller down, preventing an unsafe operating condition.

Chimney Draft Theory – Draft control serves two important functions for **YPC** Direct Fired chiller-heaters: 1. It removes the combustion products from the living or work space, and 2. Minimizes excess draft which pulls useful heat out of the unit and lowers its efficiency.

Draft depends on two important factors: 1. The temperature difference between the flue gas and the outside air, and 2. The height of the chimney. Higher temperature differences between the flue gas and the outside air, and higher chimneys both create more draft.

Chimney draft is the force created by the difference in temperature between the flue gases and the outside ambient air. The magnitude of this temperature difference is directly proportional to the draft created. Temperature difference causes draft because gases, such as air, occupy different volumes at different temperatures. For example: One cubic foot of air weighs 0.0834 pounds (37.8 grams) at a temperature of 0°F. This same cubic foot of air at 450°F (232°C) weighs only 0.0422 lbs. (19.1 grams). The amount of mass per specific volume is referred to as density. Density decreases as temperature increases and lighter (lower density) air rises while heavier, more dense air sinks. This is the same phenomena that leads to air stratification in buildings. The temperature in a room at the thermostat may be 70°F (21.1°C) but the temperature near the ceiling may be 80°F (26.7°C).

Heated combustion gases being less dense than the cooler outside air rise and flow out of the top of the chimney and create a partial vacuum. This causes a negative pressure at the chimney inlet that pulls in more gas for venting. This pulling force is referred to as chimney draft.

Because the direct-fired chiller-heaters are capable of operating in both the heating and cooling modes, the outdoor air temperatures will change significantly from the summer (cooling season) to the winter (heating season). These wide temperature swings must be accounted for during system design. The larger the temperature difference the greater the draft. Therefore, when the unit is operating during the colder months more draft will be produced. It is essential that the chimney system be designed using summer ambient conditions so as to avoid undersizing the draft system.

Chimney Design Theory – The following is a discussion of the basic terms and approach used in chimney

design. It is not the intent of this section to address the fine details of proper chimney design. Because of the large number of variables, this must be addressed on an application specific basis by an experienced designer knowledgeable in chimney systems, draft control, and local code requirements.

Theoretical Draft (Dt) – The definition of Theoretical Draft is the natural draft or “Chimney Effect” produced by difference in densities of hot exhaust gas relative to cooler ambient air.

Available Draft (Da) – The Available Draft is the draft required at the outlet exhaust flange of the YORK High Temperature Generator.

Pressure Drop (dP) – Frictional losses in the chimney system which act against theoretical draft. The chimney draft needed to overcome chimney frictional losses is described as follows:

$$Dt = dP + Da$$

Proper chimney design balances the theoretical draft (Dt) against the pressure drop (dP) of the chimney system in order to provide the required available pressure (Da) at the outlet of the chiller-heater.

Proper chimney design must provide the required (Da) under all operating conditions. Because the difference between summer and winter ambient conditions can result in Dt variations of 50% and greater, some method of draft control is usually required in order to maintain Da.

Chimney Application – The YORK ParaFlow YPC direct-fired chillerheater is equipped with a forced draft burner capable of firing on a variety of fuels, including natural gas and/or No. 2 oil and/or propane. As such, the unit will require a properly designed chimney system to control draft and discharge flue gases from the unit to the atmosphere.

The combustion chamber of the chiller-heater is engineered to product a positive gauge pressure of 0.05 to 0.15 in. of water (1.27 - 3.81 kg/m²) at the outlet of the first stage generator with an exhaust temperature of 400°F +/- 50°F (204°C +/- 28°C). As such the chimney design must provide a method for maintaining the pressure at all ambient conditions. Because YORK chiller-heaters operate at “high fire” throughout the summer months, it is important to design the chimney system for summer ambient design conditions to avoid undersizing. It is recommended that the chimney itself should be designed for a Da of 0 (zero) in. (0 mm) of water column. This will prevent the chimney from becoming pressurized at any point along the flue gas path.

If the stack/chimney pressure is ever above 0 (zero) in. of water column there is a chance of flue gas being leaked into the equipment room.

There are two commonly used ways to maintain the pressure at the outlet of the chiller-heater. Either manual or automatic/motorized draft control can be used. All YORK direct-fired chiller-heaters will come standard with a manual draft control damper. This damper can be modified for motorized operation either in the factory (if ordered) or in the field if site conditions require.

Manual Draft Control – Manual draft control is suitable for applications where each gas fired appliance will have its own dedicated chimney and draft control system. Fig. 7 depicts a simple yet effective means of controlling draft. With this system, a (field supplied) barometric draft regulator is used in series with the factory supplied manual backdraft damper. With maximum economy employed in the chimney design, Dt would exactly equal dP + Da during the summer design ambient conditions with the barometric regulator closed. In reality, some degree of conservatism should exist in the design, causing the barometric regulator to be open slightly even during summer design conditions. As ambient temperatures drop, Dt would increase, if not for the barometric draft regulator. With the regulator in place, mechanical room air is introduced into the chimney system in response to the impressed draft, thus stabilizing the gauge pressure just upstream of the barometric regulator. Most barometric regulators can maintain -0.06 in. water column gauge pressure when properly sized for a particular application.

With the gauge pressure stabilized upstream of the barometric regulator, the factory supplied manual backdraft damper can be adjusted to a fixed position which will provide the pressure drop to yield the required positive pressure at the exhaust flange of the chiller-heater.

Motorized Draft Control – Motorized draft control is suitable for applications where multiple gas fired appliances will be ducted into one common chimney system. In this case each unit will require its own draft control system. (Motorized draft control may be used for one chiller-heater/one chimney applications as well if it is desired over manual control.) Fig. 8 depicts a sequential draft control system which incorporates a motorized damper whose position is automatically adjusted as a function of available draft at the outlet of the chiller. The Johnson Controls supplied backdraft damper at the outlet of the chiller can be modified (in the factory if ordered, or in the field) to mount the motor driver. The motor is controlled from a draft control panel which senses the pressure at the outlet of the chiller-heater. The draft control panel is available from Johnson Controls to ship with the chiller. The panel is wired to the burner panel and damper motor

in the field, and the pressure is sensed through a small line field connected to the outlet of the chiller-heater.

Special Problems and Maintenance – Factors causing draft variations during normal operation include: wind and weather factors, inadequate chimney construction or system installation, location of installation, or inadequate system maintenance.

Wind and weather – Windy conditions will tend to increase the draft in the chimney as the wind helps to remove the combustion products leaving the chimney at a much faster rate. Down draft may occur causing a temporary positive pressure in the chimney system. The stack should be designed to prevent not only wind, but rain and snow from entering the stack. A flue cap should be installed.

Inadequate System Installation – If the diameters of the chimney system are too restrictive, the combustion products and flue gases may not be allowed to leave the system. On the other hand if the flue passages are too large, the chimney is never given a chance to completely warm due to the large surface area of the flue. This situation may cause poor draft and flue gas condensation which can corrode the chimney. To allow the chimney system to heat up faster, insulation should be installed on all exposed flue piping. Insulation is also a good safety measure (often required by code) as the breaching and flue pipes will heat to temperatures in excess of 400°F (204°C).

Location of installation – Consideration should be given to the location of the stack in comparison to building intake

and exhaust vents, cooling towers, etc. The effect of wind patterns around a building can create surface pressures and eddy currents that could lead to draft problems or contamination of other systems.

Inadequate System Maintenance – Inadequate system maintenance may lead to burner sooting. If left unattended for long periods of time, the flue passages can become restricted reducing the draft. Flue gas should be sampled on a regular basis to check for proper fuel/air ratios.

For More Information – For information regarding chimney and breaching design procedures, refer to ASHRAE 1992 Systems and Equipment Handbook, Chapter 31 and the National Fuel gas code (NFPA 54 1992). For information regarding the effects of airflow around buildings refer to ASHRAE 1993 Fundamentals Handbook chapter 14. Also, independent companies exist which design and supply stack materials. These companies have engineering programs to design chimneys for specific application considerations. When contacting such a company expect to need certain information including: Fuel type and consumption, design ambient temp. (it is best to design for the hottest summer day), flue gas temp., expected height of stack, number of expected fittings (elbows, T's, etc.).

ELECTRICAL DATA

Table 4 contains unit electrical data. Total kW includes power requirements for the system solution and refrigerant pumps. Each model has one solution and one refrigerant pump.

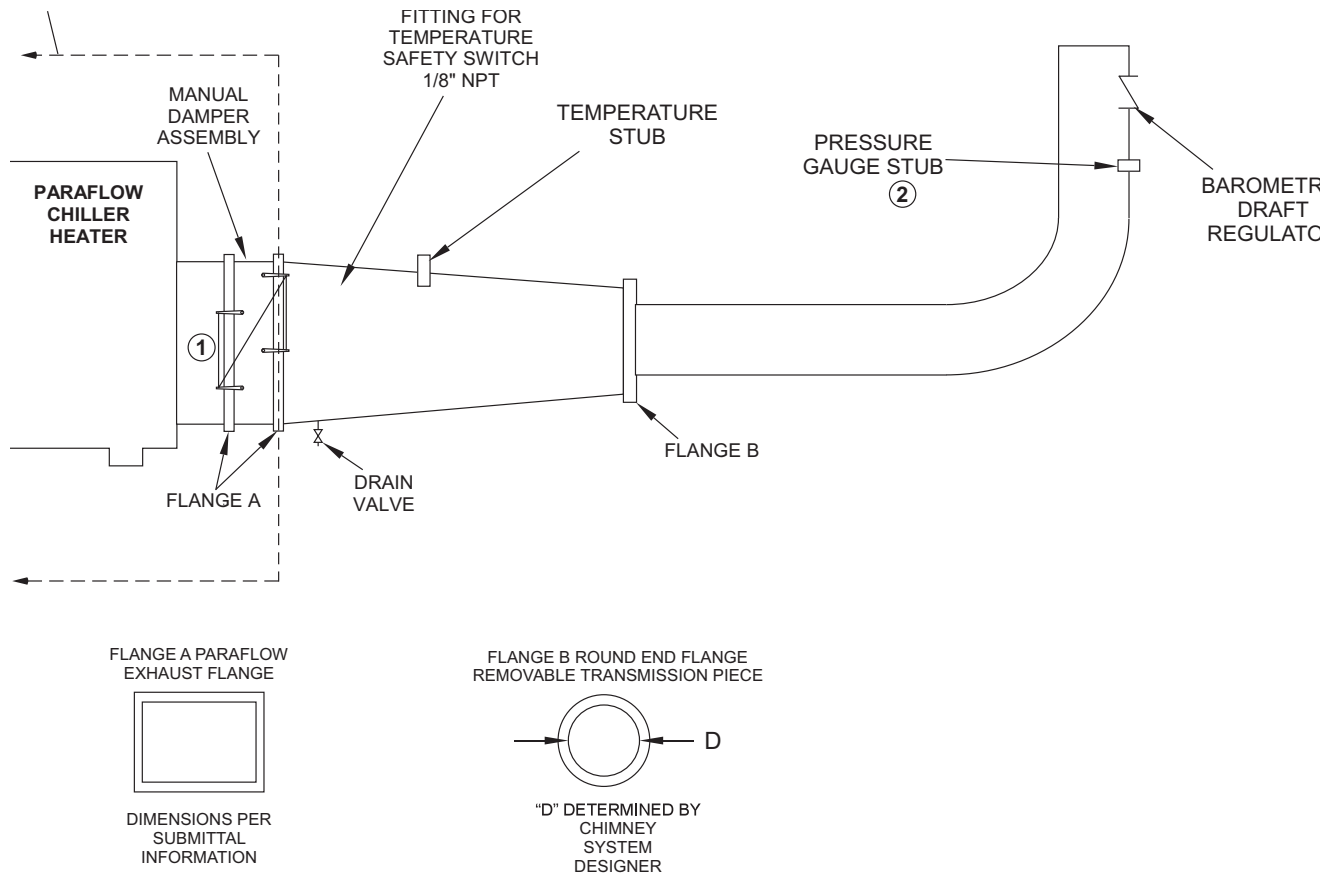
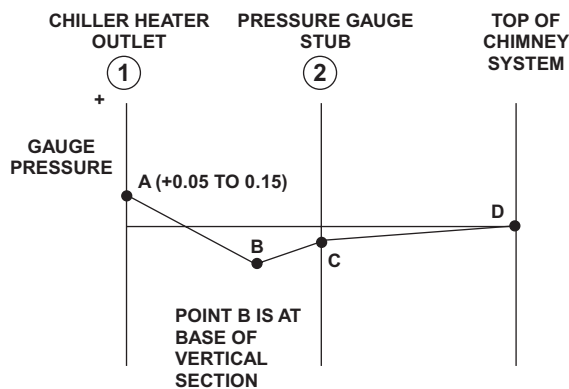

FIG. 7 – BAROMETRIC CONTROL

Gauge Pressure Profile – Chimney System with Barometric Control



Notes:

1. ΔP between A and B due to transition piece and properly positioned backdraft damper. Damper adjusted to maintain +0.05 to 0.15 in. (+1.27 to 3.81 kg/m²) water at A.
2. Maximum draft (minimum gauge pressure) occurs a base of vertical section of chimney (B). Barometric regulator will maintain steady gauge pressure at C. Maximum gauge pressure attainable with a barometric draft regulator is typically -0.06 in H₂O (-1.52 kg/m²).

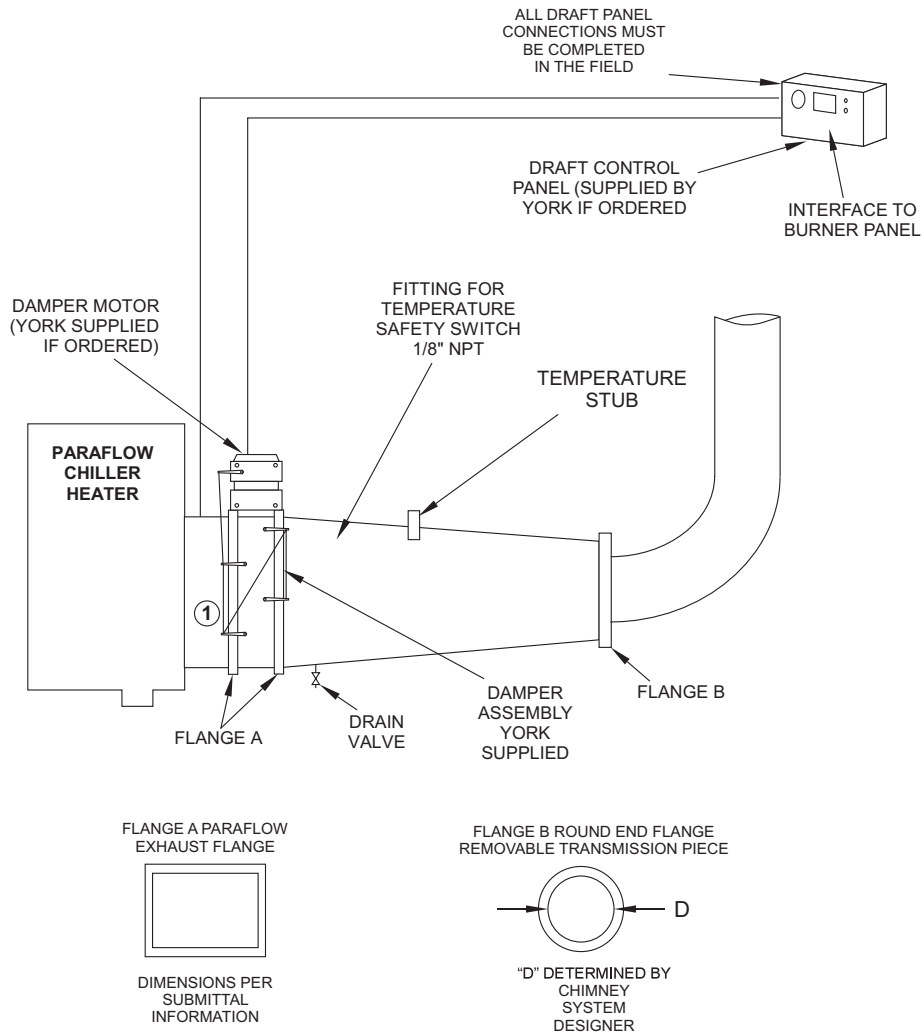
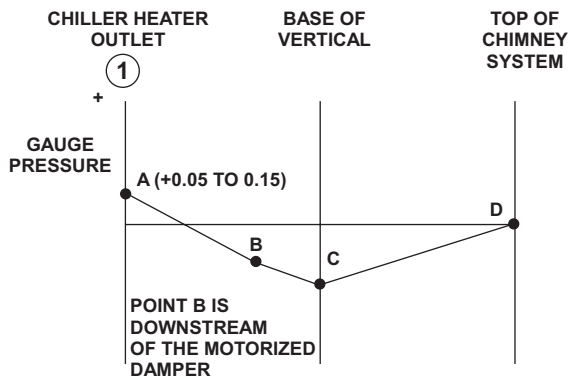

FIG. 8 – MOTORIZED DRAFT CONTROL

Gauge Pressure Profile – Chimney System with Motorized Draft Control



Notes:

1. ΔP between A and B due to transition piece and motorized damper. Damper automatically controls to maintain +0.05 to 0.15 in. (+1.27 to 3.81 kg/m²) water at A. The actual ΔP is variable and depends on the momentary gauge pressure C.
2. Maximum draft (minimum gauge pressure) occurs at base of vertical section of chimney (C). With sequential draft control, this value is allowed to drift with prevailing ambient conditions. Motorized damper controls to maintain steady gauge pressure at A.

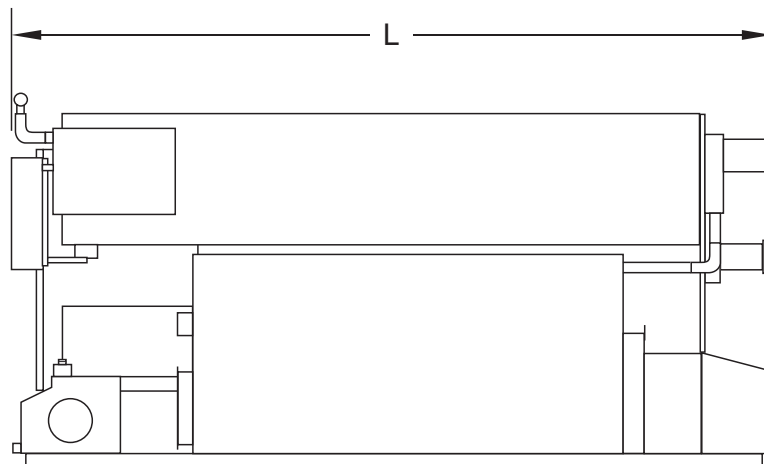
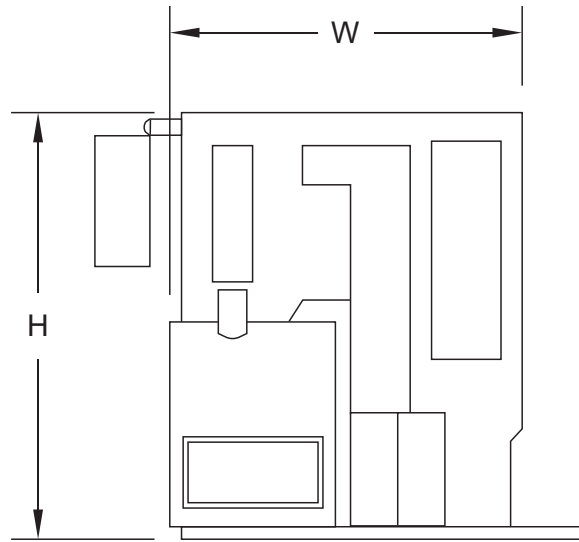

TABLE 3 – DIMENSIONAL DATA

UNIT TYPE	LENGTH		WIDTH		HEIGHT		Rigging Weight				OPERATING WEIGHT		INSULATION AREAS			
							Shipped with Charge		Shipped without Charge				COLD		HOT	
	in.	mm	in.	mm	in.	mm	lbs	kg	lbs	kg	lbs	kg	ft ²	m ²	ft ²	m ²
12SC	156	3963	73	1854	90	2286	19,800	8981	17,400	7893	20.9	9480	86	8	172	16
13SC	157	3988	73	1854	90	2286	22,000	9979	19,300	8754	23,400	10,614	86	8	194	18
14SC	195	4953	74	1877	91	2311	25,200	11,431	22,000	9979	26,700	12,111	118	11	258	24
15SL	197	5004	89	2261	108	2743	35,835	16,254	32,150	14,583	38,230	17,341	140	13	355	33
16S	197	5004	89	2261	108	2743	36,325	16,477	32,600	14,787	38,705	17,556	140	13	355	33
16SL	235	5969	91	2312	111	2820	43,630	19,790	39,100	17,735	46,635	21,153	172	16	398	37
17S	235	5969	91	2312	111	2820	44,440	20,158	39,900	18,098	47,635	21,562	172	16	398	37
18S	274	6960	93	2362	118	2997	51,750	23,473	46,300	21,001	55,475	25,163	205	19	474	44
19S	314	7976	93	2362	118	2997	61,145	27,735	54,800	24,857	65,455	29,690	237	22	506	47

INTENTIONALLY LEFT BLANK

TABLE 4 – ELECTRICAL DATA

CHILLER MODEL	VOLT CODE	WIRE VOLTAGE	NON-FUSED AMP.				MAX DUAL DISCONNECT SWITCH				ELEMENT FUSE			
			Dual fuel / oil only	Dual fuel low NOx	Gas only	Gas only low NOx	Dual fuel / oil only	Dual fuel low NOx	Gas only	Gas only low NOx	Dual fuel / oil only	Dual fuel low NOx	Gas only	Gas only low NOx
1 2SC	-17	200/208V-3PH-60HZ	48.8	52.8	46.8	50.8	60A/240V	60A/240V	60A/240V	60A/240V	70A/250V	70A/250V	60A/250V	70A/250V
	-28	230V-3PH-60HZ	44.0	47.6	42.2	45.8	60A/240V	60A/240V	60A/240V	60A/240V	60A/250V	60A/250V	60A/250V	60A/250V
	-50	380V-3PH-50HZ	24.0	25.7	23.2	24.8	30A/480V	30A/480V	30A/480V	30A/480V	30A/480V	30A/600V	35A/600V	35A/600V
	-46	460V-3PH-60HZ	22.1	23.9	21.2	23.0	30A/480V	30A/480V	30A/480V	30A/480V	30A/600V	30A/600V	30A/600V	30A/600V
13SC & 14SC	-17	200/208V-3PH-60HZ	51.2	55.2	48.6	52.6	60A/240V	60A/240V	60A/240V	60A/240V	70A/250V	70A/250V	60A/250V	70A/250V
	-28	230V-3PH-60HZ	46.2	49.8	43.8	47.4	60A/240V	60A/240V	60A/240V	60A/240V	60A/250V	60A/250V	60A/250V	60A/250V
	-50	380V-3PH-50HZ	25.0	26.6	23.9	25.6	30A/480V	30A/480V	30A/480V	30A/480V	35A/600V	35A/600V	30A/600V	35A/600V
	-46	460V-3PH-60HZ	23.2	25.0	22.0	23.8	30A/480V	30A/480V	30A/430V	30A/430V	30A/600V	30A/600V	30A/600V	30A/600V
15SL & 16S	-17	200/208V-3PH-60HZ	68.6	72.6	65.3	69.3	100A/240V	100A/240V	100A/240V	100A/240V	90A/250V	100A/250V	80A/250V	90A/250V
	-28	230V-3PH-60HZ	63.1	66.7	60.0	63.6	100A/240V	100A/240V	100A/240V	100A/240V	80A/250V	90A/250V	90V/250V	80A/250V
	-50	380V-3PH-50HZ	35.6	37.2	34.2	35.8	60A/480V	60A/480V	60A/480V	60A/480V	50A/600V	50A/600V	45A/600V	50A/600V
	-46	460V-3PH-60HZ	31.6	33.4	30.1	31.9	60A/480V	60A/480V	60A/480V	60A/480V	40A/600V	45A/600V	40A/600V	40A/600V
16SL, 17S & 18S	-17	200V-3PH-60HZ	97.5	97.5	97.5	97.5	200A/240V	200A/240V	100A/240V	200A/240V	125A/250V	125A/250V	125A/250V	125A/250V
	-28	230V-3PH-60HZ	90.3	90.3	90.3	90.3	100A/240V	100A/240V	100A/240V	100A/240V	125A/250V	125A/250V	100A/250V	125A/250V
	-50	380V-3PH-50HZ	54.0	54.0	54.0	54.0	60A/480V	60A/480V	60A/480V	60A/480V	60A/600V	60A/600V	60A/600V	60A/600V
	-46	460A-3PH-60HZ	45.6	45.6	45.6	45.6	60A/480V	60A/480V	60A/480V	60A/480V	60A/600V	60A/600V	60A/600V	60A/600V
19S	-17	200V-3PH-60HZ	115.2	115.2	115.2	115.2	200A/240V	200A/240V	200A/240V	200A/240V	125A/250V	125A/250V	125A/250V	125A/250V
	-28	230V-3PH-60HZ	108.0	108.0	108.0	108.0	200A/240V	200A/240V	200A/240V	200A/240V	125A/250V	125A/250V	125A/250V	125A/250V
	-50	380V-3PH-50HZ	63.8	63.8	63.8	63.8	100A/480V	100A/480V	100A/480V	100A/480V	80A/600V	80A/600V	80A/600V	80A/600V
	-46	460A-3PH-60HZ	54.4	54.4	54.4	54.4	100A/480V	100A/480V	100A/480V	100A/480V	70A/600V	70A/600V	60A/600V	70A/600V

NOTES:

1. Incoming wire to chiller must be copper only. Aluminum wiring is not permitted.
2. Lugs in Power Panel will accept incoming wire range of #14 AWG through #1 AWG
3. Electrical system must be securely grounded.
4. Field wiring must conform to NEC and all other applicable local codes.
5. Data is for chillers using Powerflame burners

SOL. PUMP FLA	REFRIG. PUMP FLA	PURGE PUMP FLA	SPRAY PUMP FLA	ELEC. PNL FLA	BURNER PANEL FLA				TOTAL CURRENT				TOTAL KW			
					Dual fuel / oil only	Dual fuel low NOx	Gas only	Gas only low NOx	Dual fuel / oil only	Dual fuel low NOx	Gas only	Gas only low NOx	Dual fuel / oil only	Dual fuel low NOx	Gas only	Gas only low NOx
22.0	6.2	1.7	—	5.0	8.4	12.4	6.4	10.4	43.3	47.4	41.3	45.3	9.5	10.7	9.0	10.1
20.0	5.6	1.5	—	4.3	7.6	11.2	5.8	9.4	39.0	42.7	37.2	40.9	9.7	10.8	9.1	10.2
11.0	3.1	0.9	—	2.6	3.4	5.1	2.6	4.2	21.0	22.7	20.4	21.9	9.5	10.3	9.0	9.9
10.0	2.8	0.8	—	2.2	3.8	5.6	2.9	4.7	19.5	21.3	18.7	20.4	9.7	10.8	9.0	10.3
22.0	6.2	1.7	—	5.0	10.8	14.8	8.2	12.2	45.7	49.7	43.1	47.1	10.8	12.5	10.0	11.2
20.0	5.6	1.5	—	4.3	9.8	13.4	7.4	11.0	41.2	44.8	38.8	42.4	11.3	12.7	10.3	11.8
11.0	3.1	0.9	—	2.6	4.4	6.0	3.3	5.0	22.0	23.7	21.1	22.6	10.5	11.7	9.8	11.0
10.0	2.8	0.8	—	2.2	4.9	6.7	3.7	5.5	20.6	22.4	19.5	21.2	11.3	12.7	10.3	11.8
27.6	13.8	1.7	—	5.0	15.4	19.4	12.1	16.1	63.5	67.6	58.4	64.2	15.9	17.8	14.9	17.5
25.0	12.0	1.5	—	4.3	14.0	17.6	10.9	14.5	56.8	60.4	53.7	57.3	16.7	28.1	15.4	21.1
15.0	7.0	0.9	—	2.6	6.3	7.9	4.9	6.5	31.8	33.5	30.4	32.0	15.6	16.7	14.6	16.4
12.5	6.0	0.8	—	2.2	7.0	8.8	5.5	7.3	28.4	30.2	27.0	28.7	16.7	18.1	15.5	14.0
40.6	13.8	1.7	13.2	5.0	15.4	19.4	12.1	16.1	89.7	93.8	73.7	90.4	20.3	22.2	19.3	26.7
36.8	12.0	1.5	12.0	4.3	14.0	17.6	10.9	14.5	80.6	84.2	72.4	81.1	21.1	22.5	19.8	27.1
19.0	7.0	0.9	7.0	2.2	6.3	7.9	4.9	6.5	42.8	44.5	44.0	43.0	20.6	21.7	19.6	18.8
18.4	6.0	0.8	6.0	2.6	7.0	8.8	5.5	7.3	40.3	42.1	36.7	40.6	21.1	22.5	19.9	20.6
40.6	13.8	1.7	33.1	5.0	27.9	31.9	24.5	28.3	122.1	126.2	108.3	122.5	28.9	31.2	27.7	42.6
36.8	12.0	1.5	30.0	4.3	25.3	28.9	21.9	25.6	109.9	113.5	101.7	110.2	30.2	31.6	28.8	30.3
19.0	7.0	0.9	17.0	2.2	13.0	13.0	13.0	13.0	59.5	59.5	59.1	59.5	30.2	30.2	30.2	30.2
18.4	6.0	0.8	15.0	2.6	12.6	14.4	11.0	12.8	54.9	56.8	51.3	55.1	30.1	31.6	28.9	30.3

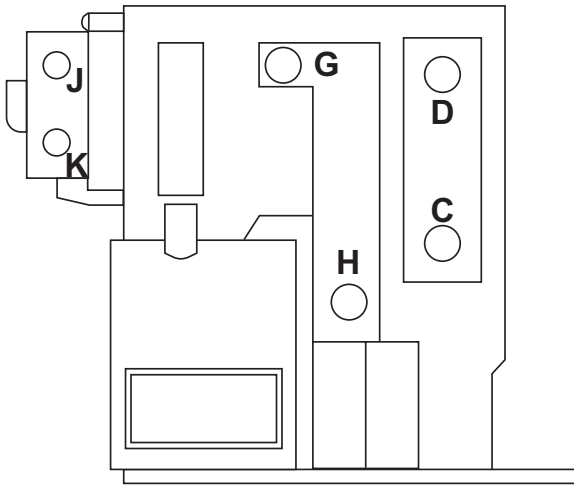

EXHAUST END

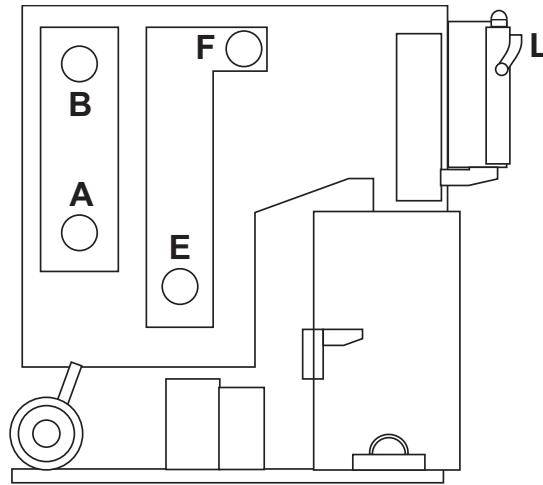

BURNER END

See Note 5

EVAPORATOR NOZZLE ARRANGEMENTS

NO. OF PASSES	NOZZLE ARRANGEMENT	IN	OUT
3	E1	A	D
	E4	C	B
2, 4	E5	A	B
	E7	C	D

HEATER NOZZLE ARRANGEMENTS

NO. OF PASSES	NOZZLE ARRANGEMENT	IN	OUT
2	HW2	K	J
3	HW3	L	J
4	HW4	K	J

TOWER WATER NOZZLE ARRANGEMENTS

NO. OF ABS. PASSES	NOZZLE ARRANGEMENT	IN	OUT
1,3	C1	E	F
	C2	H	G
2	C3	E	G
	C4	H	F

NOZZLE SIZES

YPC-DF	EVAP.			ABS./COND.			HIGH TEMP HOT WATER HEATER		
	NUMBER OF PASSES								
	2	3	4	1*	2*	3*	2	3	4
12SC	6"	6"	4"	6"	6"	4"	4"	4"	3"
13SC	6"	6"	4"	6"	6"	4"	4"	4"	3"
14SC	6"	6"	4"	6"	6"	4"	4"	4"	3"

* Number of passes refers to the number of absorber passes only. The condenser is always one-pass with nozzle sizes that match the absorber.

Notes:

1. Choose desired nozzle arrangement – water boxes are not interchangeable.
2. Standard water nozzles are furnished as welding stub-outs with Victaulic grooves, allowing the option of welding, flanges, or the use of Victaulic couplings. Factory installed, class 150 (ANSI B.16.5, round skip on, forged steel with 1/16" inch raised face), water flanged nozzles are optional. Companion flanges, nuts, bolts, and gaskets are not furnished.
3. Connected piping should allow for removal of compact water box for tube access and cleaning.
4. Tower water must enter the absorber first for proper performance.
5. Nozzle L faces upward.

Nozzle Arrangements: 15SL and Larger

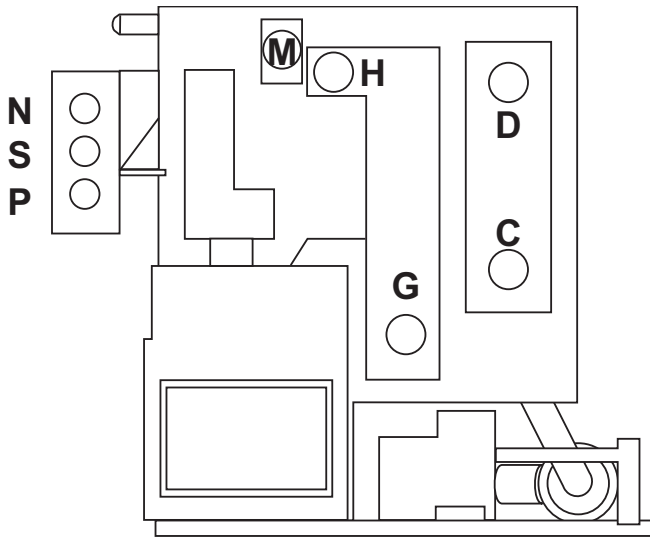

EXHAUST END

EVAPORATOR NOZZLE ARRANGEMENTS

NO. OF PASSES	NOZZLE ARRANGEMENT	IN	OUT
3	E1	A	D
	E4	C	B
2, 4	E5	A	B
	E7	C	D

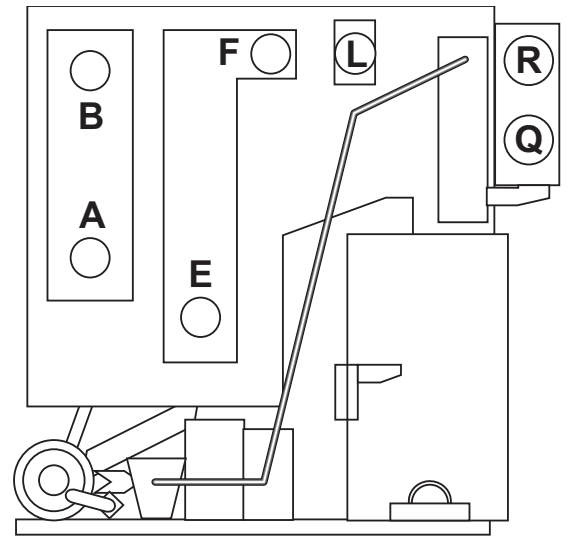

BURNER END

HEATER NOZZLE ARRANGEMENTS

NO. OF PASSES	NOZZLE ARRANGEMENT	IN	OUT
1	HW1	R	S
2	HW2	P	N
3	HW3	Q	N
4	HW4	P	N

TOWER WATER NOZZLE ARRANGEMENTS

NO. OF PASSES	NOZZLE ARRANGEMENT	ABSORBER		CONDENSER	
		IN	OUT	IN	OUT
1	C1	F	H	M	L
	C2	H	F	L	M
2	C3	E	F	L	M
	C4	G	H	M	L
3	C1	E	H	M	L
	C2	G	F	L	M

Same Notes as other Nozzle Arrangements apply. See pg. 26.

NOZZLE SIZES

YPC-DF	EVAPORATOR			ABS./COND.			HIGH TEMP. HOT WATER HEATER			
	NUMBER OF PASSES									
	2	3	4	1*	2*	3*	1	2	3	4
15SL/16S	8"	6"	6"	N/A	10"	8"	—	6"	6"	4"
16SL/17S	8"	6"	6"	N/A	10"	8"	8"	6"	6"	—
18S	8"	6"	6"	N/A	10"	8"	8"	6"	6"	—
19S	8"	6"	6"	12"	10"	8"	8"	6"	6"	—

* Number of passes refers to the number of absorber passes only. The condenser is always one-pass with nozzle sizes that match the absorber.

Guide Specifications

GENERAL

Provide YORK ParaFlow **YPC** Direct-Fired Two-Stage Absorption Chiller-Heater(s) capable of producing chilled water and/or hot water per the capacities shown on drawings and schedules.

Each chiller-heater shall be of hermetic design, and undergo a series of leak tests finishing with helium/mass spectrometer test.

Chiller-heater unit, including combustion components, shall be listed by Underwriter's Laboratories as a package and shall bear the appropriate U.L. label.

Chiller-heater shall ship as a one-piece assembly ready for connection to the building water, fuel, and electrical systems. Purge pump, chilled-water flow switch, gas train and exhaust-gas temperature sensor shall be shipped loose for field installation.

The burner and burner-control panel shall be factory mounted, wired, tested, and shipped preinstalled as integral components of the chiller-heater.

Chiller-heater to ship complete with factory-balanced LiBr and refrigerant precharged in unit in order to simplify and expedite field start up. Unit shall ship with a nitrogen gas holding charge to eliminate the possibility of air entering unit during transport and to permit the verification of a leak tight unit upon delivery.

Purchase price to include parts and labor warranty for a period of one year from start up or eighteen months from delivery, whichever occurs first.

CONSTRUCTION

The chiller-heater unit to consist of one first-stage (high temperature) generator, solution heat exchangers, and main shell. The main shell shall include the condenser, second stage (low temperature) generator, evaporator, and absorber.

Crossover routing cooling water from the absorber to the condenser (for Models 12SC-14SC: shall be integral to machine design)(Models 15SL and larger: shall be an external crossover provided by the manufacturer), eliminating the need for a customer supplied crossover pipe.

The flow of solution shall be initiated by a hermetic solution pump, located beneath the absorber, and shall be divided into two parallel paths, one leading to the first stage generator and the other to the second stage generator. This parallel flow design shall permit each stream of solution to be concentrated only once in order to limit the maximum concentration of LiBr and thus minimize the risk of crystallization.

TUBE MATERIALS

The first-stage generator tubes shall be seamless carbon steel boiler tubes, 0.138" (3.5 mm) wall thickness. The evaporator, absorber, and condenser shall all be seamless copper 5/8" (15.875 mm) OD, .025" (0.635 mm) wall for Models 12SC-14SC and 3/4" (19.05 mm) OD, .028" (0.71 mm) wall for Models 15SL and larger, with enhanced surface as required to meet given capacity. The second-stage generator tubes shall be copper 5/8" (15.875 mm) OD, .025" (0.635 mm) wall for Models 12SC-14SC, and 3/4" (19.05 mm) OD, .028" (0.71 mm) wall for Models 15SL and larger.

WATER BOXES

Water boxes shall be removable to permit tube cleaning and replacement. Water-circuit tubing to be replaceable from either end of chiller-heater unit. Stubout water connections having Victaulic grooves shall be provided as standard (ANSI flanged connections are optional). All water boxes and associated water-circuit nozzles and tube bundles shall be designed for 150 psig (1.0 MPa) working pressure and shall be hydrostatically tested to 225 psig (1.6 MPa). Vent and drain connections shall be provided on each water box.

SIGHT GLASSES

Unit shall be equipped with no fewer than six (6) sight glasses to permit exact adjustment of solution and refrigerant levels under full load conditions to ensure efficient and trouble free operation. Sight glasses to be located as follows: upper evaporator, lower evaporator, first-stage generator, second-stage generator, absorber, oil trap.

SPRAY DISTRIBUTION

Solution and refrigerant distribution shall be accomplished by use of a drip apparatus which produces a fine, laminar film on the outside of the tube bundles.

PUMPS

Solution and refrigerant pumps shall be hermetically-sealed, self-lubricating, totally-enclosed, liquid-cooled, factory-mounted, wired, and tested. Suction and discharge connections of solution and refrigerant pumps shall be welded to chiller-heater unit piping. Flanged pump connections are not acceptable.

ISOLATION VALVES

Suction and discharge connections for the solution and refrigerant pumps shall be equipped with factory welded isolation valves to permit the servicing of hermetic pump assemblies without any loss of solution or leakage of air into the chiller-heater.

SOLUTION VALVES

Valves used for adjusting solution flow shall be fully welded or brazed to prevent leakage of air into unit. Valve operator shall be covered with a seal cap to eliminate the possibility of stem leakage. Fittings between valve body and unit piping to be welded. Threaded valve connections are not acceptable.

PURGING SYSTEM

Chiller-heater shall be equipped with a purge system which will constantly remove noncondensable vapors from the unit during operation using an eductor. Noncondensibles shall be stored in a purge chamber until they can be removed through the use of a purge pump.

The chiller control panel shall include a SmartPurge system that will automatically sense the amount of non-condensibles in the purge chamber and empty the tank whenever necessary. The SmartPurge system shall eliminate the need for an operator to ever manually empty the purge chamber. In addition, the control panel shall monitor the frequency of purge cycles and alert the chiller operator, through a unique control panel warning message, if the number of purges exceeds normal levels.

Purge systems that utilize a palladium cell (for venting hydrogen) on the purge chamber to prolong the time between emptying the purge chamber shall not be acceptable, since the vented hydrogen is the major byproduct of the corrosion caused by a leak. If a system with a palladium cell is offered, the purchase price must include a contract for quarterly leak checking of the machine.

The purge pump shall be of an oil rotary two-stage design, and shall be furnished complete with a 1/2 HP, 3-Phase, ODP motor, and all required accessories including base, pulleys, and belt guard. Purge pump shall be equipped with stainless steel vanes.

LITHIUM BROMIDE AND REFRIGERANT CHARGE

LiBr solution shall contain a corrosion inhibitor additive, ADVAGuard 750, to minimize the rate of copper and ferrous metal corrosion on the solution side of the unit. The corrosion inhibitor, when applied at the concentrations prescribed by the unit manufacturer, shall not cause the inhibited lithium-bromide solution to be classified as a hazardous waste under the Resource Conservation and Recovery Act. Lithium-bromide solutions containing chromates or arsenites as a corrosion inhibitors shall not be acceptable. If systems are bid that include **LiBr** solutions containing chromate or arsenate inhibitors the purchase price shall include a contract supplying disposal services for removal of bromide as a result of regular service or when the machine is being taken out of commission.

BURNER

Each chiller-heater unit to be furnished complete with a forced-draft flame-retention burner capable of firing on one or more of the following fuels (as specified):

- Natural gas
- Propane
- No. 2 fuel oil

Burner shall ship premounted and prewired to chiller-heater unit.

Minimum turndown ratio, while maintaining efficient combustion throughout the entire firing range, will be 3 to 1. Fuel changeover shall be accomplished by a manual fuel-changeover switch (automatic fuel changeover is optional). There shall be no need for mechanical changes or other adjustments when switching from one fuel to another.

Burner shall be listed by Underwriters Laboratories and shall bear the appropriate U.L. label. Burner shall also meet the requirements of CSD-1 as standard. (IRI, FM, and other code approvals are available as an option).

Burner shall be of welded steel construction. The combustion head shall incorporate a multi-blade, stainless-steel, flame-retention diffuser. The gas firing head shall be of the multiport type and constructed such as to place annular gas distribution openings between two parallel air flow streams to achieve maximum fuel/air mixing.

Burner shall be capable of being retrofitted to low NO_x operation without modification to, or replacement of any major component assemblies initially supplied. The original burner blower housing, blower, blast tube (head), and diffuser assembly shall be used. Future retrofit hardware shall be limited to a factory supplied, bolt on, low NO_x kit that shall be U.L. approved for field retrofit. The completed retrofit shall be in accordance with the U.L. listed low NO_x system normally supplied by the burner manufacturer for new applications.

Low NO_x retrofit shall be accomplished without the need for derating the burner input or output, and without the need to increase gas supply pressure or electrical power supply.

The design shall be of the "multi-nozzle, dual-annular" type which includes an adjustable premix air/gas chamber constructed such that a mixture of primary air and gas will be introduced into the combustion area, upstream of the secondary combustion air and ignition introduction zone.

Combustion air shall be supplied by an integral-mounted blower assembly incorporating a di-

Guide Specifications - continued

rect-drive, 3-phase motor. A dual-blade damper assembly located on the inlet side of the blower wheel shall meter the combustion air flow. Design shall permit the disconnecting and locking of either damper if firing rates are at minimum burner input ratings. Damper-blade axle shafts shall utilize brass sleeve bearings. Contacts shall be provided in the burner panel to open/close fresh air dampers that allow combustion air supply into the mechanical room.

The burner ignition system which will light either the main gas or oil flame shall utilize (natural or propane) gas as the pilot fuel source. The gas pilot-system component shall include spark-ignited pilot assembly, 600 Volt ignition transformer, pilot solenoid valve, pilot gas pressure regulator and manual gas shutoff cock. The flame proving system shall incorporate an ultra violet flame detector which will monitor both the pilot and main flames. The pilot assembly shall fit within the confines of the blast tube avoiding special burner front plate pilot cut outs.

The fuel/air control system shall be of the full modulation type. The main On-Off gas supply shall be controlled by dual-motorized gas valves. The main On-Off oil supply shall be controlled by dual-solenoid oil valves. A modulating motor shall control the modulated positioning of the air inlet dampers, butterfly-type, gas proportioning valve and a metering-type, oil valve to best meet system load conditions.

A Varicam™ cam-actuated, characterized fuel metering device shall be provided as an integral part of the burner fuel metering system. The system shall be U.L. listed and capable of providing an adjustable and accurately repeatable fuel/air ratio throughout the entire firing range of both gas and liquid fuels. The system shall be capable of providing a constant or a linearly adjusted fuel/air ratio in order to satisfy individual application requirements. Each system shall be complete with fourteen (14) separately-adjustable, cam-development set points. Each setpoint shall be complete with locking set screw. The cam follower shall be equipped with a double spring set in order to ensure maximum reliability. All bearing points shall be provided with oil-impregnated bronze bushings requiring no field lubrication.

The positioning of the modulating motor shall be controlled by a 4-20 mA control signal emanating from the chiller-heater unit's microcomputer control center panel. When the operating control is satisfied the burner shall shut off and return to the low-fire start position. The modulating motor shall provide an electrical interlock to ensure a guaranteed low-fire start position prior to the pilot trial for ignition sequence.

The gas control train shall be prepped and prewired with suitable junction boxes and terminal strips to burner panel terminal connections. The gas train shall contain the following components: manual-shutoff cock, main gas-pressure regulator, low and high gas-pressure switches, two (2) U.L. listed leak test cocks, burner manifold gas-pressure gauge, two (2) main, motorized, gas valves (for gas inputs of 5.0 MMBTU/HR and lower), two (2) main, motorized, gas valves – one (1) with proof of closure interlock switch (for gas inputs above 5.0 MMBTU/HR), and one (1) normally-open vent valve sized according to IRI requirements.

The oil control train (when specified) shall incorporate U.L. approved components supplied by the burner manufacturer to provide the specified fuel/air control operation. The system shall utilize a single high-pressure oil nozzle of the internal bypass type. The nozzle oil train shall include one (1) 300# (136.1 kg) gauge to read nozzle return-oil pressures.

The high-pressure, nozzle-supply oil pump shall be a two (2) gear type capable of producing 300 psig (2.1 MPa) discharge pressure and 15 inches Hg. vacuum. It shall be a separate unit mounted on its own support base with direct drive motor. The oil pump unit shall be complete with removable mesh-type oil strainer, 0-300 psig (2.1 MPa) oil-nozzle pressure gauge, nozzle line, main and auxiliary-solenoid safety-shutoff oil valves and low oil-pressure switch. Oil-nozzle bypass line shall utilize dual check valves.

Prepurge operation of the modulating motor shall provide an electrical interlock at the 60% air flow position of the burner damper and another electrical interlock at the damper low fire start position before the ignition sequence will begin.

The flame safeguard control shall provide fully automatic prepurge and post-purge sequencing of the burner blower motor, interrupted ignition system, and fuel/air flow components with an ultra violet sensor for flame detection. The flame safeguard control shall be Honeywell Model RM 7840L.

UNIT CONTROLS

Each unit shall be furnished complete with a factory-mounted and prewired control system. Unit controls to be furnished shall include a total of three (3) enclosures; a Power Panel, a Burner Control Panel, and a ParaFlow MicroComputer Control Center Panel.

Power Panel – The Power Panel enclosure shall be NEMA 1 and shall house the following components: single-point wiring connection for incoming power supply;

non-fused disconnect switch; motor starters, complete with current and thermal overload protection, for solution pump, refrigerant pump, and purge pump (current overloads only); and a 115VAC 50/60 Hz Control Power Transformer.

Burner Control Panel – The Burner Control Panel enclosure shall be constructed of 16 gauge steel and shall be equipped with a hinged and removable front-access door and shall house all combustion related safeties and control logic. The Burner Panel shall be designed to interface directly with the ParaFlow MicroComputer Control Center Panel to provide integrated burner control for the chillerheater. The Burner Control Panel shall be premounted and prewired to the chiller-heater and shall include the following components:

- Honeywell RM 7840L flame safeguard
- Burner On/Off switch
- 115V control power transformer
- Motor starters, complete with current overload protection for blower motor and remote oil pump (if used)
- Electrical transient suppressors
- Alarm bell
- Fresh air damper open/close contacts
- Flame failure indication contacts
- Exhaust gas temperature limit switch

NOTE: *Remote exhaust gas temperature sensor to be field wired and installed in exhaust breaching*

- Indicating lamps, labeled as follows:
- Call for Operation
- Ignition On
- Main Fuel

ParaFlow MicroComputer Control Center Panel – The ParaFlow MicroComputer Control Center enclosure shall be NEMA 1 and be equipped with hinged access door with lock and key. All temperature sensors, pressure transducers, and other control devices necessary to sense unit operating parameters to be factory-mounted and wired to panel. The ParaFlow MicroComputer Control Center Panel shall include a 40 character alphanumeric display showing all system parameters in the English language with numeric data in English (or metric) units (°F, PSIA, or °C, KPa respectively).

115V control voltage will be supplied through a 1 KVA power transformer located in the Power Panel and will be factory wired to the ParaFlow MicroComputer Control Center Panel.

Terminal blocks will be provided for all external safety and control interlocks.

JOHNSON CONTROLS

The operating program shall be stored in non-volatile memory (EPROM) to eliminate chiller failure due to AC power failure/battery discharge. In addition, programmed setpoints shall be retained in lithium battery-backed RTC memory for a minimum of 5 years.

All wiring and control interlocks between the ParaFlow MicroComputer Control Center Panel and the Burner Control Panel shall be factory installed and tested prior to unit shipment.

System Operating Information – During normal operation the following operating parameters shall be accessible via the ParaFlow MicroComputer Control Center Panel:

- Return and leaving chilled-water temperatures
- Return and leaving hot-water temperatures
- Return and leaving condenser-water temperatures
- First-stage generator pressure
- First-stage generator temperature
- Refrigerant temperature
- Solution temperature
- Indication of refrigerant/solution/purge pump/manual dilutions cycle operation
- Operating hours
- Number of starts
- Number of Purge Cycles (last 7 days and total cumulative)
- Burner firing-rate command (in %)

Capacity Control – The ParaFlow MicroComputer Control Center Panel shall automatically control the burner firing rate to maintain the programmed leaving chilled water or hot water setpoints for cooling or heating loads ranging from 30% to 100% of design. The burner firing rate shall also be adjustable manually from the ParaFlow MicroComputer Control Center Panel to any setting between 30% and maximum when automatic operation is not desired and when the burner firing rate is not being inhibited by a specific operating condition.

Safety Shutdowns – Panel shall be pre-programmed to shut the unit down and close “safety shutdown” contacts under any of the following conditions:

- Refrigerant- or Solution-pump thermal or current overload
- Low refrigerant temperature
- First-stage generator high temperature or pressure
- First-stage generator low solution level
- Burner alarm indication

Guide Specifications - continued

- Burner Panel malfunction (i.e. any combustion related safety shutdown)
- Loss of chilled water flow
- Power failure (when “Automatic Restart after Power Failure” option is not utilized)
- Incomplete dilution cycle operation due to one of the following conditions:
 - Power failure
 - Solution/refrigerant pump overloads
 - Low refrigerant temperature
 - Loss of chilled water flow
 - Auxiliary safety shutdown for field supplied signals

All safety shutdowns will require unit to be manually restarted.

Whenever a safety shutdown occurs the ParaFlow Micro-Computer Control Center Panel shall record the following information and store it in memory (or communicate it to remote printer): day and time of shutdown; reason for shutdown; type of restart required (automatic restart is displayed, manual restart is implied); all system operating information displayed just prior to shutdown.

Warning Conditions – ParaFlow MicroComputer Control Center Panel shall close warning contacts and generate a unique warning message whenever one of the Following operating conditions is detected:

- Low refrigerant temperature
- High generator temperature or pressure
- High or low entering condenser-water temperature
- Purge-pump current overload
- Faulty solution dilution temperature sensor

Unit shall not shut down under a warning condition but shall have its heat input (i.e. input burner firing rate) inhibited in an attempt to prevent an actual safety shutdown from occurring.

Cycling Shutdowns – Control center panel shall be preprogrammed to shut unit down whenever one of the following conditions is detected:

In Cooling Mode:

- Loss of condenser water flow
- Low leaving chilled-water temperature
- Power failure (when “Automatic Restart after Power Failure” option is selected).

In Heating Mode:

- Loss of hot-water flow

- High leaving hot water temperature
- Power failure (when “Automatic Restart after Power Failure” option is selected).

Cycling shutdowns shall permit unit to automatically restart when pre-programmed thresholds are reached. Following a cycling shutdown, cycling shutdown contacts shall close and cycling shutdown messages shall be displayed and recorded in a similar fashion as safety shutdown messages.

Programmable Setpoints – The following parameters shall be programmable directly from the key pad using a security access code to prevent unauthorized changes:

- Leaving chilled-water temperature in 0.1°F (0.1°C) increments
- Leaving hot-water temperature in 0.1°F (0.1°C) increments
- Remote-reset chilled-water temperature range
Remote-reset hot-water temperature range
- 7 day schedule for unit start/stop
- Holiday schedule for unit start/stop
Pull down demand
- Time clock/calendar date

Remote reset signals for leaving chilled- and hot-water temperature setpoints shall be 1 to 11 second pulse width modulated (PWM) as standard. An optional field-installed card file shall be available to permit the following reset signals to be used in lieu of a 1 to 11 second PWM signal: 4-20 mA DC, 0-10VDC, and contact closure.

7 day scheduling shall permit one unit start and stop to be made each day at discrete times over a seven day calendar basis through the use of an integral timeclock. In addition, a separate holiday schedule shall be programmable up to one week in advance. All major system components such as chilled water pumps, condenser water pumps, and hot water pumps shall be able to be controlled from the ParaFlow MicroComputer Control Center Panel to start and stop with the chiller-heater to minimize system energy usage.

The pull-down demand feature shall permit ramp loading of burner firing rate upon unit start up. Programmable inputs include initial firing rate (30% to maximum), final firing rate (30% to maximum), and duration of pulldown demand period (0 to 255 minutes).

Concentration Calculator – The micropanel shall monitor the first stage generator concentration to prevent operation at an unsafe concentration. Concentration

shall be tied into both the Warning Conditions and Safety Shutdown systems. Also included shall be an operator interface concentration calculator. An operator shall be able to use the concentration calculator to determine concentration by inputting set of conditions. When an operator inputs any two of three parameters (bromide solution temperature, saturation temperature, and pressure) and the micropanel shall display the concentration. The display shall also indicate if the input conditions are in the crystallization zone.

Data Logging – The ParaFlow MicroComputer Control Center Panel shall contain an RS-232 port to enable the transmission of all operating, setpoint, and shutdown information to a remote printer (by others). This transmission can occur as needed or automatically on predetermined intervals.

In the case of a safety or cycling shutdown, the RS-232 port shall transmit all operating data detected prior to the shutdown as well as the time and cause of the shutdown. In addition, a history of the last four safety or cycling shutdowns, with the exception of power failures, shall be retained in memory and can be printed as well.

BAS REMOTE CONTROL

A communication interface permitting complete exchange of chiller data with any BAS System is available with an optional Metasys™ translator. The Metasys™ translator also allows BAS System to issue commands to the chiller to control its operation. Metasys™ translators come in two models, controlling up to 4 chillers and 8 chillers respectively.

The ParaFlow MicroComputer Control Center Panel shall be able to communicate all data accessible from the keypad to a remote integrated DDC processor through a single shielded cable. This information will include all unit temperatures, pressures, safety alarms, and status readouts for complete integrated plant control, data logging, and local/remote display of operator information. The single shielded cable shall also allow the remote integrated DDC processor to issue operating commands to the ParaFlow MicroComputer Control Center including but not limited to the following:

- Remote unit start/stop
- Remote chilled-water temperature reset
- Remote hot-water temperature reset

The ParaFlow MicroComputer Control Center Panel shall also be capable of providing a limited interface to other building automation systems in order to permit the following operations:

- Remote unit start/stop
- Remote chilled-water temperature reset
- Remote hot-water temperature reset
- Remote readout of status including
 - Unit ready to start
 - Unit operating
 - Unit safety shutdown
 - Unit cycling shutdown

Printed on recycled paper

Form 155.17-EG4 (1111) Supersedes: 155.17-EG4 (1011)
© 2011 Johnson Controls, Inc. P.O. Box 423, Milwaukee, WI 53201 Printed in USA
www.johnsoncontrols.com

