



**PACKAGED ROOFTOP
AIR CONDITIONING UNITS**

QUICK START-UP GUIDE

New Release

Form 100.50-SU2 (1207)

035-21979-100



**Packaged Rooftop
Air Conditioning Units**

YPAL 050

YPAL 051

YPAL 060

YPAL 061

DESIGN LEVEL F

IPU CONTROL



ld13271

**ASHRAE
90.1
COMPLIANT**

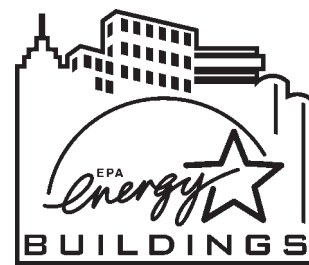

ALLY

IMPORTANT!

READ BEFORE PROCEEDING!

GENERAL SAFETY GUIDELINES

This equipment is a relatively complicated apparatus. During installation, operation, maintenance or service, individuals may be exposed to certain components or conditions including, but not limited to: refrigerants, oils, materials under pressure, rotating components, and both high and low voltage. Each of these items has the potential, if misused or handled improperly, to cause bodily injury or death. It is the obligation and responsibility of operating/service personnel to identify and recognize these inherent hazards, protect themselves, and proceed safely in completing their tasks. Failure to comply with any of these requirements could result in serious damage to the equipment and the property in

which it is situated, as well as severe personal injury or death to themselves and people at the site.

This document is intended for use by owner-authorized operating/service personnel. It is expected that this individual possesses independent training that will enable them to perform their assigned tasks properly and safely. It is essential that, prior to performing any task on this equipment, this individual will have read and understood this document and any referenced materials. This individual will also be familiar with and comply with all applicable governmental standards and regulations pertaining to the task in question.

SAFETY SYMBOLS

The following symbols are used in this document to alert the reader to areas of potential hazard:



DANGER indicates an imminently hazardous situation which, if not avoided, will result in death or serious injury.



CAUTION identifies a hazard which could lead to damage to the machine, damage to other equipment and/or environmental pollution. Usually an instruction will be given, together with a brief explanation.



WARNING indicates a potentially hazardous situation which, if not avoided, could result in death or serious injury.

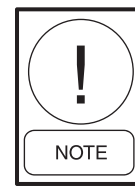

NOTE is used to highlight additional information which may be helpful to you.



External wiring, unless specified as an optional connection in the manufacturer's product line, is not to be connected inside the micro panel cabinet. Devices such as relays, switches, transducers and controls may not be installed inside the micro panel. No external wiring is allowed to be run through the micro panel. All wiring must be in accordance with JOHNSON CONTROL's published specifications and must be performed only by qualified JOHNSON CONTROL personnel. JOHNSON CONTROL will not be responsible for damages/problems resulting from improper connections to the controls or application of improper control signals. Failure to follow this will void the manufacturer's warranty and cause serious damage to property or injury to persons.

CHANGEABILITY OF THIS DOCUMENT

In complying with JOHNSON CONTROL's policy for continuous product improvement, the information contained in this document is subject to change without notice. While JOHNSON CONTROL makes no commitment to update or provide current information automatically to the manual owner, that information, if applicable, can be obtained by contacting the nearest JOHNSON CONTROL Applied Systems Service office.

It is the responsibility of operating/service personnel to verify the applicability of these documents to the equipment in question. If there is any question in the mind of operating/service personnel as to the applicability of these documents, then prior to working on the equipment, they should verify with the owner whether the equipment has been modified and if current literature is available.

NOMENCLATURE

BASE MODEL NUMBER

YPAL050-061

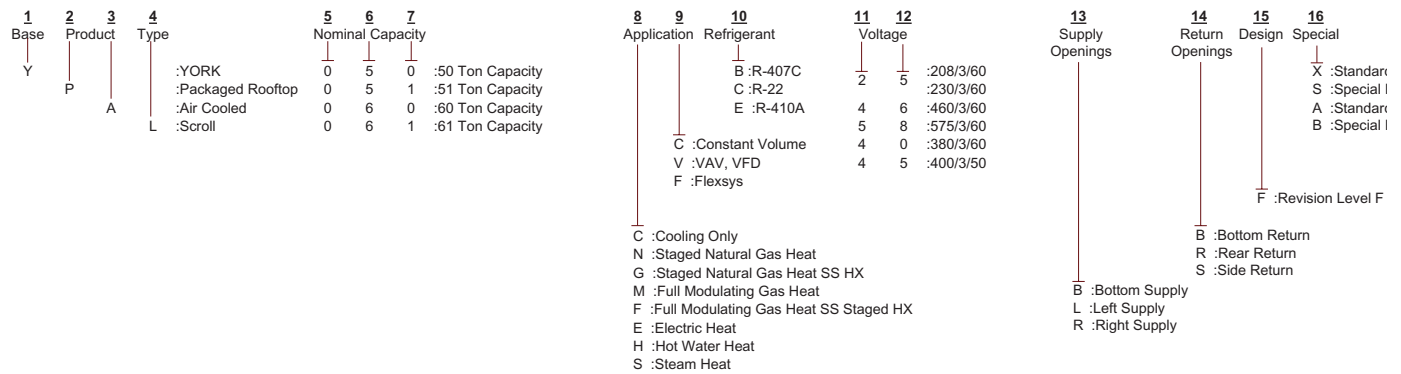

LD13270

TABLE OF CONTENTS

GENERAL SAFETY GUIDELINES.....	2
SAFETY SYMBOLS.....	2
NOMENCLATURE	3
CHANGEABILITY OF THIS DOCUMENT	3
QUICK START GUIDE – YPAL UNITS.....	5
ALL UNITS.....	6
OCCUPIED / UNOCCUPIED – HARD WIRED	6
OCCUPIED / UNOCCUPIED – INTERNAL TIME CLOCK	6
OCCUPIED / UNOCCUPIED – BAS SYSTEM	6
CONSTANT VOLUME UNITS.....	7
THERMOSTAT CONTROL - COOLING.....	7
THERMOSTAT CONTROL – HEATING.....	7
ZONE SENSOR CONTROL - COOLING	7
ZONE SENSOR CONTROL – HEATING	8
COMMUNICATED ZONE TEMP - COOLING	8
COMMUNICATED ZONE TEMP – HEATING	9
VAV UNITS.....	10
HARD WIRED SUPPLY AIR TEMPERATURE RESET - COOLING	10
OUTDOOR AIR TEMPERATURE RESET - COOLING	11
RETURN AIR TEMPERATURE RESET - COOLING.....	12
SUPPLY FAN SPEED TEMPERATURE RESET - COOLING	13
VAV HEATING	14
FLEXSYS	15
FLEXSYS HEATING.....	17
OPTIONS	18
ECONOMIZER.....	18
VENTILATION	18
EXHAUST.....	18
SMOKE PURGE	19
SUPPLY AIR TEMPERING.....	19
TRANSDUCERS – SUCTION	20
HIGH DISCHARGE PRESSURE UNLOADING.....	20
SYSTEM STABILITY CHECK	20
MORNING WARM UP	20
ADAPTIVE MORNING WARM UP	20
EMERGENCY SHUTDOWN.....	21
ALARM OUTPUTS.....	21
APPENDIX 1	22
PASSWORD	22
FIG. 1 – USER INTERFACE CONTROL PANEL	22
NAVIGATION	23
FIG. 2 – FIELD CONTROL WIRING - INPUTS	25
FIG. 3 – FIELD CONTROL WIRING - OUTPUTS	26
FIG. 4 – ATMOSPHERIC SENSOR PROBE.....	27

TABLE OF CONTENTS (CON'T)

APPENDIX 2 - FACTORY RUN TEST PROCEDURE	28
1. HIGH POST TEST.	28
2. SUPPLY FAN TEST.	29
3. RETURN FAN TEST	29
4. EXHAUST FAN, EXHAUST DAMPER TEST.....	30
5. CONDENSER FAN TEST.....	30
6. COMPRESSOR SYSTEM TEST	31
7. DAMPER TEST	32
8. STAGED ELECTRIC HEAT TEST.....	33
9. STAGED GAS HEAT TEST.....	34
10. MODULATING GAS HEAT.....	35

QUICK START GUIDE – YPAL UNITS

This quick-start guide indicates required field wiring, miscellaneous connections, and minimum programming to provide proper unit operation. This guide does not include required basic installation practices discussed in the Installation, Operation, and Maintenance manual (Form 100.50-NOM5, 50 -61 Ton, Mod F). The IOM should be reviewed to ensure all proper procedures and safety precautions are followed when installing this equipment.

In addition, any system alarms indicated by the User Interface should be diagnosed as referenced in the Installation, Operation, and Maintenance manual - refer to the Fault Description Table, located in the Service section of that manual.

This Quick Start-up Guide is indexed according to unit type and options. Units are categorized as either Constant Volume by type of control (thermostat, zone sensor, or communicated zone sensor); Variable Air Volume (VAV) by type of supply air reset (hard wired, outdoor air temperature, return air temperature, or supply fan speed); or FlexSys. Refer to applicable section for required field wiring, miscellaneous connections, and programming.

References to “Programming” indicates the setpoints that should be programmed/verified, under the respective key on the User Interface keypad (Setpoint, Program Options, Date/Time, and Schedule Keys).

Unit options should be programmed based on the unit configuration as supplied by the factory.

Refer to Appendix 1 for Installation and Programming information before using this quick-start guide.

Appendix 2 outlines the sequence of operation of the Factory Run Test feature of the control. The unit software, as shipped from the factory, contains the Factory Run Test program. The Factory Run Test feature is used by the factory to verify proper operation of the unit. However, this feature can also be used in the field during start up. By running the program you can easily determine that all the key electrical components of the unit are working properly. See Appendix 2 for directions on how to turn on the Factory Run Test feature as well as a description of the operation of the test sequence.

* FlexSys VAV is YORK’s VAV Underfloor Air Unit.

ALL UNITS

OCCUPIED / UNOCCUPIED – HARD WIRED

Field Wiring

Field-supplied contacts connected to terminals 3 (24V) & 5 (OCC) of terminal block CTB1.

Closure of the contact puts the unit into the occupied mode.



The 24 VAC switch voltage must be sourced from terminals 1 or 3 (24V) of terminal block CTB1. Use of another power source external to the unit may cause equipment damage

Misc. Connections

No Additional connections required

Programming

SCHEDULE KEY

- CLOCK SCHEDULE = USER DISABLED

OCCUPIED / UNOCCUPIED – INTERNAL TIME CLOCK

Field Wiring

No connection between terminals 2 (24V) & 5 (OCC) of terminal block CTB1.

Misc. Connections

No Additional connections required

Programming

SCHEDULE KEY

- CLOCK SCHEDULE = USER ENABLED
- Program the start and stop times for each day

OCCUPIED / UNOCCUPIED – BAS SYSTEM

Field Wiring

No connection between terminals 2 (24V) & 5 (OCC) of terminal block CTB1.

Hard wire BAS system to Primary Unit Controller

Misc. Connections

No Additional connections required

Programming

SCHEDULE KEY

- CLOCK SCHEDULE = USER DISABLED
- Program the start and stop times for each day into the BAS system.

CONSTANT VOLUME UNITS

THERMOSTAT CONTROL - COOLING

Field Wiring

Connect thermostat wiring to CTB1 located inside the control panel (See Appendix 1)

Misc. Connections

No Additional connections required

Programming

Options Key – Unit Data Subsection

- UNIT TYPE = CONSTANT VOLUME
- UNIT SIZE = 50, 51, 60, 61
- REFRIGERANT TYPE = 410A
- CONTROL METHOD = STAGED

Setpoints Key – Cooling Subsection

- 1st STAGE COOLING SETPOINT = 55.0 – 60.0° F
- 2nd STAGE COOLING SETPOINT = 50.0 – 60.0° F
- MECH COOLING LOCKOUT TEMP = 0.0 – 70.0° F

DATE / TIME

- Enter Correct Date and Time

THERMOSTAT CONTROL – HEATING

Field Wiring

Connect thermostat wiring to CTB1 located inside the control panel (See Appendix 1)

Misc. Connections

No Additional connections required

Programming

Options Key – Heating Subsection

- HEATING SYS TYPE = NONE, ELECTRIC, STAGED GAS, MODULATING GAS, HOT WATER/STEAM
- GAS HEAT CAPACITY = 375 MBH, 750 MBH, 1125 MBH
- ELEC HEAT CAPACITY = 40 KW, 40 KW – 200V, 80 KW, 80 KW – 200V, 100 KW, 100 KW – 200V, 120 KW, 160 KW, 200 KW, 240 KW

Setpoints Key – Heating Subsection

- 1st HEATING SETPOINT = 80.0 – 95.0° F
- 2nd HEATING SETPOINT = 95.0 – 115.0° F
- HEAT LIMIT TEMPERATURE = 100.0 – 150.0° F

Program Key Heating Subsection

- HEATING SYSTEM = USER ENABLED
- NIGHT SET BACK = USER ENABLED, USER DISABLED
- HW VALVE ACTION = DIRECT, REVERSE
 - *Only used with Hot Water and Steam Heat options.*

ZONE SENSOR CONTROL - COOLING

Field Wiring

Connect zone sensor wiring to CTB1 located inside the control panel (See Appendix 1)

- *Terminals 14 & 15 of terminal block CTB1 for zone sensor connections*



Shielded wire must be used and the shield should be terminated on one end only to terminal 16 of the CTB1 terminal block.

Misc. Connections

No Additional connections required

Programming

Options Key – Unit Data Subsection

- UNIT TYPE = CONSTANT VOLUME
- UNIT SIZE = 50, 51, 60, 61
- REFRIGERANT TYPE = 410A
- CONTROL METHOD = WIRED ZONE TEMP

Setpoints Key – Cooling Subsection

- 1st STAGE COOLING SETPOINT = 55.0 – 60.0° F
- 2nd STAGE COOLING SETPOINT = 50.0 – 60.0° F
- OCC ZONE COOLING SETPOINT – 60.0 – 85.0° F
- UNOCC ZONE COOLING SETPOINT – 60.0 – 95° F
- MECH CLG LOCKOUT TEMP – 0.0 – 70.0° F

DATE TIME

- Enter Correct Date and Time

ZONE SENSOR CONTROL – HEATING

Field Wiring

Connect zone sensor wiring to CTB1 located inside the control panel (See Appendix 1)

- *Terminals 14 & 15 of terminal block CTB1 for zone sensor connections*



Shielded wire must be used and the shield should be terminated on one end only to terminal 16 of the CTB1 terminal block.

Misc. Connections

No Additional connections required

Programming

Options Key – Heating Subsection

- HEATING SYS TYPE = NONE, ELECTRIC, STAGED GAS, MODULATING GAS, HOT WATER/STEAM.
- GAS HEAT CAPACITY = 375 MBH, 750 MBH, 1125 MBH
- ELEC HEAT CAPACITY = 40 KW, 40 KW – 200V, 80 KW, 80 KW – 200V, 100 KW, 100 KW – 200V, 120 KW, 160 KW, 200 KW, 240 KW

Setpoints Key – Heating Subsection

- 1st STAGE HEATING SETPOINT = 80.0 – 95.0° F
- 2ND STAGE HEATING SETPOINT = 95.0 – 115.0° F
- OCC ZONE HEATING SETPOINT = 45.0 – 99.0° F
- UNOCC ZONE HEATING SETPOINT = 45.0 – 99.0° F
- HEAT LIMIT TEMPERATURE = 100.0 – 150.0° F

Program Key Heating Subsection

- HEATING SYSTEM = USER ENABLED
- NIGHT SET BACK = USER ENABLED, USER DISABLED
- HW VALVE ACTION = DIRECT, REVERSE
 - *Only used with Hot Water and Steam Heat options.*

COMMUNICATED ZONE TEMP - COOLING

Field Wiring

- Hard wire BAS system to Primary Unit Controller

Misc. Connections

No Additional connections required

Programming**Options Key – Unit Data Subsection**

- UNIT TYPE = CONSTANT VOLUME
- UNIT SIZE = 50, 51, 60, 61
- REFRIGERANT TYPE = 410A
- CONTROL METHOD = COMM ZONE TEMP

Setpoints Key – Cooling Subsection

- 1st STAGE COOLING SETPOINT = 55.0 – 60.0° F
- 2nd STAGE COOLING SETPOINT = 50.0 – 60.0° F
- OCC ZONE COOLING SETPOINT – 60.0 – 85.0° F
- UNOCC ZONE COOLING SETPOINT – 60.0 – 95° F
- MECH CLG LOCKOUT TEMP – 0.0 – 70.0° F

DATE TIME

- Enter Correct Date and Time

COMMUNICATED ZONE TEMP – HEATING**Field Wiring**

- Hard wire BAS system to Primary Unit Controller

Misc. Connections

No Additional connections required

Programming**Options Key – Heating Subsection**

- HEATING SYS TYPE = NONE, ELECTRIC, STAGED GAS, MODULATING GAS, HOT WATER STEAM.
- GAS HEAT CAPACITY = 375 MBH, 750 MBH, 1125 MBH
- ELEC HEAT CAPACITY = 40 KW, 40 KW – 200V, 80 KW, 80 KW – 200V, 100 KW, 100 KW – 200V, 120 KW, 160 KW, 200 KW, 240 KW

Setpoints Key – Heating Subsection

- 1st STAGE HEATING SETPOINT = 80.0 – 95.0° F
- 2ND STAGE HEATING SETPOINT = 95.0 – 115.0° F
- OCC ZONE HEATING SETPOINT = 45.0 – 99.0° F
- UNOCC ZONE HEATING SETPOINT = 45.0 – 99.0° F
- HEAT LIMIT TEMPERATURE = 100.0 – 150.0° F

Program Key Heating Subsection

- HEATING SYSTEM = USER ENABLED, USER DISABLED
- OCCUPIED HEATING = USER ENABLED, USER DISABLED
- NIGHT SET BACK = Enabled, Disabled
- HW VALVE ACTION = DIRECT, REVERSE
 - *Only used with Hot Water and Steam Heat options.*

VAV UNITS

HARD WIRED SUPPLY AIR TEMPERATURE RESET - COOLING

Field Wiring

- Connect 0 to 5 volt DC input to terminal 23 (SAT +) and 24 (SAT -) or a 5K or 10K Potentiometer to terminal 22 (+5V), terminal 23 (SAT+) and 24 (SAT-) (See Appendix 1)
- For Supply Fan Hardwired Duct Static Reset connect 0 to 5 volt DC input to terminal 26 (DSP+) and 27 (DSP-) or a 5K or 10K Potentiometer to terminal 25 (+5V), terminal 26 (DSP+) and 27 (DSP-) (See Appendix 1)
- For Unoccupied cooling operation connect zone sensor wiring to CTB1 located inside the control panel (See Appendix 1)
 - *Terminals 14 & 15 of terminal block CTB1 for zone sensor connections*



Shielded wire must be used and the shield should be terminated on one end only to terminal 16 of the CTB1 terminal block.

Misc. Connections

Pneumatic tubing must be field-supplied and installed from the duct static transducer “high” side connection to a field supplied static pressure probe that is installed approximately two-thirds down the trunk line in the duct work. The duct static transducer is mounted in the control compartment.

An atmospheric static pressure probe with a bracket is factory supplied (shipped in the return section of the unit) and is to be installed on the specified support post. (See Appendix 1) A barbed fitting is already factory installed on the support post, and should be used to connect the atmospheric probe using field supplied pneumatic tubing.



The black cap on the atmospheric sensor probe should be positioned at the top. See Appendix 1 for details on the installation of the probe.

Programming

Options Key – Unit Data Subsection

- UNIT TYPE = VARIABLE AIR VOLUM
- UNIT SIZE = 50, 51, 60, 61
- REFRIGERANT TYPE = 410A
- SAT RESET METHOD = HARDWIRED INPUT

Setpoints Key – Cooling Subsection

- SAT LOW SETPOINT = 50.0 – 60.0° F
- SAT HIGH SETPOINT = 55.0 – 70.0° F
- UNOCC ZONE COOLING SETPOINT = 60.0 – 95.0° F
- RAT COOLING SETPOINT = RAT HEATING SETPOINT + 2.0° F to RAT SETPOINT FOR HIGH SAT
- MECH CLG LOCKOUT TEMP – 0.0 – 70.0° F

Setpoints Key – Supply System Subsection

- DUCT STATIC RESET LOW SETP = 0 INWG – Span
- DUCT STATIC RESET HIGH SETP = 0 INWG – Span
- DUCT STATIC OVER PRESSURE = 0 INWG - Span
- DUCT PRESSURE TRANSDUCER SPAN = 1.25, 2.5, 5.0 INWG

Program key – Compressor Systems Subsection

- PUMPDOWN – USER ENABLED, USER DISABLED

DATE TIME

- Enter Correct Date and Time

OUTDOOR AIR TEMPERATURE RESET - COOLING

Field Wiring

- For Supply Fan Hardwired Duct Static Reset connect 0 to 5 volt DC input to terminal 26 (DSP+) and 27 (DSP-) or a 5K or 10K Potentiometer to terminal 25 (+5V), terminal 26 (DSP+) and 27 (DSP-) (See Appendix 1)
- For Unoccupied cooling operation connect zone sensor wiring to CTB1 located inside the control panel (See Appendix 1)
 - *Terminals 14 & 15 of terminal block CTB1 for zone sensor connections*

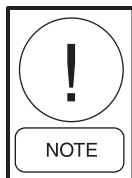

Shielded wire must be used and the shield should be terminated on one end only to terminal 16 of the CTB1 terminal block.

Misc. Connections

Pneumatic tubing must be field-supplied and installed from the duct static transducer “high” side connection to a field supplied static pressure probe that is installed approximately two-thirds down the trunk line in the duct work. The duct static transducer is mounted in the control compartment.

An atmospheric static pressure probe with a bracket is factory supplied (shipped in the return section of the unit) and is to be installed on the specified support post. (See Appendix 1) A barbed fitting is already factory installed on the support post, and should be used to connect the atmospheric probe using field supplied pneumatic tubing.

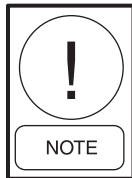

The black cap on the atmospheric sensor probe should be positioned at the top. See Appendix 1 for details on the installation of the probe.

Programming

Options Key – Unit Data Subsection

- UNIT TYPE = VARIABLE AIR VOLUM
- UNIT SIZE = 50, 51, 60, 61
- REFRIGERANT TYPE = 410A
- SAT RESET METHOD = OUTSIDE AIR

Setpoints Key – Cooling Subsection

- SAT LOW SETPOINT = 50.0 – 60.0° F
- SAT HIGH SETPOINT = 55.0 – 70.0° F
- UNOCC ZONE COOLING SETPOINT = 60.0 – 95.0° F
- RAT COOLING SETPOINT = RAT HEATING SETPOINT + 2.0° F to RAT SETPOINT FOR HIGH SAT
- OAT SETPOINT FOR LOW SAT = 70.0 – 90.0° F
- OAT SETPOINT FOR HIGH SAT = 60.0 – 80.0° F
- MECH CLG LOCKOUT TEMP – 0.0 – 70.0° F

Setpoints Key – Supply System Subsection

- DUCT STATIC RESET LOW SETP = 0 INWG – Span
- DUCT STATIC RESET HIGH SETP = 0 INWG – Span
- DUCT STATIC OVER PRESSURE = 0 INWG - Span
- DUCT PRESSURE TRANSDUCER SPAN = 1.25, 2.5, 5.0 INWG

DATE TIME

- Enter Correct Date and Time

RETURN AIR TEMPERATURE RESET - COOLING

Field Wiring

- For Supply Fan Hardwired Duct Static Reset connect 0 to 5 volt DC input to terminal 26 (DSP+) and 27 (DSP-) or a 5K or 10K Potentiometer to terminal 25 (+5V), terminal 26 (DSP+) and 27 (DSP-) (See Appendix 1)
- For Unoccupied cooling operation connect zone sensor wiring to CTB1 located inside the control panel (See Appendix 1)
 - Terminals 14 & 15 of terminal block CTB1 for zone sensor connections



Shielded wire must be used and the shield should be terminated on one end only to terminal 16 of the CTB1 terminal block.

Misc. Connections

Pneumatic tubing must be field-supplied and installed from the duct static transducer “high” side connection to a field supplied static pressure probe that is installed approximately two-thirds down the trunk line in the duct work. The duct static transducer is mounted in the control compartment.

An atmospheric static pressure probe with a bracket is factory supplied (shipped in the return section of the unit) and is to be installed on the specified support post. (See Appendix 1) A barbed fitting is already factory installed on the support post, and should be used to connect the atmospheric probe using field supplied pneumatic tubing.



The black cap on the atmospheric sensor probe should be positioned at the top. See Appendix 1 for details on the installation of the probe.

Programming

Options Key – Unit Data Subsection

- UNIT TYPE = VARIABLE AIR VOLUM
- UNIT SIZE = 50, 51, 60, 61
- REFRIGERANT TYPE = 410A
- SAT RESET METHOD = RETURN AIR

Setpoints Key – Cooling Subsection

- SAT LOW SETPOINT = 50.0 – 60.0° F
- SAT HIGH SETPOINT = 55.0 – 70.0° F
- UNOCC ZONE COOLING SETPOINT = 60.0 – 95.0° F
- RAT COOLING SETPOINT = RAT HEATING SETPOINT + 2.00° F to RAT SETPOINT FOR HIGH SAT
- RAT SETPOINT FOR LOW SAT = 75.0 – 85.0° F
- RAT SETPOINT FOR HIGH SAT = 65.0 – 75.0° F
- MECH CLG LOCKOUT TEMP – 0.0 – 70.0° F

Setpoints Key – Supply System Subsection

- DUCT STATIC RESET LOW SETP = 0 INWG – Span
- DUCT STATIC RESET HIGH SETP = 0 INWG – Span
- DUCT STATIC OVER PRESSURE = 0 INWG - Span
- DUCT PRESSURE TRANSDUCER SPAN = 1.25, 2.5, 5.0 INWG

DATE TIME

- Enter Correct Date and Time

SUPPLY FAN SPEED TEMPERATURE RESET - COOLING

Field Wiring

- For Supply Fan Hardwired Duct Static Reset connect 0 to 5 volt DC input to terminal 26 (DSP+) and 27 (DSP-) or a 5K or 10K Potentiometer to terminal 25 (+5V), terminal 26 (DSP+) and 27 (DSP-) (See Appendix 1)
- For Unoccupied cooling operation connect zone sensor wiring to CTB1 located inside the control panel (See Appendix 1)
 - *Terminals 14 & 15 of terminal block CTB1 for zone sensor connections*

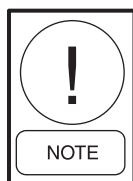

Shielded wire must be used and the shield should be terminated on one end only to terminal 16 of the CTB1 terminal block.

Misc. Connections

Pneumatic tubing must be field-supplied and installed from the duct static transducer “high” side connection to a field supplied static pressure probe that is installed approximately two-thirds down the trunk line in the duct work. The duct static transducer is mounted in the control compartment.

An atmospheric static pressure probe with a bracket is factory supplied (shipped in the return section of the unit) and is to be installed on the specified support post. (See Appendix 1) A barbed fitting is already factory installed on the support post, and should be used to connect the atmospheric probe using field supplied pneumatic tubing.

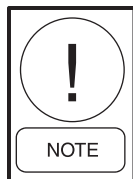

The black cap on the atmospheric sensor probe should be positioned at the top. See Appendix 1 for details on the installation of the probe.

Programming

Options Key – Unit Data Subsection

- UNIT TYPE = VARIABLE AIR VOLUM
- UNIT SIZE = 50, 51, 60, 61
- REFRIGERANT TYPE = 410A
- SAT RESET METHOD = SUPPLY FAN SPEED

Setpoints Key – Cooling Subsection

- SAT LOW SETPOINT = 50.0 – 60.0° F
- SAT HIGH SETPOINT = 55.0 – 70.0° F
- UNOCC ZONE COOLING SETPOINT = 60.0 – 95.0° F
- RAT COOLING SETPOINT = RAT HEATING SETPOINT + 2.00° F to RAT SETPOINT FOR HIGH SAT
- FAN SPEED SETP FOR LOW SAT = 70.0 – 100%
- FAN SPEED SETP FOR HIGH SAT = 50.0 – 80.0%
- MECH CLG LOCKOUT TEMP – 0.0 – 70.0° F

Setpoints Key – Supply System Subsection

- DUCT STATIC RESET LOW SETP = 0 INWG – Span
- DUCT STATIC RESET HIGH SETP = 0 INWG – Span
- DUCT STATIC OVER PRESSURE = 0 INWG - Span
- DUCT PRESSURE TRANSDUCER SPAN = 1.25, 2.5, 5.0 INWG

DATE TIME

- Enter Correct Date and Time

VAV HEATING

Field Wiring

- For Supply Fan Hardwired Duct Static Reset connect 0 to 5 volt DC input to terminal 26 (DSP+) and 27 (DSP-) or a 5K or 10K Potentiometer to terminal 25 (+5V), terminal 26 (DSP+) and 27 (DSP-). (See Appendix 1).
- For Unoccupied heating operation connect zone sensor wiring to CTB1 located inside the control panel. (See Appendix 1).
 - *Terminals 14 & 15 of terminal block CTB1 for zone sensor connections*



Shielded wire must be used and the shield should be terminated on one end only to terminal 16 of the CTB1 terminal block.

Misc. Connections

Pneumatic tubing must be field-supplied and installed from the duct static transducer “high” side connection to a field supplied static pressure probe that is installed approximately two-thirds down the trunk line in the duct work. The duct static transducer is mounted in the return air compartment. On the 106 to 130 ton unit the duct static transducer is mounted in the control compartment.

An atmospheric static pressure probe with a bracket is factory supplied (shipped in the return section of the unit) and is to be installed on the specified support post. (See Appendix 1) A barbed fitting is already factory installed on the support post, and should be used to connect the atmospheric probe using field supplied pneumatic tubing.

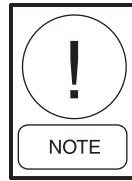

The black cap on the atmospheric sensor probe should be positioned at the top. See Appendix 1 for details on the installation of the probe.

Programming

Options Key – Heating Subsection

- HEATING SYS TYPE = NONE, ELECTRIC, STAGED GAS, MODULATING GAS, HOT WATER/STEAM.
- GAS HEAT CAPACITY = 375 MBH, 750 MBH, 1125 MBH
- ELEC HEAT CAPACITY = 40 KW, 40 KW – 200V, 80 KW, 80 KW – 200V, 100 KW, 100 KW – 200V, 120 KW, 160 KW, 200 KW, 240 KW

Setpoints Key – Heating Subsection

- HEATING SAT = 80.0 – 115.0° F
- UNOCC ZONE HEATING SETPOINT = 45.0 – 99.0° F
- HEAT LIMIT TEMPERATURE = 100.0 – 150.0° F
- RAT HEATING SETPOINT = 55.5° F – RAT COOLING SETPOINT -2° F

Program Key Heating Subsection

- HEATING SYSTEM = USER ENABLED
- NIGHT SET BACK = USER ENABLED, USER DISABLED
- HW VALVE ACTION = DIRECT, REVERSE

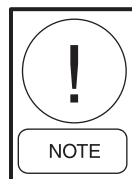

Only used with Hot Water and Steam Heat options

FLEXSYS

Field Wiring

- For Supply Fan Hardwired Duct Static Reset connect 0 to 5 volt DC input to terminal 26 (DSP+) and 27 (DSP-) or a 5K or 10K Potentiometer to terminal 25 (+5V), terminal 26 (DSP+) and 27 (DSP-) (See Appendix 1)
- Connect the FlexSys Slab Temp Sensor wiring to CTB1 located inside the control panel (See Appendix 1)
 - *Terminals 17 & 18 of terminal block CTB1 for FlexSys Slab Temp connections*



Shielded wire must be used and the shield should be terminated on one end only to terminal 16 of the CTB1 terminal block.

- Connect the FlexSys Underfloor Relative Humidity Sensor wiring to CTB1 terminal 20 (URH+) and terminal 21 (URH-)
- Connect the bypass damper to the unit wiring at the bypass opening in the unit.
- The FlexSys Underfloor Relative Humidity Sensor is field supplied. In addition to two wires which transmit the 0 to 5 volt DC signal from the sensor to the Unit Controller, the Underfloor Relative Humidity Sensor will also need to be powered. The type of voltage required to power the sensor will depend on the sensor selected. If the sensor uses 24 VAC additional wires will need to be run to terminal 1 (24 VAC) and terminal 2 (24 VAC COM) of the CTB1 terminal block. If the sensor required a different power source than 24 VAC it will need to be field supplied.

Misc. Connections

Pneumatic tubing must be field-supplied and installed from the duct static transducer “high” side connection to a field supplied static pressure probe that is installed approximately two-thirds down the trunk line in the duct work. The duct static transducer is mounted in the control compartment.

An atmospheric static pressure probe with a bracket is factory supplied (shipped in the return section of the unit) and is to be installed on the specified support post. (See Appendix 1) A barbed fitting is already factory installed on the support post, and should be used to connect the atmospheric probe using field supplied pneumatic tubing.

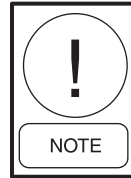

The black cap on the atmospheric sensor probe should be positioned at the top. See Appendix 1 for details on the installation of the probe.

Programming

Options Key – Unit Data Subsection

- UNIT TYPE = FLEXSYS
- UNIT SIZE = 50, 51, 60, 61
- REFRIGERANT TYPE = 410A

Setpoints Key – Cooling Subsection

- MX SUPPLY AIR TEMP = 50.0 – 75.0⁰ F
- EVAP LEAVING AIR TEMP HIGH = 50.0 – 60.0⁰ F
- EVAP LEAVING AIR TEMP LOW = 50.0 – 60.0⁰ F
- MAXIMUM BYPASS = 20.0 – 40.0 %
- RAT COOLING SETPOINT = RAT HEATING SETPOINT + 2.0⁰ F to RAT SETPOINT FOR HIGH SAT
- MECH CLG LOCKOUT TEMP – 0.0 – 70.0⁰ F

Setpoints Key – Supply System Subsection

- DUCT STATIC RESET LOW SETP = 0 INWG – Span
- DUCT STATIC RESET HIGH SETP = 0 INWG – Span
- DUCT STATIC OVER PRESSURE = 0 INWG - Span
- DUCT PRESSURE TRANSDUCER SPAN = 1.25, 2.5, 5.0 INWG

Program key – Cooling Subsection

- DEW POINT RESET = USER ENABLED, USER DISABLED
- ACTIVE SLAB CONTROL = USER ENABLED, USER DISABLED

DATE TIME

- Enter Correct Date and Time

FLEXSYS HEATING

Field Wiring

- For Supply Fan Hardwired Duct Static Reset connect 0 to 5 volt DC input to terminal 26 (DSP+) and 27 (DSP-) or a 5K or 10K Potentiometer to terminal 25 (+5V), terminal 26 (DSP+) and 27 (DSP-) (See Appendix 1)
- Connect the FlexSys Slab Temp Sensor wiring to CTB1 located inside the control panel (See Appendix 1)
 - *Terminals 17 & 18 of terminal block CTB1 for FlexSys Slab Temp connections*

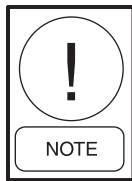

Shielded wire must be used and the shield should be terminated on one end only to terminal 16 of the CTB1 terminal block.

- Connect the FlexSys Underfloor Relative Humidity Sensor wiring to CTB1 terminal 20 (FlexSys Underfloor RH+) and terminal 21 (FlexSys Underfloor RH-)
- Connect the bypass damper to the unit wiring at the bypass opening in the unit.
- The FlexSys Underfloor Relative Humidity Sensor is field supplied. In addition to two wires which transmit the 0 to 5 volt DC signal from the sensor to the Unit Controller, the Underfloor Relative Humidity Sensor will also need to be powered. The type of voltage required to power the sensor will depend on the sensor selected. If the sensor uses 24 VAC additional wires will need to be run to terminal 1 (24 VAC) and terminal 2 (24 VAC COM) of the CTB1 terminal block. If the sensor required a different power source than 24 VAC it will need to be field supplied.

Misc. Connections

Pneumatic tubing must be field-supplied and installed from the duct static transducer “high” side connection to a field supplied static pressure probe that is installed approximately two-thirds down the trunk line in the duct work. The duct static transducer is mounted in the control compartment.

An atmospheric static pressure probe with a bracket is factory supplied (shipped in the return section of the unit) and is to be installed on the specified support post. (See Appendix 1) A barbed fitting is already factory installed on the support post, and should be used to connect the atmospheric probe using field supplied pneumatic tubing.

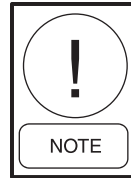

The black cap on the atmospheric sensor probe should be positioned at the top. See Appendix 1 for details on the installation of the probe.

Programming

Options Key – Heating Subsection

- HEATING SYS TYPE = NONE, ELECTRIC, STAGED GAS, MODULATING GAS, HOT WATER/STEAM.
- GAS HEAT CAPACITY = 375 MBH, 750 MBH, 1125 MBH
- ELEC HEAT CAPACITY = 40 KW, 40 KW – 200V 80 KW, 80 KW – 200V, 100 KW, 100 KW – 200V, 120 KW, 160 KW, 200 KW, 240 KW

Setpoints Key – Heating Subsection

- HEATING SAT = 80.0 – 115.0° F
- UNOCC ZONE HEATING SETPOINT = 45.0 – 99.0° F
- HEAT LIMIT TEMPERATURE = 100.0 – 150.0° F
- RAT HEATING SETPOINT = 55° F - RAT COOLING SETPOINT -2.0° F

Program Key - Heating Subsection

- HEATING SYSTEM = USER ENABLED
- NIGHT SET BACK = USER ENABLED, USER DISABLED
- HW VALVE ACTION = DIRECT, REVERSE



Only used with Hot Water and Steam Heat options

OPTIONS

ECONOMIZER

Field Wiring

No additional connections required

Misc. Connections

No additional connections required

Programming

Options Key – Economizer Subsection

- ECONO INSTALLED = NONE, DRY BULB, SINGLE ENTHALPY, DUAL ENTHALPY
- ECONO METHOD TO USE = DRY BULB, SINGLE ENTHALPY, DUAL ENTHALPY, BEST AVAILABLE

Setpoints Key – Economizer Subsection

- OUTSIDE AIR ENTHALPY SETPOINT = 22.0 – 40.0 btu/lb

Program Key – Economizer Subsection

- ECONOMIZER SYSTEM = USER ENABLED

VENTILATION

Field Wiring

No additional connections required

Misc. Connections

No additional connections required

Programming

Options Key – Ventilation Subsection

- DAMPER HARDWARE = NONE, 2 POSITION DAMPER, STANDARD, TEK AIR FULL IAQ
- VENTILATION CONTROL = FIXED MINIMUM, DEMAND

Setpoints Key – Ventilation Subsection

- OA Damper Minimum Position = 0 – 100%
- OA Damper Maximum Position = OA Damper Minimum Position – 100%

Only used for demand ventilation

- CO₂ OFFSET SETPOINT = 0 – 500 PPM

Only used for TEK AIR FULL IAQ

- MIN OA FLOW SETPOINT = 0 – Derived Span
- OUTSIDE AIR MAXIMUM FLOW = 0 – Derived Flow
- UNIT INSTALLED ALTITUDE = 0 – 10,000 Ft
- OUTSIDE AIR MINIMUM FLOW = 0 – Derived Flow

Program Key – Ventilation Subsection

- VENTILATION SYSTEM = USER ENABLED
- CONTINUOUS VENT = USER ENABLED, USER DISABLED
Only used on Constant Volume Units
- COMFORT VENTILATION = USER ENABLED, USER DISABLED
Only used on Constant Volume Units

EXHAUST

Field Wiring

No additional field wiring is required

Misc. Connections

Pneumatic tubing must be field-supplied and installed from the building static pressure transducer “high” side connection to a field supplied pressure probe installed in the conditioned space. The probe should be installed in a location where the building pressure is most critical. The building static transducer is mounted in the control compartment.

An atmospheric static pressure probe with a bracket is factory supplied (shipped in the return section of the unit) that is to be installed on the specified support post. (See Appendix 1) A barbed fitting is already factory installed on the support post, and should be used to connect the atmospheric probe using field supplied pneumatic tubing.

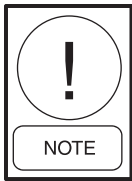

The large opening on the atmospheric sensor probe should be positioned at the bottom.

Programming

Options Key – Exhaust Subsection

- POWER EXHAUST TYPE = NONE, ON – OFF DAMPER CTRL, ON – OFF PRESS CNTRL, MODULATE DAMPER - VFD, RETURN FAN W/ EXH, RET FAN W/O EXH

Setpoints Key – Exhaust Subsection

- BUILDING PRESSURE ACTIVE SETPOINT = -0.15 - +0.15 INWC
- BLDG PRESSURE CNTRL OFFSET = 0.01 – 0.15 INWC
(ON – OFF Damper Cntrl only)
- ECONO OUTPUT FOR FAN START = 0 – 100%
- ECONO OUTPUT FOR FAN STOP = 0% – ECONO OUPUT FOR FAN START
(ON – OFF Pressure Cntrl only)
- EXHAUST OUTPUT FOR FAN START = 0 – 100%
- EXHAUST OUTPUT FOR FAN STOP = 0% – EXHAUST OUTPUT FOR FAN START
- RETURN PRESSURE HIGH SETP = 0.15 - 0.45 INWC. (RETURN W/EXHAUST ONLY)

Program Key – Exhaust Subsection

- Power Exhaust = Enabled

SMOKE PURGE

Field Wiring

For Smoke Purge 1 a field supplied normally open contact must be supplied between terminal 1 or 3 (24V) of terminal block CTB1 and terminal 6 (SMK 1) of the CTB1 terminal block.

For Smoke Purge 2 a field supplied normally open contact must be supplied between terminal 1 or 3 (24V) of terminal block CTB1 and terminal 7 (SMK 2) of the CTB1 terminal block.

For Smoke Purge 3 a field supplied normally open contact must be supplied between terminal 1 or 3 (24V)

of terminal block CTB1 and terminal 8 (SMK 3) of the CTB1 terminal block.



The 24 VAC switch voltage must be sourced from terminals 1 or 3 of terminal block CTB1. Use of another power source external to the unit may cause equipment damage.



During several of the smoke purge modes the VFD goes to full speed. If the VAV boxes do not receive a commanded to open, the ductwork could become over pressurized resulting in damage.

To prevent this from occurring, the Primary Unit Controller closes a set of dry contacts when the unit is in the smoke purge mode. By connecting wires to terminals 34 and 35 an external command can be initiated to the VAV boxes. See Appendix 1 for additional information on the wiring of this feature.

Misc. Connections

No additional connections required

Programming

Options Key – Unit Data Subsection

- SMOKE PURGE SEQ 1 = PURGE, PRESSURIZATION, EVACUATION
- SMOKE PURGE SEQ 2 = PURGE, PRESSURIZATION, EVACUATION
- SMOKE PURGE SEQ 3 = PURGE, PRESSURIZATION, EVACUATION

SUPPLY AIR TEMPERING

Field Wiring

No additional connections required

Misc. Connections

No additional connections required

Programming

Program Key – Cooling Subsection

- SUP AIR TEMPERING = USER ENABLED

Program Key – Heating Subsection

- HEATING SYSTEM = USER ENABLED

Options Key – Heating Subsection

- HEATING SYS TYPE = Must be other than NONE

TRANSDUCERS – SUCTION**Field Wiring**

No additional connections required

Misc. Connections

No additional connections required

Programming**Options Key – Compressor Systems Subsection**

- PRESS TRANS PKG = NONE; SYS 1; SYS 1, 2

HIGH DISCHARGE PRESSURE UNLOADING**Field Wiring**

No additional connections required

Misc. Connections

No additional connections required

Programming**Setpoints Key – Compressor Systems subsection**

- SYSTEM UNLOADING PRESSURE = 450 – 650 PSIG

SYSTEM STABILITY CHECK**Field Wiring**

No additional connections required

Misc. Connections

No Additional connections required

Programming**Setpoints Key – Supply System Subsection**

- FAN SPEED INSTABILITY TIME = 15 – 300 Sec
- FAN SPEED INSTABILITY LIMIT = 10 – 50 %

Program Key – Supply System Subsection

- INSTABILITY MONITOR = USER ENABLED

MORNING WARM UP**Field Wiring**

Field-supplied contacts connected to terminals 1 or 3 (24V) & 12 (W1) of terminal block CTB1.



The 24 VAC switch voltage must be sourced from terminals 1 or 3 of terminal block CTB1. Use of another power source external to the unit may cause equipment damage

Misc. Connections

No additional connections required.

Programming**Program Key – Heating Subsection**

- MORN WARM UP = USER ENABLED

ADAPTIVE MORNING WARM UP**Field Wiring**

No additional connections required

Misc. Connections

No additional connections required

Programming**Setpoints Key – Heating Subsection**

- RAT HEATING SETPOINT = 50.0 – 85.0° F
- MORNING WARM UP MAX TIME = 0 – 240 Min

Program Key – Heating Subsection

- MORN WARM UP = USER ENABLED
- ADAPT MORN WARM UP – USER ENABLED

EMERGENCY SHUTDOWN

Field Wiring

Remove the factory supplied jumper between terminals 3 and 4 of the CTB1 terminal block and connect a field-supplied normally open contacts connected to terminals 1 or 3 (24V) & 4 (SD) of terminal block CTB1. Contact must be closed for operation and open for shut down.



The 24 VAC switch voltage must be sourced from terminals 1 or 3 of terminal block CTB1. Use of another power source external to the unit may cause equipment damage

Misc. Connections

No Additional connections required

Programming

No programming is required

ALARM OUTPUTS

Field Wiring

The Primary Unit Controller has the ability to close three sets of dry contacts as a means for the customer to identify the presents of a fault. In order to identify a Supply Fan Fault connect wires to terminals 28 and 29 of the CTB1 terminal block. In order to identify a Cooling / Heating Fault connect wires to terminals 30 and 31 of the CRB 1 terminal block. In order to identify a Sensor / Misc. Fault connect wires to terminals 32 and 33 of terminal block CTB1. See Appendix 1 for additional wiring details and options.

Misc. Connections

No Additional connections required

Programming

No programming is required

APPENDIX 1 USER INTERFACE HOW TO PROGRAM USER INTERFACE

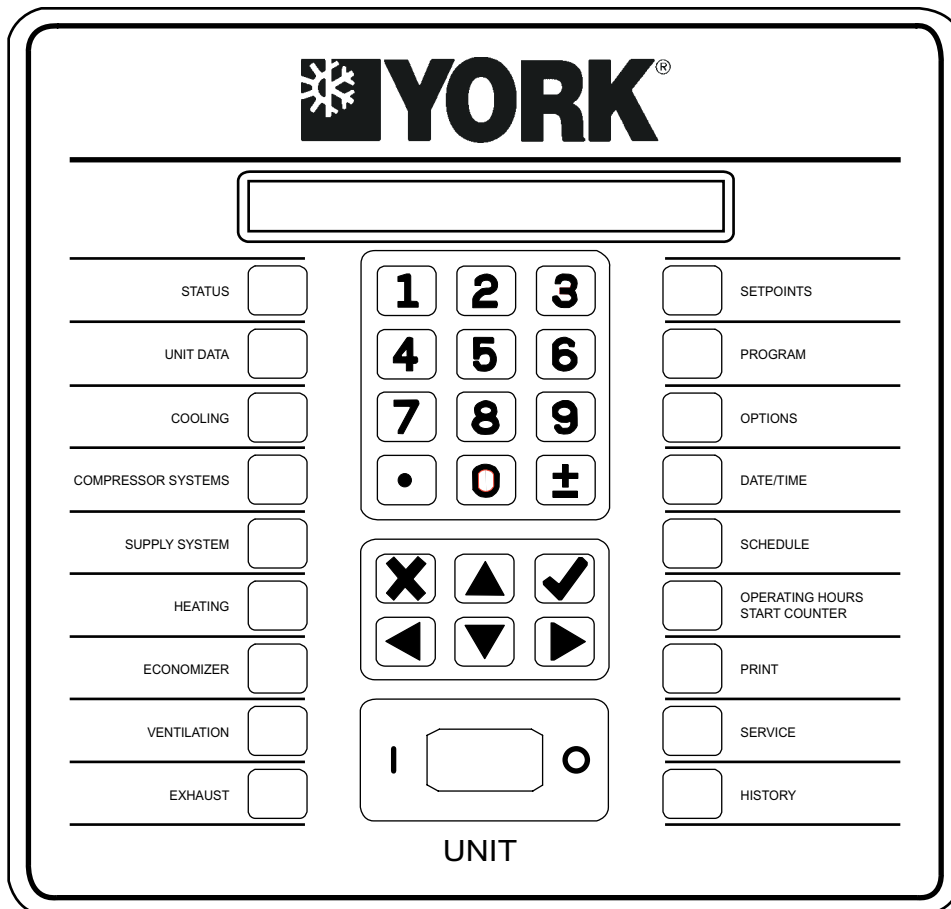

LD010669

FIG. 1 – USER INTERFACE CONTROL PANEL

PASSWORD

Passwords are used to allow restricted access to the modification of certain parameters using the “Setpoints”, “Program”, or “Options” menu keys. Each parameter is associated with a level of access. Each level of access is associated with a specific password. The access levels available are: Level 1 or Level 2.

- If a parameter is tagged as Level 1, password of 9675 must be entered in order to change the value
- If a parameter is tagged as Level 2, a password of 9725 must be entered in order to change the value. Entering the Level 2 password will also allow the changing of a Level 1 parameter.

Pressing “Setpoints”, “Program”, or “Options” key will take the user to the Login Prompt. When the user is first presented with the Login Prompt, the password field will be blank. If the user wishes to change Level 1 or Level 2 parameters, the user must know the appropriate password. At that point only the parameters changeable under the specific password level will be displayed. For example, if the user presses the Options menu key, and then enters a Level 1 password, the user will be presented with a list of option parameters that have been tagged as Level 1.

The password is entered by pressing the correct sequence of numerical keys (the 0 key through the 9 key), then pressing the ✓ key. As digits are entered, asterisks will be placed in the password field. Once entered, the menu system will compare the password to a list of stored passwords. If the entered password matches one of the stored passwords, the user is allowed access at the specified level, and the display will show the first applicable parameter of the menu list, with the appropriate edit prompts. If the password is not correct, the screen will display “Password Incorrect” for two seconds and then revert back to the Login Prompt. Pressing the ✕ key during password entry will cancel the password entry process and take the user back to the Login Prompt.

Once a password has been accepted, reentry of that password will not be required until either the user presses any other menu key other than the keys on the right hand side of the User Interface or key activity is idle for fifteen minutes. This ensures that the menu system reverts to password protection within an acceptable timeout.

NAVIGATION

The keypad allows complete control of the system from a central location. The keypad offers a multitude of commands available to access displays, program parameters, and initiate system commands. The keypad consists of thirty-six keys, which are divided into three categories, Data Entry, Navigation and Menu Selection keys. A description of each of the keys is contained below.

Data Entry Keys

The Data Entry Keys provide a means to enter values for items that support edits. The keys available to support numeric input are the 0 through 9 keys, the

decimal key, the +/- key, the ✕ key and the ✓ key. The keys available to support choice input are the ◀ key, the ▶ key, the ✕ key, and the ✓ key. **Once editing has started, the user must press either the ✓ key or the ✕ key.** Any other key press will result in the “Press ✓ or ✕ to Exit” message displayed for two seconds. If you try to edit an item that is view only, it will be ignored by the menu system.

When a numeric value that can be modified is displayed under the “Setpoints” menu key, the Default, High, and Low prompt will be shown in the upper right portion of the display. Pressing the +/- key, the decimal key, or any of the 0 through 9 keys will activate the edit mode and a request for the proper password will be made. After the proper password is entered, the cursor will be shown at the digit to be changed. After the desired numeric value has been entered, press the ✓ key to save the new value and exit the edit mode. Pressing the ◀ key will fill in the default value. Edits will only be accepted when followed by pressing the ✓ key. Pressing the ✕ key while in the edit mode will cancel the edit mode and leave the value unchanged. If an out of range value is entered, the Default, High and Low prompt is replaced by the “Out of Range” message for two seconds.

When a choice value that can be modified is displayed under the “Program” or “Options” menu key, the ◀ ▶ prompt will be shown to the left of the present choice. The ◀ key or the ▶ key will allow the different choices to be viewed, and pressing either one will activate the edit mode and a request for the proper password will be made. See Password Section of this manual for the proper procedure for entering the password. When the desired choice is displayed, press the ✓ key to save the new value and exit the edit mode. Pressing the ✕ key while in the edit mode will cancel the edit mode and leave the value unchanged.

Navigation Keys

The Navigation Keys provide a means to browse items within a menu. The keys currently available to support navigation are the Menu Select keys, the ▲ key, the ▼ key, the ◀ key, and the ▶ key.

Pressing a Menu Select key brings the user to the first screen under that menu. The screens within each menu are arranged in a circular list. The user may browse through the screens using the ▲ key and the ▼ key. Pressing the ▼ key will advance through the screens in order from top to bottom until the bottom screen has been reached. When the bottom screen is displayed, pressing the ▼ key will wrap the display to the top screen of the menu. Pressing the ▲ key will move through the screens in order from bottom to top until the top screen has been reached. When top screen is displayed, pressing the ▲ key will wrap the display to the bottom screen of the menu. Once either the ▲ key or the key ▼ is pressed, pressing any Menu Select key will bring the user to the first screen under that menu (even if it is the same menu being viewed).

Navigation through the circular list of items can also be achieved by repeated presses of the same Menu Select key, as long as no other keys are pressed. For example, pressing the UNIT DATA key three times will bring the user to the third screen of the UNIT DATA menu; pressing the UNIT DATA key once, then pressing the ▼ key, then pressing the Unit Data key again will bring the user to the first screen of the UNIT DATA menu.

The ◀ key and the ▶ key are used to scroll “sideways” between the same displays for each system. For example, when viewing the Sys 1 Pressures under the COMPRESSOR SYSTEMS key, pressing the ▶ key will scroll “sideways” to the Sys 2 Pressures display and pressing the ◀ key will scroll “sideways” to the Sys Pressures display for the last system on the unit.

When programming numeric or non-numeric values, the ▼ key and the ▲ key are used to scroll forward (down) and backward (up) through the items to be programmed or set.

Wiring Notes:

CTB1 Field Control Wiring (Inputs)

1. Wiring shown indicates typical wiring. Refer to the I.O.M. manual for more detailed wiring methods and options.
2. All wiring is Class 2, low voltage.
3. Maximum power available from the 24 VAC terminal is 40 VA.
4. Use shielded wire where shown.
5. Potentiometer application shown. As an alternative, signal inputs can be driven from an analog output of a third party controller. Note: Input load resistance is 15K ohms
6. The FlexSys Underfloor Relative Humidity Sensor is field supplied. In addition to two wires which transmit the 0 to 5 volt DC signal from the sensor to the Unit Controller, the Underfloor Relative Humidity Sensor will also need to be powered. The type of voltage required to power the sensor will depend on the sensor selected. If the sensor uses 24 VAC additional wires will need to be run to terminal 1 (24 VAC) and terminal 2 (24 VAC COM) of the CTB1 terminal block. If the sensor required a different power source than 24 VAC it will need to be field supplied.

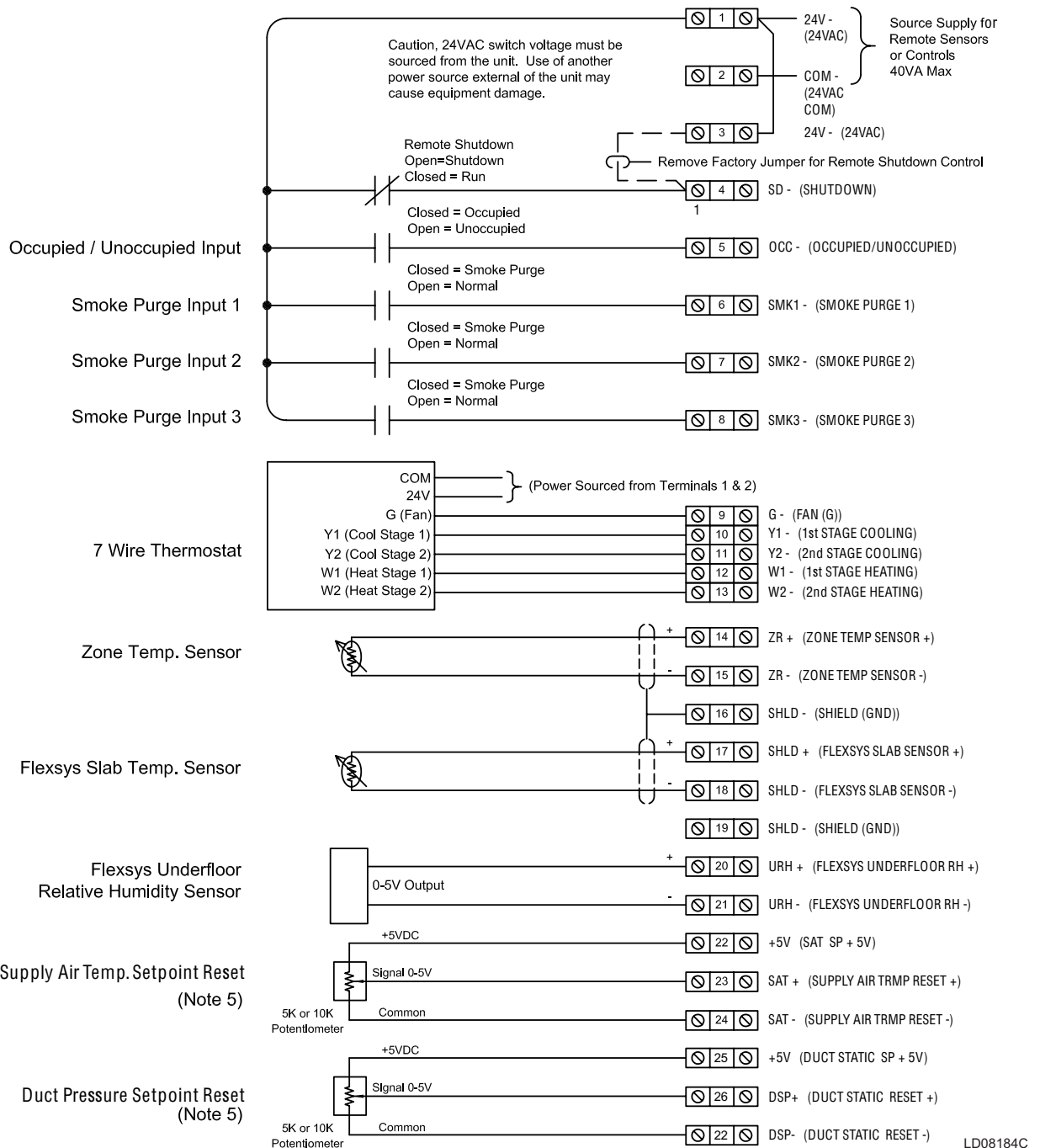

LD08184C

FIG. 2 – FIELD CONTROL WIRING - INPUTS
JOHNSON CONTROLS

CTB1 Field Control Wiring (Outputs)

Wiring Notes:

1. Wiring shown indicates typical wiring. Refer to the I.O.M. manual for more detailed wiring methods and optic
2. All wiring is Class 2, low voltage.
3. Maximum power available from the 24 VAC terminal is 40 VA.
4. Use shielded wire where shown.
5. Relay contacts suitable for pilot duty to 1A from 24VAC to 120VAC

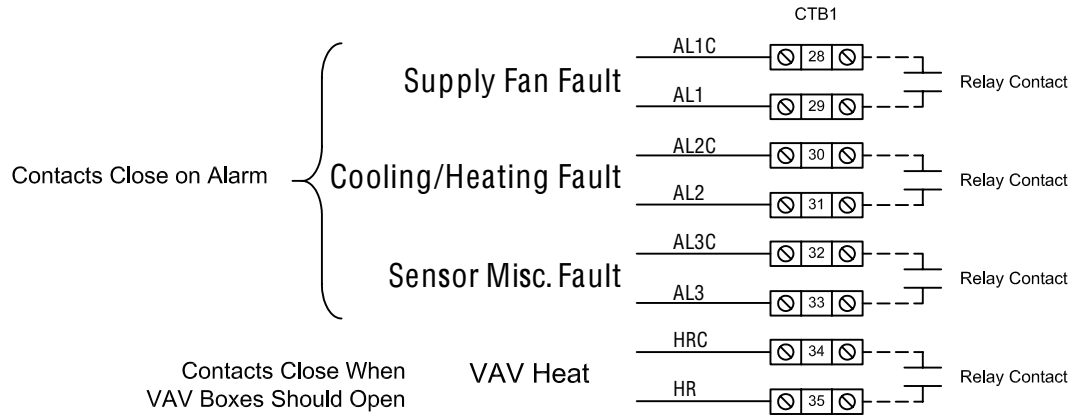

Dry Contact Application

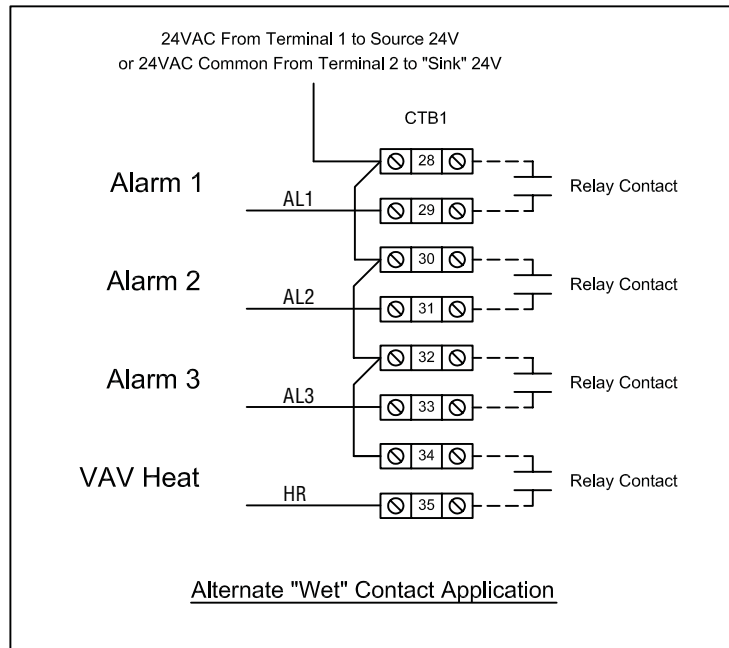

LD08186B

FIG. 3 – FIELD CONTROL WIRING - OUTPUTS

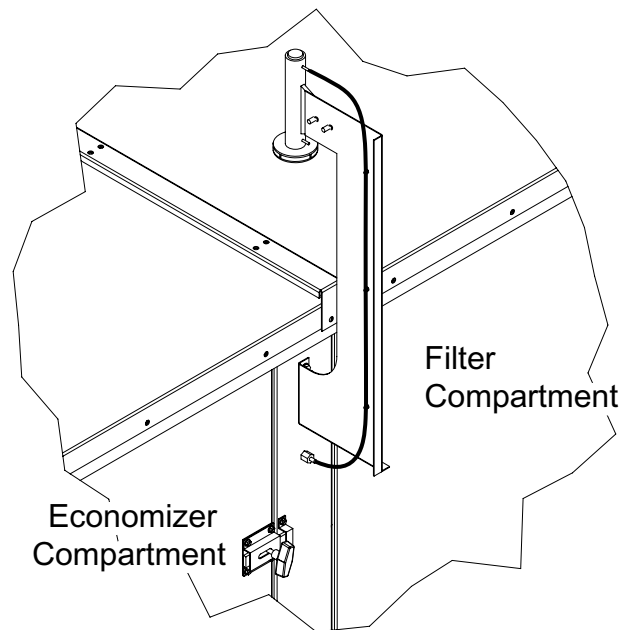

LD13127

FIG. 4 – ATMOSPHERIC SENSOR PROBE

The atmospheric probe should be mounted on the support post on the control side of the unit between the Economizer and Filter Compartment.

APPENDIX 2

FACTORY RUN TEST PROCEDURE

Each unit undergoes a final QA check before the unit is shipped from the factory. This final check includes a complete operational test that verifies the operation of all of the systems and installed options on the unit. This Run Test is built into and performed by the unit controller (IPU). This mode can also be used in the field to verify operation at start up.

The unit will arrive in the field with all the ordered options already configured. As part of start up you may

need to change set points and turn features On or OFF based on the desires of the customer. Once configured, the FACTORY RUN TEST mode can be used to verify operation. The controller will begin with the first applicable test in the order indicated in the table below. The controller will prompt you with a question “Initiate Test”. Indicate Yes by pressing the accept key (check key) or move to a different test on the list by pressing the up or down arrow keys. Pressing the cancel key will leave the RUN TEST mode.

RUN TEST ORDER	TEST DESCRIPTION	CRITERIA NECESSARY FOR TEST TO BE RUN
1	High Potential Test	All Units (FACTORY ONLY)
2	Supply Fan Test	All Units
3	Return Fan Test	Units equipped with Return Fans
4	Exhaust Fan Test	Units equipped with Exhaust Fans
5	Condenser Fan 1A Test	All Units
6	Condenser Fan 1B Test	All Units
7	Condenser Fan 2A Test	All Units
8	Condenser Fan 2B Test	All Units
9	Condenser Fan 3A Test	Unit Size is 70 Ton thru 150 Ton
10	Condenser Fan 3B Test	Unit Size is 70 Ton thru 150 Ton
11	Compressor System 1 Test	All Units
12	Compressor System 2 Test	All Units
13	Compressor System 3 Test	Unit Size is 70 Ton thru 150 Ton units
14	Damper Operation Test	All Units
15	Staged Electric Heat Test	Units with HEAT TYPE set to ELECTRIC
16	Staged Gas Heat Test	Units with HEAT TYPE set to STAGED GAS
17	Mod Gas Heat Test	Units with HEAT TYPE set to MODULATING GAS

For each test, the controller will indicate the test name and the state of the test. For the state of the test, the following information will be displayed:

- NO TEST – This message indicates that the test shown has never been performed.
- UNDERWAY – This message indicates the test shown has started.
- PASS – This message indicates the test shown was completed successfully. When started in the field all the items should show PASS
- FAIL – this message indicates the test shown has ended and was not successful.

To start the test, turn the UNIT rocker switch to the off position. Press the service key and enter password **9725**. See section 6 of the IOM for information on how to enter the PASSWORD.

Use the down arrow key to scroll down to FACTORY RUN TEST. Press the check key (✓) and use the right arrow key to change from USER DISABLED to USER ENABLED. Press the check key (✓). The following test sequences will appear:

1. The first test that appears is HIGH POST TEST. The screen should say PASS. Use the down arrow key to go to the next test.

2. SUPPLY FAN TEST

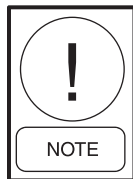

DURING THIS TEST SEQUENCE, THE SUPPLY FAN BLOWER WILL OPERATE AT 42 HERTZ. MAKE SURE THIS SPEED WILL NOT RESULT IN A STATIC PRESSURE WHICH COULD DAMAGE THE BUILDING SUPPLY DUCT SYSTEM.

To initiate the test press the check key (✓). The control will ask you ARE YOU SURE? Press the check key (✓) again.

Once underway, the controller will perform the following sequence:

- Start the Supply Fan and set the Supply Fan VFD output to 50%.
- Wait 30 Seconds
- Stop the Supply Fan

Prompt Message #1:

SPEED CORRECT? When the supply fan is running the supply fan VFD should indicate approximately 42 Hertz. Press the check key if the speed is correct.

Prompt Message #2

ROTATION CORRECT? – As the supply fan coasts down, you can open the door and verify proper rotation. Press the check key if the rotation is correct. If not, identify why the rotation is wrong, and correct.

If both messages are accepted, PASS will be indicated at the display. Use the down arrow key to move to the next test.

3. RETURN FAN TEST (If unit is configured with Return Fan)



DURING THIS TEST SEQUENCE, THE SUPPLY FAN BLOWER WILL OPERATE AT 42 HERTZ. MAKE SURE THIS SPEED WILL NOT RESULT IN A STATIC PRESSURE WHICH COULD DAMAGE THE BUILDING SUPPLY DUCT SYSTEM.

To initiate the test press the check key (✓). The control will ask you ARE YOU SURE? Press the check key (✓) again.

Once underway, the controller will perform the following sequence:

- Set the Supply Fan to ON
- Set the Supply Fan VFD to 50%
- Set the Return Fan to ON
- Set the Return Fan VFD to 50%
- Wait 30 Seconds
- Stop the Supply Fan and Return Fan.

Prompt Message #1:

SPEED CORRECT? When the return fan is running the Return Fan VFD should indicate approximately 42 Hertz. Press the check key if the speed is correct.

Prompt Message #2

ROTATION CORRECT? – As the Return Fan coasts down you can open the door and verify proper rotation. Press the check key if the rotation is correct. If not, identify why the rotation is wrong, and correct.

If both messages are accepted, PASS will be indicated at the display. Use the down arrow key to move to the next test.

4. EXHAUST FAN, EXHAUST DAMPER TEST (if unit is configured with an Exhaust Fan)

To initiate the test press the check key (✓). The control will ask you ARE YOU SURE? Press the check key (✓) again.

Once underway, the controller will perform the following sequence:

- Start the Exhaust Fan and set the Exhaust Fan VFD output to 50%.
- Set the Exhaust Damper to 50%
- Wait 30 Seconds
- Stop the Exhaust Fan

Prompt Message #1:

DAMPER/SPEED CORRECT? When the Exhaust Fan is running the Exhaust Fan VFD should indicate approximately 33 Hertz. If an exhaust damper is installed it should open to approximately 50%. Press the check key if the speed and/or the damper position is correct.

Prompt Message #2:

ROTATION CORRECT? – As the Exhaust Fan coasts down, you can open the door and verify proper rotation. Press the check key if the rotation is correct. If not, identify why the rotation is wrong, and correct.

If both messages are accepted, PASS will be indicated at the display. Use the down arrow key to move to the next test.

5. CONDENSER FAN TEST (1A, 1B, 2A, 2B)

To initiate the test press the check key (✓). The control will ask you ARE YOU SURE? Press the check key (✓) again.

Once underway, the controller will perform the following sequence:

- Set CONDENSER FAN 1A to ON
- Wait 5 seconds
- Set CONDENSER FAN 1A to OFF

Prompt Message #1:

CORRECT FAN? – Verify that the correct condenser fan has turned on. If not, determine why and correct. Press the check key (✓) if the correct fan has turned on.

Prompt Message #2:

ROTATION CORRECT? – Verify that the condenser fan rotation is correct. Press the check key (✓) if the fan is rotating in the correct direction.

If both messages are accepted, PASS will be indicated at the display. Use the down arrow key to move to the next test.

Repeat the above procedure for each of the condenser fans.

6. COMPRESSOR SYSTEM TEST (1A, 1B, 2A, 2B).

To initiate the test press the check key (✓). The control will ask you ARE YOU SURE? Press the check key (✓) again.

Once underway, the controller will perform the following sequence:

- Set COMPRESSOR 1A to ON
- Wait 5 Seconds
- Turn COMPRESSOR 1A to OFF

Prompt Message #1:

ROTATION CORRECT FOR 1A? – To verify proper rotation you need to attach a gauge set to the compressor system prior to conducting the test. If rotation is correct, the discharge pressure should increase rapidly. If the discharge and suction pressures remain the same, the rotation is not correct. Press the check key (✓) if the compressor rotation is correct.

Once accepted:

- Set COMPRESSOR 1B to ON
- Wait 5 Seconds
- Turn COMPRESSOR 1B to OFF

Prompt Message #2:

ROTATION CORRECT FOR 1B? – To verify proper rotation you need to attach a gauge set to the compressor system prior to conducting the test. If rotation is correct, the discharge pressure should increase rapidly. If the discharge and suction pressures remain the same, the rotation is not correct. Press the check key (✓) if the compressor rotation is correct.

Once accepted, the controller will perform the following sequence:

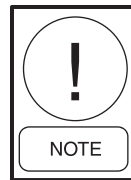

DURING THIS TEST SEQUENCE, THE SUPPLY FAN BLOWER WILL OPERATE AT 50 HERTZ. MAKE SURE THIS SPEED WILL NOT RESULT IN A STATIC PRESSURE WHICH COULD DAMAGE THE BUILDING SUPPLY DUCT SYSTEM.

- Set the SUPPLY FAN to On
- Set Supply Fan VFD AO to 60%
- Wait 30 Seconds
- Set COMPRESSOR 1A to ON
- Set the required CONDENSER FANS to ON
- Wait 30 seconds.
- Set COMPRESSOR 1B to ON
- Wait 180 seconds
- Set COMPRESSOR 1A to OFF
- Wait 10 seconds
- Set COMPRESSOR 1B to OFF

PASS will be indicated for this test and all outputs will be turned off.

Note, if at anytime during this test, the Compressor System #1 status or the Compressor System #1 LPCO status is not indicated, all outputs will be immediately turned off and FAIL will be indicated for the test.

Repeat the above procedure for each of the compressor systems.

7. DAMPER TEST

To initiate the test press the check key (✓). The control will ask you ARE YOU SURE? Press the check key (✓) again.

Once underway, the controller will perform the following sequence:

- Set the OUTSIDE AIR / RETURN DAMPER to 50%
- Set the EXHAUST DAMPER to 50%
- Wait 45 seconds

Prompt Message #1:

ALL DAMPERS OPEN 50%? Check the above dampers and verify they are approximately 50%. If they are press the ACCEPT – CHECK KEY (✓).

If the dampers operated properly, use the down arrow key to move to the next test.

8. STAGED ELECTRIC HEAT TEST

This test can be run in one of two ways. The electrical circuit could be checked without turning on the heaters by removing the fuses feeding the electric heat elements. Or if the fuses are left in place, the heater elements will be energized. If the heater elements are energized, the supply fan must be turned on or there is a possibility the limits will trip. The following procedure will turn on the supply fan:

- On constant volume units pressure the service key and use the down arrow key to navigate to the digital output (DO) SUPPLY FAN screen. Press the check key (✓) and use the right arrow key to change the OFF to ON. Press the check key (✓). The blower will start.
- In addition on VAV units use the down arrow key to navigate to the analog output (AO) SUPPLY FAN VFD screen. Press the check key (✓) and use the numerical keypad to enter 50. Press the check key (✓). The supply fan will operate at approximately 42 hertz.

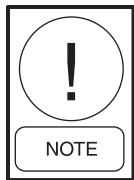

DURING THIS TEST SEQUENCE, THE SUPPLY FAN BLOWER WILL OPERATE AT 42 HERTZ. MAKE SURE THIS SPEED WILL NOT RESULT IN A STATIC PRESSURE WHICH COULD DAMAGE THE BUILDING SUPPLY DUCT SYSTEM.

Press the SERVICE KEY and use the down arrow key to navigate to the FACTORY RUN TESTER screen and reenter the run test mode. Use the down arrow key to move to the STAGE ELECTRIC HEAT TEST screen.

Once underway, the controller will perform the following sequence:

- Set HEAT STAGE OUTPUT 1 to ON

Prompt Message #1;

HEAT STAGE 1 ON? Check to verify that the contactor for HEAT STAGE 1 is on and if the fuses are installed, voltage is present at the HEAT STAGE 1 heater element. If operating properly press the check key (✓) to accept. If contactor and/or heater element did not come on determine why and correct the problem.

If an accept is not received in 60 seconds, the screen will indicate FAIL and all outputs will be homed.

Once accepted:

- Set HEAT STAGE 1 output to OFF
- Set HEAT STAGE 2 output to ON

Prompt Message #2:

HEAT STAGE 2 ON? Check to verify that the contactor for HEAT STAGE 2 is on. If the fuses are in verify voltage is present at the HEAT STAGE 2 heater element. If operating properly, press the check key (✓) to accept. If contactor and/or heater element did not come on, determine why and correct the problem.

If an accept is not received in 60 seconds, the screen will indicate FAIL and all outputs will be homed.

This will be repeated until all stages have been turned ON and Accepted. Once the last stage has been turned ON and Accepted, PASS will be indicated.

To turn off the supply fan place the UNIT rocker switch to the ON position and then back to OFF. You must reset the SUPPLY FAN VFD setting back to 0%. To do this, enter the SERVICE menu and use the down arrow key to navigate to the analog output (AO) SUPPLY FAN VFD screen. Press the check key (✓) and use the numerical keypad to enter 0. Press the check key (✓). The analog output for the supply fan will now be set back to 0.

9. STAGED GAS HEAT TEST

In order to run the gas heat test the Supply Fan must be on or the gas heat section may shut down on the temperature limit. The following procedure will turn on the Supply Fan:

- On constant volume units press the service key and use the down arrow key to navigate to the digital output (DO) SUPPLY FAN screen. Press the check key (✓) and use the right arrow key to change the OFF to ON. Press the check key (✓). The blower will start.
- In addition on VAV units use the down arrow key to navigate to the analog output (AO) SUPPLY FAN VFD screen. Press the check key (✓) and use the numerical keypad to enter 50. Press the check key (✓). The supply fan will operate at approximately 42 hertz.



DURING THIS TEST SEQUENCE, THE SUPPLY FAN BLOWER WILL OPERATE AT 42 HERTZ. MAKE SURE THIS SPEED WILL NOT RESULT IN A STATIC PRESSURE WHICH COULD DAMAGE THE BUILDING SUPPLY DUCT SYSTEM.

Press the SERVICE KEY and use the down arrow key to navigate to the FACTORY RUN TESTER screen and reenter the run test mode. Use the down arrow key to move to the STAGE GAS HEAT TEST screen. Use the check key (✓) to start the test.

During the RUN TEST, the unit controller will Start and Stop the Furnace Modules while monitoring the status circuits from the Furnace Modules. If the status indications are received correctly (correct sequence and timing) then the run test will proceed. If the status indications are not received correctly, the controller will FAIL the test.

Once underway, the controller will perform the following sequence:

- Set STG GAS FURNACE 1 LOW to ON
- Wait 10 seconds
- Wait for FURNACE 1 STATUS to be ON for 15 seconds. If the FURNACE 1 STATUS is not

ON for 15 seconds over a 130 second period, the control will terminate the test and post a FAIL message.

- Wait 5 seconds
- Set STG GAS FURNACE 1 HIGH to ON
- Wait 5 seconds.

Prompt Message #1:

FURNACE 1 ON HIGH? At this point verify that the gas heat section has gone to high fire and if so press the check key (✓). If not, then determine why and correct.

Once accepted:

- Wait 30 seconds
- Set STG GAS FURNACE 1 HIGH to OFF
- Set STG GAS FURNACE 1 LOW to OFF
- Wait 30 seconds

If the GAS HEAT CAPACITY setting is set to 375 MBH, the screen will indicate PASS. If the GAS HEAT CAPACITY setting is set to 750 MBH or 1125 MBH the control will then perform the FURNACE 1 test sequence on FURNACE 2.

If the Furnace 2 testing is successful and the GAS HEAT CAPACITY setting is set to 750 MBH, the screen will indicate PASS and turn off all the heating outputs.

If the GAS HEAT CAPACITY setting is set to 1125 MBH then, the control will perform the FURNACE 1 test sequence on Furnace 3.

If the Furnace 3 testing is successful, the screen will indicate PASS and turn off all the heating outputs.

To turn off the supply fan place the UNIT rocker switch to the ON position and then back to OFF. You must reset the SUPPLY FAN VFD setting back to 0%. To do this, enter the SERVICE menu and use the down arrow key to navigate to the analog output (AO) SUPPLY FAN VFD screen. Press the check key (✓) and use the numerical keypad to enter 0. Press the check key (✓). The analog output for the supply fan will now be set back to 0.

10. MODULATING GAS HEAT

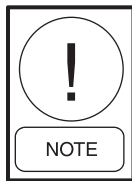

DO NOT USE THE FACTORY RUN TESTER PROGRAM TO TEST THE MODULATING GAS HEAT.

The modulating gas heat operation can be verified by “forcing” digital (DO) and analog (AO) outputs using the Service key of the User Interface. FURNACE STATUS COUNT is contained under the analog (AI) input screen. The table below gives the sequence in which the outputs should be “forced” and the expected results.

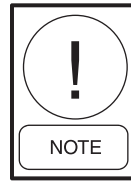

DURING THIS TEST SEQUENCE, THE SUPPLY FAN BLOWER WILL OPERATE AT 42 HERTZ. MAKE SURE THIS SPEED WILL NOT RESULT IN A STATIC PRESSURE WHICH COULD DAMAGE THE BUILDING SUPPLY DUCT SYSTEM.

OUTPUT DESCRIPTION	FORCED VALUE	EXPECTED RESULT
DO SUPPLY FAN	ON	TURN SUPPLY FAN ON
AO SUPPLY FAN VFD	50%	RUN SUPPLY FAN AT 42 HZ
AO HEATING VALVE	80%	
DO MOD GAS FURN 1B	ON	
DO MOD GAS FURN 1A LO	ON	FURNACE SECTION 1A WILL LIGHT ON HIGH FIRE
AI FURNACE STATUS COUNT		390 - 505
AO HEATING VALVE	40%	FURNACE SECTION 1A WILL REDUCE FIRING RATE
DO MOD GAS FURN 1A HI	OFF	FURNACE SECTION 1A WILL GO TO LOW FIRE
AI FURNACE STATUS COUNT		159 - 274
AO HEATING VALVE	80%	
DO MOD GAS FURN 1A HI	ON	FURNACE SECTION 1A ON HIGH FIRE
DO MOD GAS FURN 1B	ON	FURNACE SECTION 1B WILL LIGHT
AI FURNACE STATUS COUNT		2240 - 2354
DO MOD GAS FURN 1B	OFF	FURNACE SECTION 1B WILL GO OFF
DO MOD GAS FURN 1A LO	OFF	FURN SECTION 1A WILL GO OFF
DO MOD GAS FURN 1A HI	OFF	
AO HEATING VALVE	0%	
IF 750,000 HEAT OPTION (2 HEAT SECTIONS)		
DO MOD GAS FURN 2 LO	ON	FURNACE SECTION 2 LIGHTS ON LOW FIRE
AI FURNACE COUNT		506 - 621
DO MOD GAS FURN 2 HI	ON	FURNACE SECTION 2 GOES TO HIGH FIRE
DO MOD GAS FURN 2 HI	OFF	FURNACE SECTION 2 GOES TO LOW FIRE
DO MOD GAS FURN 2 LO	OFF	FURNACE SECTION 2 SHUTS DOWN
IF 115,000 HEAT OPTION (3 HEAT SECTIONS)		
DO MOD GAS FURN 3 LO	ON	FURNACE SECTION 3 LIGHTS ON LOW FIRE
AI FURNACE COUNT		968 - 1083
DO MOD GAS FURN 3 HI	ON	FURNACE SECTION 3 GOES TO HIGH FIRE
DO MOD GAS FURN 3 HI	OFF	FURNACE SECTION 3 GOES TO LOW FIRE
DO MOD GAS FURN 3 LO	OFF	FURNACE SECTION 3 SHUTS DOWN
DO SUPPLY FAN	OFF	SUPPLY TURNS OFF
AO SUPPLY FAN VFD	0%	

