



CENTRIFUGAL LIQUID CHILLERS

SERVICE INSTRUCTIONS

Supercedes 050.40-M1 (813)

Form 050.40-M1 (913)

YK, YD, YT, YR, CYK, YKEP, YMC² CHILLERS REFRIGERANT LEVEL SENSOR TROUBLESHOOTING AND REPLACEMENT



Issue Date:
September 26, 2013



IMPORTANT!

READ BEFORE PROCEEDING!

GENERAL SAFETY GUIDELINES

This equipment is a relatively complicated apparatus. During installation, operation maintenance or service, individuals may be exposed to certain components or conditions including, but not limited to: refrigerants, materials under pressure, rotating components, and both high and low voltage. Each of these items has the potential, if misused or handled improperly, to cause bodily injury or death. It is the obligation and responsibility of operating/service personnel to identify and recognize these inherent hazards, protect themselves, and proceed safely in completing their tasks. Failure to comply with any of these requirements could result in serious damage to the equipment and the property in

which it is situated, as well as severe personal injury or death to themselves and people at the site.

This document is intended for use by owner-authorized operating/service personnel. It is expected that these individuals possess independent training that will enable them to perform their assigned tasks properly and safely. It is essential that, prior to performing any task on this equipment, this individual shall have read and understood this document and any referenced materials. This individual shall also be familiar with and comply with all applicable governmental standards and regulations pertaining to the task in question.

SAFETY SYMBOLS

The following symbols are used in this document to alert the reader to specific situations:



Indicates a possible hazardous situation which will result in death or serious injury if proper care is not taken.



Identifies a hazard which could lead to damage to the machine, damage to other equipment and/or environmental pollution if proper care is not taken or instructions are not followed.



Indicates a potentially hazardous situation which will result in possible injuries or damage to equipment if proper care is not taken.

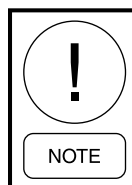

Highlights additional information useful to the technician in completing the work being performed properly.



External wiring, unless specified as an optional connection in the manufacturer's product line, is not to be connected inside the OptiView™ cabinet. Devices such as relays, switches, transducers and controls and any external wiring must not be installed inside the cabinet. All wiring must be in accordance with Johnson Controls' published specifications and must be performed only by a qualified electrician. Johnson Controls will NOT be responsible for damage/problems resulting from improper connections to the controls or application of improper control signals. Failure to follow this warning will void the manufacturer's warranty and could cause serious damage to property or personal injury.

CHANGEABILITY OF THIS DOCUMENT

In complying with Johnson Controls' policy for continuous product improvement, the information contained in this document is subject to change without notice. Johnson Controls makes no commitment to update or provide current information automatically to the manual owner. Updated manuals, if applicable, can be obtained by contacting the nearest Johnson Controls Service office or accessing the Johnson Controls QuickLIT website at <http://cgproducts.johnsoncontrols.com>.

Operating/service personnel maintain responsibility for the applicability of these documents to the equipment. If there is any question regarding the applicability of

these documents, the technician should verify whether the equipment has been modified and if current literature is available from the owner of the equipment prior to performing any work on the chiller.

CHANGE BARS

Revisions made to this document are indicated with a line along the left or right hand column in the area the revision was made. These revisions are to technical information and any other changes in spelling, grammar or formatting are not included.

THIS PAGE INTENTIONALLY LEFT BLANK.

TABLE OF CONTENTS

SECTION 1 - OVERVIEW	7
Refrigerant Level Sensor.....	7
SECTION 2 - TROUBLESHOOTING.....	11
Refrigerant Level Function Test.....	11
SECTION 3 - SENSOR REMOVAL AND INSTALLATION	19
Hansen Sensor.....	19
CS01 Sensor	19
CS02 Sensor	20
SECTION 4 - REFRIGERANT LEVEL SENSOR CALIBRATION	23
Hansen Sensor	23
CS01 Sensor	23
CS02 Sensor	25

LIST OF FIGURES

FIGURE 1 - Refrigerant Level Sensor	7
FIGURE 2 - Sensor NPT or Rotalock Connection to Condenser Shell	7
FIGURE 3 - Sensor Probe and Housing.....	7
FIGURE 4 - Hansen Probe Assembly	8
FIGURE 5 - CS01 Probe With Rod	8
FIGURE 6 - CS02 Probe Assembly.....	8
FIGURE 7 - CS01 Electrical Enclosure Threaded onto Probe Assembly.....	8
FIGURE 8 - Probe Electrical Enclosure and Signal Transmitter Board	9
FIGURE 9 - Hansen Signal Transmitter Board – With and Without Potting Compound.....	9
FIGURE 10 - CS01 Signal Transmitter Board	9
FIGURE 11 - CS02 Signal Transmitter Board	9
FIGURE 12 - CS02 Sensor Probe Mounting.....	9
FIGURE 13 - Refrigerant Level Test Flowchart	11
FIGURE 14 - Sensor Troubleshooting flowchart	12
FIGURE 15 - System Troubleshooting Flowchart.....	14
FIGURE 16 - Level Sensor Connector Wiring	17
FIGURE 17 - CS02 Probe Separated from Electrical Enclosure	20
FIGURE 18 - CS02 Phillips Screw and Wire Blade Terminal	20
FIGURE 19 - Hansen Sensor	23
FIGURE 20 - Probe Uncovered – Refrigerant at Empty Level	23
FIGURE 21 - Probe Fully Submerged – Refrigerant at Full Level.....	23
FIGURE 22 - CS01 Sensor	24
FIGURE 23 - CS02 Sensor	25
FIGURE 24 - Mode 4 – Span Resolution	27
FIGURE 25 - Mode 5 – 50% Tuning Mode.....	27
FIGURE 26 - Mode 6 – Span Shifting	28
FIGURE 27 - Mode 7 – Increase/Decrease Span from Low	29
FIGURE 28 - Mode 8 – Increase/Decrease Span from High.....	30
FIGURE 29 - Mode 9 – Increase/Decrease Span from Midpoint 50%	31
FIGURE 30 - Mode L – Linearity Tuning	32

LIST OF TABLES

TABLE 1 - Sensor Hardware and Wiring Troubleshooting.....	16
TABLE 2 - CS02 Sensor Part Numbers with Rotalock End Fittings.....	19

SECTION 1 - OVERVIEW

This manual provides an overview of the Hansen and Innovative Solutions CS01 and CS02 refrigerant level sensors currently in use in York centrifugal chillers and methods used to identify each sensor. Refrigerant level control troubleshooting procedures, sensor removal and replacement instructions, and sensor calibration instructions are also included.

Capacitive liquid level sensors are used to sense the refrigerant level in the chiller condenser of large tonnage chillers, or flash tank intercooler on two-stage models.



FIGURE 1 - REFRIGERANT LEVEL SENSOR

The refrigerant level sensor electrical signal is used by the control panel to maintain the level of refrigerant in the condenser or flash tank at a programmed setpoint.

The control panel microprocessor modulates a valve controlling the flow of refrigerant from the sensed vessel.

The refrigerant level sensor is located near the bottom of the condenser, intercooler, or flash tank. Access to its location may be physically challenging depending on the chiller model and its installation.

The probe portion of the sensor is installed in the chiller shell, and forms part of the refrigerant boundary (shell that contains the refrigerant) at the probe connection.

The sensor is secured to the shell using either a National Pipe Thread Taper (NPT) or Rotalock fitting (newer units).

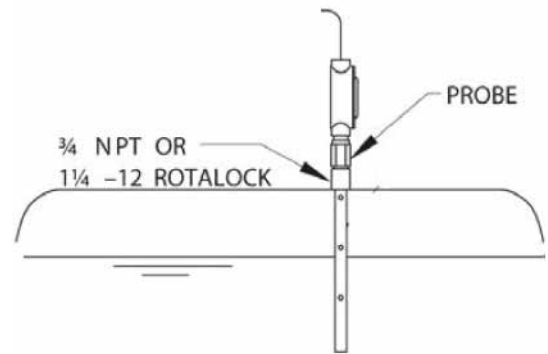

FIGURE 2 - SENSOR NPT OR ROTALOCK CONNECTION TO CONDENSER SHELL

REFRIGERANT LEVEL SENSOR

The sensor assembly consists of a probe and electrical enclosure.

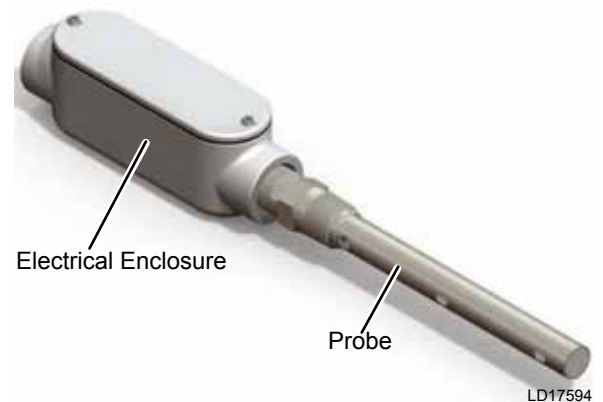

FIGURE 3 - SENSOR PROBE AND HOUSING

Each of the three sensors differ:

- In their physical construction (probe and rod)
- The signal transmitter board used in their electrical enclosure
- The attachment method of the probe to the electrical enclosure (tapered threads or slip joint with set screws)
- The attachment method of the probe to the vessel containing the refrigerant (NPT or Rotalock)
- Electrical connector or hardwire connection

Hansen Probe Assembly

The probe assembly consists of a:

- Shield and stem
- Rod with insulator internal to the shield
- Black wire (connected to rod) with blade terminal
- Potting compound applied to the threaded end of the probe to seal the assembly.

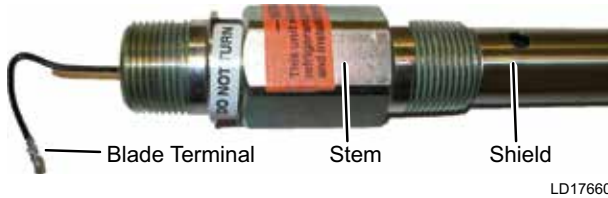

FIGURE 4 - HANSEN PROBE ASSEMBLY

CS01 Probe Assembly

The probe assembly consists of a:

- Shield and stem
- Rod with insulator and the following hardware:
 - Ferrule (seal)
 - Screw and washer for connection of the signal wire
- Nut for securing the probe to the stem

The rod contains a ferrule. When tightened against the probe with the nut, the ferrule seals the rod with the probe assembly. The ferrule seal may be at the other end of the stem on CS02 devices. The signal wire is secured on the end of the rod with a screw and washer.



FIGURE 5 - CS01 PROBE WITH ROD

CS02 Probe Assembly

The probe assembly consists of a:

- Shield and stem with O-rings
- Rod with insulator internal to the shield
- Screw and washer for connection of the signal wire

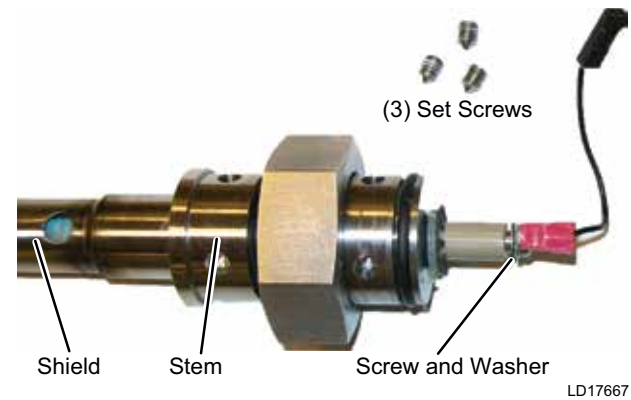

FIGURE 6 - CS02 PROBE ASSEMBLY

Electrical Enclosure Attachment to Probe Assembly

There are two methods of probe attachment to the electrical enclosure:

- The probe contains a tapered thread for attachment of the probe to the electrical enclosure (Hansen and CS01).
- The probe slides into the electrical enclosure and is secured by three set screws (CS02) (see *Figure 12 on page 9*).



FIGURE 7 - CS01 ELECTRICAL ENCLOSURE THREADED ONTO PROBE ASSEMBLY

Electrical Enclosure

The electrical enclosure contains a signal transmitter board which:

- Outputs a 0-5VDC analog voltage electrical signal to the control panel.
- Obtains DC power from the control panel

An electrical connector may be supplied at the end of the electrical enclosure.



LD17599

FIGURE 8 - PROBE ELECTRICAL ENCLOSURE AND SIGNAL TRANSMITTER BOARD

Sensor Wiring Connections

There are 3 sensor wiring connections:

- DC Power (Red)
- Common (Black)
- Signal Output (White)

Sensor Identification by Signal Transmitter Board

The signal transmitter board can be used to identify the sensor manufacturer and model. The electrical housing cover must be removed to view the signal transmitter board.

Hansen Sensor

The Hansen signal transmitter board may be covered with a potting compound or the board may be exposed.



LD17636

FIGURE 9 - HANSEN SIGNAL TRANSMITTER BOARD – WITH AND WITHOUT POTTING COMPOUND

The Hansen signal transmitter board contains the following components:

- 3-terminal strip
- Two potentiometers labeled Z and S
- Receptacle for the probe center electrode blade terminal (black wire)

CS01 Sensor

The CS01 signal transmitter board contains the following components:

- Green 3-terminal strip
- Four black pushbuttons

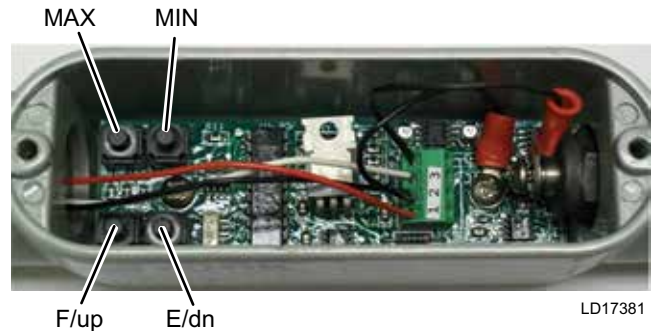

LD17381

FIGURE 10 - CS01 SIGNAL TRANSMITTER BOARD

CS02 Sensor

The CS02 signal transmitter board contains the following components:

- Green 3-terminal strip
- Four pushbuttons; yellow, green, two grey
- LED display

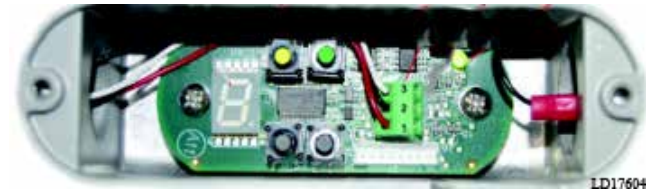

LD17604

FIGURE 11 - CS02 SIGNAL TRANSMITTER BOARD

For further identification, the CS02 electrical housing is attached to the probe with a slip joint into the housing, and is secured with three pointed set screws to the probe stem.

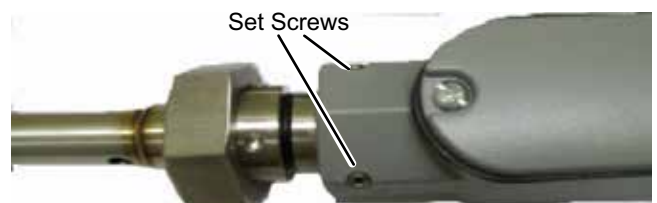

LD17605

FIGURE 12 - CS02 SENSOR PROBE MOUNTING

THIS PAGE INTENTIONALLY LEFT BLANK.

SECTION 2 - TROUBLESHOOTING

REFRIGERANT LEVEL FUNCTION TEST

If a refrigerant level problem exists, a test to validate whether the sensor is functioning properly will need to be performed. The problem could be the sensor, the chiller wiring, the chiller controls, or the plant system. A simple test will determine if the sensor is performing its function or if the problem exists elsewhere. This test, as outlined in the flowchart below, consists of manually raising and lowering the refrigerant level on the control panel and viewing the sensor probe through the sight glass.

As the refrigerant level is raised (or lowered) the sensor should correctly indicate the refrigerant level on the control panel display. If it does not, there may be a sensor malfunction (see *Figure 14 on page 12*). If it does correctly indicate the refrigerant level at both 100% and 0%, then there may be a system malfunction (see *Figure 15 on page 14*).

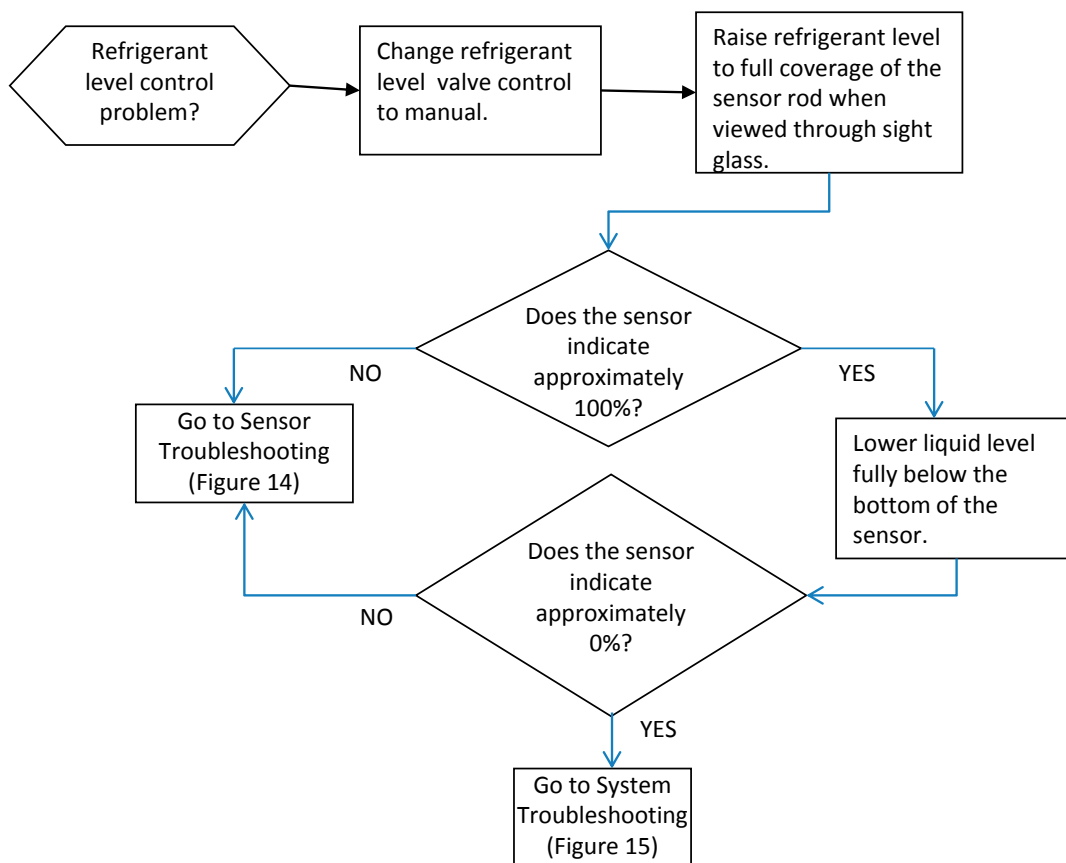
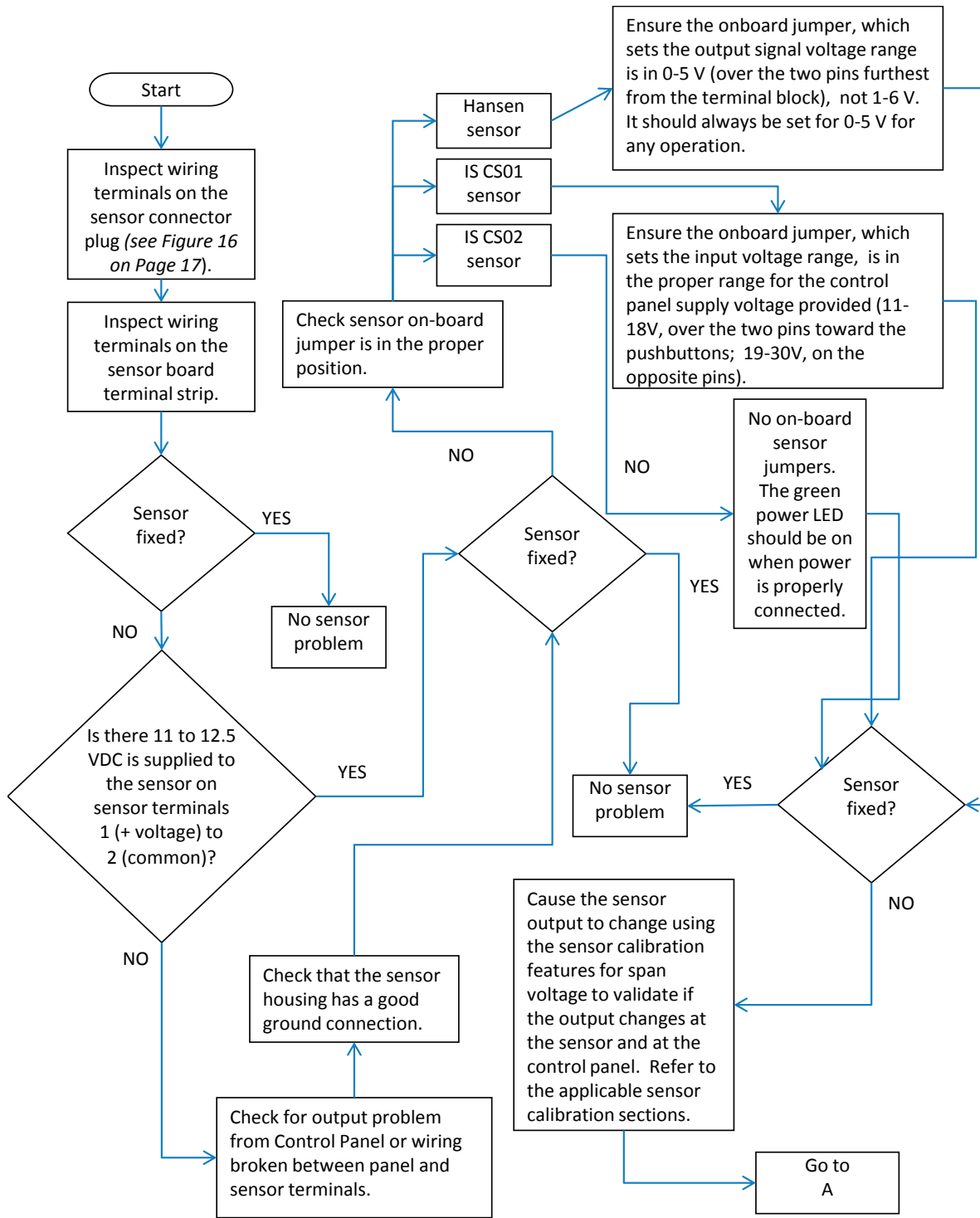

FIGURE 13 - REFRIGERANT LEVEL TEST FLOWCHART

LD17646



LD17647

Refer to *Table 1 on page 16 for additional information on Sensor Troubleshooting*

FIGURE 14 - SENSOR TROUBLESHOOTING FLOWCHART

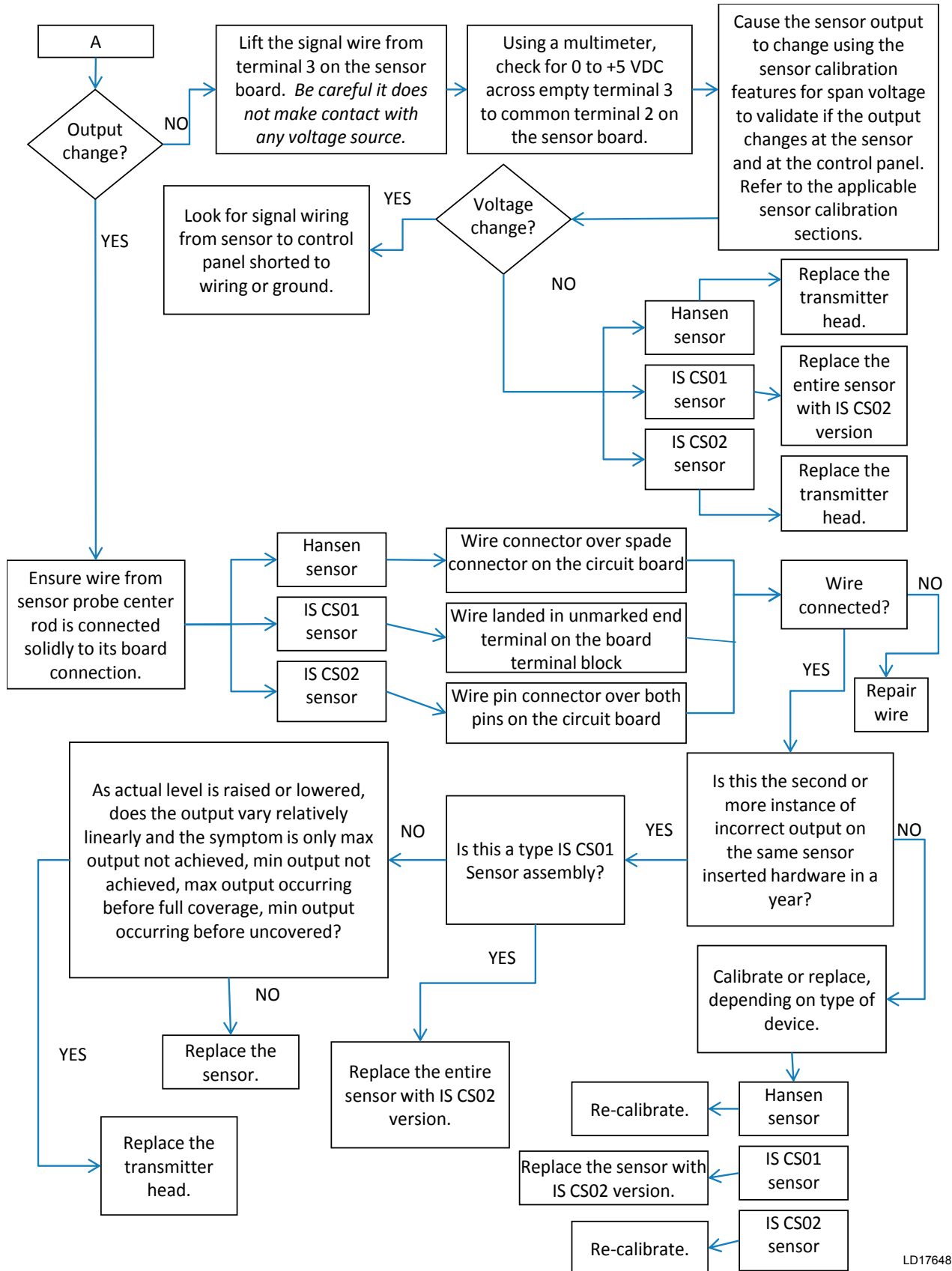

LD17648

FIGURE 14 - SENSOR TROUBLESHOOTING FLOWCHART (CONT'D)

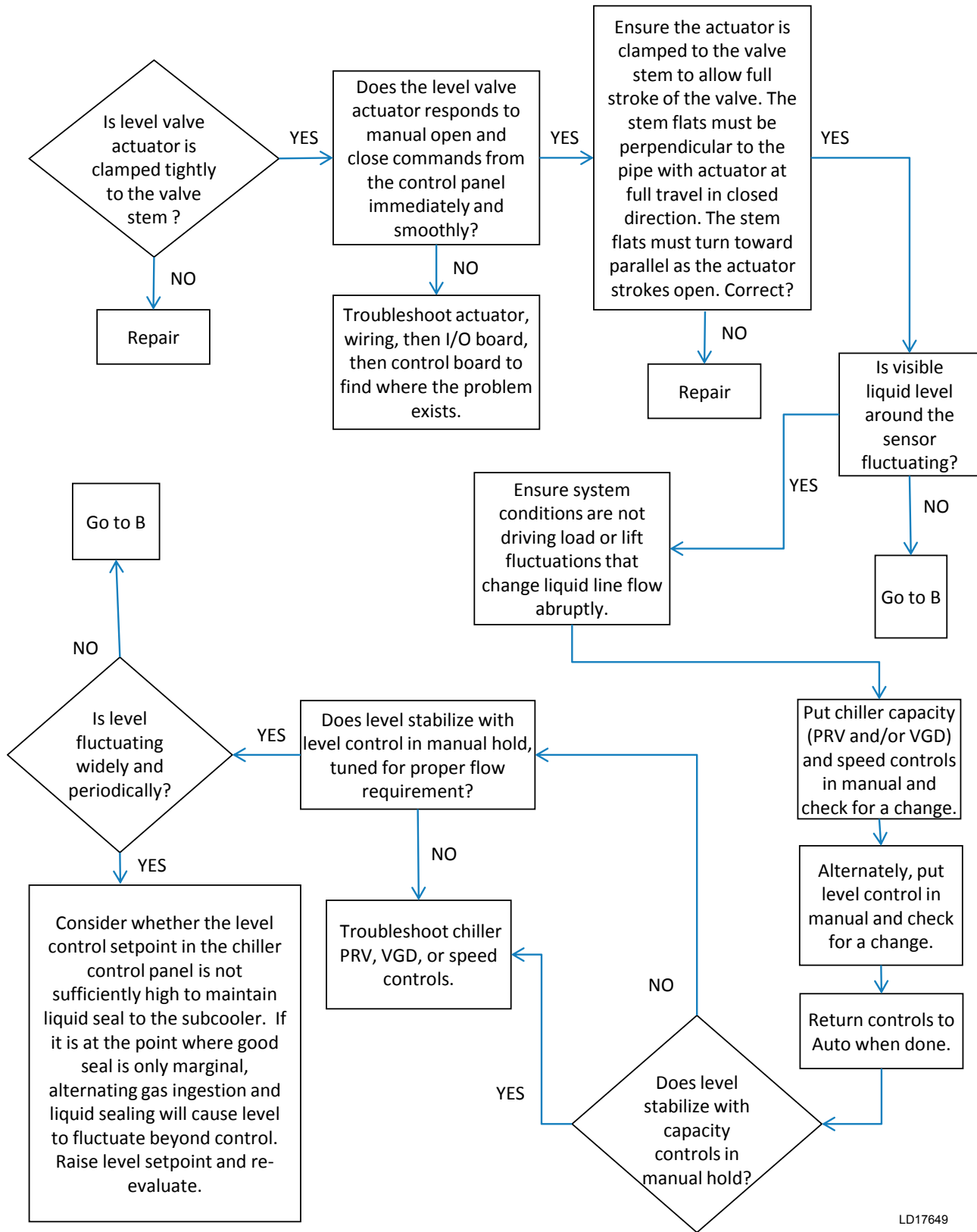

LD17649

FIGURE 15 - SYSTEM TROUBLESHOOTING FLOWCHART

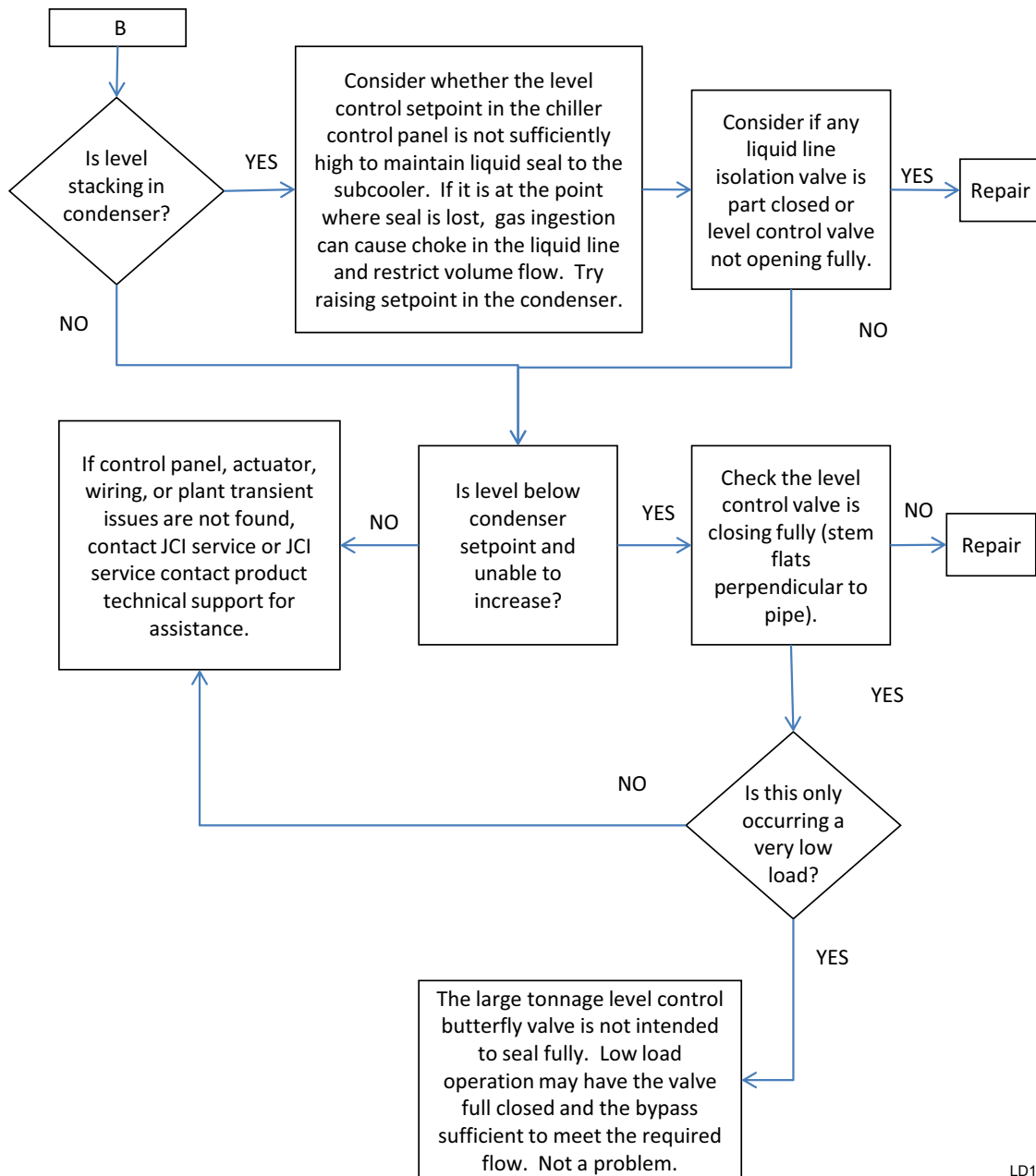

LD17650

FIGURE 15- SYSTEM TROUBLESHOOTING FLOWCHART (CONT'D)

TABLE 1 - SENSOR HARDWARE AND WIRING TROUBLESHOOTING

HARDWARE	VALIDATE	REMEDY
1. CHECK SENSOR WIRING		
1. Connector on cable from control panel. 2. Connector on sensor. 3. Signal transmitter board terminal strip.	1. Wiring connections at cable connector (see <i>Figure 16 on page 17</i>). 2. Wiring connections at sensor connector. 3. Wiring connections on signal transmitter board: Terminal 1: Red wire Terminal 2: Black wire Terminal 3: White wire Note: CS01 has 4 terminals - 4th unmarked terminal is the probe wire.	Correct any wiring issues; loose terminals or wiring under terminals.
2. CHECK SENSOR POWER		
Signal transmitter board.	Proper DC voltage present at terminals 1 and 2. Optiview™ panels supply 11 to 12.5VDC. Other panels may use 24 VDC.	1. Check voltage output from control panel. 2. Check cable wiring connections at control panel. 3. Check cable wiring between control panel and the sensor.
3. CHECK SENSOR ON-BOARD JUMPERS		
Use the applicable sensor procedure when performing this validation.		
Hansen Output signal range jumper.	1. Jumper is located over two pins furthest from the three terminal block (0-5VDC range). 2. Jumper is fully inserted onto the pins.	1. Locate jumper on correct two pins. 2. Press jumper down onto pins until it is fully seated against the board.
CS01 Voltage range jumper.	1. Jumper is located over two pins located towards the four pushbuttons when 11-18VDC is supplied by the panel, and is on the other two pins when 19 to 30 VDC is supplied. 2. Jumper is inserted fully onto the pins.	1. Locate jumper to correct two pins. 2. Press jumper down onto pins until it is fully seated against the board.
4. CHECK SENSOR GROUND		
Use the applicable sensor procedure when performing this validation.		
All Sensors Housing attachment to probe.	Housing attached solid to probe with no teflon tape.	Fix as required.
IS CS01 1. Ring terminal connection to board. Reference <i>Figure 12 on page 12</i> . 2. Star washer under ring terminal. 3. Blk wire connection from ring terminal to terminal 2.	1. Screw connection is tight. 2. Star washer under ring terminal has internal teeth. 3. Blk wire connection is tightly secured in ring terminal (crimp) and at terminal 2 (screw).	1. Tighten screw connection. 2. Replace star washer if it has external teeth. 3. Tighten wire connections.
5. CHECK SENSOR PROBE WIRING CONNECTIONS		
Use the applicable sensor procedure when performing this validation.		

TABLE 1- SENSOR HARDWARE AND WIRING TROUBLESHOOTING(CONT'D)

HARDWARE	VALIDATE	REMEDY
Hansen 1. Blade terminal connection from the probe to the receptacle on the signal transmitter board. 2. Wiring crimp connection in the blade terminal.	1. Blade terminal is fully inserted into its receptacle. 2. Wiring connection at blade terminal crimp is securely crimped.	1. Insert blade terminal fully into its receptacle on the board. 2. Recrimp wire at blade terminal.
CS01 1. Probe wire connection (Blk) in the terminal block 4th terminal (unmarked). 2. Probe wire connection to center electrode.	1. Probe wire is under terminal screw and terminal screw is tightened. 2. Probe wire is secured to center electrode with screw and washer.	1. Loosen terminal screw, reposition probe wire under screw and tighten. 2. Secure probe to center electrode with screw and washer.
CS02 Probe wiring connector that attaches to signal transmitter board.	Connector is fully inserted onto the pins with the wire on the pin closest to the power LED.	Remove connector, check pins for alignment, and reinsert connector until it is fully seated against the connector.

2

Level Sensor Connector Wiring

When the cable wires are packed into the DIN connector housing close to the connector terminals, ensure that the cable shield (cut off at the cable jacket) will not make contact with any of the connector conductive surfaces or the pins on the terminals.

A field fix for covering the shield may be to either wrap the end of the cable jacket with electrical tape or to add heat shrink tubing to the end of the cable jacket.

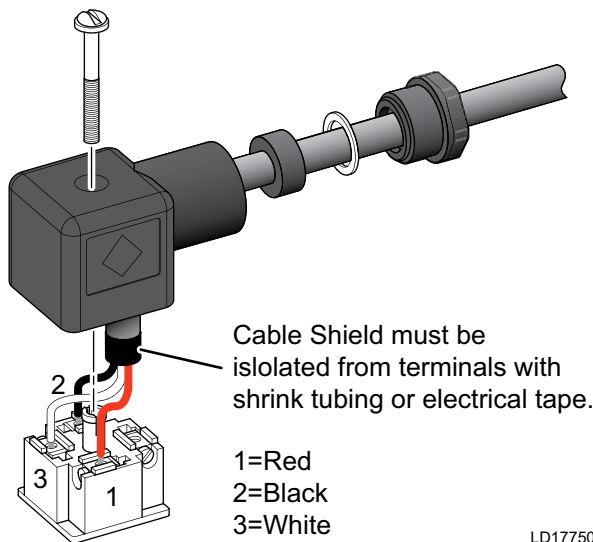

FIGURE 16 - LEVEL SENSOR CONNECTOR WIRING

THIS PAGE INTENTIONALLY LEFT BLANK.

SECTION 3 - SENSOR REMOVAL AND INSTALLATION

This section details the steps necessary for refrigerant level sensor electrical enclosure removal and replacement, or complete sensor removal and replacement.

HANSEN SENSOR

Replace the electrical enclosure with a new Hansen electrical enclosure; part number 025-34146-000.

Replace the entire sensor using the part number in the chiller service parts manual. Parts are superseded to the CS02 where appropriate.

The probe portion of the Hansen sensor in the chiller shell is part of the refrigerant boundary at the pipe threads (older units) or Rotalock nut (newer units). The electrical enclosure is attached to the probe with tapered pipe threads into the housing.

Electrical Enclosure Removal

1. Remove power from the sensor.
2. Open the electrical enclosure (see *Figure 19 on page 23*). Remove the wiring connector from the sensor, if present, or disconnect the 3 sensor cable wires from the sensor terminal strip.
3. Remove the black probe wire from the signal transmitter board by pulling the blade terminal on the board inside the housing.
4. Hold the flats of the sensor probe securely in position and turn the electrical enclosure off with an adjustable wrench at the strongest part of the enclosure.

New Electrical Enclosure Installation

1. Hold the flats of the sensor probe and turn the electrical enclosure onto the probe with an adjustable wrench at the strongest part of the housing.
2. Install the black probe wire.
3. Reconnect the 3 sensor cable wires or the connector plug.
4. Power to the sensor.
5. Start up chiller.
6. Sensor calibration (See *Section 4 - Refrigerant Level Sensor Calibration*).

Complete Hansen Sensor Removal

1. Secure the chiller and move refrigerant out of the condenser.
2. Remove power from the sensor.
3. Remove the wiring connector from the sensor.
4. Loosen the Rotalock probe nut or unscrew the NPT probe and remove the shell coupling.

New Sensor Installation

1. Install the replacement with a new Teflon O-ring for the Rotalock joint (O-ring comes with a probe assembly), or tighten the NPT joint.

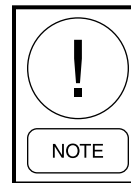

Only if the chiller was older and used an NPT connection to the shell, use refrigerant grade sealant on the threads, such as Loctite 515.

2. Reconnect the 3 sensor cable wires or the connector plug.
3. Leak check, evacuate, and recharge the chiller with refrigerant.
4. Confirm the sensor is operating properly by performing the Refrigerant Level Function test (See *Section 2 - TROUBLESHOOTING*).

CS01 SENSOR

Unlike the Hansen sensor and its electrical enclosure replacement, all CS01 sensors will be replaced with the CS02 complete sensor. This includes CS01 sensors that require calibration or have a defective signal transmitter board. The CS02 sensors are calibrated at the factory.

TABLE 2 - CS02 SENSOR PART NUMBERS WITH ROTALOCK END FITTINGS

MODEL	PROBE MEASUREMENT RANGE	JCI PART* NUMBER
CS02	6-1/2"	025-46044-006
CS02	8-1/2"	025-46044-008
CS02	9-1/2"	025-46044-009

*Refer to the chiller parts manual for NPT sensors. CS02 or Hansen sensors will be available.

The probe portion of the CS01 sensor in the chiller shell is part of the refrigerant boundary at the pipe threads (older units) or Rotalock nut (newer units). The electrical enclosure is attached to the probe with tapered threads into the housing.

Replacing the CS01 Sensor with a CS02

CS01 Removal

1. Secure the chiller and move refrigerant out of the condenser.
2. Remove power from the sensor (see *Figure 22 on page 24*). Remove the wiring connector from the sensor.
3. Loosen the Rotatlock probe nut or unscrew the NPT probe and remove from the shell coupling.

CS02 Installation

1. Install the replacement with a new Teflon O-ring for the Rotalock joint (O-ring comes with a probe assembly).

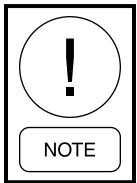

Only if the chiller was older and used an NPT connection to the shell, use refrigerant grade sealant on the threads, such as Loctite 515.

2. Install the sensor connector.
3. Leak check, evacuate, and recharge the chiller with refrigerant.
4. Refrigerant to condenser.
5. Confirm the sensor is operating properly by performing the Refrigerant Level Function test (See *Section 2 - TROUBLESHOOTING*).

CS02 SENSOR

In some instances, it may be necessary to replace the CS02 electrical enclosure.

The replacement part number for the CS02 electrical enclosure is 325-46338-001.

The probe portion of the sensor in the chiller shell is part of the refrigerant boundary at the Rotalock nut. The electronic head is attached to the probe stem with a slip joint into the housing, and secured with set screws. The assembly is sealed with twin O-rings.

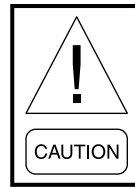

Do not attempt to disassemble the stem from the chiller shell as it forms the refrigerant seal for the center electrode and its insulator.

Removal of Existing CS02 Electrical Enclosure

1. Remove power from sensor.
2. Remove the external wiring connector from the sensor.
3. Open the electrical enclosure (see *Figure 23 on page 25*). Remove the probe wire by pulling the connector from the two pins on the board inside the housing.
4. Fully remove the three set screws in the hex nose of the housing. These must be fully removed to prevent damage to the seal O-rings on the probe stem.
5. Pull the electrical enclosure from the probe stem.

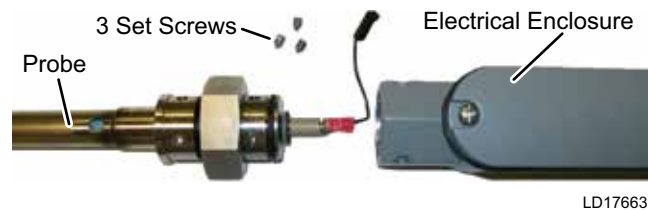

FIGURE 17 - CS02 PROBE SEPARATED FROM ELECTRICAL ENCLOSURE

Installation of new CS02 Electrical Enclosure

1. Ensure probe wire blade terminal is firmly attached to center rod with the Phillips screw.
2. Ensure the three set screws are removed from the neck on the electrical enclosure.

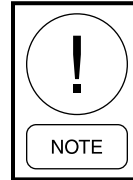

FIGURE 18 - CS02 PHILLIPS SCREW AND WIRE BLADE TERMINAL

3. Slide the probe wire into the electrical enclosure and feed the new enclosure over the O-rings on the probe stem until it bottoms.
4. Orient the enclosure as needed for access and install the three setscrews, tightening evenly.
5. Connect the probe wire connector over the two pins so that the wire is on the pin closest to the probe end of the enclosure.
6. Confirm the sensor is operating properly by performing the Refrigerant Level Function test (See *Section 2 - TROUBLESHOOTING*).

Replacing the Complete CS02 Sensor

1. Secure the chiller and move refrigerant out of the condenser.
2. Remove the wiring connector from the sensor.
3. Loosen the Rotatlock probe nut or unscrew the NPT probe and remove from the shell coupling.
4. Install the replacement with a new Teflon O-ring for the Rotalock joint (O-ring comes with a probe assembly).



Only if the chiller was older and used an NPT connection to the shell, use refrigerant grade sealant on the threads, such as Loctite 515.

5. Confirm the sensor is operating properly by performing the Refrigerant Level Function test (See *Section 2 - TROUBLESHOOTING*).

THIS PAGE INTENTIONALLY LEFT BLANK.

SECTION 4 - REFRIGERANT LEVEL SENSOR CALIBRATION

This section provides calibration instructions for the Hansen, CS01, and CS02 sensors.

A complete understanding of the steps outlined in these instructions is required prior to sensor calibration.

HANSEN SENSOR

Calibration is done using the ZERO and the SPAN potentiometers. The device maximum full scale output voltage signal (5VDC) is a value set by the output jumper (0-5 position).

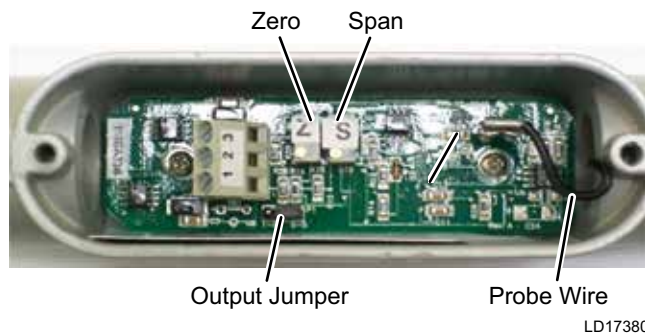

FIGURE 19 - HANSEN SENSOR

ZERO Potentiometer

Only adjust ZERO when the refrigerant level is below the probe surface as shown below. Adjust the ZERO potentiometer to achieve approximately 0 to 0.45 VDC (0 to 2%) output when refrigerant level is minimum in the vessel.

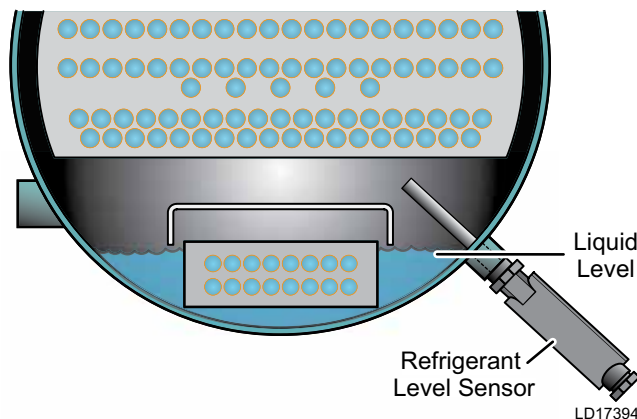

FIGURE 20 - PROBE UNCOVERED –
REFRIGERANT AT EMPTY LEVEL

SPAN Potentiometer

The amount of probe coverage at which the full scale output voltage is provided is adjusted by the SPAN potentiometer.

The span should only be adjusted with the probe fully covered as shown below in order to display nearly 100% level at the panel. The span should not be adjusted with level below full coverage because the resulting output at full coverage will be unknown.

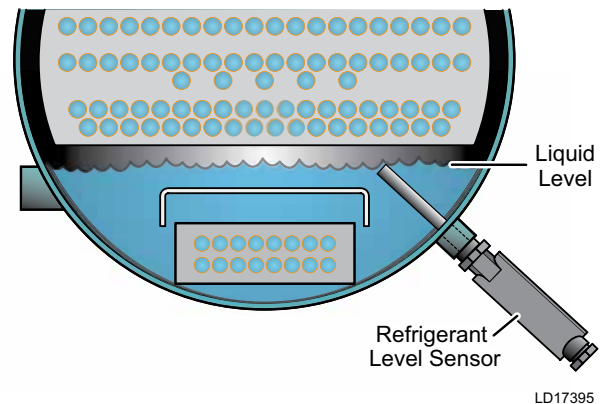

FIGURE 21 - PROBE FULLY SUBMERGED –
REFRIGERANT AT FULL LEVEL

A panel display of > 100% is incorrect because that creates an unknown deadband in control until the level decreases on the probe enough for the signal voltage to drop into the useable range of the panel.

Zero adjustment moves a few tenths during a large span adjustment and should be reset iteratively with span adjustments. Zero adjustment should only be done with the refrigerant level at probe base or off of the probe.

CS01 SENSOR

Four independent programmable values define the operation of the device. These values are:

1. Bottom of span output voltage.
2. Top of span output voltage.
3. Bottom of span refrigerant level.
4. Top of span refrigerant level.

Pushbutton States of Operation

No pushbuttons depressed

Normal operation responding to refrigerant level.

MIN pushbutton depressed and held

The sensor outputs the voltage preset for the bottom of working span; the MIN pushbutton enables bottom span voltage adjustment. With MIN depressed, device output has nothing to do with existing refrigerant level.

MAX pushbutton depressed and held

The sensor outputs the voltage preset for the top of working span; the MAX pushbutton enables top span voltage adjustment. With MAX depressed, device output has nothing to do with existing refrigerant level.

MIN and MAX pushbuttons depressed simultaneously

Enters probe level calibration mode. The device is reading the existing refrigerant level awaiting the user to assign this level as the top or bottom of span.

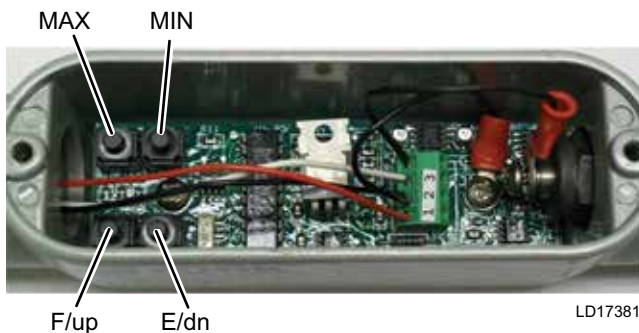
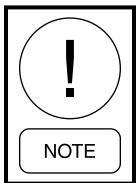

FIGURE 22 - CS01 SENSOR



If the existing response is satisfactory, adjustment in the field is not recommended.

Verify and Adjust Bottom of Span Output Voltage

1. Press and hold the MIN pushbutton. The sensor output should be approximately 0.4VDC, and the Control Panel screen should display a level between 0% and 2%; not < 0%.
2. If adjustment is required, press and hold the MIN button while momentarily pressing either the F/up or E/dn buttons to obtain the voltage value referenced in Step 1.

Verify and Adjust Top of Span Output Voltage

1. Press and hold the MAX pushbutton. The sensor output should be 5 VDC, and the Control Panel screen should display a level between 98% and 100%; not > 100%.

2. If adjustment is required, press and hold the MAX button, while momentarily pressing either the F/up or E/dn buttons to obtain the voltage value referenced in Step 1.

Verify and Adjust the Bottom of Span Refrigerant Level Setpoint

The full range of the probe must be effective, so this calibration needs to be done while the probe is completely uncovered with refrigerant (see *Figure 20 on page 23*). If this calibration procedure is done at any other refrigerant level, the transmitter will accept this refrigerant level position as the bottom of span and performance will be unsatisfactory.

1. Force the refrigerant level below the probe. For condensers, it may be necessary to flow warm condenser water to drive refrigerant to the evaporator.
2. With the liquid level at the base of the sensor, press and hold the MAX, MIN, and E/dn buttons for approximately 5 seconds to register the bottom of span position (E for Empty tank setpoint).

Verify and Adjust the Top of Span Refrigerant Level Setpoint

The full range of the probe must be effective, so this calibration needs to be done while the probe is completely covered with refrigerant (see *Figure 21 on page 23*). If this calibration procedure is done at any other refrigerant level, the transmitter will accept this refrigerant level position as the end of span and performance will be unsatisfactory.

1. With the chiller at a load where it is not likely to trip the unit on low evaporator pressure or cause surging, manually throttle the control valves to raise the refrigerant level above the top of the probe.
2. With the liquid level over the full sensor, press and hold the MAX, MIN, and F/up buttons for approximately 5 seconds to register the top of span position (F for Full tank setpoint).

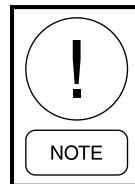

An alternate time to set this is with chiller off and all charge pumped in the condenser when condenser isolation valves exist or a falling film evaporator exists.

CS02 SENSOR

An understanding of this sensor and of Modes 0, 1, 2, and 3 are required prior to sensor calibration.

The CS02 sensor is shipped from the factory with the bottom of span point calibrated in R134a vapor, with the liquid level at the edge of the hole closet to the sensor mount. Full scale calibration is done with the sensor fully submerged in R-134a liquid. Follow the instructions in this section only when the sensor is not functioning properly.

Spanning and Calibrating Modes of Operation

The device has program options selected with the MODE button (see *Figure 23 on page 25*). Modes 0 through 3 set the basic sensor operation.

MODE 0

Set Span Voltage Low (Output Reading at “EMPTY”)

MODE 1

Set Span Voltage High (Output Reading at “FULL”)

MODE 2

Calibration Low (Calibration Point at “EMPTY”)

MODE 3

Calibration High (Calibration Point at “FULL”)

Changing Modes

Pressing the MODE button will toggle through the following modes in order: 0 to 9, L, F, P, and A.

The device must be returned to Mode “A” for normal running operation. The single-digit LED display will be blank when in Mode “A” for normal run.

Pressing the MODE button and holding for about 2 seconds initiates change of mode and illuminates the display. Modes will be advanced when the SET button is pressed to accept a new input, or the MODE button is pressed to move to the next mode WITHOUT accepting the present change. When the MODE is returned to “A”, it is illuminated briefly and then the display returns to blank.

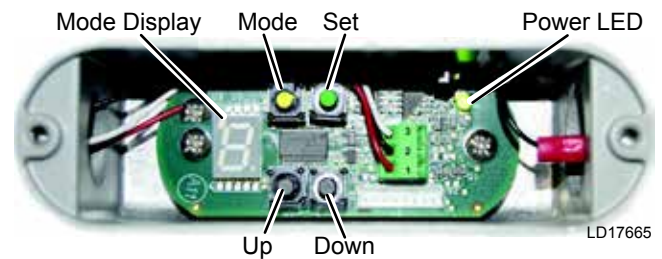
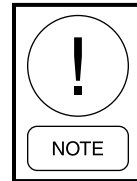

FIGURE 23 - CS02 SENSOR



If the existing response is satisfactory, adjustment in the field is not recommended.



Set voltage output for low end of span (Mode 0)

1. Press the MODE button until a “0” is illuminated on the display.
2. Tap the UP and DOWN buttons to set a low end voltage output that yields 0 to 2% at the display.
3. Press the SET button to accept. The mode will automatically switch to MODE 1.



Set voltage output for high end of span (Mode 1)

1. MODE 1 should be displayed from the previous step. If not, press the MODE button until a “1” is illuminated on the display.
2. Tap the UP and DOWN buttons to set the high end voltage output that yields 98 to 100% at the display.
3. Press the SET button to accept. The mode will automatically switch to MODE 2.

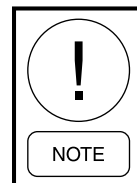

In order to calibrate MODES 2 or 3, the intended refrigerant should be used. During the calibration process, the refrigerant will need to be raised and lowered to the desired “empty” and “full” locations on the sensor probe.



Calibrate Low Level (Mode 2)

1. MODE 2 should be displayed from the previous step. If not, press the MODE button until a “2” is illuminated on the display.
2. Position the media level to the desired location on the sensor probe for the “EMPTY” level.
3. Press the SET button. The mode will automatically switch to MODE 3.

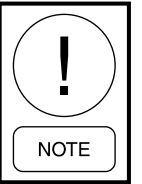

Voltage output to panel will not reflect refrigerant level WHILE STILL IN this mode. Ignore the voltage output while performing this function.



Calibrate High Level (Mode 3)

1. MODE 3 should be displayed from the previous step. If not, press the MODE button until a “3” is illuminated on the display.
2. Position the media level to the desired location on the Sensor Probe (probe fully submerged).
3. Press the SET button. The mode will automatically switch to MODE 4.

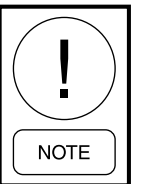

Voltage output to panel will not reflect refrigerant level WHILE STILL IN this mode. Ignore the voltage output while performing this function.

Tuning Modes – Modes 4-9, and L

These modes enable the end user to adjust various aspects of the sensor response, which are not normally required for application on a chiller.

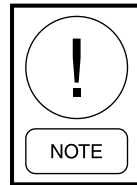

Adjustments in modes 4-9 are not recommended.

For Modes 4-9, L; use only the MODE button to navigate past these settings to return to run mode without inadvertently changing any of these advanced settings.

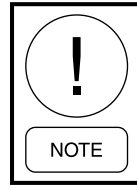

For all of the following examples, the term “input span” will be used. This relates to the calibrated input levels and not the span output (i.e., 0-5 VDC). The input span is determined upon the calibration of the sensor. In the following examples, changes will be made to the operational values of the span.

In all cases, it is advised to have a multimeter attached to the #2 negative ground and #3 signal terminal while performing these adjustments.



Resolution (Mode 4)

Adjustments in this mode are not recommended. Use the MODE button to pass through this mode without making changes. The default sensitivity matches the design of the chiller controls.

The Resolution Mode allows the end user to make fine adjustments to the sensitivity of the output change relative to the change in media level (with default settings, the resolution is set for 1024 points over the span length). *Resolution (in.) = Span Length/1024*

1. Press the MODE button until a “4” is illuminated on the display.
2. Press the UP and DOWN buttons to toggle to the desired display digit that represents the resolution desired. On the display, the submode digit will end with a dot (.) as not to confuse them with the main modes. Submodes provide an exact inch resolution.
3. Press the SET button. The sensor is now set for the new resolution selected.

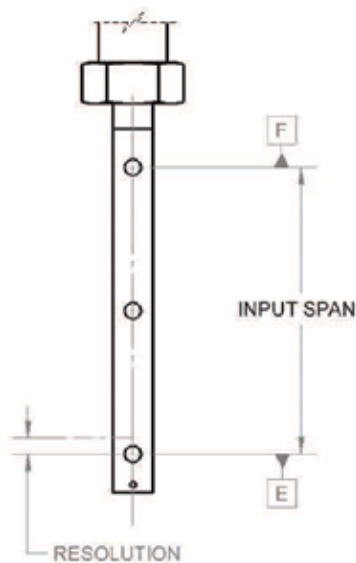

LD17396

FIGURE 24 - MODE 4 – SPAN RESOLUTION



Fifty Percent (50%) Tuning (Mode 5)

Adjustments in this mode are not recommended. Use the MODE button to pass through this mode without making changes.

The 50% Tuning Mode allows the end user to set the predetermined 50% output value to the perceived media level.

For instance, if the media level is at the 50% point on the probe, yet the output reading deviates from the configuration’s expected output, then employing Mode 5 will set the output value to the expected output, shifting the calibrated empty to full span around the prevailing level.

A risk with using this feature is pushing the span beyond the physical limits of the probe and clipping the output at either end, causing inability of the chiller control panel to react to excursions in level properly.

1. Press the MODE button until a “5” is illuminated on the display.
2. Press the SET button. The sensor is now adjusted to the single point media level.

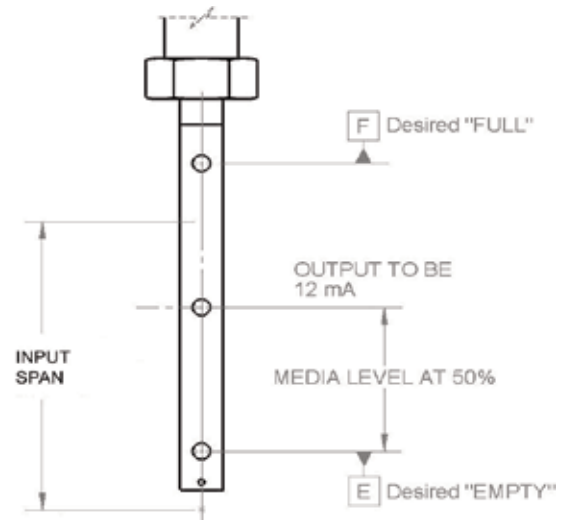

LD17397

FIGURE 25 - MODE 5 – 50% TUNING MODE



Span Shifting (Mode 6)

Adjustments in this mode are not recommended. Use the MODE button to pass through this mode without making changes.

The Span Shifting Mode is similar to Mode 5, with the exception of being utilized at any given level and employing the UP and DOWN buttons. With Mode 6, the end user is able to incrementally shift the input span length toward a known point and output on the probe.

A risk with using this feature is pushing the span beyond the physical limits of the probe and clipping the output at either end, causing inability of the chiller control panel to react to excursions in level properly.

1. Press the MODE button until a "6" is illuminated on the display.
2. Press the UP and DOWN buttons to toggle to the desired output, relative to the media level on the probe.
3. Press the SET button. The sensor is now adjusted to the single point media level.



FIGURE 26 - MODE 6 – SPAN SHIFTING



Increase/Decrease Span from Low (Mode 7)

Mode 7 changes the input span length and is to be used when the low-level output is correct, but fully covered cannot be determined, so an intermediate coverage position is used to set the second point of span calibration. The user can incrementally increase or decrease the input span length toward a known point and output on the probe. Mode 7 is useful when the 100% level cannot be viewed in the application.

1. Press the MODE button until a “7” is illuminated on the display.
2. Press the UP and DOWN buttons to toggle to the desired output, relative to the media level on the probe.
3. Press the SET button. The sensor is now adjusted to the proper output for the media level and linearizes to the rest of the sensor length.

EXAMPLE: An application shows that the maximum output is being attained before the media can reach the intended high level. Currently, the media level is at 50% of the probe span. In this 4-20 mA output sensor, the expected output current should be 12.0 mA, as shown below. However, the actual output reading is 14.8 mA. By using mode 7, the output can be adjusted down to 12.0 mA by using the “up” and “down” buttons. This method will retain linearity, but the input span length will change, as shown below.

2

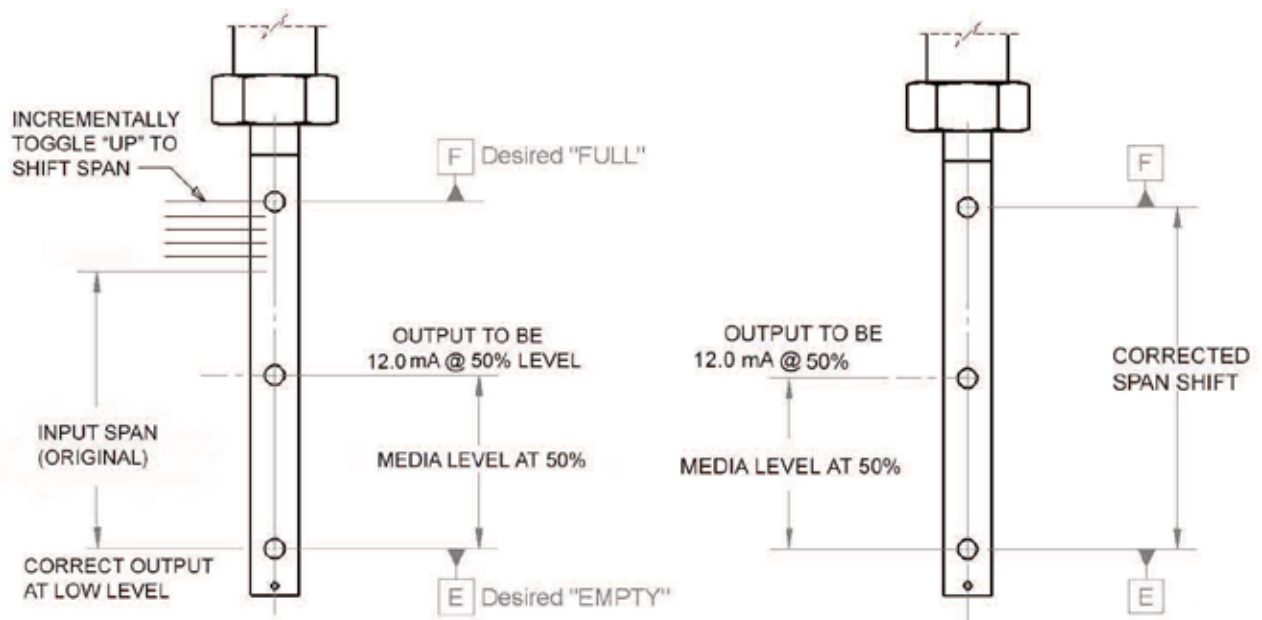

LD17399

FIGURE 27 - MODE 7 – INCREASE/DECREASE SPAN FROM LOW



Increase/Decrease Span from High (Mode 8)

Mode 8 is similar to Mode 7. It is useful when the high-level output is correct, but fully uncovered cannot be determined, so an intermediate coverage position is used to set the second point of span calibration. The user can incrementally increase or decrease the input span length toward a known point and output on the probe. Mode 8 is helpful when the 0% level cannot be viewed in the application.

1. Press the MODE button until an "8" is illuminated on the display.
2. Press the UP and DOWN buttons to toggle to the desired output, relative to the media level on the probe.
3. Press the SET button. The sensor is now adjusted to the proper output for the media level and linearizes to the rest of the sensor length.

EXAMPLE: An application shows that the minimum output is being attained before the media can reach the intended high level. Currently, the media level is at 50% of the probe span. In this 4-20 mA output sensor, the expected output current should be 12.0 mA, as shown below. However, the actual output reading is 9.5 mA. By using mode 8, the output can be adjusted up to 12.0 mA by using the "up" and "down" buttons. This method will change linearity, but the input span length will change as shown below.

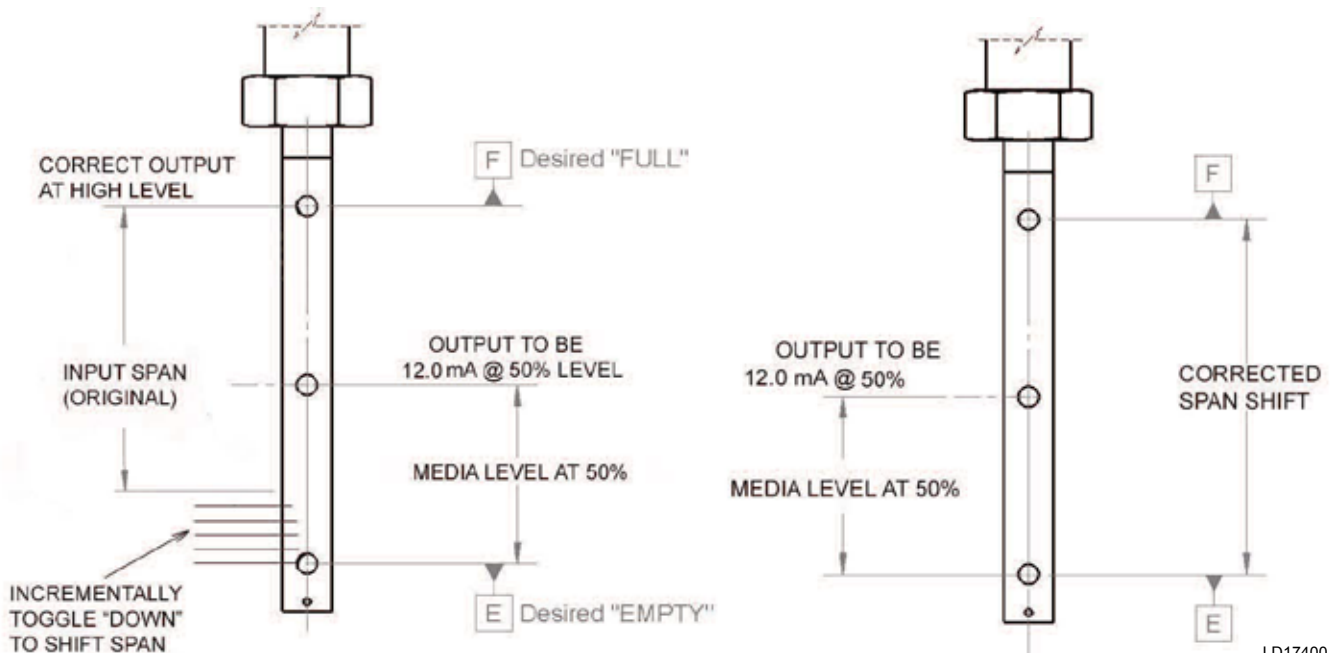

LD17400

FIGURE 28 - MODE 8 – INCREASE/DECREASE SPAN FROM HIGH



Increase/Decrease Span from Midpoint 50% (Mode 9)

Adjustments in this mode are not recommended. Use the MODE button to pass through this mode without making changes.

Mode 9 performs a symmetrical incremental increase or decrease of the input span length around the present level on the probe. Mode 9 is helpful when the entire probe can be viewed in the application.

A risk with using this feature is pushing the span beyond the physical limits of the probe and clipping the output at either end, causing inability of the chiller control panel to react to excursions in level properly.

1. Press the MODE button until 1 a "9" is illuminated on the display.
2. Press the UP and DOWN buttons to toggle to the desired output, relative to the media level on the probe.
3. Press the SET button. The sensor is now adjusted to the proper output for the media level.

2

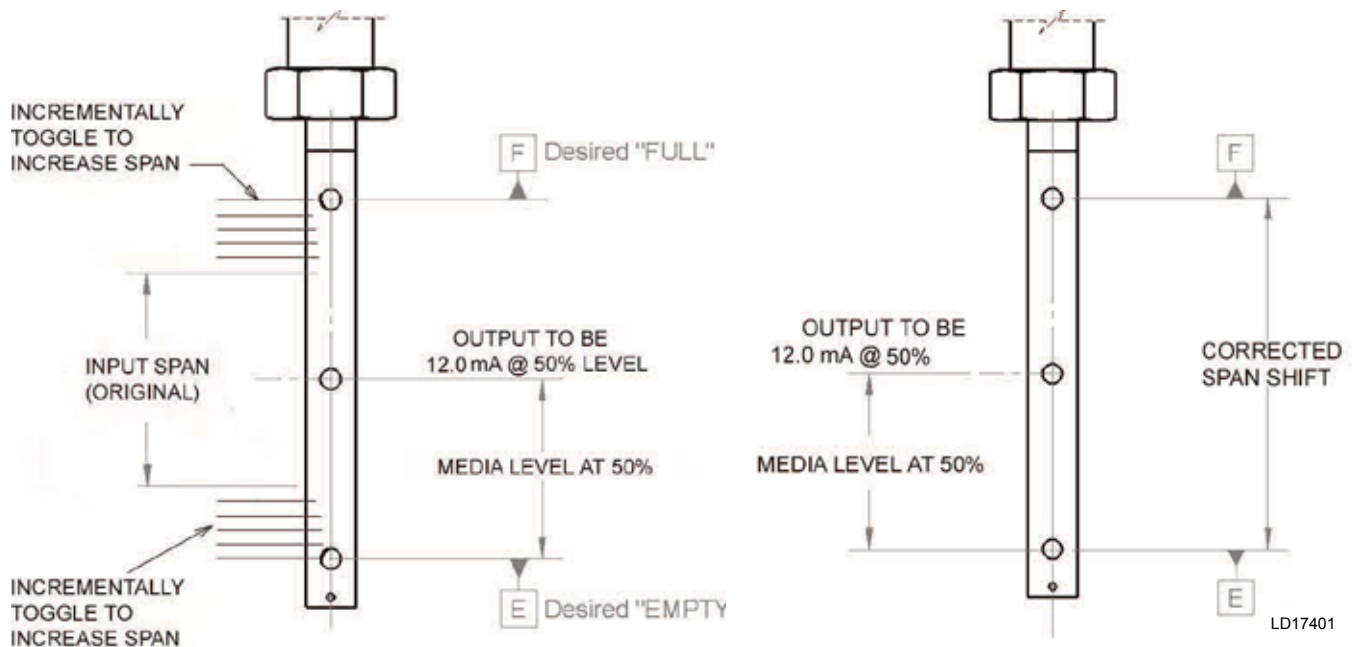

LD17401

FIGURE 29 - MODE 9 – INCREASE/DECREASE SPAN FROM MIDPOINT 50%



Linearity Tuning (Mode L)

Adjustments in this mode are not recommended. Use the MODE button to pass through this mode without making changes.

Mode L allows the user to adjust the linearity of the output readings to a desired output at any given point on the probe (excludes high and low levels). It is useful when the entire probe can be viewed in the application. High and Low Level outputs should be known to be correct.

1. Press the MODE button 1 until an “L” is illuminated on the display.
2. Press the UP and DOWN buttons to toggle to the desired output, relative to the media level on the probe.
3. Press the SET button. The sensor is now adjusted to a skewed output around the present media level.

Function Modes (F, P, and A)

The Function Modes do not affect the Span, Calibration or Advanced Tuning Functions.



Mode F: Reset Calibration to Last Known Settings

Pressing SET in this mode is a fail-safe to undo any setting changes made away from the recommended default in the advance modes.

1. Press the MODE button until an “F” is illuminated on the display.
2. Press the SET button to reset calibration to the last accepted Modes 0 to 3 settings (voltage span, empty, and full). This effectively removes any of the advanced tuning changes done with Modes 4 to 9, or L.



Mode P: View Current Program Version

1. Press the MODE button until a “P” is illuminated on the display.
2. Press the SET button. The program version will appear on the display.



Mode R: Set Sensor to “RUN” Mode

1. Press the MODE button until an “A” is illuminated on the display.
2. After a second, the display will turn off and the sensor will be in RUN mode.

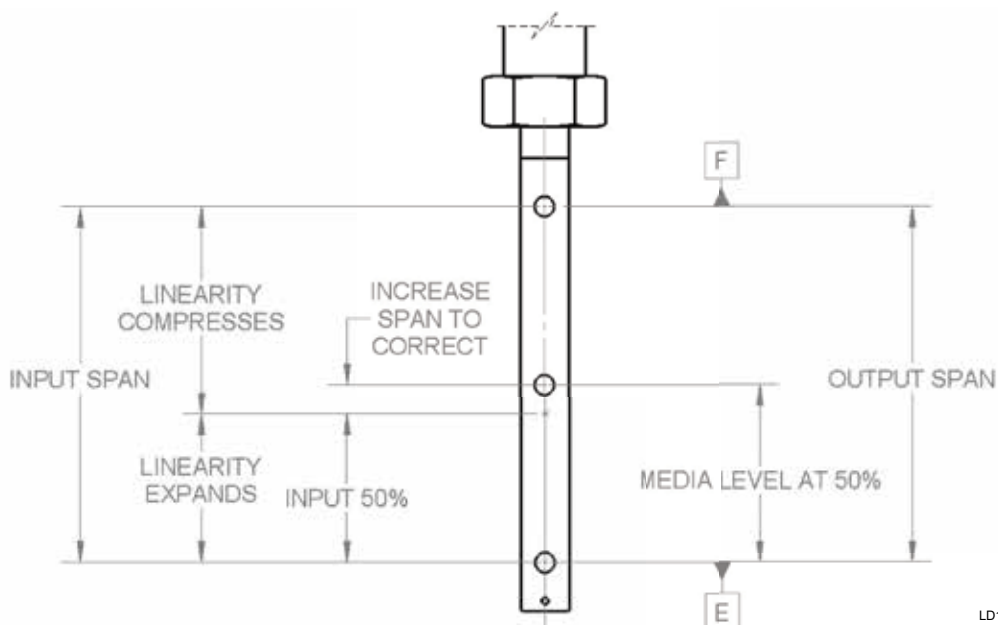

LD17402

FIGURE 30 - MODE L – LINEARITY TUNING

NOTES



P.O. Box 1592, York, Pennsylvania USA 17405-1592
Copyright © by Johnson Controls 2013
Form 50.40-M1 (913)
Issue Date: September 26, 2013
Supersedes 50.40-M1 (813)

800-861-1001
www.johnsoncontrols.com

Subject to change without notice. Printed in USA
ALL RIGHTS RESERVED