

CS02 CAPACITANCE TRANSMITTER

INSTALLATION AND OPERATIONS MANUAL

Continuous Output Transmitter with Advanced Features





READ THIS MANUAL PRIOR TO INSTALLATION

This manual provides information on the **CS02 Capacitance Transmitter**. It is important that all instructions are read carefully and followed sequentially. The **QuickStart Installation** instructions are a brief guide to the sequence of steps for experienced technicians to follow when installing the equipment. Detailed instructions are included in the **Complete Installation** section of this manual.

Conventions Used in this Manual

Certain conventions are used in this manual to convey specific types of information. General technical material, support data and safety information are presented in narrative form. The following styles are used for notes, cautions and warnings:



Notes

Notes contain information that augments or clarifies an operating step. Notes do not normally contain actions and often follow the procedural steps to which they refer.



Cautions

Cautions alert the technician to special conditions that could injure personnel, damage equipment, or reduce a component's mechanical integrity. Cautions are also used to alert the technician of unsafe practices, the need for special protective equipment, or specific materials. In this manual, a caution indicates a potentially hazardous situation which, if not avoided, may result in minor to moderate injury.



Warnings

Warnings identify potentially dangerous situations, or serious hazards. In this manual, a warning indicates an imminently hazardous situation which, if not avoided, may result in serious injury or death.

Safety Messages

Follow all standard industry procedures for servicing electrical and computer equipment when working with, or around high voltage. Always shut off the power supply before touching any components. Although high voltage is not present in this system, it may be present in other systems.

Electrical components are sensitive to electrostatic discharge. To prevent equipment damage, observe all safety precautions when working with electrostatic-sensitive components.



WARNING!

DO NOT CONNECT OR DISCONNECT THE TRANSMITTERS UNLESS THE POWER HAS BEEN SWITCHED OFF.

Low Voltage Directive

If the equipment is used in a manner not specified by the manufacturer, protection provided by equipment may be impaired.

Notice of Copyright and Limitations

Copyright © 2013 Solutions With Innovation, LLC;
All rights reserved.

Solutions With Innovation reserves the right to make changes to the product described in this manual at any time without notice. Solutions With Innovation makes no warranty with respect to the accuracy of the information in this manual.

Warranty

All Solutions With Innovation Electronic Level and Flow Controls are warranted free of defects in materials and workmanship for one full year from the date of the original factory shipment. If returned within the warranty period; and, upon factory inspection of the control, the cause of the claim is determined to be covered under the warranty; then, Solutions With Innovation will repair or replace the product at no cost to the purchaser (or owner) other than transportation.

Solutions With Innovation shall not be liable for misapplication, labor claims, direct or consequential damage, or expenses arising from the installation or use of the equipment. There are no other warranties expressed or implied, except special written warranties covering specific Solutions With Innovation products.

Quality Assurance

The Quality Assurance System in place at Solutions With Innovation guarantees the highest level of quality throughout the company. Solutions With Innovation is committed to providing full customer satisfaction; both in quality products and in quality service.

Contacts

Phone: 203-729-6434 *Mon-Fri, 9 AM - 5 PM EST*
Fax: 203-729-0541 *for General Inquiries*

CS02 CAPACITANCE TRANSMITTER

with Advanced Features

TABLE OF CONTENTS

1.0 Quickstart Installation

1.1 Getting Started.....	4
1.1.1 Equipment and Tools.....	4
1.1.2 Configuration Information.....	4

2.0 Complete Installation

2.1 Unpacking.....	5
2.2 Installation Location.....	5
2.3 Electrostatic Discharge Handling Procedure....	6
2.4 Before You Begin.....	6
2.4.1 Site Preparation.....	6
2.4.2 Equipment and Tools.....	6
2.4.3 Optional Considerations.....	7
2.5 Mounting.....	7
2.5.1 CS02 Probe Installation.....	7
2.6 Wiring.....	8
2.6.1 General Purpose or Non-Incendive.....	8
2.6.2 Intrinsically Safe.....	8
2.7 Overview: Modes of Operation.....	9
2.7.1 Initial Span and Calibration Functions.....	9
2.7.2 Modes for Advanced Performance.....	10
2.7.3 Function Modes.....	10
2.8 Spanning and Calibration.....	11
2.8.1 Calibration.....	11
2.8.2 Basic Modes.....	11-12
2.9 Function Modes.....	12
2.10 Tuning Modes.....	13-16

3.0 Reference Information

3.1 Description.....	17
3.2 Theory of Operation.....	17
3.2.1 Basic Operating Principle.....	17
3.2.2 CS02 Control Board.....	17
3.3 Troubleshooting.....	18
3.3.1 CS02 Transmitter Problems.....	18
3.4 Agency Approvals.....	18
3.5 Output vs. Level Percentage Charts.....	19
3.5.1 4-20 mA Output.....	19
3.5.2 0-5 VDC Output.....	19
3.5.3 1-5 VDC Output.....	19
3.6 Specifications.....	20
3.6.1 Functional.....	20
3.6.2 Process Conditions.....	21
3.6.3 Physical.....	21
3.7 Model Configurator.....	22
3.8 Notes.....	23



1.0 QUICKSTART INSTALLATION

The Quickstart Installation procedures provide key steps for mounting, wiring and configuring the CS02 Capacitance Transmitter. These procedures are intended for experienced installers of electronic level measurement instruments. Refer to **Section 2.0: Complete Installation** for detailed installation instructions.

 **WARNING!** CS02 TRANSMITTER PROBES SHOULD BE INSTALLED WHERE THE MAXIMUM OVERFILL LEVEL IS AT A MINIMUM OF 0.50" (12.7 MM) BELOW THE PROCESS CONNECTION.

1.1 GETTING STARTED

Before beginning the Quickstart Installation procedures, have the proper equipment, tools and information readily available.

1.1.1 Equipment and Tools

- Open-End Wrenches or An Adjustable Wrench to Fit the Process Connection Size and Type
- 1/8" Wide, Small Flat Blade Screwdriver
- Cable Cutter & Wire Strippers
- Digital Multimeter or Digital Volt/Ammeter
- 9 to 45 VDC Power Supply

1.1.2 Configuration Information

The CS02 Capacitance Transmitter is factory-calibrated in water. If other medias are to be used, contact the manufacturer for details. Refer to **Section 2.8** for calibration instructions.

2.0 COMPLETE INSTALLATION

This section provides detailed procedures on properly installing and configuring the CS02 Capacitance Transmitter.

 **CAUTION!** IF THE EQUIPMENT IS USED IN A MANNER NOT SPECIFIED BY THE MANUFACTURER, PROTECTION PROVIDED BY THE EQUIPMENT MAY BE IMPAIRED.

2.1 UNPACKING

Unpack the instrument, carefully. Make sure that all components have been removed from the packing material. Inspect all components for damage. Report any concealed damage to the carrier within 24 hours of receiving. Compare the contents with the packing slip and report any discrepancies to the factory immediately. Record the sales order number and/or serial number for future reference when ordering parts.

Before Proceeding to Installation, Complete the Following:

- Inspect all components for damage. Report any damage to the carrier within 24 hours of receiving.
- Record the model and serial numbers for future reference when ordering parts.

Model Number _____

Serial Number _____

2.2 INSTALLATION LOCATION

CS02 Capacitance Transmitter sensors should be located within easy access for service, calibration and monitoring. Sensors should not be exposed to ambient temperatures below -40°F (-40°C) or above $+185^{\circ}\text{F}$ ($+85^{\circ}\text{C}$). Special precaution should be made to prevent exposure to corrosive atmospheres, excessive vibration, shock and physical damage.

It is common practice to use the metal tank wall as the reference ground. In such cases, it is required that the probe housing makes a good electrical connection to the tank wall. If there is any doubt about this connection due to the use of PTFE thread tape, gaskets, paint, rust or any other reason, a separate strap should be installed between the probe housing and tank.

 **CAUTION!** THIS UNIT CONTAINS ELECTRONICS WHICH MAY BE DAMAGED BY STATIC ELECTRICITY. DO NOT TOUCH ANY SEMI-CONDUCTOR DEVICES UNLESS YOU ARE PROPERLY GROUNDED.

2.3 ⚠ ELECTROSTATIC DISCHARGE (ESD) HANDLING PROCEDURE



Solutions With Innovation's electronic instruments are manufactured to the highest quality standards. These instruments use electronic components that may be damaged by static electricity present in most work environments.

THE FOLLOWING STEPS ARE RECOMMENDED TO REDUCE THE RISK OF COMPONENT FAILURE DUE TO ELECTROSTATIC DISCHARGE:



- Ship and store circuit boards in anti-static bags. If an anti-static bag is not available, wrap the board in aluminum foil. Do not place boards on foam packing materials.
- Use a grounding wrist strap when installing and removing circuit boards. A grounded workstation is recommended.
- Handle all circuit boards *only* by their edges. Do not touch board components or connector pins.
- Make sure that all electrical connections are completely secure and none are partial or floating. Ground all equipment to a good, earth ground.

2.4 BEFORE YOU BEGIN

2.4.1 Site Preparation

- 1 Each CS02 Capacitance Transmitter is built to the specifications indicated during the ordering process. Make sure that the probe connection is correct for the threaded or flanged mounting on the vessel or tank where the transmitter will be placed. Refer to **Section 2.5: Mounting**.
- 2 Ensure that the wiring between the power supply and CS02 electronics are complete and appropriate for the type of installation. Refer to **Section 3.6: Specifications**.
- 3 When installing the CS02 Capacitance Transmitter in a general purpose or non-incendive area, all local, state and federal regulations/guidelines must be observed. Refer to **Section 2.6: Wiring**.

2.4.2 Equipment and Tools

No special equipment or tools are required to install the CS02 Capacitance Transmitter.

The Following Are Recommended:

- Grounding Wrist Strap and ESD Workstation (*For safety usage with electronic components*)
- Open-End Wrenches or an Adjustable Wrench (*To fit the process connection size and type*)
- 1/8" Wide, Small Flat Blade Screwdriver
- Cable Cutter & Wire Strippers
- #2 Phillips Head Screwdriver
- Digital Multimeter or Digital Volt/Ammeter
- 9 to 45 VDC Power Supply

2.4.3 Optional Considerations

Operating specifications vary based on the probe model number. Refer to **Section 3.6: Specifications**.

2.5 MOUNTING

The CS02 Capacitance Transmitter can be mounted vertically inside a tank using a variety of process connections. Generally, a threaded or flanged connection is used. For information about the sizes and types of connections available, refer to **Section 3.7: Model Configurator**.

 **WARNING!** CS02 TRANSMITTER PROBES SHOULD BE INSTALLED WHERE THE MAXIMUM OVERFILL LEVEL IS AT A MINIMUM OF 0.50" (12.7 MM) BELOW THE PROCESS CONNECTION.

 **WARNING!** DO NOT DISASSEMBLE THE PROBE WHEN IT IS IN SERVICE AND/OR UNDER PRESSURE.

2.5.1 CS02 Probe Installation

Before Installing, Verify:

- The probe has adequate room for installation and has an unobstructed entry to the bottom of the vessel. Refer to **Section 3.6.3: Physical Specifications**.
- The process temperature, pressure and specific gravity are within the probe specifications for the installation. Refer to **Section 3.6: Specifications**.

How To Install The CS02 Capacitance Probe:

- 1 Make sure that the process connection is an NPT, sanitary or flanged mounting.
- 2 Carefully, place the probe into the vessel. Align the gasket on flanged installations.
- 3 Align the probe process connection with the threaded or flanged mounting on the vessel.
- 4 For *threaded connections*, tighten the hex nut of the probe process connection.
For *flanged connections*, tighten and torque the flange bolts.

2.6 WIRING

CAUTION! THE CS02 CAPACITANCE TRANSMITTER ELECTRONICS OPERATE AT VOLTAGES OF 9 - 45 VDC. A HIGHER VOLTAGE WILL DAMAGE THE TRANSMITTER.

WARNING! DO NOT DISCONNECT THE EQUIPMENT UNLESS THE POWER IS SWITCHED OFF.

NOTE: WIRING BETWEEN THE POWER SUPPLY AND CS02 ELECTRONICS SHOULD BE MADE USING 18 - 22 AWG HOOK UP WIRE.

2.6.1 General Purpose or Non-Incendive (Class I, Div. II)

- A *General Purpose* installation **DOES NOT** have flammable media present.
- Areas rated *Non-Incendive* (Class I, Div. II) have flammable media present only under abnormal conditions. No special electrical connections are required.
- If flammable media is contained in the vessel, the transmitter must be installed per Class I, Div. II standards of area classification.

How To Install General Purpose or Non-Incendive Wiring:

- 1 Remove the cover of the transmitter.
- 2 Install the conduit plug into the unused opening, if applicable. Install a conduit fitting and pull the supply wires through.
- 3 Connect the positive supply wire to the #1 terminal and the negative supply wire to the #2 terminal.
- 4 Connect the signal wire to the #3 terminal. Then, run the wires to your device to make proper terminations for signal there.
- 5 Re-install the cover of the transmitter.

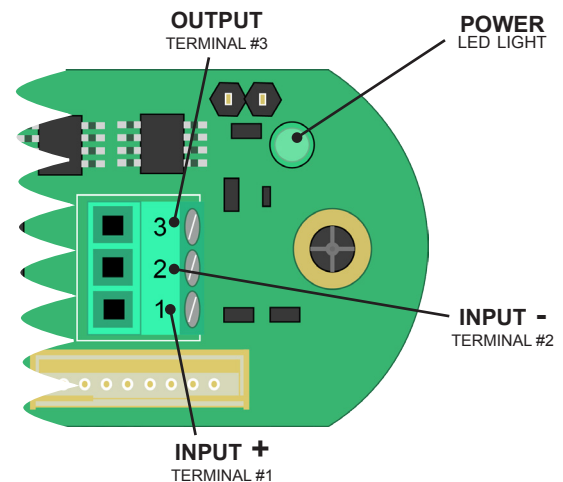

2.6.2 CS02 Intrinsically Safe Wiring

- An *Intrinsically Safe* installation **DOES** have potentially flammable media present.
- An approved intrinsically safe barrier must be installed in the non-hazardous (safe) area.

How To Install Intrinsically Safe Wiring:

- 1 Verify that the intrinsically safe barrier is properly installed in the safe area. Then, complete the wiring from the barrier to the transmitter.
- 2 Remove the cover of the transmitter.
- 3 Install the conduit plug into the unused opening, if applicable. Install a conduit fitting and pull the supply wires through.
- 4 Connect the positive supply wire to the #1 terminal and the negative supply wire to the #2 terminal.
- 5 Connect the signal wire to the #3 terminal. Then, run the wires to your device to make proper terminations for signal there.
- 6 Re-install the cover of the transmitter.

2.7 OVERVIEW: MODES OF OPERATION

2.7.1 Initial Span and Calibration Functions

Modes “0” to “3” are basic sensor setup modes that are programmed prior to leaving the manufacturer. The values for each mode are stored into the default memory location on the device. These values can be recalled at any time by the user after the tuning modifications have been set.



MODE “0” Low Span Value Mode

- 1 By pressing the **UP** and **DOWN** buttons, change the output value for the low-level requirement.
- 2 After establishing the value, press the **SET** button. It will automatically store the low-level span value.



MODE “1” High Span Value Mode

- 1 By pressing the **UP** and **DOWN** buttons, change the output value for the high-level requirement.
- 2 After establishing the value, press the **SET** button. It will automatically store the high-level span value.



MODE “2” Calibration Mode for Low-Level Calibration

- 1 Enable Mode “2” at the liquid level where the probe’s “Empty” condition will occur.
- 2 After establishing the level, press the **SET** button. It will automatically store the low-level calibration value. *The existing default value will be overwritten.*



MODE “3” Calibration Mode for High-Level Calibration

- 1 Enable Mode “3” at the liquid level where the probe’s “Full” condition will occur.
- 2 After establishing the level, press the **SET** button. It will automatically store the high-level calibration value. *The existing default value will be overwritten.*

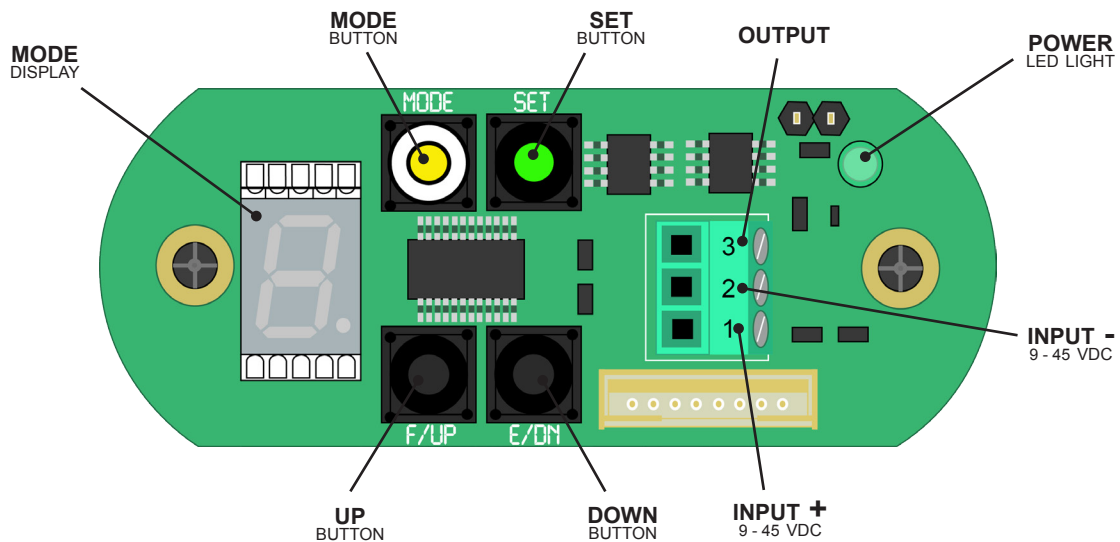

2.7.2 Modes for Advanced Performance

Modes “4” through “9” and “L” are advanced operation modes that are performed in the intended final application. At least two liquid levels will be needed in order to use these modes. Advanced operation modes are extremely useful in media environments where there are changing conditions within the vessel, electronics are replaced into an existing probe, or very accurate span and linear values are needed. *It is important to remember that the output value shown during these tuning modes represents the last liquid level measurement taken.* The tuning outputs represent what the device will read once it is returned to the **RUN** mode.



MODE “4” Resolution Mode:

Ten different resolutions can be accessed as sub-modes. On the display, the sub-mode digit will end with a period (.) as to remain separate from the main modes.



MODE “5” 50% Tuning Mode:

This mode allows the end user to set the pre-determined 50% output value at the exact midpoint on the probe while submerged in the 50% media level.



MODE “6” Span Shifting Mode:

This is similar to Mode “5”, yet it can be utilized at any media level. It allows the end user to incrementally shift the input span length toward a known point and output on the probe.



MODE “7” Span Shifting Mode:

This is similar to Mode “6”. It is meant for use when the low-level output is correct, but the other levels are not. It allows the end user to incrementally increase or decrease the input span length toward a known point and output on the probe.



MODE “8” Span Shifting Mode:

This is similar to Mode “7”. It is meant for use when the high-level output is correct, but the other levels are not. It allows the end user to incrementally increase or decrease the input span length toward a known point and output on the probe.



MODE “9” Span Shifting Mode:

This is similar to Modes “7” and “8”. It is meant for use when the midpoint (50%) level is correct, but the high and low-levels are not. It allows the end user to perform a symmetrical incremental increase or decrease of the input span length toward a known point and output on the probe.



MODE “L” Linearity Mode:

This mode allows the user to adjust the linearity of the output readings to the desired output at any given point on the probe except for high and low-levels.

2.7.3 Function Modes

Function modes are operation modes that allow the end user to return to the default calibration, view the program version and return to the **RUN** mode.



MODE “F” Reset Mode:

This mode resets the sensor to the original calibration values. If the calibration has been changed by the user, it will go back to the last known calibration values.



MODE “P” Version Mode:

This mode will show the most current software version installed on the device.



MODE “R” Run Mode:

This mode enables the device to operate normally. (It is represented as an “A” on the digital display.)

2.8 SPANNING AND CALIBRATION

2.8.1 Calibration

The CS02 Capacitance Transmitter requires minimal to no initial calibration depending on the media. The device is shipped from the manufacturer with its 0% level set on empty indication and its 100% level set on full indication. All devices have been calibrated and validated to function in water, unless another media was specified during the ordering process.

2.8.2 Basic Modes

The CS02 Capacitance Transmitter outputs either a 4-20 mA, 0-5 VDC or 1-5 VDC signal depending on the model selected. Before proceeding to the basic modes, set up the device by connecting a multimeter to verify the output readings.

Initial Device Setup:

- 1 Connect the sensor to a 9-45 VDC power supply.
- 2 A green LED will illuminate on the PCB to indicate that the board is powered up.
- 3 Connect a multimeter to terminals #2 and #3 on the PCB.

Basic Calibration Modes:

- MODE "0"** Set Span Low
(*Output Reading at EMPTY*)
- MODE "1"** Set Span High
(*Output Reading at FULL*)
- MODE "2"** Calibration Low
(*Calibration Point at EMPTY*)
- MODE "3"** Calibration High
(*Calibration Point at FULL*)

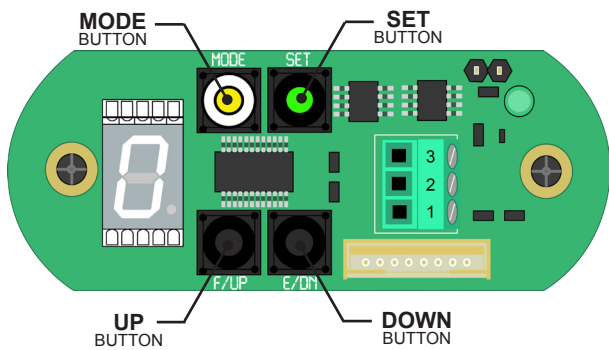

Set Span Low (MODE "0")

- 1 Press the **MODE** button until a "0" is illuminated in the digital display.
- 2 Toggle the **UP** and **DOWN** buttons to set the low span parameter.
- 3 Press the **SET** button. The mode will automatically switch to the next mode, Mode "1".

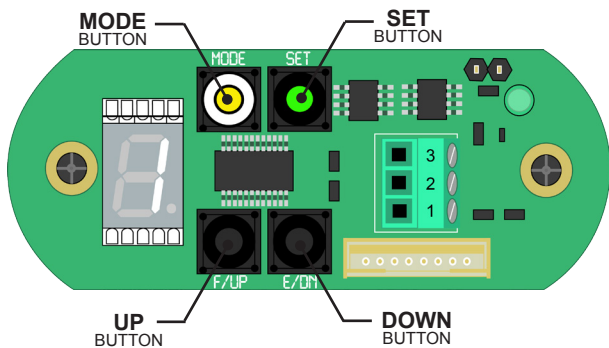

Set Span High (MODE "1")

- 1 Press the **MODE** button until a "1" is illuminated in the digital display, if necessary.
- 2 Toggle the **UP** and **DOWN** buttons to set the high span parameter.
- 3 Press the **SET** button. The mode will automatically switch to the next mode, Mode "2".

2.8.2 Basic Modes (Continued)

In order to calibrate the sensor, the application media should be used. During the calibration process, you will need to raise and lower the media level to the desired **EMPTY** and **FULL** locations on the sensor probe.

Calibrate Low Level (MODE “2”)

- 1 Press the **MODE** button until a “2” is illuminated in the digital display, if necessary.
- 2 Position the media level to the desired **EMPTY** location on the sensor probe.
- 3 Press the **SET** button. The mode will automatically switch to the next mode, Mode “3”.

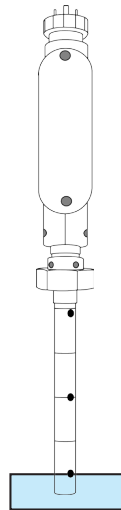
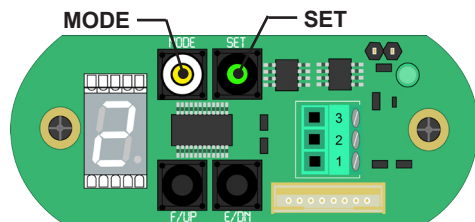

Probe submerged at an EMPTY setpoint.

Calibrate High Level (MODE “3”)

- 1 Press the **MODE** button until a “3” is illuminated in the digital display, if necessary.
- 2 Position the media level to the desired **FULL** location on the sensor probe.
- 3 Press the **SET** button. The mode will automatically switch to the next mode, Mode “4”.

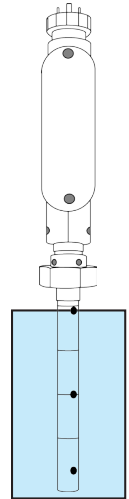
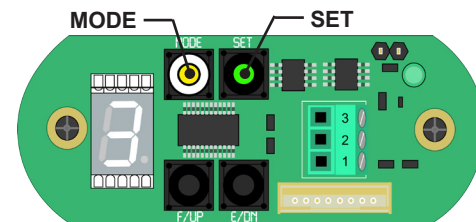

Probe submerged at a FULL setpoint.

2.9 FUNCTION MODES



NOTE: THE FUNCTION MODES DO NOT AFFECT THE SPAN, CALIBRATION OR ADVANCED TUNING FUNCTIONS.

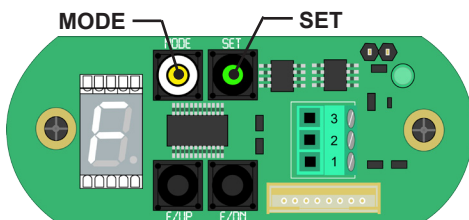

MODE “F” Reset Calibration to Last Known Settings

- 1 Press the **MODE** button until an “F” is illuminated in the display.
- 2 Press the **SET** button to reset the calibration.

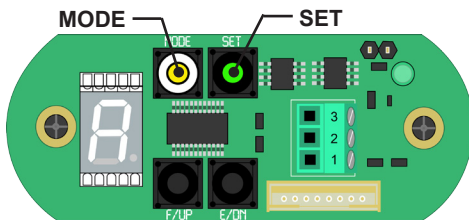

MODE “R” Set Sensor to “RUN” Mode

- 1 Press the **MODE** button until an “R” is illuminated in the display.
- 2 After a second, the display will turn off and then the sensor will be in **RUN** mode.

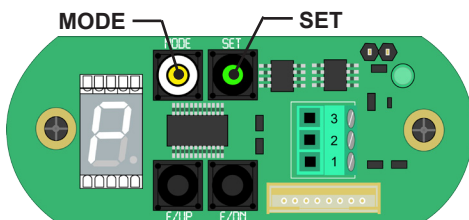

MODE “P” View Current Program Version

- 1 Press the **MODE** button until an “P” is illuminated in the display.
- 2 Press the **SET** button to reset the calibration. The program version will appear in the digital display.

2.10 TUNING MODES

The tuning modes enable the end user to adjust various aspects of the output readings in correlation to the media level on the probe. The user can adjust the readings to obtain perfect output linearity in any given application. **In all cases, it is advised to have a multimeter attached to the #2 negative ground and #3 signal terminal while performing these adjustments.**

NOTE: FOR ALL OF THE FOLLOWING EXAMPLES, THE TERM “INPUT SPAN” WILL BE USED. THIS CORRELATES TO THE CALIBRATED INPUT LEVELS AND NOT TO THE SPAN OUTPUT (I.E. 4-20 mA, 0-5 VDC OR 1-5 VDC). THE INPUT SPAN IS DETERMINED UPON THE CALIBRATION OF THE SENSOR. IN THE FOLLOWING EXAMPLES, CHANGES WILL BE MADE TO THE OPERATIONAL VALUES OF THE SPAN.

Resolution (MODE “4”)

The resolution mode allows the end user to make fine adjustments to the sensitivity of the output change (relative to the change in media level). This feature is beneficial in applications that have an oscillating or turbulent liquid level within the process vessel.

- 1 Press the **MODE** button until a “4” is illuminated in the digital display. The default settings for the resolution are 1024 points over the span length.
Resolution (in.) = Span Length/1024

Resolution Sub-Mode Digit Legend

SUB-MODE	RESOLUTION
0.	DEFAULT
1.	0.062”
2.	0.093”
3.	0.125”
4.	0.156”
5.	0.187”
6.	0.219”
7.	0.250”

- 2 Toggle the **UP** and **DOWN** buttons to achieve the display digit representing the desired resolution. On the digital display, the sub-mode digit will end with a period (.) as to not confuse them with the main modes. Sub-modes provide an exact inch resolution.
- 3 Press the **SET** button to apply the selected resolution.

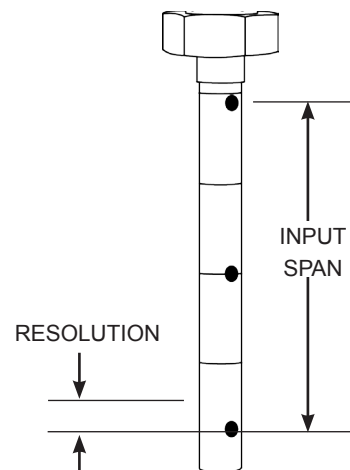
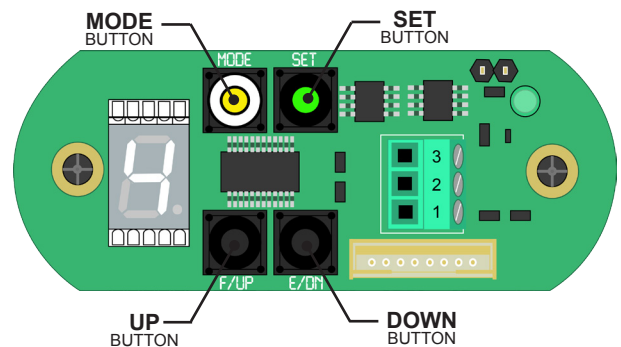

2.10 TUNING MODES (CONTINUED)

Fifty Percent (50%) Tuning (MODE "5")

The 50% tuning mode allows the end user to set the pre-determined 50% output value to the exact probe midpoint while submerged in the media level. For instance, if the media level is at the 50% point on the probe, yet the output reading deviates from the configuration's expected output, then employing Mode "5" will set the output value to the correct amount.

- 1 Press the **MODE** button until a "5" is illuminated in the digital display.
- 2 Press the **SET** button. The sensor is now adjusted to the proper output.

 **NOTE:** AN APPLICATION HAS A MEDIA THAT IS PRONE TO A DIELECTRIC CHANGE WITH TEMPERATURE CHANGE. THE MEDIA LEVEL IS SET AT 50% OF THE PROBE SPAN. IN A 4-20 mA OUTPUT SENSOR, THE EXPECTED OUTPUT CURRENT SHOULD BE 12 mA, HOWEVER, THE ACTUAL OUTPUT READING IS 11.4 mA. BY USING MODE "5", THE OUTPUT WILL BE ADJUSTED TO 12 mA WHILE RETAINING BOTH LINEARITY AND INPUT SPAN LENGTH. THERE MAY BE THE NEED TO MAKE ADDITIONAL CHANGES TO THE INPUT SPAN LENGTH. THIS IS COVERED IN THE FOLLOWING SECTIONS.

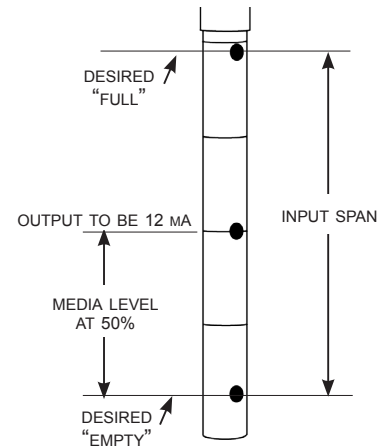
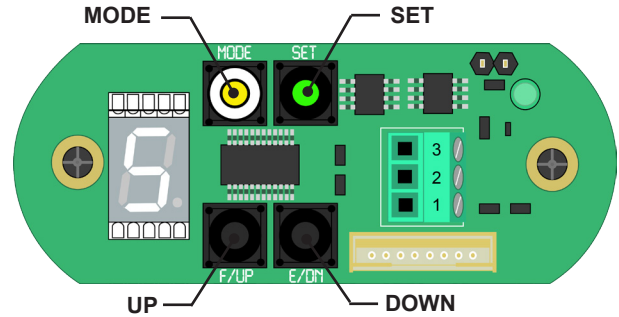

Span Shifting (MODE "6")

The span shifting mode is similar to Mode "5", yet it can be utilized at any given level by employing the **UP** and **DOWN** buttons. Mode "6" allows the end user to incrementally shift the input span length toward a known point and output on the probe. This mode is useful when Mode "5" cannot be performed (i.e. Mode "5" cannot be viewed in the application).

- 1 Press the **MODE** button until a "6" is illuminated in the digital display.
- 2 Toggle the **UP** and **DOWN** buttons to achieve the desired output relative to the media level on the probe.
- 3 Press the **SET** button. The sensor is now adjusted to the proper output for the media level.

 **NOTE:** AN APPLICATION HAS A MEDIA THAT IS PRONE TO A DIELECTRIC CHANGE WITH TEMPERATURE CHANGE. THE MEDIA LEVEL IS AT 25% OF THE PROBE SPAN. IN A 4-20 mA OUTPUT SENSOR, THE EXPECTED OUTPUT CURRENT SHOULD BE 8 mA, HOWEVER, THE ACTUAL OUTPUT READING IS 10.6 mA. BY USING MODE "6", THE OUTPUT CAN BE ADJUSTED TO 8 mA WHILE RETAINING BOTH LINEARITY AND INPUT SPAN LENGTH. THERE MAY BE THE NEED TO MAKE ADDITIONAL CHANGES TO THE INPUT SPAN LENGTH. THIS IS COVERED IN THE FOLLOWING SECTIONS.

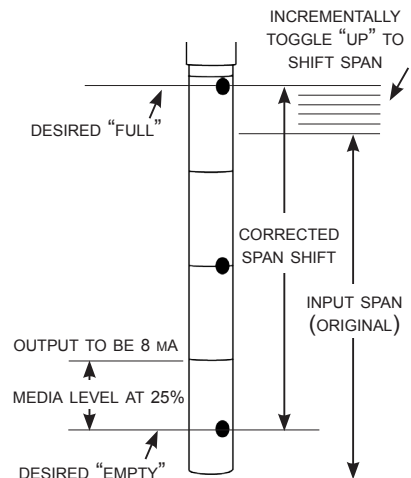
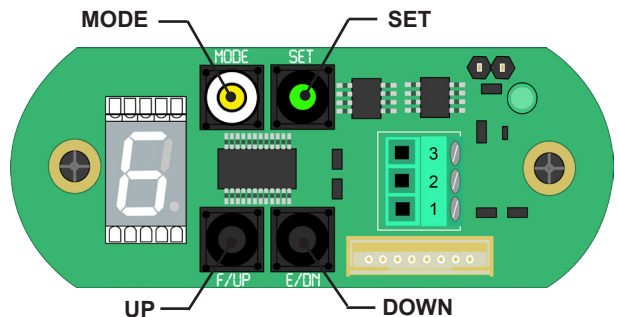

Increase/Decrease Span from Low (MODE “7”)

Mode “7” allows the end user to change the input span length when the low-level output is correct, but all the other levels are not. The user can incrementally increase or decrease the input span length toward a known point or output on the probe. Mode “7” is useful when the 100% level cannot be viewed in the application.

- 1 Press the **MODE** button until a “7” is illuminated in the digital display.
- 2 Toggle the **UP** and **DOWN** buttons to achieve the desired output relative to the media level on the probe.
- 3 Press the **SET** button. The sensor is now adjusted to the proper output for the media level.

 **NOTE:** AN APPLICATION SHOWS THAT THE MAXIMUM OUTPUT IS BEING OBTAINED BEFORE THE MEDIA CAN REACH THE INTENDED HIGH LEVEL. CURRENTLY, THE MEDIA LEVEL IS AT 50% OF THE PROBE SPAN. IN A 4-20 mA OUTPUT SENSOR, THE EXPECTED OUTPUT SHOULD BE 12 mA, HOWEVER, THE ACTUAL OUTPUT READING IS 14.8 mA. THROUGH THE USE OF MODE “7”, THE OUTPUT CAN BE ADJUSTED DOWN TO 12 mA BY TOGGING THE UP AND DOWN BUTTONS. THE LINEARITY WILL BE RETAINED, BUT THE INPUT SPAN LENGTH WILL CHANGE.

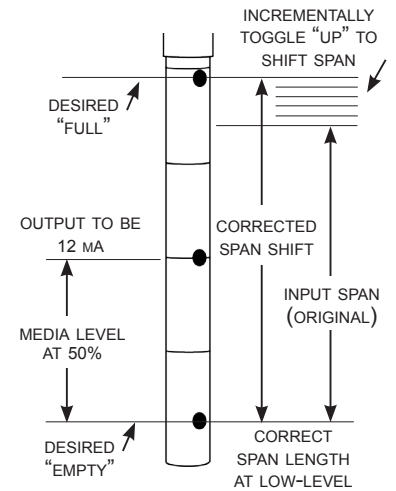
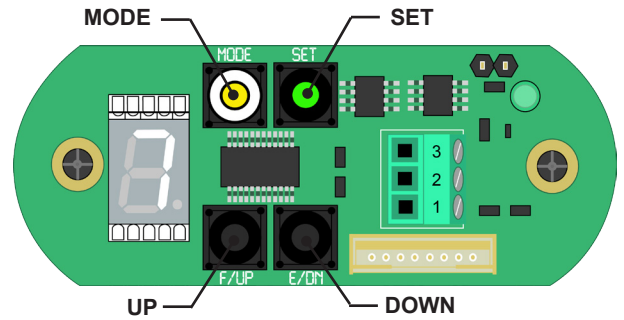

Increase/Decrease Span from High (MODE “8”)

Mode “8” is similar to Mode “7” by allowing the end user to change the input span length when the high-level output is correct, yet all the other levels are not. The user can incrementally increase or decrease the input span length toward a known point or output on the probe. Mode “8” is useful when the 0% level cannot be viewed in the application.

- 1 Press the **MODE** button until a “8” is illuminated in the digital display.
- 2 Toggle the **UP** and **DOWN** buttons to achieve the desired output relative to the media level on the probe.
- 3 Press the **SET** button. The sensor is now adjusted to the proper output for the media level.

 **NOTE:** AN APPLICATION SHOWS THAT THE MINIMUM OUTPUT IS BEING OBTAINED BEFORE THE MEDIA CAN REACH THE INTENDED HIGH LEVEL. CURRENTLY, THE MEDIA LEVEL IS AT 50% OF THE PROBE SPAN. IN A 4-20 mA OUTPUT SENSOR, THE EXPECTED OUTPUT SHOULD BE 12 mA, HOWEVER, THE ACTUAL OUTPUT READING IS 9.5 mA. THROUGH THE USE OF MODE “8”, THE OUTPUT CAN BE ADJUSTED UP TO 12 mA BY TOGGING THE UP AND DOWN BUTTONS. THE LINEARITY WILL BE RETAINED, BUT THE INPUT SPAN LENGTH WILL CHANGE.

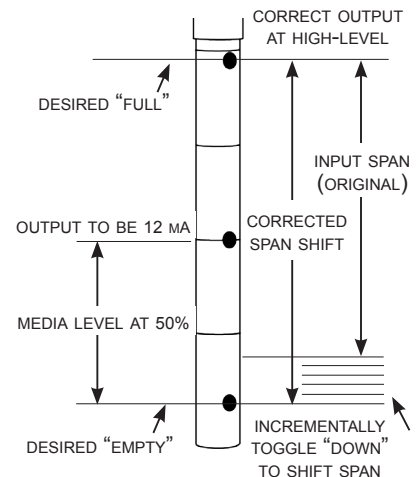
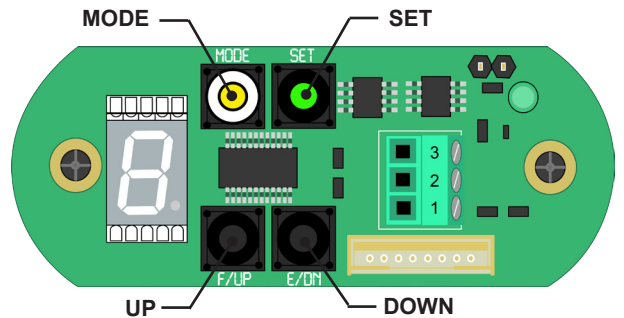

2.10 TUNING MODES (CONTINUED)

Increase/Decrease Span from Midpoint 50% (MODE “9”)

Mode “9” is similar to Modes “7” and “8” by allowing the end user to change the input span length when the midpoint (50%) output is correct, yet all the other high and low levels are not. The user can perform a symmetrical incremental increase or decrease of the input span length toward a known point and output on the probe. Mode “9” is useful when the entire probe can be viewed in the application.

- 1 Press the **MODE** button until a “9” is illuminated in the digital display.
- 2 Toggle the **UP** and **DOWN** buttons to achieve the desired output relative to the media level on the probe.
- 3 Press the **SET** button. The sensor is now adjusted to the proper output for the media level.

NOTE: AN APPLICATION SHOWS THAT THE MIN. AND MAX. OUTPUTS ARE BEING ATTAINED BEFORE THE MEDIA CAN REACH THE INTENDED HIGH AND LOW LEVELS. IN A 4-20 mA OUTPUT SENSOR, THE EXPECTED OUTPUT READING AT 50% IS 12 mA. THE ACTUAL OUTPUT IS 12 mA, BUT THE OUTPUT READS “EMPTY” OR “FULL” BEFORE THOSE LEVELS ARE OBTAINED. THROUGH THE USE OF MODE “9”, THE OUTPUT CAN BE ADJUSTED SYMMETRICALLY TO ATTAIN THE CORRECT HIGH AND LOW OUTPUTS BY TOGGING THE UP AND DOWN BUTTONS. THE LINEARITY WILL BE RETAINED, BUT THE INPUT SPAN LENGTH WILL CHANGE.

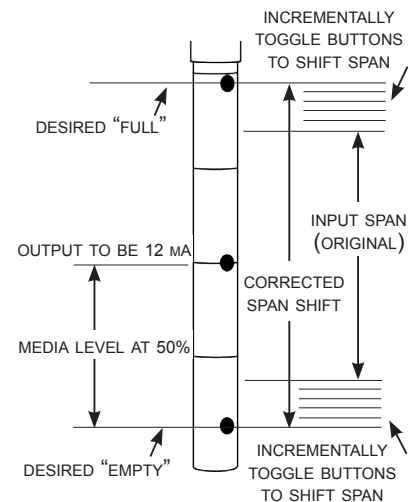
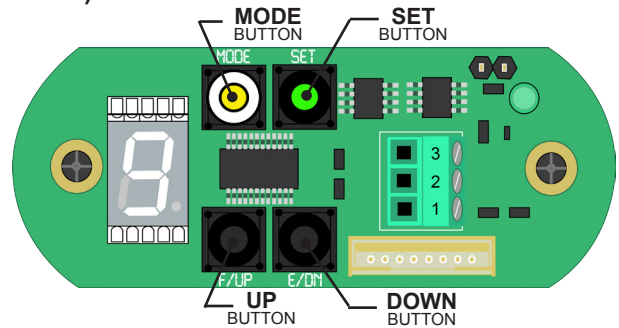

Linearity Tuning (MODE “L”)

Mode “L” allows the user to adjust the linearity of the output readings to a desired output at any given point on the probe (excluding the high and low-levels). This mode is useful when the entire probe can be viewed in the application. *High and low-level outputs should be known to be correct.*

- 1 Press the **MODE** button until an “L” is illuminated in the digital display.
- 2 Toggle the **UP** and **DOWN** buttons to achieve the desired output relative to the media level on the probe.
- 3 Press the **SET** button. The sensor is now adjusted to the proper output for the media level.

NOTE: AN APPLICATION SHOWS THAT THE OUTPUT IS CORRECT AT THE MAXIMUM AND MINIMUM LEVELS, BUT THE 50% OUTPUT ON THE 4-20 mA SENSOR READS 11.1 mA WHEN IT SHOULD BE 12 mA. THROUGH THE USE OF MODE “L”, THE LINEARITY OF THE OUTPUT CAN BE ADJUSTED BY TOGGING THE UP AND DOWN BUTTONS. THE LINEARITY WILL CHANGE, BUT THE INPUT SPAN LENGTH IS RETAINED.

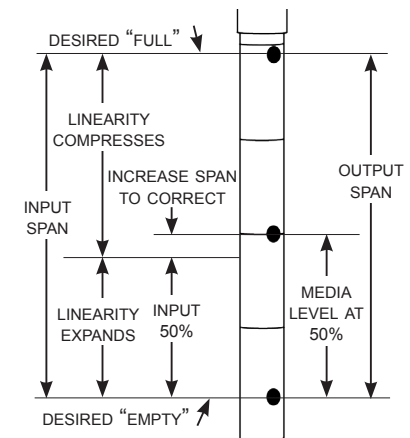
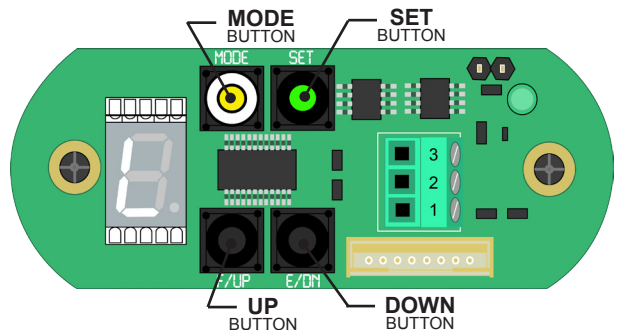

3.0 REFERENCE INFORMATION

This section illustrates an overview of the CS02 Capacitance Transmitter operation, as well as information on troubleshooting common problems, agency approval listings, replacement parts, and detailed physical, functional and performance specifications.

3.1 DESCRIPTION

The CS02 Capacitance Transmitter is designed to detect the fluid levels of liquids in various applications. The CS02 eliminates the need for an input voltage jumper, enabling the user to change the power supply voltage within a factory-set, 9 to 45 VDC range. Output signals are available in 4-20 mA, 0-5 VDC and 1-5 VDC, depending on the application. All models are equipped with durable, die-cast aluminum enclosures and 316 stainless steel sensing probes. A variety of mounting sizes and probe lengths are made to order. Optional internal sheath materials include Kynar, PFA or PEEK.

3.2 THEORY OF OPERATION

3.2.1 Basic Operating Principle

Capacitance-based level measurements were founded on a time proven method utilizing stationary parts. The operation of a capacitance level control is based on the simple electronic component—the capacitor. A capacitor is an electric component used for storing energy. It is important to note that capacitance level controls do not store energy within the probe. Instead, they measure the amount of energy that can be stored. The unit of measurement for capacitance is the “farad”, however, in capacitance level measurements, relatively small amounts are present and measured in “picofarads” (1×10^{-12} farads).

In order for a capacitor to function, the media between the plates must serve as an insulator. If a conductive material is placed between the plates, an electrical “short” will occur. As a result, the capacitor is comprised of a metal probe rod and outer shield (serving as the conductive plates) around the insulating, dielectric media.

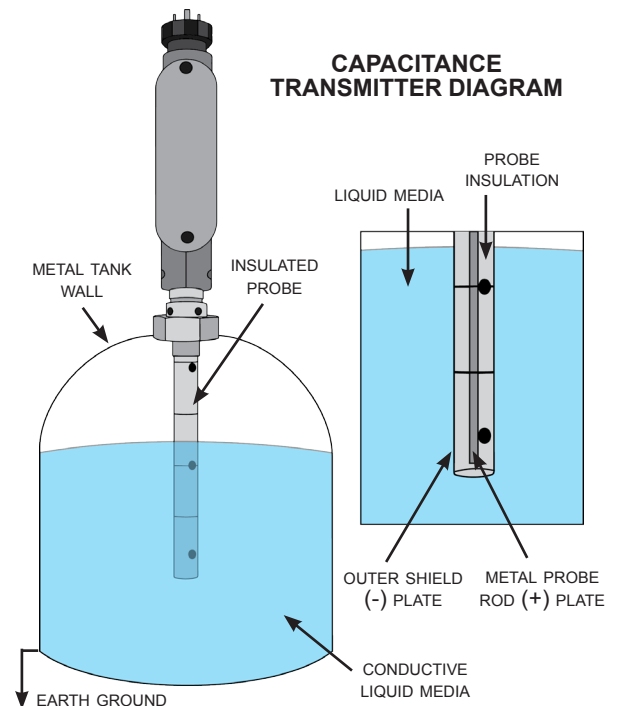

3.2.2 CS02 Control Board

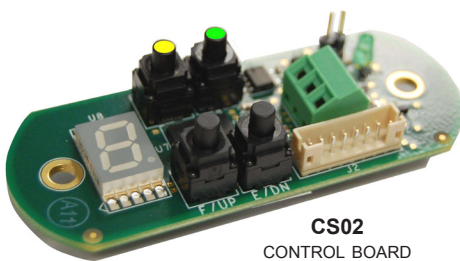

The CS02 control board is a current or voltage transmitter that receives capacitance inputs from the center probe and directly converts the information to a current or DC voltage output signal. The CS02 series eliminates the need for an input voltage jumper and as a result, the user can adjust the power supply input voltage between 9 and 45 VDC for operation.

- The input voltage is factory-set for a range of 9 to 45 VDC.
- The output signal is available in 4-20 mA, 0-5 VDC or 1-5 VDC, depending on the intended application.

3.3 TROUBLESHOOTING

The CS02 Capacitance Transmitter is designed and manufactured for trouble-free performance across a wide range of operating conditions. Common transmitter problems are discussed in terms of their symptoms and recommended corrective actions. Information on how to handle material build-up on the probe is also provided in this section.



⚠ WARNING! EXPLOSION HAZARD. DO NOT CONNECT OR DISCONNECT THE EQUIPMENT UNLESS POWER HAS BEEN SWITCHED OFF OR THE AREA IS KNOWN TO BE NON-HAZARDOUS.

3.3.1 CS02 Transmitter Problems

SYMPTOM	PROBLEM	SOLUTION
THE OUTPUT IS INACCURATE.	THE CALIBRATION IS QUESTIONABLE.	RECALIBRATE THE TRANSMITTER AND USE THE ADVANCED TUNING MODES.
THE OUTPUT IS REPETITIVE, BUT IT IS CONSISTENTLY HIGH OR LOW FROM THE ACTUAL OUTPUT BY A FIXED AMOUNT.	THE CALIBRATION IS QUESTIONABLE.	RECALIBRATE THE TRANSMITTER AND USE THE ADVANCED TUNING MODES.
THE OUTPUT FLUCTUATES.	TURBULENCE.	CHANGE THE RESOLUTION TO A LARGER INCH INCREMENT.
THE OUTPUT READING IS LOW VERSUS THE ACTUAL OUTPUT.	COATING OR BUILD-UP IS PRESENT ON THE PROBE.	CLEAR THE PROBE OF ANY CONTAMINANTS.
THE OUTPUT READING IS LOW VERSUS THE ACTUAL OUTPUT.	COATING, CLUMPING OR BUILD-UP IS PRESENT IN THE SHIELD FLOW HOLES.	CLEAR THE SHIELD HOLES OF ANY CONTAMINANTS AND USE THE ADVANCED TUNING MODES, IF NECESSARY.

 *If you are still in doubt about the condition or performance of your control, consult the factory for further instructions.*

3.4 AGENCY APPROVALS

AGENCY	APPROVED MODEL(S)	FILE NUMBER	AREA CLASSIFICATION
UL 	CS02	E322721, VOL. 1	NKCR2/8 RECOGNIZED
CE 	CS02	F2LQ5171B-01E	EN 61326-1:2006 EN 55011:2009

3.5 OUTPUT VS. LEVEL PERCENTAGE CHARTS

This section provides the user with information regarding the expected output signals at given percentages of media coverage on the sensing probe. The signal outputs are proportional 4-20 mA, 0-5 VDC or 1-5 VDC outputs, depending on the model configuration.

3.5.1 4-20 mA Output

4-20 mA OUTPUT CHART

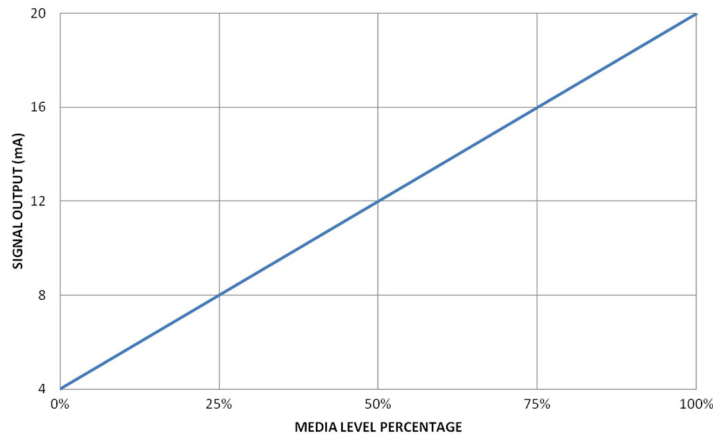

4-20 mA OUTPUT AT FLUID LEVELS

MEDIA LEVEL	OUTPUT
100%	20.00 mA
75%	16.00 mA
50%	12.00 mA
25%	8.00 mA
0%	4.00 mA

3.5.2 0-5 VDC Output

0-5 VDC OUTPUT CHART

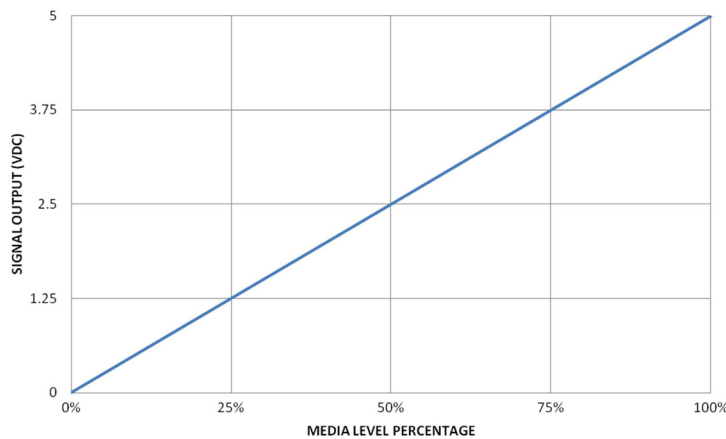

0-5 VDC OUTPUT AT FLUID LEVELS

MEDIA LEVEL	OUTPUT
100%	5.00 VDC
75%	3.75 VDC
50%	2.50 VDC
25%	1.25 VDC
0%	0.00 VDC

3.5.3 1-5 VDC Output

1-5 VDC OUTPUT CHART

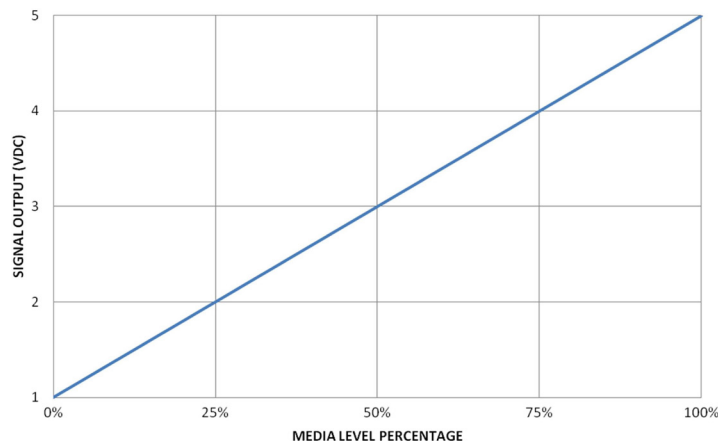

1-5 VDC OUTPUT AT FLUID LEVELS

MEDIA LEVEL	OUTPUT
100%	5.00 VDC
75%	4.00 VDC
50%	3.00 VDC
25%	2.00 VDC
0%	1.00 VDC

3.6 SPECIFICATIONS

3.6.1 Functional

INPUT	
MEASUREMENT PRINCIPLE:	Capacitance Change Converted to Output Signal
MEASURED VARIABLE:	Capacitance Level, Determined by the Media Level on the Probe and a Proportionally Conditioned Output Signal
INDICATION LENGTH:	4" to 180" (10 cm to 458 cm)
POWER:	9 to 45 VDC
WIRING TERMINAL:	3 Positions: 2 Input, 1 Output
OUTPUT	
SIGNAL:	4-20 mA, 0-5 VDC or 1-5 VDC (Analog)
RANGE:	0 to 24 mA <i>Usable</i> , or 0 to 5.5 VDC <i>Usable</i> (Analog)
RESOLUTION:	1024 Points Over Span (Default), 0.062", 0.094", 0.125", 0.156", 0.187", 0.219", 0.250" (Analog)
ENVIRONMENTAL	
OPERATING TEMPERATURE:	-20° to +185° F (-29° to +85° C)
STORAGE TEMPERATURE:	-50° to +175° F (-40° to +80° C)
AMBIENT TEMPERATURE:	Approximately +0.03% of Probe Length/°C
HUMIDITY:	0 to 99%, Non-Condensing
VIBRATION CLASS:	ANSI/ISA-S71.03 Class VC2
MAXIMUM PRESSURE:	See Section 3.6.2: Process Conditions
USER INTERFACE	
PUSH-BUTTON:	Yes (4)
INDICATION:	(1) LED Power Light
MODE INDICATION:	(1) One-Digit LED Display
PERFORMANCE	
LINEARITY:	± 0.50%
REPEATABILITY:	> 96%
RESPONSE TIME:	Less Than 1 Second
WARM-UP TIME:	Less Than 3 Seconds
MATERIALS OF CONSTRUCTION	
ENCLOSURE:	Die-Cast Aluminum, Gray Powder Coat Finish
PROBE MOUNT & SHIELD:	316 Stainless Steel
PROCESS CONNECTION:	See Section 3.7: Model Numbers
SHEATH INSULATION:	Kynar, PFA or PEEK (To Suit Process Media)

3.6.2 Process Conditions

CS02 CAPACITANCE PROBES

MAXIMUM PROCESS TEMPERATURE: +280° F at 150 PSIG (+138° C at 10 bar)

MAXIMUM PROCESS PRESSURE: 500 PSIG at +70° F (51.7 bar at +20° C)

CS02: RF NOISE IMMUNITY TEST RESULTS

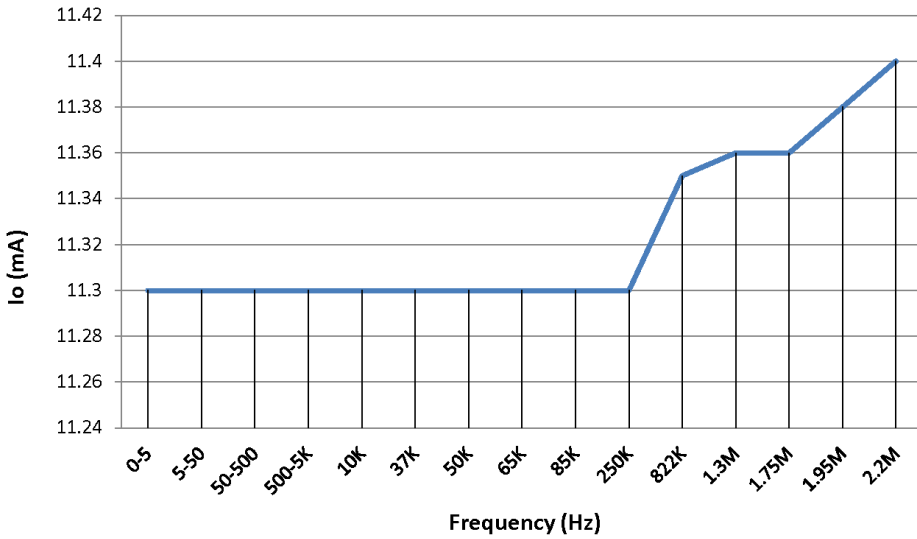

FREQUENCY: F (Hz)	CURRENT: Io (mA)
0-5	11.3
5-50	11.3
50-500	11.3
500-5K	11.3
10K	11.3
37K	11.3
50K	11.3
65K	11.3
85K	11.3
250K	11.3
822K	11.35
1.3M	11.36
1.75M	11.36
1.95M	11.38
2.2M	11.4

3.6.3 Physical

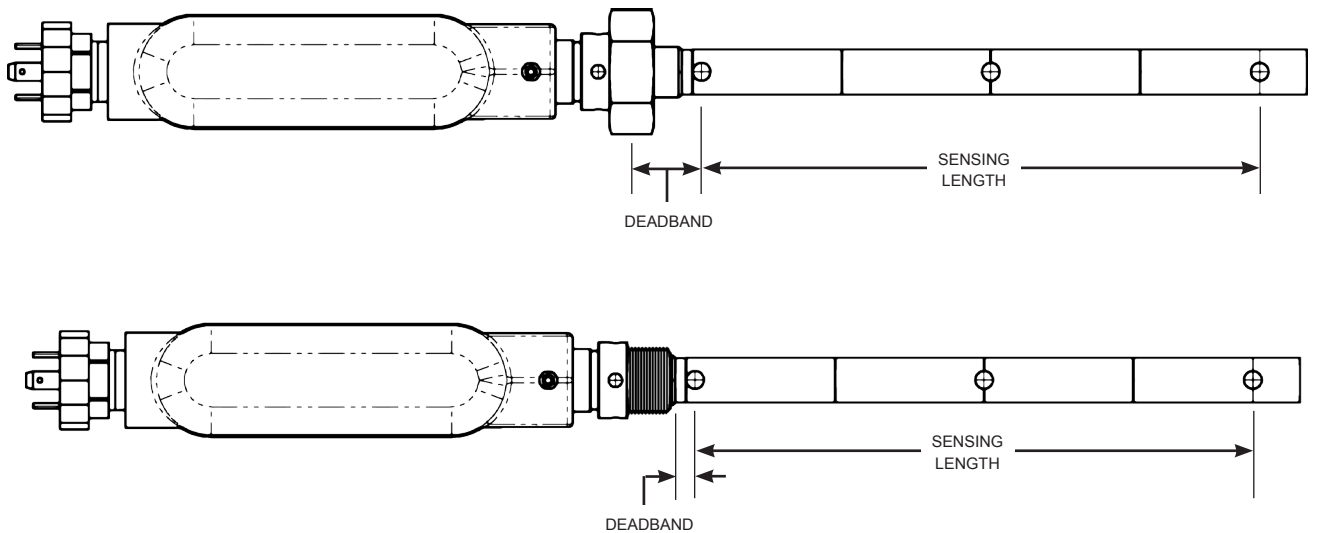

3.7 MODEL CONFIGURATOR

TECHNOLOGY		MODEL		CONFIG.		MOUNTING		MOUNT MAT'L		INDICATION LENGTH		DEADBAND LENGTH		SHEATH	
CS	Capacitance Transmitter	02	2 nd Gen.	-	Standard	00	No Mount (Used with Compression Fitting)**	08	316 S.S.	XXX.XX	Full Inches (120.50")	XX.XX	Full Inches (05.25")	04	Kynar
				C	Custom	04	½" NPT							50	PFA
						05	¾" NPT							60	PEEK
						06	1" NPT								
						07	1 ¼" NPT								
						08	1 ½" NPT								
						09	2" NPT								
						10	3" NPT								
						11	4" NPT								
						12	2 ½" NPT								
						64	2 ½" Sanitary Flange								
						65	3" Sanitary Flange								
						66	4" Sanitary Flange								
						72	1 ½" #150 ANSI Flange								
						73	2" #150 ANSI Flange								
						74	2 ½" #150 ANSI Flange								
						75	3" #150 ANSI Flange								
						76	4" #150 ANSI Flange								
						83	1 ½" #300 ANSI Flange								
						84	2" #300 ANSI Flange								
						85	2 ½" #300 ANSI Flange								
						86	3" #300 ANSI Flange								
						87	4" #300 ANSI Flange								
						98	Roto-Lock								

When Ordering:

Please specify the desired output type (4-20 mA, 0-5 VDC or 1-5 VDC) and the application media. Various enclosure options are available. Call the manufacturer for details: **203-729-6434**.

****PRESSURE RATING MAY BE AFFECTED.**

3.8 NOTES

ASSURED QUALITY & SERVICE COST LESS

Service Policy

Owners of Solutions With Innovation products may request a return of the product, or any part of the product for complete rebuilding or replacement. Units will be rebuilt or replaced promptly. Products returned under the SWI Service Policy must be returned by prepaid transportation. Solutions With Innovation will repair or replace the product at no cost to the purchaser (or owner) other than transportation if:

- 1 Returned within the warranty period; and
- 2 Factory Inspection finds the cause of the claim to be covered under the warranty.

If the problem is due to circumstances beyond Solutions With Innovation's liability, or is NOT covered by the warranty, there will be charges for labor in addition to the parts required to rebuild or replace the equipment.

In rare cases, it may be expedient to ship replacement parts; or in extreme cases, an entire product before the damaged product is returned. If a quick replacement service is necessary, notify the manufacturer of the damaged product's model and serial number. In such cases, credit for the returned materials will be determined on the applicability of the warranty.

No claims for misapplication, labor, direct or consequential damage will be allowed.

Return Material Procedure

In order to efficiently process any returned materials, it is essential that a *Return Material Authorization* (RMA) number be obtained from the manufacturer prior to an item's return. RMA's can be issued through local representatives, or by contacting the factory directly.

Please supply the following information:

- 1 The Company's Name
- 2 Description of the Material
- 3 Product Serial Number
- 4 Reason for Return
- 5 Product's Application

Used units must be properly cleaned in accordance with OSHA standards before it is returned to the manufacturer. A *Material Safety Data Sheet* (MSDS) must accompany units or materials that were used in any type of media. All return shipments to the factory must be by done via prepaid transportation. All product replacements will be shipped F.O.B. manufacturer.



BULLETIN: IS-0990.2
EFFECTIVE: 11/13

WWW.SOLUTIONSWITHINNOVATION.COM



60 GREAT HILL ROAD • NAUGATUCK, CT 06770 • TEL: 203-729-6434 • FAX: 203-729-0541 • EMAIL: INFO@SOLUTIONSWITHINNOVATION.COM