

Appendix

U

Fitting Materials

Material				Product Type				
Type	Condition	Standard	Grade	Seal-Lok, Triple-Lok, Ferulok, Intru-Lok, Pipe, Port Adapters, JIS, Komatsu, Flanges				
				Body	Nut	Sleeve	Ferrule	Welding Parts
Steel ¹⁾	Bar Stock	ASTM A108	12L14	•	•	•	•	
		ASTM A108	C1045	•	•	•		
		ASTM A108	C1018		•			•
	Cold Form	ASTM A576	C1008	•	•	•		
		ASTM A576	C1010	•	•	•		
		ASTM A576	C1012	•	•	•		
		ASTM A576	C1020			•		
	Forging	ASTM A576	1214	•				
		ASTM A576	1215	•				
		ASTM A576	C1045	•	•			
Stainless Steel ²⁾	Bar Stock	ASTM A479	316	•	•	•		•
		ASTM A479	316L					
		ASTM A564	630				•	
	Cold Form	ASTM A479	316	•	•	•		•
		ASTM A479	316L					
	Forging	ASTM A182	316	•	•			
ASTM A182		316L						
Brass ³⁾	Bar Stock	ASTM B16	CA360	•	•		•	
		ASTM B453	CA345	•	•			
		ASTM B371	CA694			•		
	Cold Form	ASTM B121	CA335	•	•			
		ASTM B111	CA443			•		
		ASTM B111	CA444			•		
	Forging	ASTM B124	CA377	•				
Aluminum	Bar Stock	ASTM B211	2024-T351	•	•	•		
	Forging	AMS 4133	2014-T6	•				

¹⁾ Standard steel products have silver/clear zinc chromium 6 free plating. Brazing and welding products are not plated.

²⁾ Stainless steel fittings are passivated. Standard stainless steel nuts are coated to prevent galling during assembly.

³⁾ Brass is not available for Ferulok. Where brass is required, use Intru-Lok. Intru-Lok is only available in brass.

Table U1 — Standard Material Specifications

Material					Product Type		
Type	Condition	Standard	Grade	U.S. Equivalent grade	EO, EO2, K4		
					Body	Nut	Welding Parts
Steel ¹⁾	Bar Stock	DIN EN 10277-3	1.0718	12L14	•		
		DIN EN 10277-3	1.0715	1213	•		
		DIN EN 10277-3	1.0727	1146	•		
	Cold Form	DIN EN 10277-3	1.0401	C1015			•
		DIN EN 10263	1.0214	C1010		•	
	Forging	DIN 1651	1.0710		•		
		DIN EN 10087	1.0764		•		
DIN EN 10083		1.0503	C1045 modified		•		
Stainless Steel	Bar Stock	DIN EN 10088	1.4571	316TI	•	•	•
	Forging	DIN EN 10088	1.4571	316TI	•	•	•
Brass	Bar Stock	DIN 17660	2.0540		•	•	
	Forging	DIN 17660	2.0540		•		

¹⁾ Standard steel products have silver/clear zinc chromium 6 free plating. Brazing and welding products are not plated.

Table U2 — Standard Material Specifications for EO and K4 Product

Recommended Tube Wall Thickness

Fitting Dash Size	Product Type						
	Tube O.D. (inch)	Recommended Wall Thickness (Inch)					
		Seal-Lok		Triple-Lok		Ferulok	
		Min.	Max.	Min.	Max.	Min. ¹⁾	Max. ²⁾
-2	1/8	-	-	0.010	0.035	0.010	0.035
-3	3/16	-	-	0.010	0.035	0.020	0.049
-4	1/4	0.020	0.083	0.020	0.065	0.028	0.065
-5	5/16	-	-	0.020	0.065	0.028	0.065
-6	3/8	0.020	0.109	0.020	0.065	0.035	0.095
-8	1/2	0.028	0.148	0.028	0.083	0.049	0.120
-10	5/8	0.035	0.134	0.035	0.095	0.058	0.120
-12	3/4	0.035	0.148	0.035	0.109	0.065	0.120
-14	7/8	0.035	0.156	0.035	0.109	0.072	0.120
-16	1	0.035	0.188	0.035	0.120	0.083	0.148
-20	1 1/4	0.049	0.220	0.049	0.120	0.095	0.188
-24	1 1/2	0.049	0.250	0.049	0.120	0.095	0.220
-32	2	0.058	0.250	0.058	0.134	0.095	0.220

¹⁾ Thinner tubing may be used with support of an insert.

²⁾ Thicker tubing may be used, but pressure capability is limited by fitting.

³⁾ Please consult Parker Hannifin Tube Fittings Division for tube sizes not listed.

Table U3 — Recommended Inch Tube Wall Thickness

Metric Tube							
Tube O.D. (inch)	Recommended Wall Thickness (mm)						
	Fitting Size	Seal-Lok			Triple-Lok		
		Min.	Max.	Fitting Size	Min.	Max.	
		Min.	Max.	Fitting Size	Min.	Max.	
6	-4	0.5	2.25	-4	0.5	2.0	
8	-6	1.0	2.5	-5	0.5	2.0	
10	-6	1.0	3.0	-6	0.5	2.0	
12	-8	1.0	3.5	-8	1.0	2.0	
14	-10	1.0	4.0	-10	1.0	2.5	
15	-10	1.0	3.0	-10	1.0	2.5	
16	-10	1.0	3.0	-10	1.0	2.5	
18	-12	1.0	3.0	-12	1.0	3.0	
20	-12	1.5	4.0	-12	1.0	3.0	
22	-16	1.0	3.0	-14	1.0	3.0	
25	-16	2.0	5.0	-16	1.0	3.0	
28	-20	1.5	5.0	-	-	-	
30	-20	2.0	5.0	-20	1.5	3.0	
32	-20	2.0	2.5	-20	1.5	3.0	
35	-24	2.0	6.0	-	-	-	
38	-24	2.5	7.0	-24	1.5	3.0	
50	-	-	-	-32	1.5	3.5	

Table U4 — Recommended Metric Tube Wall Thickness

Selection of Fitting Type

Tube End Connections

Threads, Conformance Specifications and Use

			SAE J514 ISO 8434-1 JIS B2351		ISO 8434-4		
Description	O-Ring Face Seal (ORFS) "Seal-Lok"	37° Flare "Triple-Lok"	Inch 24° Cone Flareless "Ferulok"	Metric 24° Cone Flareless "EO" and "EO2"	Metric 24° Cone Flareless "JIS"	30° Flare and 60° Cone "JIS"	
Thread Type	ISO 263 ANSI B1.1 unified	ISO 263 ANSI B1.1, unified	ISO 263 ANSI B1.1, unified	ISO 261 Metric fine	ISO 261 JIS B 0207	ISO 228-1 JIS B0202, BS2779	
ISO No.	8434-3 (12151-1) ¹⁾	8434-2 (12151-6) ¹⁾	—	8434-1 & -4 (12151-2) ¹⁾	—	—	
SAE No.	J1453/J516 ²⁾	J514/J516 ²⁾	J514	—	—	—	
DIN No.	—	—	—	3861, 3865 & 20078 ²⁾	—	—	
JIS No.	—	—	—	Similar to B2351	B2351	B8363 ³⁾	
BSI No.	—	—	—	—	—	Similar to BS 5200 ⁴⁾	
Current use	Mainly used in North America slowly gaining acceptance in Europe and Japan.	Used throughout the world with major usage in North America.	Mainly used in North America.	Mainly used in Europe. Slowly gaining acceptance in North America.	Mainly used in Japan for hard plumbed systems.	Mainly used in Japan, U.K. and British commonwealth countries.	

Table U5 — Tube End Connections

- 1) Hose fitting specification no.
- 2) Hose fitting specification no.
- 3) Adapter and hose fitting specification no.
- 4) 60° cone fittings only. See page U6 for more information.

Dimensions and pressures for reference only, subject to change.

Selection of Fitting Type

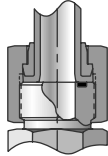
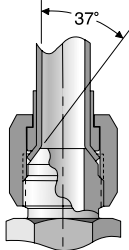
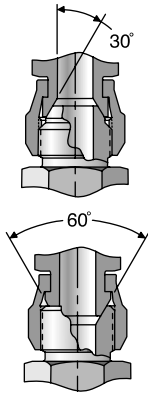
Tube End Connections

Thread Size Guide — Inch Thread

Tube O.D. or Adapter Size			O-ring Face Seal (ORFS)	37° Flare	Inch 24° cone ³⁾ Flareless	SAE 45° Flare ³⁾
Nominal metric size ³⁾	Nominal Inch		SAE J1453	SAE J514	SAE J514	SAE J512
	size	SAE dash size	“Seal-Lok”	“Triple-Lok”	“Ferulok”	
(mm)	(in)		Inch ANSI B1.1, unified (ISO 263)	Inch ANSI B1.1, unified (ISO 263)	Inch ANSI B1.1, unified (ISO 263)	Inch ANSI B1.1, unified (ISO 263)
—	1/8	-2	—	5/16-24	5/16-24	5/16-24
4	—	—	—	—	—	—
5	3/16	-3	—	3/8-24	3/8-24	3/8-24
6	1/4	-4	9/16-18	7/16-20	7/16-20	7/16-20
8	5/16	-5	—	1/2-20	1/2-20	1/2-20
10	3/8	-6	11/16-16	9/16-18	9/16-18	5/8-18
12	1/2	-8	13/16-16	3/4-16	3/4-16	3/4-16
14	5/8	-10	1-14	7/8-14	7/8-14	7/8-14
15 ¹⁾	5/8	-10	1-14	7/8-14	—	—
16	5/8	-10	1-14	7/8-14	—	—
18 ¹⁾	3/4	-12	1 3/16-12	1 1/16-12	1 1/16-12	1 1/16-14
20	3/4	-12	1 3/16-12	1 1/16-12	—	—
22 ¹⁾	7/8	-14	—	1 3/16-12	1 3/16-12	—
25	1	-16	1 7/16-12	1 5/16-12	1 5/16-12	—
28 ¹⁾	1 1/4	-20	1 11/16-12	—	1 5/8-12	—
30	1 1/4	-20	1 11/16-12	1 5/8-12	—	—
32 ²⁾	1 1/4	-20	1 11/16-12	1 5/8-12	—	—
38	1 1/2	-24	2-12	1 7/8-12	1 7/8-12	—
50	2	-32	2 1/2-12	2 1/2-12	2 1/2-12	—

Table U6 — Tube End Connections

- 1) Not preferred for high pressure applications.
- 2) Non-preferred size. Use 30mm size in place of 32mm size.
- 3) Metric tube sizes do not apply to “Ferulok” and 45° flare fittings.

Dimensions and pressures for reference only, subject to change.

Selection of Fitting Type

Tube End Connections

Thread Size Guide — Metric, BSPP and JIS Threads

Tube O.D. or Adapter Size (mm)	Metric 24° cone			Metric 24° cone Flareless	60° Cone	30° Flare and 60° Cone
	Flareless DIN 3861 LL Series Metric ISO 261	Weld Nipple DIN 3865 L Series Metric ISO 261	“EO” and “EO-2” S Series Metric ISO 261	JIS B2351 “JIS” Metric ISO 261 (JIS B0207)	BS 5200 ISO 228-1 (BSPP) ⁵⁾	JIS B8363 ISO 228-1 (JIS B 0202) (BSPP) ⁵⁾
—	—	—	—	—	—	—
4	M8 x 1	—	—	—	—	—
5	M10 x 1 ³⁾	—	—	—	—	—
6	M10 x 1	M12 x 1.5	M14 x 1.5	M12 x 1.5	G 1/8 A	G 1/4 B
8	M12 x 1	M14 x 1.5	M16 x 1.5	M14 x 1.5	G 1/4 A	—
9 ²⁾	—	—	—	—	—	G 3/8 B
10	M14 X 1 ⁴⁾	M16 x 1.5	M18 x 1.5	M16 x 1.5	G 3/8 A	—
12	M16 x 1 ⁴⁾	M18 x 1.5	M20 x 1.5	M18 x 1.5	G 1/2 A	G 1/2 B
14	—	—	M22 x 1.5	—	—	—
15 ¹⁾	—	M22 x 1.5	—	—	—	—
16	—	—	M24 x 1.5	M24 x 1.5	G 5/8 A ⁶⁾	—
18 ¹⁾	—	M26 x 1.5	—	—	—	—
19 ²⁾	—	—	—	—	—	G 3/4 B
20	—	—	M30 x 2	M28 x 1.5	G 3/4 A	—
22 ¹⁾	—	M30 x 2	—	—	—	—
25	—	—	M36 x 2	M35 x 1.5	G 1 A	G 1 B
28 ¹⁾	—	M36 x 2	—	—	—	—
30	—	—	M42 x 2	M40 x 1.5	G 1-1/4 A	—
32 ²⁾	—	—	—	—	—	G 1-1/4 B
35 ¹⁾	—	M42 x 2	—	—	—	—
38	—	—	M52 x 2	M48 x 1.5	G 1-1/2 A	G 1-1/2 B
42 ¹⁾	—	M52 x 2	—	—	—	—
50	—	—	—	—	G 2 A	G 2 B

Table U7— Tube End Connections

- 1) Not preferred for high pressure applications.
- 2) Not preferred sizes. Use 10mm, 20mm and 30mm sizes in place of 9mm, 19mm and 32mm sizes, respectively.
- 3) Covered in ISO 8434-1. Non-standard with Parker TFDE (Ermeto).
- 4) Not part of DIN or ISO standards, but offered by Parker TFDE (Ermeto).
- 5) ISO 228-1 G threads and JIS B 0202 G or PF threads can be interchanged. “A” and “B” indicate different tolerance classes on the male threads, “A” having tighter tolerances than “B”.
- 6) Non-preferred size.

Dimensions and pressures for reference only, subject to change.

Selection of Fitting Type

Port End Connections

Threads, Conformance Specifications, and Use

				
Port Description	Metric Straight Thread O-Ring Port	SAE Straight Thread O-Ring Port	Four Screw Split Flange	Four Screw One Piece Square Flange
Thread Type	ISO 261 Metric Fine	ISO 263 ANSI B1.1, Unified	Metric screws: ISO 261 Inch screws: ISO 263	ISO 261
ISO No.	6149	11926	6162	6164
SAE No.	J2244	J1926	J518 (covers inch screws only)	—
DIN No.	3852-3 Form "W"	—	—	—
JIS No.	—	—	B8363 (covers flange head only)	—
BSI No.	—	—	—	—
Current use	Gaining use in U.S. and western Europe. Widely used in former Soviet block countries.	Widely used in North America. Limited use in the rest of the world.	Widely used throughout the world.	Mainly used in Germany. Limited use elsewhere.

Table U8 — Port End Connections

Dimensions and pressures for reference only, subject to change.

Selection of Fitting Type

Port End Connections Threads, Conformance Specifications, and Use

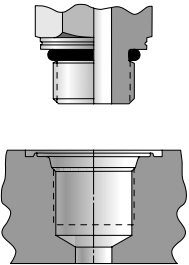
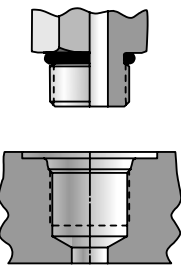
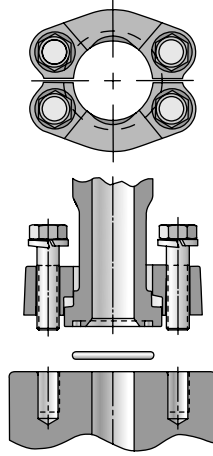
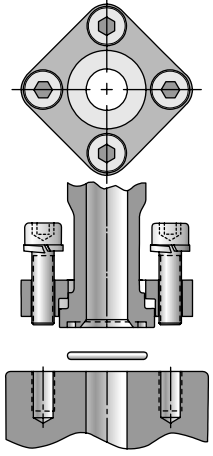
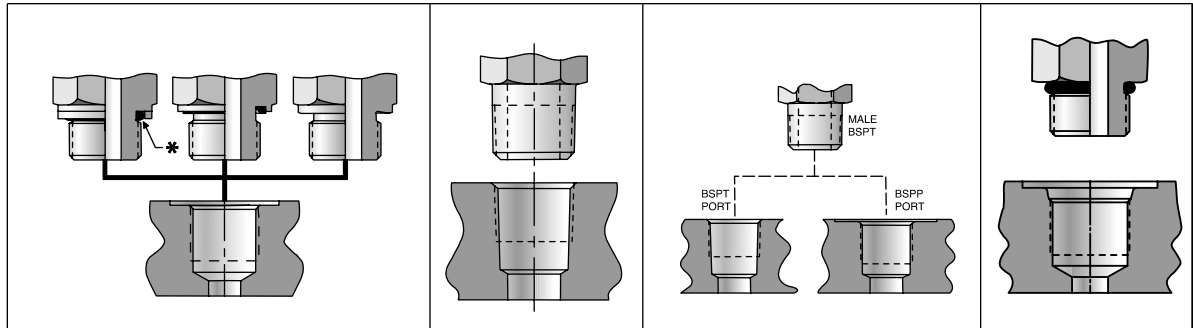

Port Description	British Standard Pipe Parallel (BSPP) Flat Face Port	Metric Straight Thread Flat Face Port	NPTF - Dryseal American Standard Taper Pipe	JIS/BSPT British Standard Pipe, Taper	JIS/BSPP British Standard Pipe, Parallel O-ring Port
Thread Type	ISO 228-1 BS 2779	ISO 261 Metric Fine	ANSI B1.20.3	ISO 7 BS 21 JIS B 0203	ISO 228-1 BS 2779 JIS B 0202
ISO No.	1179	9974	—	—	—
SAE No.	—	—	J476	—	—
DIN No.	3852-2 Form X or Y	3852-1 Form X or Y	—	Similar to: 3852-2 form Z	—
JIS No.	—	—	—	B8363	B2351 Type "O"
BSI No.	—	—	—	—	Similar to BS 5380
Current use	Most popular in western Europe and former UK colonies. Limited use in rest of the world.	Moderate use in Europe, mainly in Germany.	Mainly used in North America some use in rest of the world.	Mainly used in Japan and parts of western Europe.	Mainly used in Japan. Some use in U.K. of similar port, BS5380.

Table U9 — Port End Connections

Dimensions and pressures for reference only, subject to change.

Pre-Setting Tools

Hydra-Tool Pre-Setting Pressures for EO and EO-2 Steel Fittings

Pressures for Steel EO Fittings Using Stop Adapter (971107 & 971108)

Pre-Setting Pressures (psi) for EO Fittings Wall Thickness (mm)							
Size	Series	1.0	1.5	2.0	2.5	3.0	4.0
6	L	500	500	500			
6	S	500					
8	L	500		500			
8	S	500	500				
10	L		500				
10	S		500				
12	L	300	300	500			
12	S		300				
14	S			1,500			
15	L		500	800			
16	S			1,200		1,300	
18	L		1,000			1,300	
20	S				2,000		
22	L		1,500	1,500			
25	S					2,000	2,000
28	L			2,000			
30	S					3,000	
35	L			3,000		3,300	
38	S						3,500
42	L					4,000	

Table U10 — Pre-Setting Pressures for Steel EO Fittings

NOTE: The values provided in this chart are provided as a guide only and normally will produce a satisfactory bite when using the Parker Hydra-Tool.

Pressures for Steel EO-2 Fittings Using Stop Adapter (971107 & 971108)

Hydra-Tool Pre-Setting Pressures (psi) for EO-2 Fittings in Steel and Stainless Steel Using the Stop Adapter		
Size	Series	psi
6	L	1,100
6	S	1,100
8	L	1,300
8	S	1,300
10	L	1,800
10	S	1,800
12	L	2,000
12	S	2,000
14	S	2,300
15	L	2,300
16	S	3,000
18	L	3,000
20	S	4,100
22	L	3,100
25	S	5,500
28	L	3,700
30	S	6,600
35	L	5,300
38	S	8,400
42	L	7,600

Table U11 — Pre-Setting Pressures for Steel and Stainless Steel EO-2 Fittings

NOTE: The values provided in this chart are provided as a guide only and normally will produce a satisfactory bite when using the Parker Hydra-Tool.

Hydra-Tool Pre-Setting Pressures for Ferulok Fittings^{1) 2) 3)}

Tube Size	Wall Thickness – Steel							Wall Thickness – Stainless Steel						
	0.035	0.049	0.065	0.083	0.095	0.109	0.120	0.035	0.049	0.065	0.083	0.095	0.109	0.120
4	300	300	500	600	600	600		300	300	500	700	700	700	
6	300	500	600	700	700	700	700	300	500	700	700	700	700	800
8		500	700	800	900	1,000	1,000		600	700	1,000	1,000	1,100	1,100
10			700	900	1,000	1,100	1,100			800	1,000	1,100	1,300	1,300
12			900	1,000	1,100	1,100	1,300			1,000	1,100	1,300	1,300	1,500
14			1,000	1,100	1,100	1,300	1,500			1,000	1,300	1,300	1,500	1,600
16				1,100	1,300	1,500	1,600				1,500	1,500	1,600	1,600
20					1,500	1,600	1,800					1,600	2,000	2,000
24					1,800	2,000	2,300					2,100	2,300	2,300
32					2,800	2,900	3,300					3,100	3,300	3,300

Table U12 — Hydra-Tool Recommended Pre-Setting Pressures for Inch Tube

- 1) These values are provided as a guide only and normally will produce a satisfactory bite.
- 2) Ferulok pre-setting dies are positive stop dies. Use of above pressures is optional.
- 3) For wall thicknesses greater than those listed, contact the Tube Fittings Division.

Dimensions and pressures for reference only, subject to change.



Hyferset Pre-Setting Pressures for Ferulok Fittings¹⁾

Tube Size	Wall Thickness – Steel							Wall Thickness – Stainless Steel						
	0.035	0.049	0.065	0.083	0.095	0.109	0.120	0.035	0.049	0.065	0.083	0.095	0.109	0.120
4	800	900	1,400	1,800	1,800	1,800		900	1,000	1,500	2,000	2,000	2,000	
6	900	1,400	800	2,000	2,000	2,000	2,200	1,000	1,500	2,000	2,000	2,000	2,000	2,500
8		1,600	2,000	2,500	2,700	3,000	3,200		1,800	2,200	3,000	3,000	3,500	3,500
10			2,200	2,700	3,000	3,500	3,500			2,500	3,000	3,500	4,000	4,000
12			2,700	3,000	3,500	3,500	4,000			3,000	3,500	4,000	4,000	4,500
14			3,000	3,500	3,500	4,000	4,500			3,000	4,000	4,000	4,500	5,000
16				3,500	4,000	4,500	5,000				4,500	4,500	5,000	5,000
18				4,000	4,500	4,500	5,000				4,500	5,000	5,000	5,500
20					4,500	5,000	5,500					5,000	6,000	6,000
24					5,500	6,000	7,000					6,500	7,000	7,000
28					7,000	7,500	8,000					7,500	8,000	8,500
32					8,500	9,000	10,000					9,500	10,000	10,000

Table U13 – Pre-Setting Pressures for Ferulok Fittings

1) Ferulok pre-setting dies are positive stop dies. Use of above pressures is optional.

Hyferset Pre-Setting Pressures for EO Steel Fittings²⁾

Pre-Setting Pressures (psi) for EO Fittings					
Tube Size (mm)	Wall Thickness (mm)				
	1.0	1.5	2.0	2.5	3.0
6-L	650	650			
6-S	650	650			
8-L	900	900			
8-S	900	900			
10-L	1,350	1,350	1,550		
10-S	1,350	1,350	1,550		
12-L	1,750	1,750	1,750	1,750	
12-S	1,750	1,750	1,750	1,750	
14-S		2,000	2,000	2,200	2,200
15-L	1,800	1,800			
16-S		2,200	1,450	1,450	
18-L	2,000	2,000	2,000		
20-S			3,300	3,500	
22-L		3,100	3,100		
25-S				4,000	4,000
28-L		3,500	3,500		

Table U14 – Pre-Setting Pressures for EO Fittings

2) EO and EO-2 pre-setting dies are not positive stop style. Pre-setting must be done using pressures given in these charts.

Hyferset Pre-Setting Pressures for EO-2 Steel Fittings²⁾

Hyferset Pre-Setting Pressures (psi) for EO-2 Fittings		
Size	Series	Any wall
6	L	1,150
6	S	1,150
8	L	1,450
8	S	1,450
10	L	2,450
10	S	2,450
12	L	2,800
12	S	2,800
14	S	3,500
15	L	2,800
16	S	3,900
18	L	3,200
20	S	5,600
22	L	4,950
25	S	6,400
28	L	5,600

Table U15 – Pre-Setting Pressures for EO-2 Fittings

2) EO and EO-2 pre-setting dies are not positive stop style. Pre-setting must be done using pressures given in these charts.

Dimensions and pressures for reference only, subject to change.

Hydra-Tool

Recommended Flaring Pressures For Metric Tube

Size (mm)	Material	Tube Wall Thickness					Min. Straight Length to Start of Bend
		1.0	1.5	2.0	2.5	3.0	
6	SS	400	700	1100			1-5/8
	Steel	300	500	800			
	Copper	150	200	350			
	Aluminum	150	200	350			
8	SS	500	800	1300			1-5/8
	Steel	400	600	1000			
	Copper	150	250	400			
	Aluminum	150	250	400			
10	SS	600	900	1500			1-5/8
	Steel	500	700	1100			
	Copper	200	300	500			
	Aluminum	200	300	500			
12	SS	800	1200	2000	2500		2-3/16
	Steel	600	900	1500	1900		
	Copper	250	350	600	750		
	Aluminum	250	350	600	750		
16	SS	900	2000	2500	2800	3000	2-5/16
	Steel	680	1500	1900	2100	2300	
	Copper	275	600	750	800	900	
	Aluminum	275	600	750	800	900	
18	SS	1000	1700	2500	3100	3500	2-5/16
	Steel	750	1300	1900	2300	2700	
	Copper	300	500	750	900	1100	
	Aluminum	300	500	750	900	1100	
20	SS		1500	2400	3000	3400	2-7/16
	Steel		1100	1800	2300	2600	
	Copper		500	700	900	1000	
	Aluminum		500	700	900	1000	
25	SS			2400	3000	3400	2-7/16
	Steel			1800	2300	2600	
	Copper			700	900	1000	
	Aluminum			700	900	1000	
30	SS			2800	3400	4000	2-1/2
	Steel			2100	2600	3000	
	Copper			800	1000	1200	
	Aluminum			800	1000	1200	
32	SS				4000	4500	2-7/8
	Steel				3000	3400	
	Copper				1200	1300	
	Aluminum				1200	1300	
38	SS				4500	5800	2-7/8
	Steel				3400	4400	
	Copper				1300	1700	
	Aluminum				1300	1700	
42	SS				4700	6500	2-7/8
	Steel				3600	5200	
	Copper				1500	1900	
	Aluminum				1500	1900	
50	SS				5200	7200	2-7/8
	Steel				3900	6100	
	Copper				1900	2300	
	Aluminum				1900	2300	

Table U16 — Recommended Flaring Pressures, Metric Tube

Dimensions and pressures for reference only, subject to change.



Hydra-Tool

Recommended Flaring Pressures For Inch Tube

Size	Material	Tube Wall Thickness								Minimum Straight Length To Start of Bend
		0.035	0.049	0.065	0.083	0.095	0.109	0.120	0.134	
4	SS	400	700	1100						1-5/8
	Steel	300	500	800						
	Copper	150	200	350						
	Aluminum	150	200	350						
5	SS	500	800	1300						1-5/8
	Steel	400	600	1000						
	Copper	150	250	400						
	Aluminum	150	250	400						
6	SS	600	900	1500						1-5/8
	Steel	500	700	1100						
	Copper	200	300	500						
	Aluminum	200	300	500						
8	SS	800	1200	2000	2500					2-3/16
	Steel	600	900	1500	1900					
	Copper	250	350	600	750					
	Aluminum	250	350	600	750					
10	SS	900	2000	2500	2800	3000				2-5/16
	Steel	680	1500	1900	2100	2300				
	Copper	275	600	750	800	900				
	Aluminum	275	600	750	800	900				
12	SS	1000	1700	2500	3100	3500	4000			2-5/16
	Steel	750	1300	1900	2300	2700	3000			
	Copper	300	500	750	900	1100	1200			
	Aluminum	300	500	750	900	1100	1200			
14	SS		1500	2400	3000	3400	4200			2-7/16
	Steel		1100	1800	2300	2600	3200			
	Copper		500	700	900	1000	1300			
	Aluminum		500	700	900	1000	1300			
16	SS			2400	3000	3400	4200	4800		2-7/16
	Steel			1800	2300	2600	3200	3600		
	Copper			700	900	1000	1300	1400		
	Aluminum			700	900	1000	1300	1400		
20	SS			2800	3400	4000	4800	5300		2-1/2
	Steel			2100	2600	3000	3600	4000		
	Copper			800	1000	1200	1400	1600		
	Aluminum			800	1000	1200	1400	1600		
24	SS				4000	4500	5300	5800		2-7/8
	Steel				3000	3400	4000	4400		
	Copper				1200	1300	1600	1700		
	Aluminum				1200	1300	1600	1700		
32	SS					3300	4000	5000	6300	3
	Steel					2500	3000	3800	4700	
	Copper					1000	1200	1500	1900	
	Aluminum					1000	1200	1500	1900	

Table U17 — Recommended Flaring Pressures, Inch Tube

Note: If tube size and wall thickness are not shown on this chart, see page U3, Table U3 for recommended tube size for use with 37° flare fittings.

Dimensions and pressures for reference only, subject to change.



Counterbores and Taps

Recommended Use of Porting Tools

Parker offers porting tools for machining precision ports (glands) conforming to DIN 3852-1, SAE J1926-1 (SAE straight thread port) and the new world standard port, ISO 6149-1.

Machining ports to accept Parker tube fittings is completed in three simple steps.

To begin, select the appropriate size port tooling for the fitting end in question. Next, follow these machining steps.

1. Pilot Hole Drilling.

First, make a pilot hole for the counterbore by using a drill or bore size found in the counterbore tooling tables. Make hole depth according to the port detail on pages T32, T33 and T36. Parker Tube Fittings Division does not sell tap drills or bore tooling.

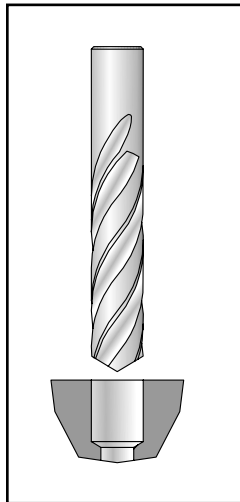

Fig. U1 — Pilot drilling for counterbore tool

2. Port Counterboring.

Then, run the counterbore tool into the pilot diameter created in step 1. All features and dimensions of the port and O-ring cavity are built into the counterboring tool except the depth. The depth of the counterbore machining may vary from a light spotface, up to the maximum spotface depth listed on the port detail on pages U7 and U8.

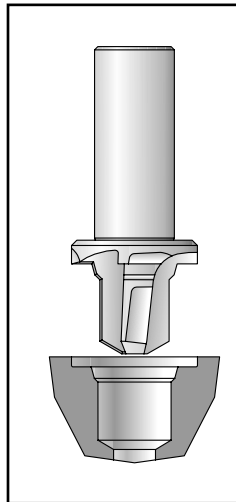

Fig. U2 — Counterboring tool

3. Thread Tapping.

Lastly, the machined port must be threaded to accommodate the fitting. Use the appropriate Parker tapping tool or another tap intended for the same thread type, size, and class.

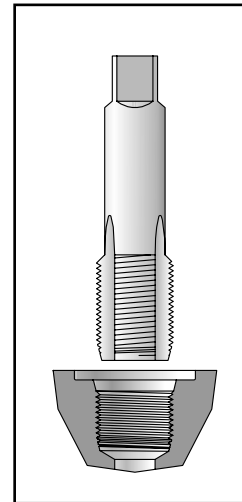

Fig. U3 — Tapping

Note: It is necessary to create a spotface surface which is flat and perpendicular to the port, and with a smooth finish to prevent leakage or O-ring extrusion. Cast or forged surfaces must be spotface machined to meet these requirements. Even on smooth surfaces (machined surfaces), it is necessary to lightly touch the surface to assure a smooth radius at the entrance of the port.

Reference Material

Applicable Standards For TFD Products by Standard Number

ASTM A269	Seamless and welded type 316 Stainless Steel tubing	NFPA T3.8.3 ²⁾	Test methods for steel separable tube fittings
ASTM B633	Zinc plating	SAE J343	Tests and procedures for hose and hose assemblies (impulse test applies to fittings)
ASTM F1387	Mechanically attached fittings – Triple-Lok, Ferulok and Seal-Lok	SAE J356	Welded and flash controlled low carbon steel tubing
DIN 2353	24° cone compression (bite-type) fitting range (configurations)	SAE J512	Automotive tube fittings - 45° flare type - Inverted flare type - Tapered sleeve compression type
DIN 3852-1	Metric parallel thread port (ISO 9974-1)	SAE J514	Hydraulic tube fittings - 37° flare (Triple-Lok) - Flareless – 24° bite type (Ferulok) - O-ring plugs - Pipe fittings - Adapter unions (pipe swivel – “07” adapters)
DIN 3852-2	BSPP parallel thread port (ISO 1179-1)	SAE J515	Hydraulic O-rings (SAE straight thread, face seal, four-bolt split flange, and metric O-ring port)
DIN 3852-3	Metric O-ring port (ISO 6149-1)	SAE J518	Code 61 and 62 four-bolt split flange connections – (same as ISO 6162 Type II flange connection)
DIN 3861	24° cone machining and sleeve for compression (bite-type) fittings	SAE J524	Seamless low carbon steel tubing
DIN 3865	24° cone nipple with O-ring	SAE J525	Welded and cold drawn low carbon steel tubing
DIN 3859	Technical delivery conditions for compression fittings	SAE J527	Brazed double wall steel tubing
DIN 1630	Seamless steel tube	SAE J528	Seamless copper tube
DIN 2391	Seamless precision steel tubes	SAE J531	Automotive pipe, filler and drain plugs (HP and HHP plugs)
DIN 17458	Stainless steel tubes	SAE J533	Flares for tubing – 37° and 45° single and double flares
ISO 1179	BSPP, flat face port and stud ends – same as DIN 3852 - Part 2	SAE J846	Coding system for identification of fluid connectors
ISO 3304	Seamless precision steel tubes	SAE J1065	Pressure ratings for hydraulic tubing
ISO 3305	Welded precision steel tubes	SAE J1231	Beaded tube hose fittings
ISO 6149	Metric straight thread O-ring port and stud ends – same as SAE J2244 and DIN 3852, Part 3	SAE J1453	O-ring face seal fitting with SAE port end – (Seal-Lok)
ISO 6162	Four bolt split flange connections – inch and metric bolts (inch bolt, Part II – same as SAE J518)	SAE J1644	Test methods for fluid connectors
ISO 8434-1	24° cone bite type fittings (EO fittings)	SAE J1926	SAE straight thread O-ring port and stud ends – same as ISO 11926
ISO 8434-2	Metric 37° flare fittings (Metric Triple-Lok)	SAE J2244	Metric straight thread O-ring port and stud ends – same as ISO 6149
ISO 8434-3	Metric face seal fitting with ISO 6149 port end – (Metric Seal-Lok)	SAE J2435	Welded and flash controlled C-1021 tubing
ISO 8434-4	24° cone bite type fittings with weld nipple (EO Fittings)	SAE J2467	Welded and cold drawn, C-1021 tubing
ISO 19879	Test methods for threaded fluid connectors	SAE J2613	Welded and flash controlled high strength low alloy (HSLA) tubing
SIO 8434-6	60° cone connectors with BSPP threads	SAE J2614	Welded and cold drawn HSLA tubing
ISO 9974	Metric flat face port and stud ends – same as DIN 3852 - Part 1		
JIS B8363	60° cone (male and female) hose adapters		
MIL-16142	UN/UNF straight thread O-ring port – same as SAE J1926-1		
MIL-F-18866	37° flare and flareless tube fittings – Triple-Lok and Ferulok (dimensionally similar to SAE J514)		
MIL-33649	Straight thread O-ring port – different from SAE J1926-1		

Table U18 — Applicable Standards by Standard Number

Reference Material

Thread Designations and Standards for Threads Used in Fluid Connectors

Abbreviation	Description	Applicable Std.
Straight Pipe		
NPSC	American Standard Straight Pipe Threads in Pipe Couplings Couplings	ANSI B1.20.1 FED-STD-H28/7
NPSF	Dryseal American Standard Fuel Internal Straight Pipe Threads (generally used in soft or ductile materials to mate with NPTF external taper threads)	SAE J476 ANSI B1.20.3 FED-STD-H28/8
NPSI	Dryseal American Intermediate Internal Straight Pipe Threads (for brittle or hard materials; intended to mate with PTF-SAE short external taper threads)	SAE J476 ANSI B1.20.3 FED-STD-H28/8
NPSM	American Standard Straight Pipe Threads for Free-Fitting Mechanical Joints for Fixtures (these threads fit freely over NPTF threads. They are used in swivel nuts of 07 adapters)	ANSI B1.20.1 FED-STD-H28/7
Taper Pipe		
ANPT	Aeronautical National Taper Pipe Threads (similar to NPT with various additional requirements in gaging)	MIL-P-7105
NPT	American Standard Taper Pipe Threads for General Use	ANSI B1.20.1 FED-STD-H28/7
NPTF	Dryseal American Standard Taper Pipe Threads (used in all of our steel and brass fittings)	SAE J476 ANSI B1.20.3 FED-STD-H28/8
PTF — SAE Short	Dryseal SAE Short Taper Pipe Threads (mainly used in low pressure pneumatic and fuel applications)	SAE J476 ANSI B1.20.3 FED-STD-H28/8
PTF — SPL Short ¹⁾	Dryseal Special Short Taper Pipe Threads	ANSI B1.20.3
PTF — SPL Extra Short ¹⁾	Dryseal Special Extra Short Taper Pipe Threads	ANSI B1.20.3
Unified Threads		
UN	Unified Constant Pitch Threads (standard series: 4, 6, 8, 12, 16, 20, 28, 32)	ANSI B1.1 FED-STD-H28/2
UNC	Unified Coarse Threads	ANSI B1.1 FED-STD-H28/2
UNEF	Unified Extra Fine Threads	ANSI B1.1 FED-STD-H28/2
UNF	Unified Fine Threads	ANSI B1.1 FED-STD-H28/2
UNS	Unified Special Pitch Threads	ANSI B1.1 FED-STD-H28/3
UNJ	Unified Controlled Root Radius Threads	ANSI B1.15 FED-STD-H28/4

Table U19 — Thread Designations and Standards for Threads Used in Fluid Connectors (continued on the next page)

1) Used in some pneumatic components where shortened thread depth is required because of lack of enough material due to component size limitations.

Reference Material

Thread Designations and Standards for Threads Used in Fluid Connectors (Continued)

Abbreviation	Description	Applicable Std.
Metric Threads		
M	Metric Screw Threads — M profile	ISO 261 ANSI B1.13M FED-STD-H28/21
M — Keg	Metric Taper Threads (mainly used in Germany)	DIN 158
British Standard Pipe Threads		
R (BSPT)	British Standard Taper Pipe Threads, External	BS 21 ISO 7/1
Rc (BSPT)	British Standard Taper Pipe Threads, Internal	BS 21 ISO 7/1
Rp or G (BSPP)	British Standard Pipe (Parallel) Threads	BS 2779 ISO 228/1
Japanese Standard Pipe Threads		
PF ¹⁾	JIS Parallel Pipe Threads	JIS B202 ISO 228/1
PT ¹⁾	JIS Taper Pipe Threads	JIS B203 ISO 7/1
PS	JIS Parallel Internal Pipe Threads (to mate with PT threads)	JIS B203

Table U19 (Cont'd) — Thread Designations and Standards for Threads Used in Fluid Connectors

1) PF and PT threads are functionally interchangeable with BSPP and BSPT threads, respectively. These are old designations. They are being replaced with G (for PF) and R and Rc (for PT) as documents are revised.

Document Sources for Connector Specifications

ANSI American National Standards Institute
11 West 42nd Street, 13th Floor
New York, New York 10036-8002
Phone: 212-642-4900
Fax: 212-398-0023
www.ansi.org/public/std_info.html

FED-STD Federal Standard
Department of Defense Single Stock Point
Commanding Officer
Naval Publications and Forms Center
5801 Taber Avenue
Philadelphia, PA 19120-5099

BSI British Standards Institution
389 Chiswick High Road
London, W4 4AL
United Kingdom
Phone: 44-181-996-9000
Fax: 44-181-996-7400
www.bsi.org.uk/bsis/index.htm

ISO International Organization for Standardization
Case Postale 56
1, Rue de Varembe
CH - 1211 Geneve 20
Switzerland
www.iso.ch/infoe/catinfo.html

ISO Documents are also available from ANSI

British Standards are also available from ANSI

DIN Deutsches Institut Fur Normung
(German Institute for Standards)
Burggrafenstrasse 6
Postfach 1107
D - 1000 Berlin 30, Germany
www.beuth.de/beuth.htm/?datenbanken

JIS Japanese Industrial Standards
Published by Japanese Standards Association
1-24 Akasaka 4
Minto-ku, Tokyo 107-8440
Japan
Phone: 81-3-3583-8000
Fax: 81-3-3586-2014

English translations of some Japanese Standards can be obtained from ANSI

English translations of some German Standards can be obtained from:

ANSI
— or —

Global Engineering Documents
15 Inverness Way East
Englewood, CO 80112-9660
Phone: 1-800-854-7179

SAE SAE International
400 Commonwealth Drive
Warrendale, PA 15096-0001
Phone: 412-776-4841
Fax: 412-776-0002
www.sae.org/prodserv/stds/stdsinfo/standard.html

Metric Conversions

SI Prefixes		
Prefix	SI Symbol	Multiplication Factor
tera	T	10^{12}
giga	G	10^9
mega	M	10^6
kilo	k	10^3
hecto	h	10^2
deka	da	10^1
deci	d	10^{-1}
centi	c	10^{-2}
milli	m	10^{-3}
micro	μ	10^{-6}
nano	n	10^{-9}
pico	p	10^{-12}
femto	f	10^{-15}
atto	a	10^{-18}

Table U20 — SI Prefixes

Derived Units			
Quantity	Unit	SI Symbol	Formula
Acceleration	Meter per Second Squared	—	m/s^2
Angular Velocity	Radian per Second	—	rad/s
Area	Square Meter	—	m^2
Density	Kilogram per Cubic Meter	—	kg/m^3
Electric Resistance	Ohm	W	V/A
Energy & Work	Joule	J	N.m
Force	Newton	N	$kg.m/s^2$
Frequency	Hertz	Hz	cycles/s
Power	Watt	W	J/s
Pressure & Stress	Pascal	Pa	N/m^2
Quantity of Heat	Joule	J	N.m
Specific Heat	Joule per Kilogram-Kelvin	—	J/kg.K
Thermal Conductivity	Watt per Meter-Kelvin	—	W/m.K
Velocity	Meter per second	—	m/s
Viscosity, Dynamic	Pascal Second	—	Pa.s
Viscosity, Kinematic	Square Meter per Second	—	m^2/s
Voltage	Volt	V	W/A
Volume	Cubic Meter	—	m^3

Table U21 — Derived Units

Basic Units		
Quantity	Unit	SI Symbol
Length	Meter	m
Mass	Kilogram	kg
Time	Second	s
Electric Current	Ampere	A
Thermodynamic Temperature	Kelvin	K
Amount of Substance	Mole	mol
Luminous Intensity	Candela	cd

Table U22 — Basic Units

Supplementary Units		
Quantity	Unit	SI Symbol
Plane Angle	Radian	rad
Solid Angle	Steradian	sr

Table U23 — Supplementary Units

Dimensions and pressures for reference only, subject to change.



Table U23 – English to Metric and Metric to English Conversions

Dimensions and pressures for reference only, subject to change.

	English to Metric			Metric to English		
	To Convert From	To	Multiply By	To Convert From	To	Multiply By
Area	sq. in. (in ²)	sq. mm (mm ²)	645.16	square millimeters (mm ²)	square inches (in ²)	0.00155
	sq. in. (in ²)	sq. cm (cm ²)	6.4516			
	sq. ft. (ft ²)	sq. meters (m ²)	0.0929			
Density	pounds/cubic ft (lb/ft ³)	Kilograms/cubic meter (kg/m ³)	16.02	kilograms/cubic meter (kg/m ³)	pounds/cubic ft (lb/ft ³)	0.0624
Energy	British thermal units (Btu) (1 J = Ws = 0.2388 cal)	joules (J)	1055	joules (J)	British thermal units (Btu)	0.000947
Force	pounds - force (lbf) (1N = 0.102 kgf)	newtons (N)	4.448	newtons (N)	pounds - force (lbf)	0.2248
Length	inches (in)	millimeters (mm)	25.4	millimeters (mm)	inches (in)	0.03937
	feet (ft)	meters (m)	0.3048	meters (m)	feet (ft)	3.281
	miles (mi)	kilometers (km)	1.609	kilometers (km)	miles (mi)	0.621
Mass (Weight)	ounces (oz)	grams (g)	28.35	grams (g)	ounces (oz)	0.035
	pounds-mass (lb)	kilograms (kg)	0.4536	kilograms (kg)	pounds-mass (lb)	2.205
	short tons (2000 lb) (tn)	metric tons (1000 kg) (t)	0.9072	metric tons (1000 kg) (t)	short tons (2000 lb) (tn)	1.102
Power	horsepower (550 ft. lb/s) (hp)	kilowatts (kW)	0.7457	kolowatts (kW)	horsepower (550 ft. lb/s) (hp)	1.341
Pressure	pounds/square inch (psi)	kilograms (f)/square cm (kg (f)/cm ²)	0.0703	kilograms (f)/square cm (kg (f)/cm ²)	pounds/square inch (psi)	14.22
	pounds/square inch (psi)	kilopascals (kPa)	6.8948	kolopascals (kPa)	pounds/square inch (psi)	0.145
	pounds/square inch (psi)	bars (100 kPa)	0.06895	bars (100 kPa)	pounds/square inch (psi)	14.503
Stress	pounds/square inch (psi) (1 N/mm ² = 1 MPa)	megapascals (MPa)	0.006895	megapascals (MPa) (1 N/mm ² = 1 MPa)	pounds/square inch (psi)	145.039
Temperature	degrees fahrenheit (°F)	degrees celsius (°C)	5/9 (after subtracting 32)	degrees celsius (°C)	degrees fahrenheit (°F)	9/5 (then add 32)
Torque or Bending Moment	pounds-force-foot (lb-ft)	Newtons-meter (Nm)	1.3567	Newtons-meter (Nm)	pounds-force-foot (lb-ft)	0.737
	pounds-force-inch (lb-in)	Newtons-meter (Nm)	0.113	Newtons-meter (Nm)	pounds-force-inch (lb-in)	8.85
Velocity	feet/second (ft/s)	meters/second (m/s)	0.3048	meters/second (m/s)	feet/second (ft/s)	3.2808
Viscosity	dynamic (centipoise)	pascal-second (Pas)	0.001	pascal-second (Pas)	dynamic (centipoise)	1000
	kenematic-foot ² /sec (ft ² /s)	meter ² /sec (m ² /s)	0.0929	meter ² /sec (m ² /s)	foot ² /sec (ft ² /s)	10.7643
Volume	cubic inch (in ³)	cubic centimeter (cm ³) (milliliter)	16.3871	cubic centimeter (cm ³) (milliliter)	cubic inch (in ³)	0.061
	quarts (qt)	liters (1000 cm ³)	0.9464	liters (1000 cm ³)	quarts (qt)	1.057
	gallons (gal)	liters	3.7854	liters	gallons (gal)	0.2642

U18

Parker Hannifin Corporation
Tube Fittings Division
Columbus, Ohio
http://www.parker.com/tfd

Glossary

Glossary of Key Tube Fittings, Fluid Power and Other Engineering Terms

Alloy: A substance having metallic properties and composed of two or more chemical elements of which at least one is a metal.

Annealing: Heat treating process used primarily to soften metals or to stabilize their structures.

Boss: A relatively short protrusion or projection from the surface of a forging or casting, often cylindrical in shape.

Brass: An alloy consisting mainly of copper (over 50%) and zinc, to which smaller amounts of other elements may be added.

Braze 505: Braze 505 is a trademark of the Handy & Harman Company.

Brazing: The joining of metals through the use of heat and capillary flow of a filler metal. The filler metal having a melting temperature above 840 degrees Fahrenheit, but below the melting point of the metals being joined.

Bright Annealing: Annealing in a protective atmosphere to prevent discoloration of the bright surface.

Brinell Hardness Test: A test for determining the hardness of a material by forcing a hard steel or carbide ball of specified diameter into it under a specified load.

Brittle Fracture: A fracture which is accompanied by little or no plastic deformation.

Brittleness: The quality of a material that leads to crack propagation without appreciable plastic deformation.

Bulk Modulus: The measure of resistance to compressibility of a fluid. It is the reciprocal of the compressibility.

Burnishing: Smoothing surfaces of a work piece through frictional contact between it and some hardened tooling.

Carbonitriding: A case hardening process of suitable ferrous material that is effected by the simultaneous absorption of nitrogen and carbon into the surface of the work piece, by heating above the lower transformation temperature in a suitable gaseous atmosphere.

Cavitation: A localized gaseous condition within a liquid stream which occurs when the pressure is reduced to the vapor pressure. Generally occurs in pumps and suction lines where fluid velocity is too high due to poorly sized (too small) line size.

Chatter: The undesirable wavy surface on a machined surface, produced by vibration of the tool, grinding wheel or work piece itself during machining or grinding.

Chromate Treatment: A treatment of metal in a solution of a hexavalent chromium compound to produce a conversion coating of chromium compounds on the surface of the metal, thus improving the resistance to corrosion.

Cold Heading: Working metal at room temperature in such a manner that the cross-sectional area of a portion or all of the stock is increased.

Cold Working (Cold Forming): Permanently deforming metal, usually at room temperature, by the application of an external force in order to produce a near net shape component.

Compressibility: The change in volume of a unit volume of a fluid when subjected to a unit change in pressure.

Corrosion: The deterioration of a metal by chemical or electrochemical reaction with its environment.

Creep: Time dependent strain occurring under stress. This phenomenon may result in relaxation i.e. the relief of pre-load/pre-stress in assembled components.

Crimping: A swaging and squeezing operation usually used to secure components, such as, nuts and shells to their mating parts.

Deburring: Removing burrs, sharp edges or fins from metal parts usually by filing, grinding or tumbling the work in a barrel containing suitable liquid medium and abrasives.

Density: Ratio of the mass of an object (including fluids) to its volume.

Diamond Pyramid Hardness Test (DPH): An indentation hardness test employing a 136° diamond pyramid indenter and variable loads.

Ductility: The ability of a metal to deform plastically (permanently) without fracturing.

Dynamic Pressure Rating: See PRESSURE, RATED DYNAMIC.

Easy Flo 45: Easy Flo 45 is a trademark of the Handy & Harman Company.

Elastic Deformation: Change of dimensions accompanying stress in the elastic range, original dimensions being restored upon release of stress.

Elastomer: Often referred to as rubber, is a high polymer that can be, or has been modified to a state exhibiting little plastic flow and quick recovery from an extending force.

Erosion: Destruction of metals or other materials by the abrasive action of moving fluids, or particles.

Extrusion: Conversion of an ingot slug or billet into lengths of uniform cross section by plastically forcing the metal through a die orifice having the desired cross sectional profile.

Fatigue/Endurance Limit: The maximum stress below which a material can presumably endure an infinite number of stress cycles.

Fatigue Fracture: The initiation of minute cracks, propagating into ultimate fracture under the application of repeated or fluctuating stresses having a maximum value less than the tensile strength of the material.

Ferrous Metal: A metal in which the major constituent is iron.

Fire Point: The temperature to which a fluid must be heated to *ignite* and *burn* for at least five seconds in the presence of air when a small flame is applied.

Glossary

Fitting: A connector or closure for fluid power lines and passages.

Flare Test: A test applied to tubing, involving a tapered expansion over a cone, in order to verify tube ductility and resistance to cracking during flaring operation.

Flaring: Forming an outward acute-angle flange on a tubular part.

Flash Point: The temperature to which a liquid must be heated to form a mixture with air that can be ignited *momentarily* by a flame.

Flow: Movement of fluid generated by pressure differences.

Flow, Laminar: A flow situation in which fluid moves in parallel lamina or streamlined layers.

Flow Lines: A fiber pattern, frequently observed in wrought metal, which indicates the manner in which the metal flowed during forming.

Flow Rate: The volume, mass or weight of a fluid passing through any conductor per unit of time.

Flow, Turbulent: A flow situation in which the fluid particles move in a random fluctuation manner. This is generally caused by too high fluid velocity.

Fluid Friction: Friction due to the viscosity of the fluid.

Fluid Power System: A system that transmits and controls power through the use of a pressurized fluid within an enclosed circuit.

Fluorocarbon Rubber: An elastomeric material which is extensively used for O-ring. Fluorocarbon (Viton) is recommended for higher temperatures than nitrile (Buna N) material.

Flux: In brazing, cutting, soldering or welding, material used to dissolve or facilitate the removal of oxides and other undesirable substances.

Folds: Defects in metals, usually on or near the surface caused by continued fabrication of overlapping surfaces.

Forgeability: Term used to describe the relative ability of materials to deform without rupture.

Forging: Plastically deforming metal, usually hot, into desired shapes with compressive force, with or without dies.

Forging Die: A forging whose shape is determined by impressions in specially prepared dies.

Free Machining: Denotes the machining characteristics of an alloy to which one or more ingredients have been introduced to produce small broken chips, lower power consumption, better surface finish and longer tool life.

Galling: Localized welding on mating surfaces of metal parts caused from excessive friction developed during the rubbing action that occurs during assembly.

Galvanic Corrosion: Corrosion resulting from the placing of two dissimilar metals in direct contact with each other then exposing them to an incompatible fluid or atmosphere.

Hammer, Liquid: Pressure and depression waves created by relatively rapid flow changes and transmitted through the system.

Handy Flux: Handy Flux is a trademark of the Handy & Harman Company.

Hardening: Increasing the hardness of a material by suitable treatment, usually involving heating and rapid cooling.

Hardness: Resistance of a material to scratching, abrasion, cutting or deformation.

Head, Pressure: The pressure due to the height of a column or body of fluid.

Heading: See COLD HEADING.

Hot Finishing/Hot Forming: A deformation operation performed at elevated temperature, usually above the recrystallization temperature of the metal.

Hydraulic Power: Power derived from flow rate and pressure differential of the fluid.

Hydraulics: Engineering science pertaining to liquid pressure and flow.

Hydrogen Embrittlement: A condition of low ductility in metals resulting from the absorption of hydrogen.

Hydropneumatics: Engineering science pertaining to the combination of hydraulic and pneumatic fluid power.

Impact Test: A single blow to determine the behavior of materials when subjected to high rates of loading, usually sudden and in the bending, tension or torsion mode. Charpy or Izod tests are typically used to measure materials' impact energy characteristics.

Inclusions: Nonmetallic materials in solid metallic matrix.

Intergranular Corrosion: A preferential corrosive attack at the grain boundaries of a metal.

LB2000: Registered Trademark of ITW.

Lubricant: Any substance used to reduce friction between two surfaces which are in contact.

MPG 2: Registered Trademark of Dubois Chemical Inc.

Machinability: The relative ease of machining a metal.

Machining: Removing material, in the form of chips, from work, usually through the use of a machine.

Malleability: The characteristic of metals that permits plastic deformation in compression without rupture.

Mandrel: (1) A metal bar around which other metal may be cast bent, formed, or shaped. (2) A rod used to retain the cavity in hollow metal products during working.

Mechanical Properties: The properties of a material that reveal its elastic and inelastic behavior under the application of force, thus indicating the material's suitability for mechanical applications. Examples of such properties are: tensile strength, elongation, modulus of elasticity, yield strength, reduction in area and fatigue limit.

Microhardness: The hardness of microscopic areas or of the individual microconstituents in a metal.

Microstructure: The structure of polished and etched metals as revealed by a microscope at a magnification greater than ten diameters.

Glossary

Mild Steel: Carbon steel with a maximum of .25 percent carbon.

Nitriding: A case hardening process conducted by the introduction of nitrogen into the surface of a solid ferrous alloy.

Nitrile (Buna N): A copolymer of butadiene and acrylonitrile. It is the elastomer most widely used to manufacture O-rings.

Nondestructive: Inspection or test by methods that do not destroy the part.

O-ring: A torus, or doughnut shaped object, generally made from elastomer and is used primarily for sealing.

Passivation: A process used to improve corrosive behavior of a metal by changing its chemically active surface to a much less reactive state.

Pipe: (1) The defect in wrought or cast products resulting from the central cavity formed by contraction in metal, especially ingots, during solidification. (2) A tubular metal product that includes iron pipe size (I.P.S.) and schedule number in its classification.

Pipe Thread, Dry Seal: Tapered pipe threads in which sealing is a function of root and crest interference.

Pitting: Forming small sharp cavities in a metal surface by corrosion, mechanical action or nonuniform electrodeposition.

Plastic Deformation: Deformation that does or will remain permanent in an element after removal of the stress that caused it.

Pneumatics: Engineering science pertaining to gaseous pressure and flow.

Port: A terminus of a passage in a component to which conductors can be connected.

Port, Pipe: A port which conforms to pipe thread standards.

Port, Straight Thread: A port which conforms to straight thread standards. It typically employs an O-ring compressed in a wedge-shaped cavity.

Power Supply, Fluid: Energy source which generates and maintains a flow of fluid under pressure.

Precipitation Hardening: Hardening caused by the precipitation of a constituent from a supersaturated solid solution.

Pressure: Force per unit area, usually expressed in pounds per square inch (psi).

Pressure, Absolute: The pressure above absolute zero, i.e., the sum of atmospheric pressure plus gage pressure.

Pressure, Atmospheric: Pressure exerted by the atmosphere at any specific location. [Sea level atmospheric pressure is approximately 14.7 pounds per square inch (about 1 bar)]

Pressure, Burst: The pressure which causes failure of, and consequential loss of fluid through the product envelope.

Pressure, Cyclic Test: A pressure range applied in cyclic endurance tests that are performed to help determine recommended working pressure.

Pressure, Differential (Pressure Drop): The difference in pressure between any two points of a system or a component.

Pressure, Gage: Pressure differential above or below ambient atmospheric pressure.

Pressure, Nominal: A pressure value assigned to a component or system for the purpose of convenient designation.

Pressure, Operating: See WORKING PRESSURE.

Pressure, Proof: The non-destructive test pressure, in excess of the maximum rated operating pressure, which causes no permanent deformation, external leakage, or other resulting malfunction.

Pressure, Rated Dynamic: The maximum fluctuating pressure load that a pressure containing envelope is capable of sustaining for a minimum of 1 million operating cycles without failure.

Pressure, Rated Static: The maximum pressure that a pressure containing envelope is capable of sustaining in an application not exceeding 30,000 operating cycles in a system free of pressure surges, shocks, vibration, temperature excursions, etc.

Pressure, Relief: The pressure at which the relief valve is set for actuation. This pressure is generally slightly higher than the system working pressure.

Pressure Shock: A pressure wave front which moves at a sonic velocity, due to sudden stoppage of fluid flow.

Pressure, Static: The pressure in a fluid at rest.

Pressure, Surge: The pressure increases resulting from pressure fluctuations in a hydraulic system.

Pressure, Working: The pressure at which the apparatus is being operated in a given application.

Pressure, Working Rated: The qualified operating pressure which is recommended for a system or a component by the manufacturer.

Proof Load: A pre-determined load, generally some multiple of the service load, to which a specimen or structure is submitted before acceptance for use.

Quenching: Rapid cooling method used in heat treating process.

Residual Stress: Stress existing in a body that is free of external forces or thermal gradients.

Rockwell Hardness Test: A test for determining the hardness of a material based upon the depth of penetration of a specified penetrator into the specimen.

Roughness: Relatively finely-spaced surface irregularities, the height, width and direction of which establish the predominant surface pattern.

STP: Distributed by First Brand Corp. Danbury, CT.

Scaling: (1) Forming a thick layer of oxidation products on metals at high temperatures. (2) Depositing water-insoluble constituents on a metal surface, as in cooling tubes and water boilers.

Seam: A fold or lap on the surface of a metal appearing as a crack, usually resulting from a defect obtained in casting or in working.

Segregation: Concentration of alloying elements in specific regions in a metallic object.

Glossary

Shear Strength: The load divided by the original cross-sectional area of a section separated by a shear force.

Sour Environment: Fluids containing water as a liquid and hydrogen sulfide, and may cause sulfide stress cracking (SSC) of susceptible materials.

Specific Gravity, Liquid: The ratio of the weight of a given volume of liquid to an equal volume of water.

Spot Facing: Machining in the mating component, a flat seat for a bolt head, nut, locknut or other similar element.

Springback: (1) The elastic recovery of metal after stressing. (2) The degree to which metal tends to return to its original shape or contour after undergoing a forming operation.

Stainless Steel: Basically, low carbon alloy steels containing at least 11.5% chromium. These steels are characterized by their high resistance to corrosion.

Static Pressure Rating: See pressure, rated static

Steel: An iron-based alloy, containing: manganese, usually carbon, and often other alloying elements.

Strain: A measure of the relative change in size or shape of a body. Example, linear strain is computed as the ratio of change in length to the original length.

Stress: The result of a force acting on a given surface area. Computed as the ratio of the applied force to the affected area.

Stress Corrosion Cracking (SCC): Fracture in a material resulting from the combined action of applied stress and corrosive environment.

Stress Raisers/Concentration: Changes in contour or discontinuities in structure that cause local increases in stress.

Stringer: In wrought materials, an elongated configuration of microconstituents or foreign material aligned in the direction of working.

Sulfide Stress: Brittle failure by cracking under the combined action of tensile stress and corrosion in the presence of water Cracking (SSC) and hydrogen sulfide.

Surge: A transient rise of pressure or flow.

Swaging: Forming a taper or a reduction on metal products such as rod and tubing by forging, squeezing or hammering.

Temperature, Ambient: The temperature of the environment in which the apparatus is working.

Tensile Strength: In tensile testing, the ratio of maximum load to original cross-sectional area.

Tensile Strength, Ultimate: The maximum stress that a material can withstand.

Torque: Turning effort (moment) applied to a component for fastening, tightening or assembling.

Torsion: A twisting action resulting in shear stresses and strain.

Toughness: Ability of a metal to absorb energy and deform without fracturing.

Tube: Hollow, cylindrical products having outside diameters that are not standardized for threading. Tubes are dimensionally classified in terms of their outside diameters and wall thicknesses.

Upsetting: See COLD HEADING.

Vacuum: Pressure less than ambient atmospheric pressure.

Vibra-Seal: Vibra-Seal is a registered trademark of Loctite Corporation.

Viscosity: A measure of the internal friction or the resistance of a fluid to flow.

Viton: Viton is a registered trademark of E.I. Du Pont de Nemours and Company.

Welding: Joining two or more pieces of metal by applying heat, pressure or both with or without filler metal, to produce a localized union through fusion or recrystallization across the interface.

Work Hardening: An increase in hardness and strength caused by plastic deformation at temperatures lower than the recrystallization range. (Same as Strain Hardening. See also, Cold Working.)

Working Pressure, Dynamic: See PRESSURE, RATED DYNAMIC.

Working Pressure, Static: See PRESSURE, RATED STATIC.

Yield Strength: The maximum stress that can be applied to a material, which upon removal, the material will return to approximately its original shape.