

YORK INTERNATIONAL CORPORATION	ENGINEERED SYSTEMS (ESG) <u>ENGINEERING STANDARD</u>	STANDARD NO.	C-51
		PAGE	1 OF 41
		DATE	03-28-04
	TERMINALS-WIRE FOR ELECTRICAL CONDUCTORS AND TERMINAL HOUSINGS	SUPERSEDES	07-10-03
		ECN	0703-3026
		PREPARED BY	L.N. Fair
		APPROVED BY	B.A. Smith

This standard, defining the requirements of materials to be furnished or services to be performed, is not subject to interpretation.

## 1. SCOPE

- 1.1. This standard covers solderless electrical wire terminals of the Slotted Spring Spade, Push-On, Ring Tongue, Pin and Socket types, terminal housings and inline and butt splices.
- 1.2. Tooling and Inspection: Tooling should be used as recommended by terminal manufacturer for the particular terminal being applied. (Information received with tooling should be retained, filed and followed as it contains the pertinent data required for quality application of terminals.) Inspection and certification of tooling and terminations should be conducted per information contained in AMP Inc. publication "Guidelines for User Certification of AMP Tooling HB5079 and Information Received with Tooling and Applicators".

## 2. RELATED STANDARDS

- 2.1. Terminals supplied under this standard shall conform to the following where applicable:
  - (a) Underwriters Laboratories, Inc., Standard UL 486A
  - (b) Military Standard MS25036 for the Pre-Insulated Terminals
  - (c) Underwriters Laboratories, Inc., Standard UL 310  
Electrical Quick-Connect Terminals
  - (d) CSA Standard C22.2 No 65; Wire Connectors
  - (e) CSA Standard C22.2 No. 153; Quick-Connect Terminals
  - (f) ESG Standard E-155: Equipment and Procedures for Dyeing  
Electrical Connector Housings

## 3. MATERIAL CHARACTERISTICS

- 3.1. Terminals shall be suitable for use with insulated stranded copper wire, plain or tinned.
- 3.2. The terminals shall be capable of being attached on the wire by crimping with special tools.
- 3.3. All terminals shall be brass, phosphor bronze or copper and shall be tin or gold plated as specified.
- 3.4. The various types of terminals and related housings covered under this standard are shown in the following paragraphs:
  - (a) Slotted Spring Spades - Paragraph 3.5
  - (b) Ring-tongue Terminals - Paragraph 3.6
  - (c) Push-On (Quick Connect) Terminal - Paragraph 3.7
  - (d) Wire Splices, Paragraph 3.8
  - (e) AMP Universal MATE-N-LOK Housings and Contacts -  
Paragraph 3.9
  - (f) AMP Commercial MATE-N-LOK Housings and Contacts -  
Paragraph 3.10

YORK INTERNATIONAL CORPORATION	ENGINEERED SYSTEMS (ESG) <u>ENGINEERING STANDARD</u>  TERMINALS-WIRE FOR ELECTRICAL CONDUCTORS AND TERMINAL HOUSINGS	STANDARD NO.	C-51
		PAGE	2 OF 41
		DATE	03-28-04
		SUPERSEDES	07-10-03
		ECN	0703-3026
		PREPARED BY	L.N. Fair
		APPROVED BY	B.A. Smith

3.4 (Continued)

- (g) AMP Mini-Universal MATE-N-LOK Housings and Contacts - Paragraph 3.11
- (h) AMP Mini-Universal MATE-N-LOK 2 Housings and Contacts - Paragraph 3.12
- (i) AMP Micro MATE-N-LOK Housing and Contacts - Paragraph 3.13
- (j) Single Leaf .156 Wire to Board Receptacle Housings and Contacts - Paragraph 3.14
- (k) MTA-156 IDC Connector - Closed end for 18 AWG wire - paragraph 3.15
- (l) AMP Mark II Econoseal J Series Housings and Contacts - Paragraph 3.16
- (m) Receptacles for Relay Sockets - Paragraph 3.17

3.5. Slotted Spring Spade Terminals:

- (a) General characteristics of slotted spring spade terminals shall be as shown in Table 3.5(a).

TABLE 3.5(a)

Detail Characteristics and Reference Tables

Wire Size Range AWG No.	AMP Designation		Insulation Material	Reference Table No.
	Type	Symbol		
22 to 10	Plasti-Grip	PG	Vinyl	3.5 (b)
22 to 10	Solistrand	SO	None	3.5 (c)

YORK INTERNATIONAL CORPORATION	ENGINEERED SYSTEMS (ESG) ENGINEERING STANDARD  TERMINALS-WIRE FOR ELECTRICAL CONDUCTORS AND TERMINAL HOUSINGS	STANDARD NO.	C-51
		PAGE	3 OF 41
		DATE	03-28-04
		SUPERSEDES	07-10-03
		ECN	0703-3026
		APPROVED BY	B.A. Smith

TABLE 3.5 (b)

Insulated Spring Spade Terminals (AMP Plasti-Grip)

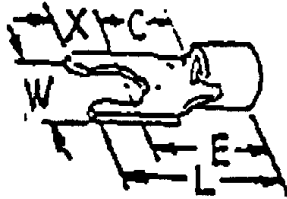

Wire Size AWG No.	Stud Size No.	Terminal Dimensions (in.)						Recom. Wire Strip Length	Part Number		Terminal Supplied
		Nominal Width "W" ±.008	Max. Length "L"	Max "E"	Min. Clear "C"	"X"	Wire Insulation (O.D.) Max.		AMP	York	
		22 - 16	6	0.234	0.811	0.666	0.250		0.140	0.140	
22 - 16	8	0.244	0.872	0.697	0.281	0.170	0.140	.203 - .234	53241-2	025-19407-000	T
22 - 16	8	0.375	0.921	0.746	0.281	0.170	0.200	.203 - .234	53950-3	025-19565-000	T
22 - 16	10	0.294	0.920	0.697	0.281	0.218	0.140	.203 - .234	53242-2	025-19408-000	T
22 - 16	10	0.294	0.969	0.746	0.281	0.218	0.200	.203 - .234	53242-6	025-19409-000	T
16 - 14	6	0.250	0.860	0.666	0.250	0.140	0.250	.203 - .234	52955-3	025-20519-000	T
16 - 14	6	0.250	0.811	0.666	0.250	0.140	0.170	.203 - .234	52955-1	025-18731-000	T
16 - 14	8	0.244	0.872	0.697	0.281	0.170	0.170	.203 - .234	53244-2	025-18732-000	T
16 - 14	8	0.244	0.921	0.746	0.281	0.170	0.250	.203 - .234	53244-4	025-19410-000	T
16 - 14	10	0.294	0.920	0.697	0.281	0.218	0.170	.203 - .234	53245-2	025-19376-000	T
16 - 14	10	0.406	0.969	0.746	0.281	0.218	0.250	.203 - .234	52957-3	N/A	T
16 - 14	1/4	0.437	1.102	0.759	0.345	0.338	0.150	.203 - .234	52423-2	025-19790-000**	T
12 - 10	8	0.312	1.052	0.877	0.276	0.170	0.250	.312 - .343	53247-2	025-19411-000	T
12 - 10	8	0.375	1.111	0.936	0.276	0.170	0.300	.312 - .343	52962-3	025-30995-000	T
12 - 10	10	0.406	1.100	0.877	0.276	0.218	0.200	.312 - .343	52963-1	N/A	T
12 - 10	10	0.375	1.278	0.965	0.305	0.308	0.300	.312 - .343	52475-3	N/A	T
12 - 10	1/4	0.437	1.289	0.946	0.345	0.338	0.250	.312 - .343	52433-1	025-19431-000	LP

\*\* = Material (Nylon)

Terminal Supplied T = Tape Mounted

LP = Loose Piece

All dimensions are for reference purposes

Primary dimensions ( ) are American standard inches, metric millimeter dimensions

**BOLD PART NUMBER FOR GLOBALLY DESIGNED UNITS**

YORK INTERNATIONAL CORPORATION	ENGINEERED SYSTEMS (ESG) ENGINEERING STANDARD  TERMINALS-WIRE FOR ELECTRICAL CONDUCTORS AND TERMINAL HOUSINGS	STANDARD NO.	C-51
		PAGE	4 OF 41
		DATE	03-28-04
		SUPERSEDES	07-10-03
		ECN	0703-3026
		APPROVED BY	B.A. Smith

TABLE 3.5 (c)

Non-Insulated Spring Spade Terminals (AMP Solistrand)

Wire Size AWG No.	Stud Size No.	Terminal Dimensions (in.)					Recom. Wire Strip Length	Part Number		Terminal Supplied
		Nominal Width "W"	Max. Length "L"	Max "E"	Min. Clear "C"	"X"		AMP	York	
		22 - 16	6	0.234	0.576	0.431		0.250	0.140	
22 - 16	8	0.244	0.637	0.462	0.281	0.170	1/4	53831-2	025-19433-000	T
22 - 16	10	0.294	0.685	0.462	0.281	0.218	1/4	53832-2	025-19434-000	T
16 - 14	6	0.250	0.576	0.431	0.250	0.140	1/4	53123-2	025-19435-000	T
16 - 14	8	0.244	0.637	0.462	0.281	0.170	1/4	53833-2	025-18579-000	T
16 - 14	10	0.294	0.685	0.462	0.281	0.218	1/4	53834-2	025-19436-000	T
<b>16</b> [1.5]	<b>1/4</b> [M6]	<b>0.437</b> [11.1]	<b>0.822</b> [20.88]	<b>0.536</b> [13.61]	<b>0.350</b> [8.89]	<b>0.281</b> [7.14]	<b>1/4</b> [6.35]	<b>53875-2</b>	<b>025-34201-000</b>	<b>T</b>
12 - 10	6	0.250	0.636	0.452	0.174	0.179	5/16	53126-2	N/A	T
12 - 10	8	0.375	0.729	0.554	0.276	0.170	5/16	53127-2	N/A	T
12 - 10	10	0.312	0.777	0.554	0.276	0.218	5/16	53836-2	025-19438-000	T
12 - 10	1/4	0.375	0.902	0.616	0.338	0.281	5/16	53837-2	025-19439-000	T
<b>12-10</b> [4-6]	<b>1/4</b> [M6]	<b>0.375</b> [9.53]	<b>0.902</b> [22.91]	<b>0.616</b> [15.65]	<b>0.358</b> [8.59]	<b>0.281</b> [7.14]	<b>1/4</b> [6.35]	<b>53837-2</b>	<b>025-33797-000</b>	<b>T</b>

Terminal Supplied T = Tape Mounted  
LP = Loose Piece

All dimensions are for reference purposes  
Primary dimensions ( ) are American standard inches, metric millimeter dimensions are in brackets [ ]  
**BOLD PART NUMBER FOR GLOBALLY DESIGNED UNITS**

3.6. Ring-Tongue Terminals:

Tables 3.6(a) to 3.6(f) incl. give dimensions, part numbers and other information on Ring-Tongue Type Terminals.

TABLE 3.6 (a)

Detail Characteristics and Reference Tables

Wire Size Range AWG No.	AMP Designation	Insulation Material	Reference Table No.
22 thru 2/0	Plastic-Grip	Vinyl	3.6 (b)
26 thru 10	Diamond Grip	Nylon	3.6 (c)
8 thru 2/0	Terminyl	Nylon	3.6 (d)
26 thru 2/0	Solistrand	None	3.6 (e)

YORK INTERNATIONAL CORPORATION	ENGINEERED SYSTEMS (ESG) ENGINEERING STANDARD	STANDARD NO.	C-51
	TERMINALS-WIRE FOR ELECTRICAL CONDUCTORS AND TERMINAL HOUSINGS	PAGE	5 OF 41
		DATE	03-28-04
		SUPERSEDES	07-10-03
		ECN	0703-3026
		PREPARED BY	L.N. Fair
	APPROVED BY	B.A. Smith	

TABLE 3.6(b)  
Insulated Ring-Tongue Terminals (AMP Plasti-Grip)

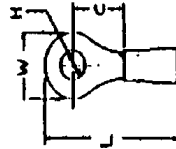

Wire Size AWG No.	Stud Size No.	Terminal Dimensions (in.)						Recommend. Wire Strip Length	Part Number		Term. Supp.
		** Hole "H"	+/- .008 Width "W"	Max. Length "L"	Min. Clear "C"	Max. Washer Radius	Wire Insul. (O.D.) Max.		AMP	York	
22 - 16	6	0.145	0.218	0.684	0.156		0.140	.203 - .234	1-34142-1	025-07172-000	T
22 - 16	6	0.145	0.312	0.856	0.281		0.140	.203 - .234	2-34147-1	025-30981-000	T
22 - 16	8	0.171	0.312	0.856	0.281		0.140	.203 - .234	2-34148-1	025-30983-000	T
22 - 16	10	0.197	0.281	0.809	0.250		0.170	.203 - .234	2-35451-1	025-10254-000	T
22 - 16	1/4	0.265	0.469	1.090	0.437		0.140	.203 - .234	2-34150-1	025-18946-000	T
16 - 14	6	0.145	0.343	0.871	0.281		0.170	.203 - .234	2-34159-1	025-10533-000	T
16 - 14	8	0.171	0.343	0.871	0.281		0.170	.203 - .234	2-34160-1	025-10865-000	T
16 - 14	10	0.197	0.343	0.871	0.281		0.170	.203 - .234	2-34161-1	025-11083-000	T
16 - 14	10	0.197	0.343	1.406	0.281		.200 (*)	.203 - .234	2-34823-1	025-11936-000	T
16 - 14	0.25	0.265	0.469	1.090	0.437		0.170	.203 - .234	34162	025-21101-000	LP
16 - 14	0.25	0.265	0.469	1.090	0.437		0.170	.203 - .234	2-34162-1	025-30997-000	T
16 - 14	0.3125	0.328	0.469	1.090	0.437		0.170	.203 - .234	34163	025-29904-000	LP
<b>16 - 14</b> <b>[1.5 - 2.5]</b>	<b>5/16</b> <b>[M8]</b>	<b>0.328</b> <b>[8.33]</b>	<b>0.469</b> <b>[11.91]</b>	<b>1.090</b> <b>[26.68]</b>	<b>0.437</b> <b>[11.09]</b>		<b>0.170</b> <b>[4.32]</b>	<b>.203 - .234</b> <b>[5.15 - 5.94]</b>	<b>34163</b>	<b>025-38127-000</b>	<b>LP</b>
16 - 14	0.375	0.391	0.531	1.230	0.546		0.170	.203 - .234	34164	025-29612-000	LP
16 - 14	3/8*	0.390	0.750	1.594	0.625		0.200	.203 - .234	34826	025-32956-000	LP
<b>16 - 14</b> <b>[1.5 - 2.5]</b>	<b>10</b> <b>[M6]</b>	<b>0.197</b> <b>[5.00]</b>	<b>0.343</b> <b>[8.71]</b>	<b>1.407</b> <b>[26.57]</b>	<b>0.281</b> <b>[7.14]</b>		<b>.200*</b> <b>[5.08]</b>	<b>.203 - .234</b> <b>[5.15 - 5.94]</b>	<b>2-34823-1</b>	<b>025-34056-000</b>	<b>T</b>
12 - 10	6	0.145	0.281	0.953	0.219		0.250	.312 - .343	2-34852-1	025-32520-000	T
12 - 10	8	0.171	0.375	1.094	0.302		0.250	.312 - .343	2-34853-1	025-08499-000	T
<b>12 - 10</b> <b>[4 - 6]</b>	<b>8</b> <b>[M4]</b>	<b>0.171</b> <b>[4.34]</b>	<b>0.375</b> <b>[9.52]</b>	<b>1.098</b> <b>[27.89]</b>	<b>0.302</b> <b>[7.67]</b>		<b>0.250</b> <b>[6.35]</b>	<b>.312 - .343</b> <b>[7.92 - 8.71]</b>	<b>2-34853-1</b>	<b>025-34091-000</b>	<b>T</b>
12 - 10	10	0.197	0.375	1.083	0.302		0.250	.312 - .343	2-34854-1	025-08477-000	T
12 - 10	12, 14, 1/4	0.265	0.531	1.327	0.468		0.250	.312 - .343	2-34855-1	025-08787-000	T
12 - 10	5/16	0.328	0.531	1.327	0.468		0.250	.312 - .343	2-34856-1	025-28972-000	T
12 - 10	3/8	0.390	0.593	1.421	0.531		0.230	.312 - .343	2-34173-1	025-28973-000	T
12 - 10	1/2	0.515	0.750	1.594	0.625		0.250	5/16	2-34837-4	025-33728-000	T
<b>12 - 10</b> <b>[4 - 6]</b>	<b>1/2</b> <b>[M12]</b>	<b>0.515</b> <b>[13.08]</b>	<b>0.750</b> <b>[19.05]</b>	<b>1.594</b> <b>[40.49]</b>	<b>0.625</b> <b>[15.88]</b>		<b>0.250</b> <b>[6.35]</b>	<b>5/16</b> <b>[7.93]</b>	<b>2-34837-4</b>	<b>025-34092-000</b>	<b>T</b>
8	3/8	0.390	0.587	1.696		0.500	0.360	.328 - .359	52291-1	025-30412-000	LP
8	1/4	0.265	0.478	1.600		0.437	0.330	.328 - .359	52041-3	025-29935-000	LP
6	3/8	0.390	0.625	1.906		0.515	0.450	.609 - .641	52264-1	025-30418-000	LP
<b>6</b> <b>[16]</b>	<b>3/8</b> <b>[M10]</b>	<b>0.390</b> <b>[9.91]</b>	<b>0.625</b> <b>[15.87]</b>	<b>1.906</b> <b>[48.41]</b>		<b>0.515</b> <b>[13.08]</b>	<b>0.450</b> <b>[11.43]</b>	<b>.609 - .641</b> <b>[15.46-16.28]</b>	<b>52264-1</b>	<b>025-38129-000</b>	<b>LP</b>
6	1/4	0.265	0.500	1.869		0.515	0.360	.609 - .641	52042-3	025-28943-000	LP
6	10	0.197	0.500	1.869		0.515	0.340	.609 - .641	52042-5	025-30416-000	LP
4	3/8	0.390	0.679	2.014		0.531	0.450	.609 - .641	52266-4	025-30415-000	LP
<b>4</b> <b>[25]</b>	<b>3/8</b> <b>[M10]</b>	<b>0.390</b> <b>[9.91]</b>	<b>0.679</b> <b>[17.24]</b>	<b>2.014</b> <b>[51.15]</b>		<b>0.531</b> <b>[13.48]</b>	<b>0.450</b> <b>[11.43]</b>	<b>.609 - .641</b> <b>[15.46-16.28]</b>	<b>52266-4</b>	<b>025-38130-000</b>	<b>LP</b>
4	1/4	0.265	0.546	1.948		0.531	0.450	.609 - .641	52043-3	025-28681-000	LP
4	10	0.197	0.546	1.948		0.531	0.450	.609 - .641	52043-2	025-30414-000	LP
2	3/8	0.390	0.711	2.089		0.578	0.560	.453 - .484	52044-5	025-30411-000	LP
2	1/4	0.265	0.675	2.071		0.578	0.560	.453 - .484	52267-1	025-28682-000	LP
2	5/16	0.328	0.711	2.089		0.578	0.560	.453 - .484	52044-4	025-29649-000	LP
1/0	3/8	0.390	0.807	2.447		0.625	0.665	.735 - .859	52045-5	025-30413-000	LP
1/0	5/16	0.328	0.807	2.447		0.625	0.684	.735 - .859	52045-1	025-28685-000	LP

\* = indicates heavy duty terminals

Terminal Supplied: T = Tape Mounted

\*\* = "H" Hole Tolerance

LP = Loose Piece

Stud Size ≥ 1/4 = ± .005

Stud Size ≤ 1/4 = ± .003

All Dimensions are for reference purposes only.

Primary Dimensions are American standard inches, Metric millimeter dimensions are in brackets [ ].

**Bold part Numbers are for globally designed units.**

YORK INTERNATIONAL CORPORATION	ENGINEERED SYSTEMS (ESG) ENGINEERING STANDARD  TERMINALS-WIRE FOR ELECTRICAL CONDUCTORS AND TERMINAL HOUSINGS	STANDARD NO.	C-51
		PAGE	6 OF 41
		DATE	03-28-04
		SUPERSEDES	07-10-03
		ECN	0703-3026
		PREPARED BY	L.N. Fair
APPROVED BY	B.A. Smith		

TABLE 3.6(c)

Insulated Ring-Tongue Terminals (AMP Pre-Insulated Diamond Grip - PIDG)

for Military Applications

Wire Size AWG No.	** Stud Size No.	Terminal Dimensions (in.)						Recom. Wire Strip Length	Part Number		Terminal Supplied
		Hole "H"	+/- .008 Width "W"	Max. Length "L"	Min. Clear "C"	Max. Washer Radius	Wire Insulation (O.D.) Max.		AMP	York	
22 - 16	6	0.145	0.218	0.672	0.156		0.140	.203 - .234	36150	025-06956-000	LP
22 - 16	6	0.145	0.312	0.797	0.250		0.140	.203 - .234	36152	025-28964-000	LP
22 - 16	8	0.171	0.312	0.844	0.281		0.140	.203 - .234	31890	025-09018-000	LP
22 - 16	10	0.197	0.281	0.844	0.281		0.140	.203 - .234	36154	025-09043-000	LP
22 - 16	1/4	0.265	0.469	1.078	0.437		0.125	.203 - .234	320571	025-28689-000	LP
16 - 14	6	0.145	0.343	0.859	0.281		0.150	.203 - .234	36157	025-14663-000	LP
16 - 14	6	0.145	0.250	0.703	0.171		0.150	.203 - .234	320561	025-28965-000	LP
16 - 14	6	0.145	0.281	0.953	0.219		.250 (*)	.203 - .234	35634	025-18153-000	LP
16 - 14	8	0.171	0.343	0.859	0.281		0.170	.203 - .234	320565	025-13230-000	LP
16 - 14	10	0.197	0.343	0.859	0.281		0.150	.203 - .234	320574	025-04811-000	LP
16 - 14	10	0.197	0.343	0.859	0.281		0.170	.203 - .234	36160	025-05628-000	LP
16 - 14	10	0.197	0.343	1.046	0.281		.250 (*)	.203 - .234	34805	025-09650-000	LP
16 - 14	1/4	0.265	0.531	1.296	0.437		.250 (*)	.203 - .234	34806	025-08788-000	LP

\* = Indicates heavy duty terminals

\*\* "H" Hole Tolerance

Stud Size  $\geq 1/4 = \pm .005$

Stud Size  $\leq 1/4 = \pm .003$

Terminal Supplied T = Tape Mounted

LP = Loose Piece

All dimensions are for reference purposes

Primary dimensions ( ) are American standard inches, metric millimeter dimensions

**BOLD PART NUMBER FOR GLOBALLY DESIGNED UNITS**

YORK INTERNATIONAL CORPORATION	ENGINEERED SYSTEMS (ESG) ENGINEERING STANDARD  TERMINALS-WIRE FOR ELECTRICAL CONDUCTORS AND TERMINAL HOUSINGS	STANDARD NO.	C-51
		PAGE	7 OF 41
		DATE	03-28-04
		SUPERSEDES	07-10-03
		ECN	0703-3026
		APPROVED BY	B.A. Smith

TABLE 3.6(d)

Insulated Ring-Tongue Terminals (AMP Terminal)

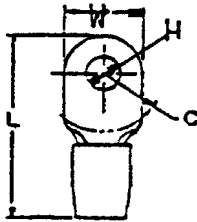

Wire Size AWG No.	Stud Size No.	Terminal Dimensions					Recom. Wire Strip Length	Part Number*	
		Hole "H" ±.005	Width "W" ±.008	Max. Length "L"	Max. Washer Radius "C"	Wire Insulation (O.D.) Max.		AMP	York
2	5/16	0.328	0.711	2.063	0.578	.473 max.	.453 - .484	324112	025-28684-00
1/0	1/4	0.265	0.807	2.426	0.625	.580 max.	.735 - .859	324056	025-28683-00

\* = Indicates heavy duty

All dimensions are for reference purposes

Primary dimensions ( ) are American standard inches, metric millimeter dimensions are in

**BOLD PART NUMBER FOR GLOBALLY DESIGNED**

INTENT

YORK INTERNATIONAL CORPORATION	ENGINEERED SYSTEMS (ESG) ENGINEERING STANDARD  TERMINALS-WIRE FOR ELECTRICAL CONDUCTORS AND TERMINAL HOUSINGS	STANDARD NO.	C-51
		PAGE	8 OF 41
		DATE	03-28-04
		SUPERSEDES	07-10-03
		ECN	0703-3026
		APPROVED BY	B.A. Smith

TABLE 3.6(e)

Non-insulated Ring-Tongue Terminals (AMP Solistrand)

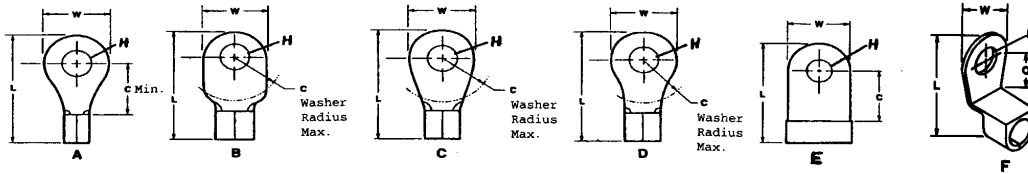

Wire Size AWG No.	Stud Size No.	Style	Terminal Dimensions (in.)				Recommend. Wire Strip Length	Part Number		Term. Supp.
			Hole "H"	Width "W"	Max. Length "L"	Min. Clear "C"		AMP	York	
22 - 16	10	A	0.197	0.312	0.621	0.281	1/4	2-34112-2	025-08803-000	T
16 - 14	10	A	0.197	0.343	0.636	0.281	1/4	2-34123-1	025-11595-000	T
16 - 14	12, 14, 1/4	A	0.265	0.469	0.855	0.434	1/4	2-34124-1	025-11164-000	T
16 - 14	8	A	0.171	0.343	0.636	0.281	1/4	2-34122-1	025-04475-000	T
12 - 10	6	A	0.145	0.375	0.765	0.302	5/16	2-33456-1	025-32551-000	T
12 - 10	8	A	0.171	0.375	0.765	0.302	5/16	2-32994-1	025-12611-000	T
12 - 10	10	A	0.197	0.375	0.765	0.302	5/16	2-33457-2	025-04474-000	T
12 - 10	1/4	A	0.265	0.531	1.004	0.468	5/16	2-33458-3		T
12 - 10	1/4	A	0.265	0.531	1.004	0.468	5/16	2-33458-3	025-33794-000	T
12 - 10	7/16	A	0.453				5/16		025-33787-000	T
12 - 10	1/2	A	0.515	0.750	1.271	0.625	5/16	2-35135-2	025-33789-000	LP
8	10	B	0.197	0.469	0.933	0.359	11/32	2-33460-2		T
8	1/4	B	0.265	0.469	0.933	0.359	11/32	2-33461-2	025-04473-000	T
8	1/4	B	0.265	0.469	0.933	0.359	11/32	2-33461-2	025-33792-000	T
8	3/8	B	0.390	0.594	1.168	0.531	11/32	33463	025-15143-000	LP
8	3/8	B	0.453	0.594	1.168	0.531	11/32	33463	025-38131-000	LP
8	7/16	B	0.453				11/32		025-33786-000	LP
8	1/2	B	0.515	1.250	1.965	1.000	11/32	35664	025-33788-000	LP
6	1/4	B	0.265	0.625	1.246	0.531	13/32	2-33465-1	025-33799-000	T
6	7/16	B	0.453	0.625	1.246	0.531	13/32	320745	025-26298-000*	LP
6	7/16	B	0.453	0.625	1.246	0.531	13/32	320745	025-34039-000	LP
6	1/2	B	0.515	0.875	1.840	1.000	13/32	320344	025-34049-000	LP
4	1/4	B	0.265	0.500	1.199	0.437	17/32	31811	025-25957-000	LP
4	1/4	B	0.265	0.500	1.199	0.437	17/32	31811	025-33791-000	LP
4	7/16	A	0.453	0.656	1.314	0.516	17/32	320743	025-32934-000	LP
4	7/16	A	0.453	0.656	1.314	0.516	17/32	320743	025-34040-000	LP
4	1/2	B	0.515	0.875	1.902	1.000	17/32	327175	025-25153-000	LP
4	1/2	B	0.515	0.875	1.902	1.000	17/32	327175	025-34050-000	LP

\* = Not recommended for new design

Terminal Supplied: T = Tape Mounted  
LP = Loose Piece

All Dimensions are for reference purposes only.  
Primary Dimensions are American standard inches, Metric millimeter dimensions are in brackets [ ].

**Bold part Numbers are for globally designed units.**

Continued on next page...

YORK INTERNATIONAL CORPORATION	ENGINEERED SYSTEMS (ESG) ENGINEERING STANDARD	STANDARD NO.	C-51
	TERMINALS-WIRE FOR ELECTRICAL CONDUCTORS AND TERMINAL HOUSINGS	PAGE	9 OF 41
		DATE	03-28-04
		SUPERSEDES	07-10-03
		ECN	0703-3026
		PREPARED BY	L.N. Fair
		APPROVED BY	B.A. Smith

TABLE 3.6(e) (Cont'd.)

Wire Size AWG No.	Stud Size No.	Style	Hole "H"	Terminal Max. Width "W"	Dimensions (in.)		Recom. Wire Strip Length	Part Number		Terminal Supplied
					Max. Length "L"	Max. Clear "C"		AMP	York	
2	1/4	C	0.265	0.625	1.527	0.531	17/32	320383	025-35939-000	LP
<b>2</b>	<b>1/4</b>	<b>C</b>	<b>0.265</b>	<b>0.625</b>	<b>1.527</b>	<b>0.531</b>	<b>17/32</b>	<b>320383</b>	<b>025-37807-000</b>	<b>LP</b>
[35]	[M6]		[6.73]	[15.88]	[38.79]	[13.49]	[13.49]			
2	5/16	D	0.328	0.890	1.657	0.531	17/32	35183	025-35941-000	LP
<b>2</b>	<b>5/16</b>	<b>D</b>	<b>0.328</b>	<b>0.890</b>	<b>1.657</b>	<b>0.531</b>	<b>17/32</b>	<b>35183</b>	<b>025-38128-000</b>	<b>LP</b>
[35]	[M8]		[8.33]	[22.61]	[42.09]	[13.49]	[13.49]			
2	3/8	C	0.390	0.890	1.657	0.531	17/32	35184	025-20913-000	LP
2	7/16	C	0.453	0.890	1.657	0.531	17/32	320741	025-25152-000	LP
<b>2</b>	<b>7/16</b>	<b>C</b>	<b>0.453</b>	<b>0.890</b>	<b>1.657</b>	<b>0.531</b>	<b>17/32</b>	<b>320741</b>	<b>025-34041-000</b>	<b>LP</b>
[35]	[M11]		[11.51]	[22.61]	[42.09]	[13.49]	[13.49]			
2	3/8	C	0.390	0.890	1.657	0.531	17/32	35184	025-34401-000	LP
<b>2</b>	<b>3/8</b>	<b>C</b>	<b>0.390</b>	<b>0.890</b>	<b>1.657</b>	<b>0.531</b>	<b>17/32</b>	<b>35184</b>	<b>025-34401-000</b>	<b>LP</b>
[35]	[M10]		[9.91]	[22.61]	[42.09]	[13.49]	[13.49]			
2	1/2	C	0.515	0.890	1.657	0.531	17/32	35185	025-34515-000	LP
<b>2</b>	<b>1/2</b>	<b>C</b>	<b>0.515</b>	<b>0.890</b>	<b>1.657</b>	<b>0.531</b>	<b>17/32</b>	<b>35185</b>	<b>025-34051-000</b>	<b>LP</b>
[35]	[M12]		[13.08]	[22.61]	[42.09]	[13.49]	[13.49]			
1	1/2	C	0.515	0.875	1.956	0.625	3/4	36919	025-34052-000	LP
<b>1</b>	<b>7/16</b>	<b>D</b>	<b>0.453</b>	<b>0.875</b>	<b>1.956</b>	<b>0.625</b>	<b>3/4</b>	<b>36918</b>	<b>025-34042-000</b>	<b>LP</b>
[50]	[M12]		[13.08]	[22.23]	[49.68]	[15.88]	[19.05]			
<b>1</b>	<b>7/16</b>	<b>D</b>	<b>0.453</b>	<b>0.875</b>	<b>1.956</b>	<b>0.625</b>	<b>3/4</b>	<b>36918</b>	<b>025-34042-000</b>	<b>LP</b>
[50]	[M11]		[11.51]	[22.23]	[49.68]	[15.88]	[19.05]			
1/0	1/4	D	0.265	0.875	1.956	0.625	3/4	36915	025-25950-000	LP
<b>1/0</b>	<b>1/4</b>	<b>D</b>	<b>0.265</b>	<b>0.875</b>	<b>1.956</b>	<b>0.625</b>	<b>3/4</b>	<b>36915</b>	<b>025-37806-000</b>	<b>LP</b>
[50]	[M6]		[6.73]	[22.23]	[49.68]	[15.88]	[19.05]			
1/0	5/16	D	0.328	0.875	1.956	0.625	3/4	36916	025-20524-000	LP
1/0	3/8	D	0.390	0.875	1.956	0.625	3/4	36917	025-20525-000	LP
<b>1/0</b>	<b>3/8</b>	<b>D</b>	<b>0.390</b>	<b>0.875</b>	<b>1.956</b>	<b>0.625</b>	<b>3/4</b>	<b>36917</b>	<b>025-37802-000</b>	<b>LP</b>
[50]	[M10]		[9.91]	[22.23]	[49.68]	[15.88]	[19.05]			
1/0	7/16	D	0.453	0.875	1.956	0.625	3/4	36918	025-25150-000	LP
<b>1/0</b>	<b>7/16</b>	<b>D</b>	<b>0.453</b>	<b>0.875</b>	<b>1.956</b>	<b>0.625</b>	<b>3/4</b>	<b>36918</b>	<b>025-34043-000</b>	<b>LP</b>
[50]	[M11]		[11.51]	[22.23]	[49.68]	[15.88]	[19.05]			
1/0	1/2	C	0.515	0.875	1.956	0.625	3/4	36919	025-34514-000	LP
<b>1/0</b>	<b>1/2</b>	<b>C</b>	<b>0.515</b>	<b>0.875</b>	<b>1.956</b>	<b>0.625</b>	<b>3/4</b>	<b>36919</b>	<b>025-33785-000</b>	<b>LP</b>
[50]	[M12]		[13.08]	[22.23]	[49.68]	[15.88]	[19.05]			
2/0	1/4	D	0.265	0.926	1.930	0.625	3/4	321869	025-38530-000	LP
<b>2/0</b>	<b>1/4</b>	<b>D</b>	<b>0.265</b>	<b>0.926</b>	<b>1.930</b>	<b>0.625</b>	<b>3/4</b>	<b>321869</b>	<b>025-38530-000</b>	<b>LP</b>
[70]	[M6]		[6.73]	[23.52]	[49.02]	[15.88]	[19.05]			
2/0	5/16	D	0.328	0.926	1.930	0.625	3/4	321870	025-32946-000	LP
2/0	3/8	D	0.390	0.926	1.930	0.625	3/4	321871	025-17710-000	LP
<b>2/0</b>	<b>3/8</b>	<b>D</b>	<b>0.390</b>	<b>0.926</b>	<b>1.930</b>	<b>0.625</b>	<b>3/4</b>	<b>321871</b>	<b>025-37803-000</b>	<b>LP</b>
[70]	[M10]		[9.91]	[23.52]	[49.02]	[15.88]	[19.05]			
2/0	7/16	D	0.453	0.926	1.930	0.625	3/4	321872	025-25151-000	LP
<b>2/0</b>	<b>7/16</b>	<b>D</b>	<b>0.453</b>	<b>0.926</b>	<b>1.930</b>	<b>0.625</b>	<b>3/4</b>	<b>321872</b>	<b>025-34044-000</b>	<b>LP</b>
[70]	[M11]		[11.51]	[23.52]	[49.02]	[15.88]	[19.05]			
2/0	1/2	D	0.515	0.926	1.930	0.625	3/4	321873	025-33729-000	LP
<b>2/0</b>	<b>1/2</b>	<b>D</b>	<b>0.515</b>	<b>0.926</b>	<b>1.930</b>	<b>0.625</b>	<b>3/4</b>	<b>321873</b>	<b>025-34053-000</b>	<b>LP</b>
[70]	[M12]		[13.08]	[23.52]	[49.02]	[15.88]	[19.05]			
2/0	1/4	F	.265	.946	1.930	.432	3/4	324028	025-387740-000	LP
<b>2/0</b>	<b>1/4</b>	<b>F</b>	<b>.265</b>	<b>.946</b>	<b>1.930</b>	<b>.432</b>	<b>3/4</b>	<b>324028</b>	<b>025-387740-000</b>	<b>LP</b>
[70]	[M6]		[6.73]	[24.03]	[49.02]	[10.97]	[19.05]			
2/0	3/8	F	.390	.926	1.687	.531	3/4	322912	025-38528-000	LP
<b>2/0</b>	<b>3/8</b>	<b>F</b>	<b>.390</b>	<b>.926</b>	<b>1.687</b>	<b>.531</b>	<b>3/4</b>	<b>322912</b>	<b>025-38528-000</b>	<b>LP</b>
[70]	[M10]		[9.91]	[23.52]	[42.85]	[13.49]	[19.05]			
2/0	5/8	F	0.656	1.270	2.328	1.000	3/4	696311-1	025-35967-000	LP
3/0	3/8	D	0.390	1.020	2.112	0.625	3/4	321875	025-31736-000	LP
<b>3/0</b>	<b>3/8</b>	<b>D</b>	<b>0.390</b>	<b>1.020</b>	<b>2.112</b>	<b>0.625</b>	<b>3/4</b>	<b>321875</b>	<b>025-34459-000</b>	<b>LP</b>
[95]	[M10]		[9.91]	[25.91]	[53.64]	[15.88]	[19.05]			
3/0	7/16	D	0.453	1.020	2.112	0.625	3/4	321876	025-26296-000	LP
<b>3/0</b>	<b>7/16</b>	<b>D</b>	<b>0.453</b>	<b>1.020</b>	<b>2.112</b>	<b>0.500</b>	<b>3/4</b>	<b>321876</b>	<b>025-34045-000</b>	<b>LP</b>
[95]	[M11]		[11.51]	[25.91]	[53.64]	[12.70]	[19.05]			
3/0	1/2	D	0.515	1.020	2.112	0.625	3/4	321877	025-31737-000	LP
<b>3/0</b>	<b>1/2</b>	<b>D</b>	<b>0.515</b>	<b>1.020</b>	<b>2.112</b>	<b>0.500</b>	<b>3/4</b>	<b>321877</b>	<b>025-34107-000</b>	<b>LP</b>
[95]	[M12]		[13.08]	[25.91]	[53.64]	[12.70]	[19.05]			
3/0	5/8	F	0.656	1.270	2.335	0.925	3/4	696312-1	025-35968-000	LP

\* = Not Recommended for New Design

Terminal Supplied T = Tape Mounted

LP = Loose Piece

All Dimensions are for reference purposes only.

Primary Dimensions are American standard inches, Metric millimeter dimensions are in brackets [ ].

**Bold part Numbers are for globally designed units.**

Continued on next page..



YORK INTERNATIONAL CORPORATION	ENGINEERED SYSTEMS (ESG) ENGINEERING STANDARD  TERMINALS-WIRE FOR ELECTRICAL CONDUCTORS AND TERMINAL HOUSINGS	STANDARD NO.	C-51
		PAGE	11 OF 41
		DATE	03-28-04
		SUPERSEDES	07-10-03
		ECN	0703-3026
		PREPARED BY	L.N. Fair
		APPROVED BY	B.A. Smith

TABLE 3.6(f)

Hole and Stud Sizes

Ring-Tongue Terminals					
Stud Size		Dia. Hole (H) +/- .003" To Match	Stud Size		Dia. Hole (H) +/- .005" To Match
No.	Dia.		No.	Dia.	
1	0.073	0.093	12	0.216	0.265
2	0.086	0.093	14	0.242	0.265
3	0.099	0.119	1/4	0.250	0.265
4	0.112	0.119	5/16	0.312	0.328
5	0.125	0.145	3/8	0.375	0.391
6	0.138	0.145	7/16	0.437	0.453
8	0.164	0.171	1/2	0.500	0.515
10	0.190	0.197			

All dimensions are for reference purposes only.

3.7 Push-On (Quick Connect) Terminals:

- (a) The Push-On Type Terminals are crimped onto stranded wire with special tools and then slipped over a flat male tab which is attached to the device being connected.
- (1) The matching male tab of all Push-On Type Terminals shall comply with Underwriters Laboratories Standard UL310.
- (b) The general characteristics of Push-on Type Terminals shall be as shown in Table 3.7(b).

TABLE 3.7(b)

Item	Type	AMP Faston Series No.	Matching Male Tab	Reference Table No.
A	Straight	250	.250 x .032	3.7(c) & (d)
B	Flag (90 degree angle)	250	.250 x .032	3.7(c) & (d)
C	Straight	187	.187 x .020	3.7(e)
D	Adapters	250	.250 x .032	3.7(f)

All dimensions are for reference purposes only

- (c) Tables 3.7(c) to 3.7(f) incl. and figures below, given dimensions, part numbers and detail information on the Push-On Type Terminals.

YORK INTERNATIONAL CORPORATION	ENGINEERED SYSTEMS (ESG) ENGINEERING STANDARD  TERMINALS-WIRE FOR ELECTRICAL CONDUCTORS AND TERMINAL HOUSINGS	STANDARD NO.	C-51
		PAGE	12 OF 41
		DATE	03-28-04
		SUPERSEDES	07-10-03
		ECN	0703-3026
		APPROVED BY	B.A. Smith

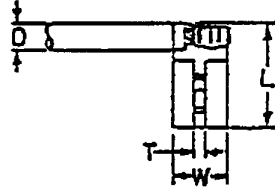
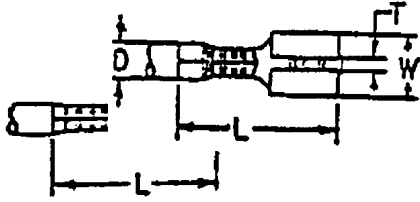

Straight Push-On

Flag Push-On

w/o Insulation Support

w/ Insulation Support

Straight Push-On

w/ Insulation Support

TABLE 3.7(c)

AMP Faston Series 250 Terminals - ESG Standard Types

FITS .250" x .032" MALE TAB								
Type	Wire Size AWG No.	Terminal Dimensions (in.)				Recom. Wire Strip Length	Part Number	
		Width Inside "T"	Width Outside "W"	Length Overall "L"	Wire Insulation (O.D.) * "D"		AMP	York
Straight	22 - 18	0.090	0.300	0.750	.090 - .130	1/4	41772	025-06874-000
Straight	18 - 14	0.065	0.300	0.755	.120 - .170***	1/4	41274	025-06642-000
Straight	18 - 14	0.124	0.318	0.750	.120 - .170	1/4	41832	025-14291-000
Straight	16 - 12	0.065	0.300	0.822	.210 - .265	1/4	41728	025-30998-000
Straight	14 - 10	0.065	0.300	0.775	.225 - .275	1/4	60635-1	025-17076-000
Flag	18 - 12	0.124	0.318	.670 Max.	.110 - .210	7/32	41802	025-06759-000
Flag	12 - 10	0.124	0.318	.670 Max.	.110 - .210	7/32	42563-8	025-13812-000
Straight**	18 - 14	0.115	0.300	0.770	.120 - .170	7/32	61944-2	025-11190-000
Straight**	14 - 10	0.105	0.300	0.770	.150 - .200	7/32	62253-2	025-19990-000

\* = Wire insulation O.D. is given for those terminals having insulation support

\*\* = Terminal called a "Piggy-Back", having a male-tab on back side to receive an extra female terminal

\*\*\* = When wire insulation diameter exceeds listed range for terminal, use terminal 025-14291-000; Also see Application, Paragraph 7.4(e)

All dimensions are for reference purposes only.

Primary dimensions ( ) are American standard inches, metric millimeter dimensions are in brackets [ ]

**PART NUMBER FOR GLOBALLY DESIGNED UNITS**

YORK INTERNATIONAL CORPORATION	ENGINEERED SYSTEMS (ESG) ENGINEERING STANDARD  TERMINALS-WIRE FOR ELECTRICAL CONDUCTORS AND TERMINAL HOUSINGS	STANDARD NO.	C-51
		PAGE	13 OF 41
		DATE	03-28-04
		SUPERSEDES	07-10-03
		ECN	0703-3026
		PREPARED BY	L.N. Fair
APPROVED BY	B.A. Smith		

TABLE 3.7(d)

AMP Faston Series 250 Terminals - ESG Non-Standard Type

FITS .250" x .032" MALE TAB									
Type	Wire Size AWG No.	Terminal Dimensions (in.)				Recom. Wire Strip Length	Part Number		Remarks
		Width Inside "T"	Width Outside "W"	Length Overall "L"	Wire Insulation (O.D.) * "D"		AMP	York	
Straight	18 - 16	0.065	0.301	.805 Max.	.120 - .170	1/4	41729	025-08188-000	Loose Piece
Straight	18 - 14	0.115	0.300	0.780	.150 - .210	1/4	42692-2	025-25920-000	
Straight	14 - 10	0.124	0.318	0.770	.150 - .200	1/4	42437-2	025-09455-000	

All dimensions are for reference purposes only.  
Primary dimensions ( ) are American standard inches, metric millimeter dimensions are in brackets [ ]

**BOLD PART NUMBER FOR GLOBALLY DESIGNED UNITS**

TABLE 3.7(e)

AMP Faston Series 187 Terminals

FITS .187" x .032" MALE TAB									
Type	Wire Size AWG No.	Terminal Dimensions (in.)				Recom. Wire Strip Length	Part Number		Remarks
		Width Inside "T"	Width Outside "W"	Length Overall "L"	Wire* Insulation (O.D.) * "D"		AMP	York	
Straight	20 - 16	0.040	0.221	0.470	-----	5/32	42373-2	025-08188-000	
Straight	20 - 16	0.040	0.221	0.470	-----	5/32	42638-2	025-25920-000	Loose Piece
Straight	18 - 14	0.030	0.225	0.640	.180 - .230	7/32	60742-2	025-09455-000	
Flag	18 - 14	0.060	0.230	0.430	.060 - .150	3/16	63512-1	025-37821-000	

\* = Wire insulation O.D. is given for those terminals having insulation support

All dimensions are for reference purposes only.  
Primary dimensions ( ) are American standard inches, metric millimeter dimensions are in brackets [ ]

**BOLD PART NUMBER FOR GLOBALLY DESIGNED UNITS**

YORK INTERNATIONAL CORPORATION	ENGINEERED SYSTEMS (ESG) ENGINEERING STANDARD	STANDARD NO.	C-51
	TERMINALS-WIRE FOR ELECTRICAL CONDUCTORS AND TERMINAL HOUSINGS	PAGE	14 OF 41
		DATE	03-28-04
		SUPERSEDES	07-10-03
		ECN	0703-3026
		PREPARED BY	L.N. Fair
	APPROVED BY	B.A. Smith	

TABLE 3.7(f)

AMP Faston Insulated Series Terminals

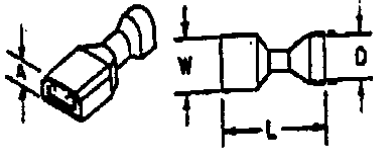

Straight

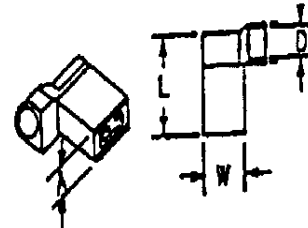

Flag

FITS .250" x .032" MALE TAB										
Type	Wire Size AWG No.	Terminal Dimensions (in.)				Recom. Wire Strip Length (1) Wire	Recom.* Wire Strip Length (2) Wires	Part Number		
		Thk. "A"	Width "W"	Length "L"	Wire* Insulation (O.D.) * Max. "D"			AMP	MOLEX	York
Straight	22 - 18	0.195	0.370	0.855	.135	9/32	5/16	2-520183-2	----	025-21156-000
Straight	16 - 14	0.195	0.370	0.935	.260	9/32	5/16	3-520140-2	----	025-23735-000
Straight	16- 14	0.195	0.409	.935	.160	9/32	5/16	3-350820-2	----	025-35940-000
Flag	22 - 18	0.187	0.385	0.636	.165	5/16	.335	2-520128-2	----	025-21771-000
Flag	16 - 14	0.187	0.385	0.632	.185	5/16	.335	3-520132-2	----	025-23736-000
Flag	12-10	0.196	---	.667	.320	9/32	5/16	----	C-2211	025-35976-000
Straight	12 - 10	0.250	0.373	0.935	0.320	5/16	5/16	4-520447-2	----	025-30996-000

\* = Combination wire sizes may not exceed circular mil area of largest wire terminal will receive  
See reel/carbon labels for correct qtys.  
105 degree Max. operating temperature  
All dimensions are for reference purposes only.  
Primary dimensions ( ) are American standard inches, metric millimeter dimensions  
**BOLD PART NUMBER FOR GLOBALLY DESIGNED UNITS**

FITS .187" x .020" MALE TAB										
Type	Wire Size AWG No.	Terminal Dimensions (in.)				Recom. Wire Strip Length (1) Wire	Recom.* Wire Strip Length (2) Wires	Part Number		
		Thk. "A"	Width "W"	Length "L"	Wire* Insulation (O.D.) * Max. "D"			AMP	York	
Straight	22 - 18	0.165	0.300	0.855	.135	9/32	5/16	2-520181-2		025-23737-000
Straight	16 - 14	0.185	0.300	0.935	.260	9/32	5/16	3-520150-2		025-23738-000
Flag	22 - 18	0.187	0.320	0.636	.165	9/32	5/16	2-520334-2		025-33774-000
Flag	16 - 14	0.187	0.320	0.632	.165	9/32	5/16	3-520338-2		025-33775-000

\* = Combination wire sizes may not exceed circular mil area of largest wire terminal will receive  
See reel/carbon labels for correct qtys.  
105 degree Max. operating temperature  
All dimensions are for reference purposes only.  
Primary dimensions ( ) are American standard inches, metric millimeter dimensions  
**BOLD PART NUMBER FOR GLOBALLY DESIGNED UNITS**

YORK INTERNATIONAL CORPORATION	ENGINEERED SYSTEMS (ESG) ENGINEERING STANDARD  TERMINALS-WIRE FOR ELECTRICAL CONDUCTORS AND TERMINAL HOUSINGS	STANDARD NO.	C-51
		PAGE	15 OF 41
		DATE	03-28-04
		SUPERSEDES	07-10-03
		ECN	0703-3026
		APPROVED BY	B.A. Smith

TABLE 3.7(f) (Cont'd.)

AMP Faston Insulated Series Terminals

FITS .110/125" x .020" MALE TAB									
Type	Wire Size AWG No.	Terminal Dimensions (in.)				Recom. Wire Strip Length (1) Wire	Recom.* Wire Strip Length (2) Wires	Part Number	
		Thk. "A"	Width "W"	Length "L"	Wire* Insulation (O.D.) * Max. "D"			AMP	York
Straight	22 - 18	0.081	0.148	0.734	.100	9/32	N/A	60894-1	025-35935-000
Straight	22 - 18	0.160	0.239	0.735	.120	9/32	5/16	2-520083-2	025-32507-000
Straight	16 - 14	0.175	0.239	0.865	.260	9/32	5/16	3-520370-2	025-32840-000

\* = Combination wire sizes may not exceed circular mil area of largest wire terminal will receive  
See reel/carbon labels for correct qtys.  
105 degree Max. operating temperature  
All dimensions are for reference purposes only.  
Primary dimensions ( ) are American standard inches, metric millimeter dimensions are in brackets [ ]  
**BOLD PART NUMBER FOR GLOBALLY DESIGNED UNITS**

MALE TAB TYPE - FITS .250" x .032" FEMALE RECEPTACLE									
Type	Wire Size AWG No.	Terminal Dimensions (in.)				Recom. Wire Strip Length (1) Wire	Recom.* Wire Strip Length (2) Wires	Part Number	
		Thk. "A"	Width "W"	Length "L"	Wire* Insulation (O.D.) * Max. "D"			AMP	York
Straight	22 - 18	0.290	0.522	0.855	.135	9/32	5/16	2-520102-2	025-32932-000
Straight	16 - 14	0.290	0.522	0.855	.160	9/32	5/16	3-520106-2	025-31739-000

\* = Combination wire sizes may not exceed circular mil area of largest wire terminal will receive  
See reel/carbon labels for correct qtys.  
105 degree Max. operating temperature  
All dimensions are for reference purposes only.  
Primary dimensions ( ) are American standard inches, metric millimeter dimensions are in brackets [ ]  
**BOLD PART NUMBER FOR GLOBALLY DESIGNED UNITS**

YORK INTERNATIONAL CORPORATION	ENGINEERED SYSTEMS (ESG) ENGINEERING STANDARD  TERMINALS-WIRE FOR ELECTRICAL CONDUCTORS AND TERMINAL HOUSINGS	STANDARD NO.	C-51
		PAGE	16 OF 41
		DATE	03-28-04
		SUPERSEDES	07-10-03
		ECN	0703-3026
		APPROVED BY	B.A. Smith

(g) AMP Push-On Terminal Adapters are used to convert screw or rivet type terminals to Push-On Type, or to provide two connections when only one is available. General characteristics shall be as shown in Table 3.7(g).

TABLE 3.7(g)  
Push-On Terminal Adapters

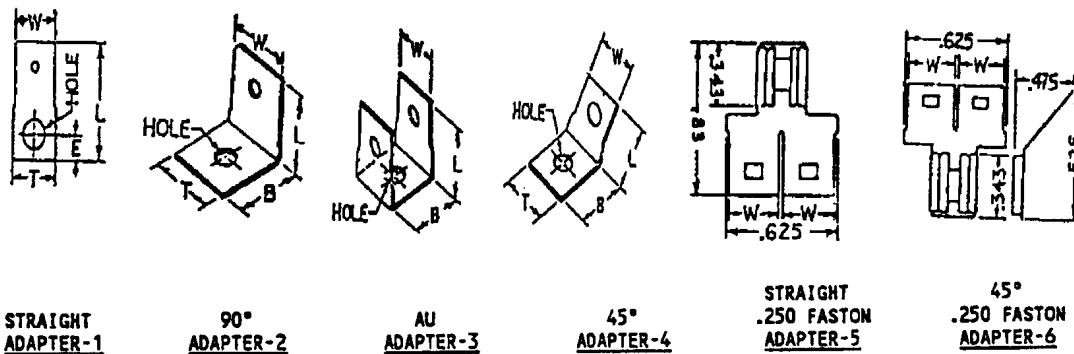

Push-On Adapter Terminals have .250" x .032" Tabs, Tin Plated Brass												
No. of Tabs or Receptables		General Type	Adapter No.	Dimensions					Part Numbers			
				Hole Dia.	"W"	"T"	"B"	"L"	"E"	Supplier	York	
Tab	Recept.											
2	1	Angle	6	-----	.250	-----	-----	-----	-----	Kent	121209	025-10295-000
2	1	Straight	5	-----	.250	-----	-----	-----	-----	AMP	61765-2	N/A
1	0	Straight	1	.177	.250	.295	-----	.715	.170	AMP	63038-2	N/A
1	0	Straight	1	.203	.250	.300	-----	.695	.141	Kent	121209	025-10437-000
1	0	Angle 90 degree	2	.171	.250	.295	.330	.440	-----	AMP	42214-2	025-10185-000
1	0	Angle 90 degree	2	.171	.250	.409	.425	.462	.216	Kulka Marco	KT81 QC3236	025-18650-000
1	0	Angle 45 degree	4	.171	.250	.295	.331	.375	-----	AMP	60465-1	N/A
1	0	Angle 45 degree	4	.203	.250	.295	.331	.375	-----	AMP	61365-1	025-10436-000
2	0	AU	3	.171	.250	.250	.390	.315	-----	AMP	42802-1	025-15579-000

All dimensions are for reference purposes only.

Primary dimensions ( ) are American standard inches, metric millimeter dimensions are in brackets [ ]

**BOLD PART NUMBER FOR GLOBALLY DESIGNED UNITS**

YORK INTERNATIONAL CORPORATION	ENGINEERED SYSTEMS (ESG) ENGINEERING STANDARD  TERMINALS-WIRE FOR ELECTRICAL CONDUCTORS AND TERMINAL HOUSINGS	STANDARD NO.	C-51
		PAGE	17 OF 41
		DATE	03-28-04
		SUPERSEDES	07-10-03
		ECN	0703-3026
		APPROVED BY	B.A. Smith

3.8 Terminal Wire Splices are used to join conductors inside electrical closures. Insulated butt splices are good for 600V applications. Insulated closed end splices are good for 300V applications. Uninsulated parallel splices have voltage application dependent on the applied insulation. Characteristics for insulated splices shall be as shown in Table 3.8(a), for uninsulated splices in Table 3.8(b).

TABLE 3.8(a)

Insulated Terminal Wire Splices

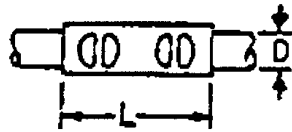

Butt Splice

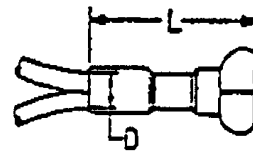

Closed End Splice

AMP Butt and closed End							
Wire Size AWG No,	Type	Insulation Color	Max. Length "L"	Wire Insulation (0.0, "0"	Recom. Wire Strip Length	Part Number	
						AMP	York
22 - 16	Butt	Red	1.016	.105 - .140	1/4	34070	025 10535-000
16 - 14	Butt	Blue	1.065	.115 - .170	1/4	34071	025 13889 000
22 - 16	Closed End	Blue	0.750	0.250	11/32	34349	025 11093-000
12 - 16	Closed End	Yellow	1.010	0.300	7/16	34865	025 11095-000

All dimensions are for reference purposes only.

Primary dimensions ( ) are American standard inches, metric millimeter dimensions are in brackets

**BOLD PART NUMBER FOR GLOBALLY DESIGNED UNITS**

YORK INTERNATIONAL CORPORATION	ENGINEERED SYSTEMS (ESG) ENGINEERING STANDARD  TERMINALS-WIRE FOR ELECTRICAL CONDUCTORS AND TERMINAL HOUSINGS	STANDARD NO.	C-51
		PAGE	18 OF 41
		DATE	03-28-04
		SUPERSEDES	07-10-03
		ECN	0703-3026
		APPROVED BY	B.A. Smith

TABLE 3.8(b)

Uninsulated Terminal Wire Splices

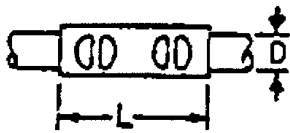

Butt Splice

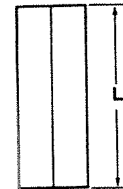

Parallel Splice

AMP Uninsulated Parallel Splices (Solistrand)					
Wire Size AWG No,	Type	Dim. "L"	Recom. Wire Strip Length	Part Number	
				AMP	York
22 - 16	Parallel	.301"		34130	
16 - 14	"	.301"	21/64	34137	025-37828-000
12 - 10	"	.343"		34138	

All dimensions are for reference purposes only.

Primary dimensions ( ) are American standard inches, metric millimeter dimensions are in brackets

**BOLD PART NUMBER FOR GLOBALLY DESIGNED UNITS**

AMP Uninsulated Butt Splice (Solistrand)							
Wire Size AWG No.	Type	Insulation Color	Length "L"	Wire Insulation (O.D.) "D"	Recom. Wire Strip Length	Part Number	
						AMP	York
16 -14	Butt	-----	1.016	-----	1/4	31819	025-31752-0000

All dimensions are for reference purposes only.

Primary dimensions ( ) are American standard inches, metric millimeter dimensions are in brackets

**BOLD PART NUMBER FOR GLOBALLY DESIGNED UNITS**

3.9 AMP Universal Mate-N-Lock housings and Universal Mate-N-Lock contacts are shown in Table 3.9(a) and Table 3.9(b) respectively.

YORK INTERNATIONAL CORPORATION	ENGINEERED SYSTEMS (ESG) ENGINEERING STANDARD	STANDARD NO.	C-51
	TERMINALS-WIRE FOR ELECTRICAL CONDUCTORS AND TERMINAL HOUSINGS	PAGE	19 OF 41
		DATE	03-28-04
		SUPERSEDES	07-10-03
		ECN	0703-3026
		PREPARED BY	L.N. Fair
		APPROVED BY	B.A. Smith

TABLE 3.9(a)

Universal MATE-N-LOK Housings

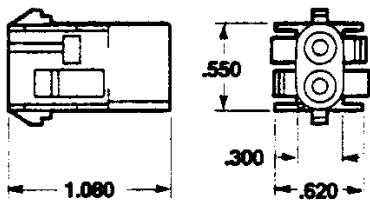

Cap

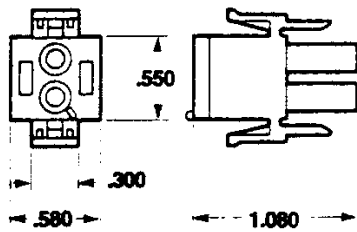

Plug

2 Circuit, In Line

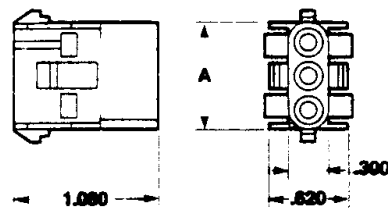

Cap

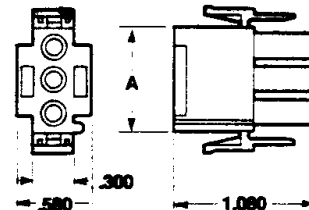

Plug

3, 4, 5, 6, 8 and 10 Circuit.  
In Line (3 Shown)

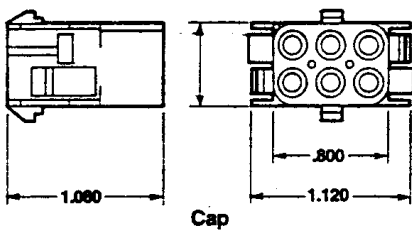

Cap

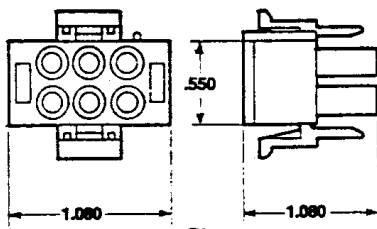

Plug

6 Circuit

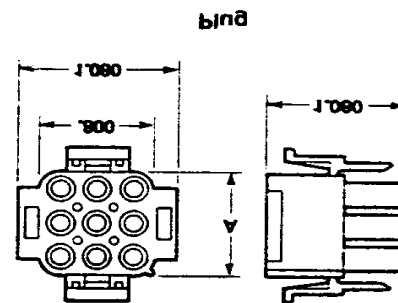

Cap

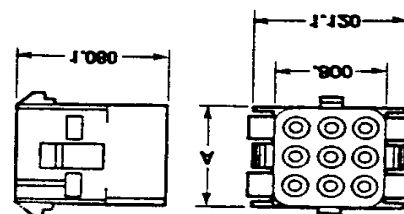

9, 12 and 15 Circuit (9 Shown)

YORK INTERNATIONAL CORPORATION	ENGINEERED SYSTEMS (ESG) <u>ENGINEERING STANDARD</u>  TERMINALS-WIRE FOR ELECTRICAL CONDUCTORS AND TERMINAL HOUSINGS	STANDARD NO.	C-51
		PAGE	20 OF 41
		DATE	03-28-04
		SUPERSEDES	07-10-03
		ECN	0703-3026
		PREPARED BY	L.N. Fair
		APPROVED BY	B.A. Smith

TABLE 3.9(a) (Cont'd.)

Number of Circuits	Dim. "A"	Housing - Plug*		Housing - Cap*	
		Part Number		Part Number	
		AMP	York	AMP	York
2 (In-Line)	-----	1-480698-0	025-19672-000	1-480699-0	025-21159-000
3 (In-Line)	0.800	1-480700-0	025-19671-000	1-480701-0	025-21193-000
4 (In-Line)	1.050	1-480702-0	025-21417-000	1-480703-0	025-21756-000
5 (In-Line)	1.300	1-480763-0	N/A	1-480764-0	N/A
6	-----	1-480704-0	025-19670-000	1-480705-0	025-20963-000
6 (In-Line)	-----	640585-1	025-32566-000	926307-1	025-35141-000
8 (In-Line)	2.050	640586-1	025-28388-000	926308-1	N/A
9	0.800	1-480706-0	025-21192-000	1-480707-0	025-21191-000
10 (In-Line)	2.550	926302-1	N/A	926309-1	N/A
12	1.050	1-480708-0	025-21196-000	1-480709-0	025-20787-000
15	1.300	1-480710-0	025-20918-000	1-480711-0	025-20788-000

\* = Material (Nylon 94V-2 Natural Color)

All dimensions are for reference purposes only.  
Primary dimensions ( ) are American standard inches,  
metric millimeter dimensions are in brackets [ ]

**BOLD PART NUMBER FOR GLOBALLY DESIGNED UNITS**

YORK INTERNATIONAL CORPORATION	ENGINEERED SYSTEMS (ESG) ENGINEERING STANDARD  TERMINALS-WIRE FOR ELECTRICAL CONDUCTORS AND TERMINAL HOUSINGS	STANDARD NO.	C-51
		PAGE	21 OF 41
		DATE	03-28-04
		SUPERSEDES	07-10-03
		ECN	0703-3026
		PREPARED BY	L.N. Fair
		APPROVED BY	B.A. Smith

TABLE 3.9(b)

Universal MATE-N-LOK Contacts

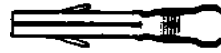
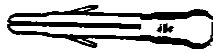

Pin

Socket

Type (1)	Wire Size	Wire Insulation O.D.	Recom. Wire Strip Length	Part Number	
				AMP	York
Pin	20-14	.130 - .200	11/64	350538-1	025-20533-000
Socket	20-14	.130 - .200	11/64	350537-1	025-19673-000
Socket	20-14	.060 - .130	11/64	350550-3	025-27232-000 **
Pin	12-10	.200 max. *	11/64	350922-3	025-20990-000 **
Socket	12-10	.200 max. *	11/64	350923-3	025-20991-000 **
Pin +	20-14	.130 - .200	11/64	350700-1	025-20919-000
Pin +	20-14	.060 - .130	11/64	350687-1	025-22214-000
Socket	20-14	.060 - .130	11/64	350536-1	025-22215-000

\* - This contact has no insulation barrel, insulation maximum O.D. is limited by housing.  
\*\* - Contact is pre-tin plate phosphor bronze.  
(1) - Pin and socket contacts can be used in either plug or cap universal MATE-N-LOK housings of Table 3.9(a).  
All dimensions are for reference purposes only.  
Primary dimensions ( ) are American standard inches, metric millimeter dimensions are in brackets [ ]  
**BOLD PART NUMBER FOR GLOBALLY DESIGNED UNITS**

3.10 AMP Commercial MATE-N-LOK housings and Commercial MATE-N-LOK contacts are shown in table 3.10(a) and 3.10(b), respectively.

YORK INTERNATIONAL CORPORATION	ENGINEERED SYSTEMS (ESG) ENGINEERING STANDARD  TERMINALS-WIRE FOR ELECTRICAL CONDUCTORS AND TERMINAL HOUSINGS	STANDARD NO.	C-51
		PAGE	22 OF 41
		DATE	03-28-04
		SUPERSEDES	07-10-03
		ECN	0703-3026
		PREPARED BY	L.N. Fair
		APPROVED BY	B.A. Smith

TABLE 3.10 (a)

Commercial MATE-N-LOK Housings

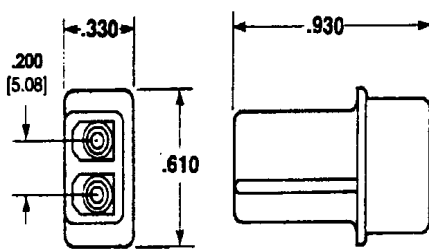

2 Circuit In-Line  
Pin Housing

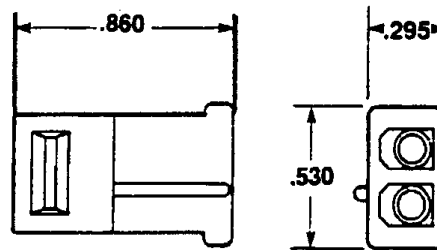

2 Circuit In-Line  
Socket Housing

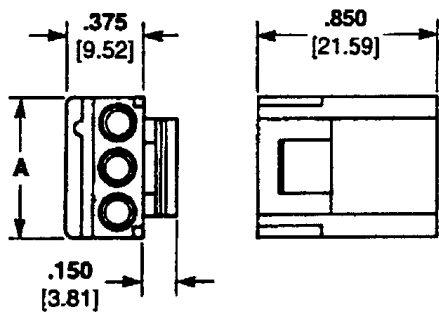

2, 3 and 4 Circuit, Positive Lock  
Socket Housing (3 Shown)

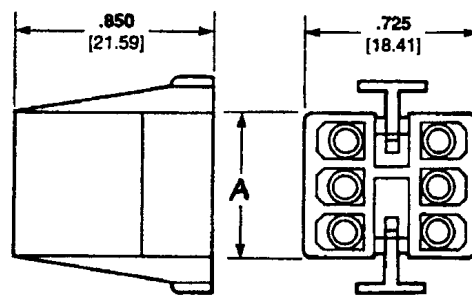

6, 8, 10, 12 and 16 Circuit  
Socket Housing (6 Shown)

YORK INTERNATIONAL CORPORATION	ENGINEERED SYSTEMS (ESG) <u>ENGINEERING STANDARD</u>  TERMINALS-WIRE FOR ELECTRICAL CONDUCTORS AND TERMINAL HOUSINGS	STANDARD NO.	C-51
		PAGE	23 OF 41
		DATE	03-28-04
		SUPERSEDES	07-10-03
		ECN	0703-3026
		APPROVED BY	B.A. Smith

TABLE 3.10 (a) (Cont'd.)

Number Of Circuits	Socket - Housing			Pin - Housing		
	Dim. "A"	Part Number		Dim. "A"	Part Number	
		AMP	York		AMP	York
2 (In-Line)	.530	1-480318-0**	025-19667-000	.610	1-480319-0	025-27974-000
2	.435	1-480720-0	025-21136-000			
2	.435	1-480720-2**	025-27975-000			
3	.630	1-480721-0	025-21137-000			
3	.825	1-480303-0	025-37879-000	.810	1-480305-0	025-34541-000
4	.830	1-480722-0	025-21138-000			
6	.610	1-480270-0	025-19668-000			
8	.805	1-480283-0	025-20972-000			
10	1.000	1-480285-0	025-19514-000			
12	1.195	1-480287-0	025-18955-000			
16	1.585	1-480438-0	025-21139-000			

\* = Material (Nylon 94V-2 Natural Color)

\*\* = Color Red (If not available order 025-21136-000 and dye red per E-155)

All dimensions are for reference purposes only.

Primary dimensions ( ) are American standard inches, metric millimeter dimensions are in brackets [ ]

**BOLD PART NUMBER FOR GLOBALLY DESIGNED UNITS**

TABLE 3.10 (b)  
Commercial MATE-N-LOK Contacts

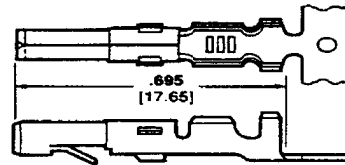
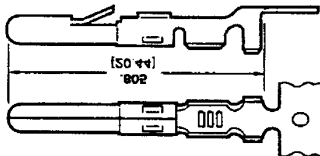

Type	Wire Size	Wire Insulation O.D.	Recom. Wire Strip Length	Part Number		
				AMP		York
				Loose	Reel	
Pin	20 - 14	.130 max.	5/32	61118-1	-----	025-18443-000
Socket	20 - 14	.130 max.	5/32	61117-1	-----	025-19674-000
Socket	(2) 18	.115 max.	5/32	350557-1	-----	025-32506-000
Socket	24 - 18	.130 max.	5/32	60617-1	61314-4	025-33701-000

All dimensions are for reference purposes only.

Primary dimensions ( ) are American standard inches, metric millimeter dimensions are in bracket:

**BOLD PART NUMBER FOR GLOBALLY DESIGNED UNITS**

YORK INTERNATIONAL CORPORATION	ENGINEERED SYSTEMS (ESG) ENGINEERING STANDARD  TERMINALS-WIRE FOR ELECTRICAL CONDUCTORS AND TERMINAL HOUSINGS	STANDARD NO.	C-51
		PAGE	24 OF 41
		DATE	03-28-04
		SUPERSEDES	07-10-03
		ECN	0703-3026
		APPROVED BY	B.A. Smith

3.11 AMP Min-Universal MATE-N-LOK housings (plugs) and Mini-Universal MATE-N-LOK contacts (sockets) are shown in Table 3.11(a) and 3.11(b), respectively.

TABLE 3.11(a)

**2 and 3 Circuit,  
In-Line**

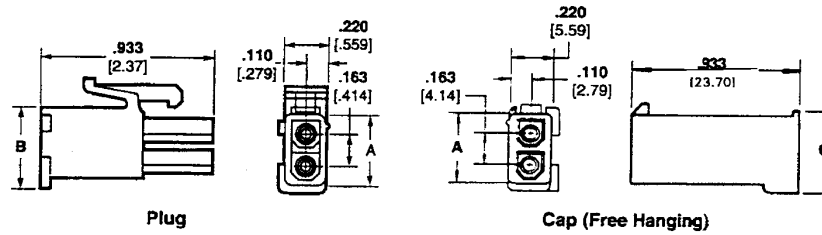

**4 and 6 Circuit, Dual Row**

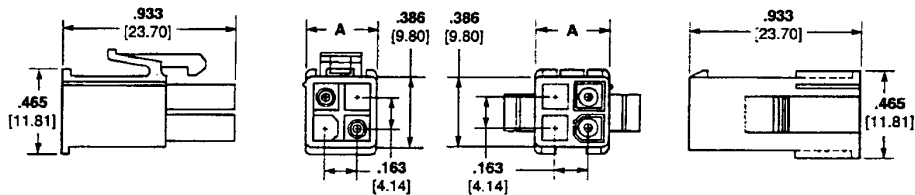

**9, 12 and 15 Circuit,  
Free Hanging**

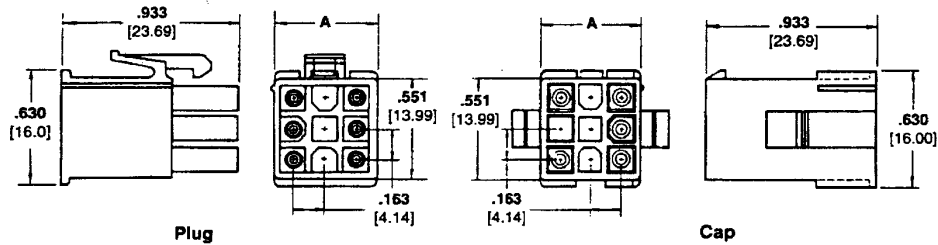

**16 thru 24 Circuit,  
Free Hanging, Dual Row**

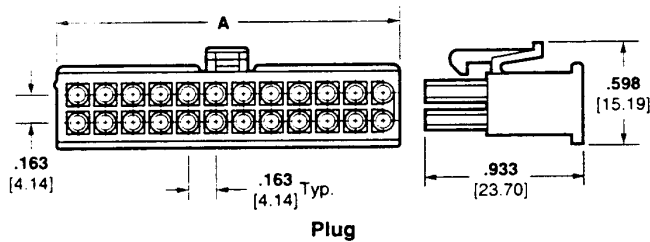

YORK INTERNATIONAL CORPORATION	ENGINEERED SYSTEMS (ESG) <u>ENGINEERING STANDARD</u>  TERMINALS-WIRE FOR ELECTRICAL CONDUCTORS AND TERMINAL HOUSINGS	STANDARD NO.	C-51
		PAGE	25 OF 41
		DATE	03-28-04
		SUPERSEDES	07-10-03
		ECN	0703-3026
		PREPARED BY	L.N. Fair
		APPROVED BY	B.A. Smith

TABLE 3.11 (a) (Cont'd.)

Number of Circuits	Dim. "A"	Dim. "B"	Dim. "C"	Housing - Plug*		Housing - Cap*	
				Part Number		Part Number	
				AMP	York	AMP	York
2	.386	.425	.488	172165-1	025-29130-000	172233-1	025-32564-000
3	.551	.591	.654	172166-1	025-29185-000	172234-1	N/A
4	.386	-----	-----	172167-1	025-28959-000	172159-1	025-32962-000
6	.551	-----	-----	172168-1	025-28382-000	172160-1	025-32960-000
9	.551	-----	-----	172169-1	025-28383-000	172161-1	025-34537-000
12	.716	-----	-----	172170-1	025-28384-000	172162-1	025-34147-000
15	.882	-----	-----	172171-1	025-28385-000	172163-1	025-34539-000
16	1.366	-----	-----	770583-1	025-34143-000	N/A	N/A
18	1.529	-----	-----	770584-1	025-35964-000	N/A	N/A
20	1.692	-----	-----	770585-1	025-34116-000	N/A	N/A
22	1.855	-----	-----	770586-1	025-34117-000	N/A	N/A
24	2.018	-----	-----	770587-1	025-34533-000	N/A	N/A

\* = Material (Nylon 94V-0 White Color)

All dimensions are for reference purposes only.  
Primary dimensions ( ) are American standard inches.  
Metric millimeter dimensions are in brackets [ ].  
**BOLD PART NUMBER FOR GLOBALLY DESIGNED UNITS**

TABLE 3.11 (b)

Mini-Universal MATE-N-LOK Contacts

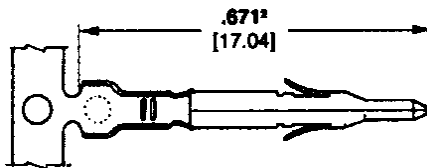

Pin

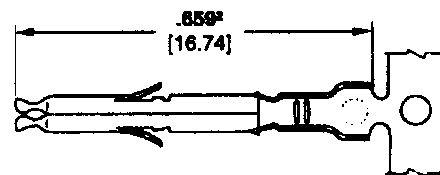

Socket

Contact	Wire Size	Wire Insulation O.D.	Recom. Wire Strip Length	Part Number	
				Amp	York
Socket	22 - 18	.060 - .135	1/8	770904-1	025-28686-000
Pin	22 -18	.060 - .135	1/8	770903-1	025-30999-000
Socket, Gold	20 x (2)	.094 x (2)	5/32	171637-3	025-39579-000
Socket, Tin	20 x (2)	.094 x (2)	5/32	171637-1	025-37830-000

All dimensions are for reference purposes only.  
Primary dimensions ( ) are American standard inches,  
Metric millimeter dimensions are in brackets  
**BOLD PART NUMBER FOR GLOBALLY DESIGNED UNITS**

YORK INTERNATIONAL CORPORATION	ENGINEERED SYSTEMS (ESG) ENGINEERING STANDARD	STANDARD NO. C-51
	TERMINALS-WIRE FOR ELECTRICAL CONDUCTORS AND TERMINAL HOUSINGS	PAGE 26 OF 41
		DATE 03-28-04
		SUPERSEDES 07-10-03
		ECN 0703-3026
		PREPARED BY L.N. Fair
APPROVED BY B.A. Smith		

3.12 AMP Min-Universal MATE-N-LOK 2 housings (plugs) and Mini-Universal MATE-N-LOK 2 contacts (sockets) are shown in Table 3.12(a) and 3.12(b), respectively.

TABLE 3.12(a)

**2 AND 3 CIRCUIT, IN-LINE**

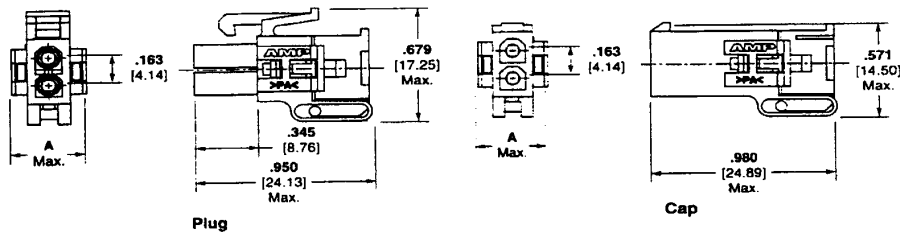

**4 AND 6 CIRCUIT, DUAL ROW**

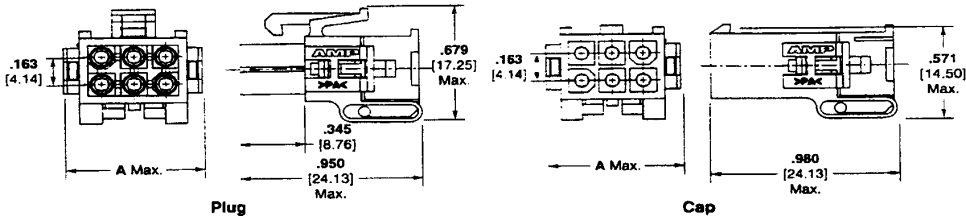

**9, 12 AND 15 CIRCUIT, MATRIX**

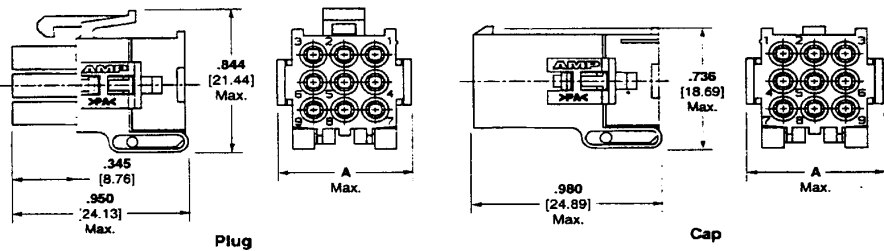

**8 and 16 thru 24 Circuit  
(Dual Row)**

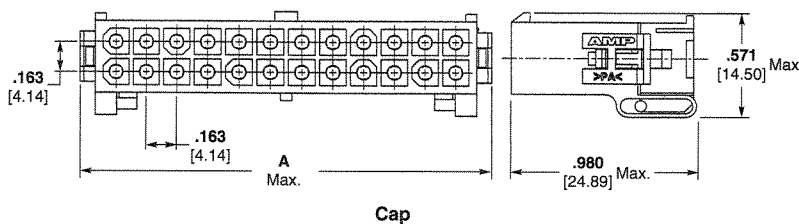

YORK INTERNATIONAL CORPORATION	ENGINEERED SYSTEMS (ESG) ENGINEERING STANDARD  TERMINALS-WIRE FOR ELECTRICAL CONDUCTORS AND TERMINAL HOUSINGS	STANDARD NO.	C-51
		PAGE	27 OF 41
		DATE	03-28-04
		SUPERSEDES	07-10-03
		ECN	0703-3026
		APPROVED BY	B.A. Smith

TABLE 3.12 (a) (Cont'd.)

Number of Circuits	Dim. "A"	Dim. "B"	Dim. "C"	Housing - Plug*		Housing - Cap*	
				Part Number		Part Number	
				AMP	York	AMP	York
2	.405	.679	.571	794184-1	N/A	794185-1	N/A
3	.405	.844	.736	794186-1	N/A	794187-1	N/A
4	.571	-----	-----	794188-1	N/A	794189-1	N/A
6	.736	-----	-----	794190-1	N/A	794191-1	N/A
8	.899	-----	-----	794192-1	025-34144-000	794193-1	025-34557-000
9	.736	-----	-----	794194-1	N/A	794195-1	N/A
12	.901	-----	-----	794200-1	N/A	794201-1	N/A
15	1.067	-----	-----	794204-1	N/A	794205-1	N/A
16	1.551	-----	-----	794206-1	N/A	794207-1	025-37880-000
18	1.714	-----	-----	794208-1	N/A	794209-1	N/A
20	1.877	-----	-----	794210-1	N/A	794211-1	N/A
22	2.040	-----	-----	794212-1	N/A	794213-1	N/A
24	2.203	-----	-----	794214-1	N/A	794215-1	N/A

\* = Material (Nylon 94V-0 White Color)

All dimensions are for reference purposes only.  
Primary dimensions ( ) are American standard inches.  
Metric millimeter dimensions are in brackets [ ].

**BOLD PART NUMBER FOR GLOBALLY DESIGNED UNITS**

TABLE 3.12 (b)

Mini-Universal MATE-N-LOK 2 Sockets

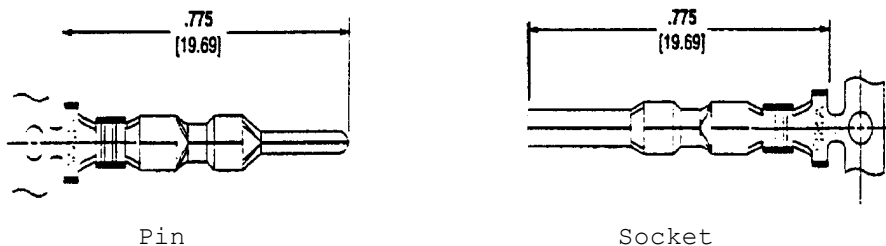

Contact	Wire Size	Wire Insulation O.D.	Recom. Wire Strip Length	Part Number	
				AMP	York
Socket	20 - 16	.079 - .126	1/8	794223-1	025-34145-000
Pin	20 - 16	.079 - .126	1/8	794222-1	025-34563-000

All dimensions are for reference purposes only.  
Primary dimensions ( ) are American standard inches,  
Metric millimeter dimensions are in brackets [ ]

**BOLD PART NUMBER FOR GLOBALLY DESIGNED UNITS**

YORK INTERNATIONAL CORPORATION	ENGINEERED SYSTEMS (ESG) ENGINEERING STANDARD  TERMINALS-WIRE FOR ELECTRICAL CONDUCTORS AND TERMINAL HOUSINGS	STANDARD NO.	C-51
		PAGE	28 OF 41
		DATE	03-28-04
		SUPERSEDES	07-10-03
		ECN	0703-3026
		APPROVED BY	B.A. Smith

3.13 AMP Micro MATE-N-LOK housings and Micro MATE-N-LOK contacts are shown in Table 3.13(a) and 3.13(b), respectively.

TABLE 3.13(a)

2 thru 24 CIRCUIT RECEPTACLE HOUSING DUAL ROW

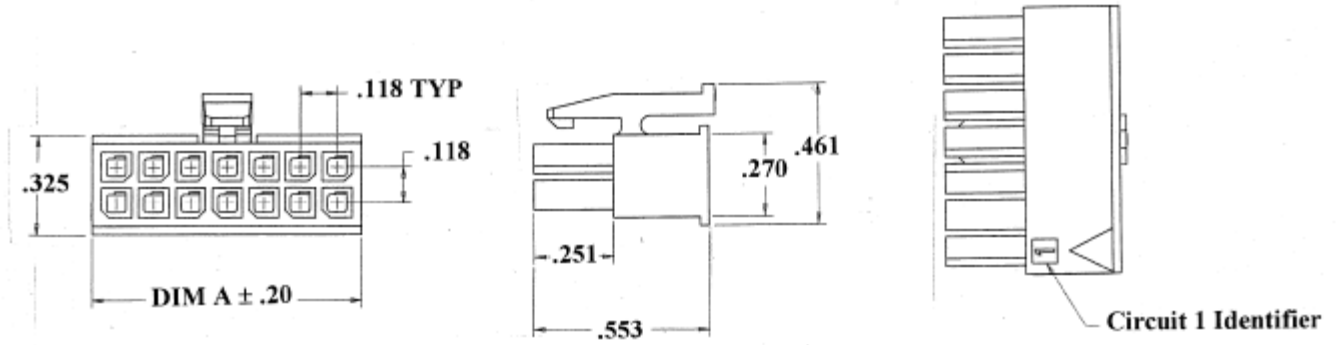

2 thru 24 CIRCUIT PLUG HOUSING DUAL ROW

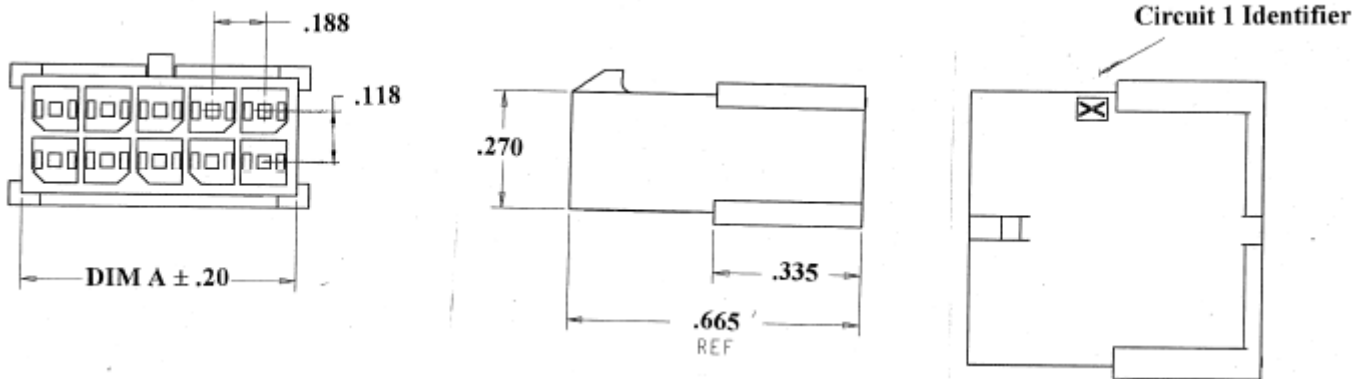

YORK INTERNATIONAL CORPORATION	ENGINEERED SYSTEMS (ESG) ENGINEERING STANDARD  TERMINALS-WIRE FOR ELECTRICAL CONDUCTORS AND TERMINAL HOUSINGS	STANDARD NO.	C-51
		PAGE	29 OF 41
		DATE	03-28-04
		SUPERSEDES	07-10-03
		ECN	0703-3026
		PREPARED BY	L.N. Fair
		APPROVED BY	B.A. Smith

TABLE 3.13(a) (Cont'd)

Number Of Circuits	Dim "A"	Housing – Receptacle*		Dim "A"	Housing – Plug*	
		Part number			Part number	
		AMP	YORK		AMP	YORK
2	0.157	794617-2		0.157	794616-2	
4	0.276	794617-4		0.276	794616-4	
6	0.394	794617-6		0.94	794616-6	
8	0.512	794617-8	025-39326-000	0.512	794616-8	025-39334-000
10	0.63	1-794617-0		0.63	1-794616-0	
12	0.748	1-794617-2	025-39327-000	0.748	1-794616-2	025-39335-000
14	0.866	1-794617-4	025-39328-000	0.866	1-794616-4	025-39336-000
16	0.984	1-794617-6		0.984	1-794616-6	
18	1.102	1-794617-8		1.102	1-794616-8	
20	1.22	2-794617-0		1.22	2-794616-0	
22	1.339	2-794617-2		1.339	2-794616-2	
24	1.457	2-794617-4		1.457	2-794616-4	
* = Material (Nylon 94V-0 Black Color)						
All dimensions are for reference purposes only.						
Dimensions are American standard inches.						

TABLE 3.13 (b)

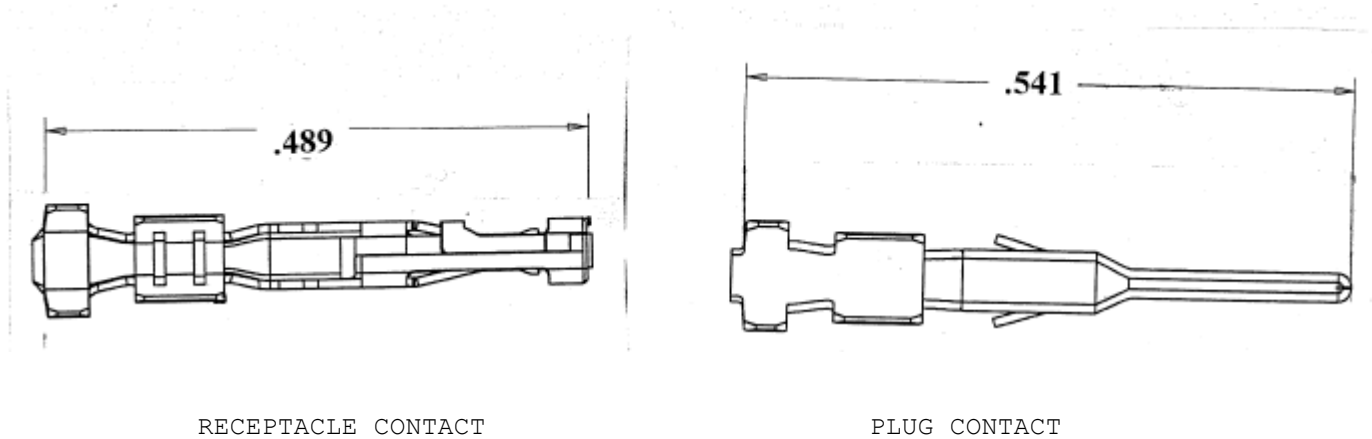

YORK INTERNATIONAL CORPORATION	ENGINEERED SYSTEMS (ESG) ENGINEERING STANDARD  TERMINALS-WIRE FOR ELECTRICAL CONDUCTORS AND TERMINAL HOUSINGS	STANDARD NO.	C-51
		PAGE	30 OF 41
		DATE	03-28-04
		SUPERSEDES	07-10-03
		ECN	0703-3026
		PREPARED BY	L.N. Fair
		APPROVED BY	B.A. Smith

Table 3.13 (b) (Cont'd)

Contact	Wire Size	Wire Insulation O.D.	Recom. Wire Strip Length	Part Number	
				Amp	York
Receptacle	20-24	.035 - .06	1/8	794606-1	025-39329-000
Plug	20-24	.035 - .06	1/8	794608-1	025-39333-000

3.14 Single Leaf .156 wire to board receptacle housings and contacts are shown in Table 3.14(a) and Table 3.14(b), respectively.

TABLE 3.14(a)

Housing with Locking RAMP  
1 thru 24 Positions (3 Shown)

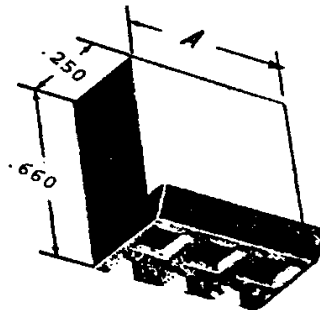

Number of Positions	Dim. "A"	Housing - Cap*	
		Part Number	
		AMP	York
5	.778	640250-5	025-34503-000
6	.933	640250-6	025-25158-000
13	2.022	1-640250-3	025-34504-000

\* = Material (Thermoplastic, 94V-0)

All dimensions are for reference purposes only.  
Primary dimensions ( ) are American standard inches,  
metric millimeter dimensions are in brackets [ ]

**BOLD PART NUMBER FOR GLOBALLY  
DESIGNED UNITS**

YORK INTERNATIONAL CORPORATION	ENGINEERED SYSTEMS (ESG) ENGINEERING STANDARD  TERMINALS-WIRE FOR ELECTRICAL CONDUCTORS AND TERMINAL HOUSINGS	STANDARD NO.	C-51
		PAGE	31 OF 41
		DATE	03-28-04
		SUPERSEDES	07-10-03
		ECN	0703-3026
		APPROVED BY	B.A. Smith

TABLE 3.14 (b)

Contacts - High Force

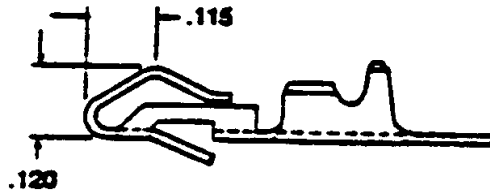

Wire Size	Wire Insulation O.D.	Recom. Wire Strip Length	Part Number	
			AMP	York
24 - 18	.043 - .110	5/32	640252-2	025-25157-000

All dimensions are for reference purposes only.  
 Primary dimensions ( ) are American standard inches,  
 metric millimeter dimensions are in brackets [ ]

**BOLD PART NUMBER FOR GLOBALLY DESIGNED UNITS**

YORK INTERNATIONAL CORPORATION	ENGINEERED SYSTEMS (ESG) ENGINEERING STANDARD  TERMINALS-WIRE FOR ELECTRICAL CONDUCTORS AND TERMINAL HOUSINGS	STANDARD NO.	C-51
		PAGE	32 OF 41
		DATE	03-28-04
		SUPERSEDES	07-10-03
		ECN	0703-3026
		APPROVED BY	B.A. Smith

3.15 MTA-156 IDC Connector-Closed End for 18 AWG wire are shown in Table 3.15.

TABLE 3.15

Closed End with Locking RAMP  
1 thru 24 Positions, 18 AWG

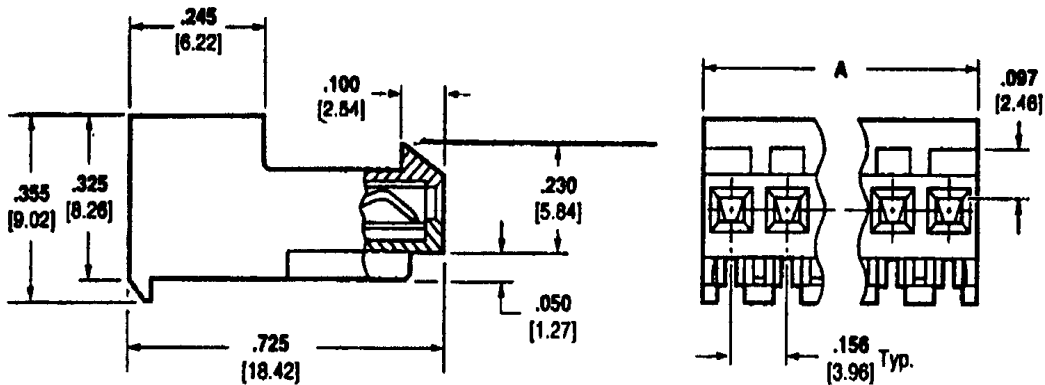

Number of Positions	Dim. "A"	Housing - Cap*	
		Part Number	
		AMP	York
5	.778	640426-5	025-33776-000
13	2.022	1-640426-3	025-33708-000

\* = Material (Thermoplastic, 94V-2)

All dimensions are for reference purposes only.  
Primary dimensions ( ) are American standard inches,  
metric millimeter dimensions are in brackets [ ]

**BOLD PART NUMBER FOR GLOBALLY  
DESIGNED UNITS**

YORK INTERNATIONAL CORPORATION	ENGINEERED SYSTEMS (ESG) ENGINEERING STANDARD  TERMINALS-WIRE FOR ELECTRICAL CONDUCTORS AND TERMINAL HOUSINGS	STANDARD NO.	C-51
		PAGE	33 OF 41
		DATE	03-28-04
		SUPERSEDES	07-10-03
		ECN	0703-3026
		PREPARED BY	L.N. Fair
		APPROVED BY	B.A. Smith

3.16 AMP Econoseal J Series waterproof Mark II housings and contacts are shown in Table 3.16(a) and Table 3.16(b), respectively.

TABLE 3.16(a)

Mark II Housings 2 and 3  
Positions, In-Line (2 Shown)

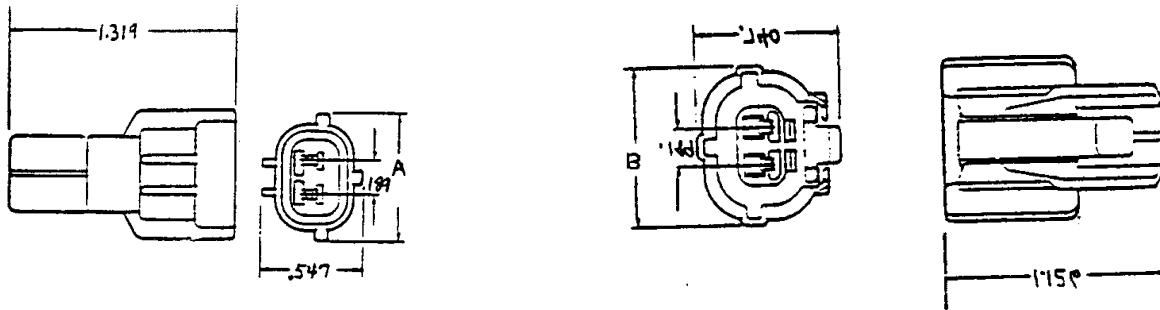

Cap (Tab) Housing

Plug (Receptacle) Housing Assembly

Number of Positions	Housing - Cap*			Housing - Plug*		
	Dim. "A"	Part Number		Dim. "B"	Part Number	
		AMP	York		AMP**	York
2	.720	173063-2	025-28948-000	.811	173090-2	025-28951-000
3	.909	173065-2	025-28953-000	1.000	173091-2	025-28954-000

\* = Material (PBT Black)

\*\* = Includes preassembled seal ring

All dimensions are for reference purposes only.

Primary dimensions ( ) are American standard inches, metric millimeter dimensions are in brackets [ ]

**BOLD PART NUMBER FOR GLOBALLY DESIGNED UNITS**

YORK INTERNATIONAL CORPORATION	ENGINEERED SYSTEMS (ESG) ENGINEERING STANDARD  TERMINALS-WIRE FOR ELECTRICAL CONDUCTORS AND TERMINAL HOUSINGS	STANDARD NO.	C-51
		PAGE	34 OF 41
		DATE	03-28-04
		SUPERSEDES	07-10-03
		ECN	0703-3026
		APPROVED BY	B.A. Smith

TABLE 3.16(b)

Mark II 070 Series Contacts and Rubber Collars

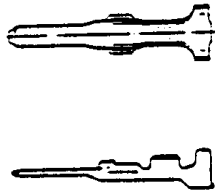

Tab \*

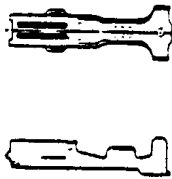

Receptacle \*

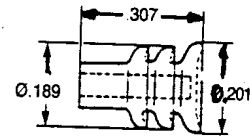

Rubber Collar \*\*

Wire Size	Wire Insulation O.D.	Type	Part Number		Recom. Wire Strip Length
			AMP	York	
24 - 20	.055 - .094	Tab	173600-1	N/A	.157 - .177
		Receptacle	171699-1	N/A	.157 - .177
		Rubber Collar (Black)	172746-1	025-28950-000	N/A
20 - 16	.079 - .102	Tab	173706-1	025-28949-000	.157 - .177
		Receptacle	173707-1	025-28952-000	.157 - .177
		Rubber Collar (Grey)	172888-2	025-28957-000	N/A

\* = Tab contact is for use in cap housing and receptacle contact is for use in plug housing

\*\* = Rubber collar is crimped with insulation support of contact

All dimensions are for reference purposes only.

Primary dimensions ( ) are American standard inches, metric millimeter dimensions are in brackets [ ]

**BOLD PART NUMBER FOR GLOBALLY DESIGNED UNITS**

YORK INTERNATIONAL CORPORATION	ENGINEERED SYSTEMS (ESG) ENGINEERING STANDARD  TERMINALS-WIRE FOR ELECTRICAL CONDUCTORS AND TERMINAL HOUSINGS	STANDARD NO.	C-51
		PAGE	35 OF 41
		DATE	03-28-04
		SUPERSEDES	07-10-03
		ECN	0703-3026
		PREPARED BY	L.N. Fair
		APPROVED BY	B.A. Smith

TABLE 3.17

AMP Crimp Type Receptacles\*

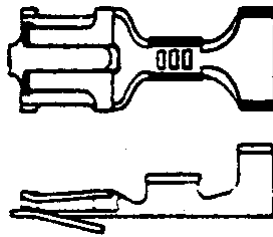

Wire Size	Wire Insulation O.D.	Recom. Wire Strip Length	Part Number	
			AMP	York
20 - 16	.080 - .150	3/16	61347-2	025-19690-000*

\* = Fits .187 +/- .005 wide x .020 +/- .002 thick tab  
All dimensions are for reference purposes only.  
Primary dimensions ( ) are American standard inches,  
metric millimeter dimensions are in brackets [ ]  
**BOLD PART NUMBER FOR GLOBALLY DESIGNED UNITS**

4. INSPECTION

4.1 At its option, ESG may inspect incoming shipments for compliance with this standard. However, the supplier is responsible for full conformance with this standard without dependence on ESG inspection.

5. APPROVED SOURCES OF SUPPLY

- (a) AMP Incorporated
- (b) Kent Division, The Thomas & Betts Co., for Terminal Adapters only
- (c) Kulka Smith, Inc., for Terminal Adapters only.
- (d) Marco Manufacturing, for Terminal Adapters only.

YORK INTERNATIONAL CORPORATION	ENGINEERED SYSTEMS (ESG) <u>ENGINEERING STANDARD</u>	STANDARD NO.	C-51
	TERMINALS-WIRE FOR ELECTRICAL CONDUCTORS AND TERMINAL HOUSINGS	PAGE	36 OF 41
		DATE	03-28-04
		SUPERSEDES	07-10-03
		ECN	0703-3026
		PREPARED BY	L.N. Fair
		APPROVED BY	B.A. Smith

6. PURCHASING

6.1 ESG Purchase Order shall specify:

- (a) Quantity
- (b) Type and Size
- (c) Manufacturer's name and part number
- (d) ESG Part Number
- (e) ESG Standard C-51

7. APPLICATION (ENGINEERED SYSTEMS INFORMATION ONLY)

- 7.1
- (a) For factory wiring of refrigeration, air conditioning, heating equipment, and control panels.
  - (b) The Ampere rating of the terminal shall be the same as that of the copper conductor AWG size being used.
  - (c) Where insulated terminals must be used to meet Underwriter's spacing requirements, designer must refer to vendor catalog for voltage rating.

7.2 Slotted Spring Spade Terminals:

- (a) Use the Plasti-Grip Slotted Spring Spade terminal, of Table 3.5(b) as the preferred standard.

7.3 The Solistrand Slotted Spring Spade Terminal Table 3.5(c) is for general use where insulation is not required. These terminals may be used with either stranded or solid wire. For No. 12 AWG and larger sizes, UL approval covers stranded wire only.

7.4 Ring-Tongue Type Terminals:

- (a) Plasti-Grip Ring-Tongue Terminals of Table 3.6(b) are recommended for non-military designs.
- (b) The Diamond Grip (PIDG) Ring-Tongue Terminals of Table 3.6(c) is more costly and shall be used only when required for Military Equipment.
- (c) The Terminal Ring-Tongue Terminal of Table 3.6(d) shall be used for large wire sizes. Where space is limited, the Solistrand Terminal of Table 3.6(e) may be used. Insulating Tubing shall be used over the Solistrand Terminal where required to meet Underwriter's Laboratories electrical spacing.
- (d) The Solistrand Ring-Tongue Terminal of Tables 3.6(e) is for general use where insulation is not required. These terminals may be used with either stranded or solid wire. For No. 12 AWG and larger sizes, UL approval covers stranded wire only.

YORK INTERNATIONAL CORPORATION	ENGINEERED SYSTEMS (ESG) <u>ENGINEERING STANDARD</u>  TERMINALS-WIRE FOR ELECTRICAL CONDUCTORS AND TERMINAL HOUSINGS	STANDARD NO.	C-51
		PAGE	37 OF 41
		DATE	03-28-04
		SUPERSEDES	07-10-03
		ECN	0703-3026
		PREPARED BY	L.N. Fair
		APPROVED BY	B.A. Smith

7.5 Push-On Type Terminals:

- (a) This type terminal permits much faster wiring on the equipment when the control device can be obtained with the matching male tab. They are limited, however, to the wire sizes listed in Table 3.7(c).
- (b) These terminals are supplied in reels for Automatic Machine Operation, except where the Table shows "loose piece" only.
- (c) Most small compressors are fitted with 1/4" x .032" male tabs. For this application, the gap dimensions of the terminal are increased from .060" and .065" to .115" and .120" respectively, to provide for the stud to which the tab is welded.
- (d) Insulation, if necessary, may be applied to the inside of the connection box, or an insulating sleeve heat shrunk over the applied terminal. The push-on terminals can be obtained in the pre-insulated form [See Table 3.7(f)]; however, different tooling is required.
- (e) Shop experience with .250" Push-On terminals has shown that a satisfactory grip can be made on the wire insulation even when the wire insulation diameter exceeds the recommended range by up to 50%.

7.5 Terminal Adapters, Push-On Type:

- (a) Table 3.7(g) shows push-on terminal adapters that are available.
- (b) The Dual Adapters, are used where two (2) male tabs are needed but only a single one is available. The electrical clearance must not be reduced below the allowed minimum.
- (c) The male tab shall be used to convert a screw terminal to a Push-On Type.

7.6 Terminal Wire Splices:

- (a) Table 3.8 shows the Butt and Closed End Type Splices.
- (b) These splices are used inside the electrical enclosures for joining conductors up to 300 volt AC rating. They shall not be used between enclosures or inside conduit.
- (c) Other splice connectors are available, see ESG Standard C-63.

YORK INTERNATIONAL CORPORATION	ENGINEERED SYSTEMS (ESG) <u>ENGINEERING STANDARD</u>  TERMINALS-WIRE FOR ELECTRICAL CONDUCTORS AND TERMINAL HOUSINGS	STANDARD NO.	C-51
		PAGE	38 OF 41
		DATE	03-28-04
		SUPERSEDES	07-10-03
		ECN	0703-3026
		PREPARED BY	L.N. Fair
		APPROVED BY	B.A. Smith

7.7 General:

- (a) Insulated terminals are required when it is possible to turn them on a stud or screw to a position where the required electrical spacing is reduced below that specified in the applicable Underwriters' Laboratories Standard.
- (b) Insulated terminals are made to be crimped over the insulation of the wire. The O.D. of the wire must therefore not exceed the I.D. of the insulation on the terminals.
- (c) The color code on Table 7.7(c) insures proper application of the terminals. The symbol (Sym.) shown indicates the proper tool for each type and size. Table 7.7(c) shows the proper tool marking on the applied terminal. If the tool marks do not agree with this data, the wrong tool has been used and the terminal may not be tight. A properly made terminal Joint will pass a pull test equal to 70-100% of the tensile strength of the wire.

TABLE 7.7(c)

Insulated spring Spade and Ring-Tongue Terminals										
Insulation Color	Small		Medium		Large		Heavy			
	AWG No.	Sym (*)	AWG No.	Sym (*)	AWG No.	Sym (*)	AWG No.	Sym (*)	AWG No.	Sym (*)
Red			22 - 16	*	8	8	2	2	3/0	3/0
Blue			16 - 14		6	6	0	0	4/0	4/0
Yellow	26 - 22	*	16 - 14HD	*	4	4	2/0	2/0		
Yellow			12 - 10	*						
Clear	24 - 20		*							

\* = The Sym. (Symbol) shown in this able indicates the marking left on the terminal to identify the tool used.

7.8 Terminals with Multiple Wires:

- (a) The AWG wire range of Table 3.8 is for a single conductor for a Butt Splice and Two (2) conductors for a Closed End Splice.
- (b) If additional wires are required, the terminal AWG size must be calculated. See paragraph 7.8(c).
- (c) Using Table 7.8(c1), add the CMA (Circular Mill Area) values of the required wires and select from Tabled 7.8(C2) the proper AWG Terminal Connector based on the total CMA value.

YORK INTERNATIONAL CORPORATION	ENGINEERED SYSTEMS (ESG) ENGINEERING STANDARD  TERMINALS-WIRE FOR ELECTRICAL CONDUCTORS AND TERMINAL HOUSINGS	STANDARD NO.	C-51
		PAGE	39 OF 41
		DATE	03-28-04
		SUPERSEDES	07-10-03
		ECN	0703-3026
		PREPARED BY	L.N. Fair
		APPROVED BY	B.A. Smith

TABLE 7.8 (c1)

Use to Convert Wire Gage to inches of Diameter, and CMA To read mils direct, move decimal point three places to the right					
AWG	Dia. (Inches)	CMA	AWG	Dia. (Inches)	CMA
4/0	0.460	212000.0	19	0.036	1290.0
3/0	0.410	168000.0	20	0.032	1020.0
2/0	0.365	133000.0	21	0.0285	810.0
1/0	0.325	106000.0	22	0.0253	642.0
1	0.289	83700.0	23	0.0226	509.0
2	0.258	66400.0	24	0.0201	404.0
3	0.229	52600.0	25	0.0179	320.0
4	0.204	41700.0	26	0.0159	254.0
5	0.182	33100.0	27	0.0142	202.0
6	0.162	26300.0	28	0.0126	160.0
7	0.144	20800.0	29	0.0113	127.0
8	0.128	16500.0	30	0.0100	101.0
9	0.114	13100.0	31	0.0089	79.7
10	0.102	10400.0	32	0.0080	63.2
11	0.091	8230.0	33	0.0071	50.1
12	0.081	6530.0	34	0.0063	39.8
13	0.072	5180.0	35	0.0056	31.5
14	0.064	4110.0	36	0.0050	25.0
15	0.057	3260.0	37	0.0045	19.8
16	0.051	2580.0	38	0.0040	15.7
17	0.045	2050.0	39	0.0035	12.5
18	0.040	1620.0	40	0.0031	9.9

All dimensions are for reference purposes only.

TABLE 7.8 (c2)

AMP Range Chart Use to select the proper size terminal or splice			
Terminal Connector Size	CMA Range	Terminal Connector Size	CMA Range
26 - 22	202 - 810	6	20800 - 33100
24 - 18 H.D.	320 - 2050	4	33100 - 52600
22 - 16	509 - 3260	2	52600 - 83700
22 - 14	509 - 5180	1/0	83700 - 119500
20 - 16 H.D.	810 - 3260	2/0	119500 - 150500
16 - 14	2050 - 5180	3/0	150500 - 190000
16 - 14 H.D.	2050 - 5180	4/0	190000 - 231000
16 - 10	2050 - 13100	250 - 300 MCM	231000 - 300000
14 - 12	3260 - 8230	300 - 350 MCM	300000 - 380000
12 - 10	5180 - 13100	400 MCM	380000 - 478000
8	13100 - 20800	500 - 600 MCM	478000 - 600000

YORK INTERNATIONAL CORPORATION	ENGINEERED SYSTEMS (ESG) ENGINEERING STANDARD  TERMINALS-WIRE FOR ELECTRICAL CONDUCTORS AND TERMINAL HOUSINGS	STANDARD NO.	C-51
		PAGE	40 OF 41
		DATE	03-28-04
		SUPERSEDES	07-10-03
		ECN	0703-3026
		PREPARED BY	L.N. Fair
		APPROVED BY	B.A. Smith

7.8 (Continued)

- (e) Based on CMA and insulation thickness the following terminals should be used for multi-wire applications requiring Series 250 terminals:

TABLE 7.8 (c3)

Wire - Insulation Thickness	Terminals	
	Straight	Flag
Two (2) #18 - 2/64	025-17076-000	N/A
Two (2) #16 - 2/64	025-17076-000	N/A
One (1) #16 - 2/64 & One (1) #16 - 4/64	N/A	N/A
One (1) #16 - 2/64 & One (1) #12 - 2/64	025-17076-000	N/A
Two (2) #14 - 2/64	025-17076-000	N/A
One (1) #14 - 2/64 & One (1) #12 - 2/64	N/A	N/A

MOD IV WIRE - APPLIED HOUSINGS

SINGLE ROW .100 CENTERS

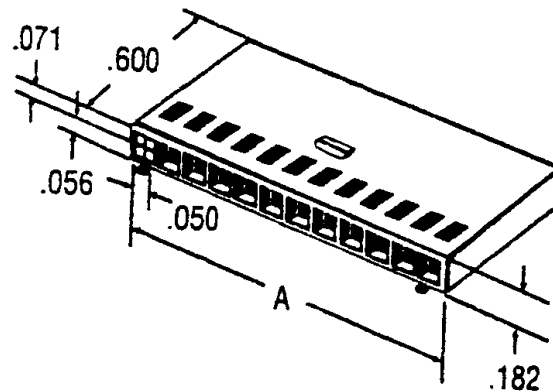

No. Of Positions	Diam. A	Housing Cap Part Number	
		AMP	YORK
7	0.7	102241-5	025-35971-000

YORK INTERNATIONAL CORPORATION	ENGINEERED SYSTEMS (ESG) ENGINEERING STANDARD  TERMINALS-WIRE FOR ELECTRICAL CONDUCTORS AND TERMINAL HOUSINGS	STANDARD NO.	C-51
		PAGE	41 OF 41
		DATE	03-28-04
		SUPERSEDES	07-10-03
		ECN	0703-3026
		PREPARED BY	L.N. Fair
		APPROVED BY	B.A. Smith

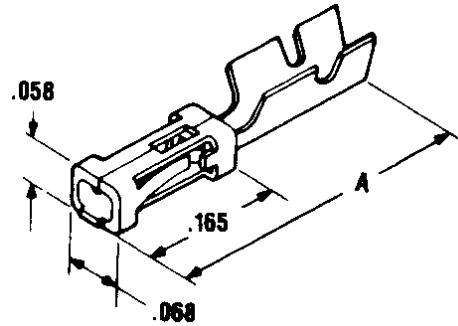

CONTACTS      STANDARD PRESSURE

Wire Size	Wire Ins. O.D.	Recom. Wire Strap Length	Part Number	
			AMP	YORK
24 - 20	.069	5/32	1-87523-6	025-35970-000