

CHILLER SYSTEM INTERFACE

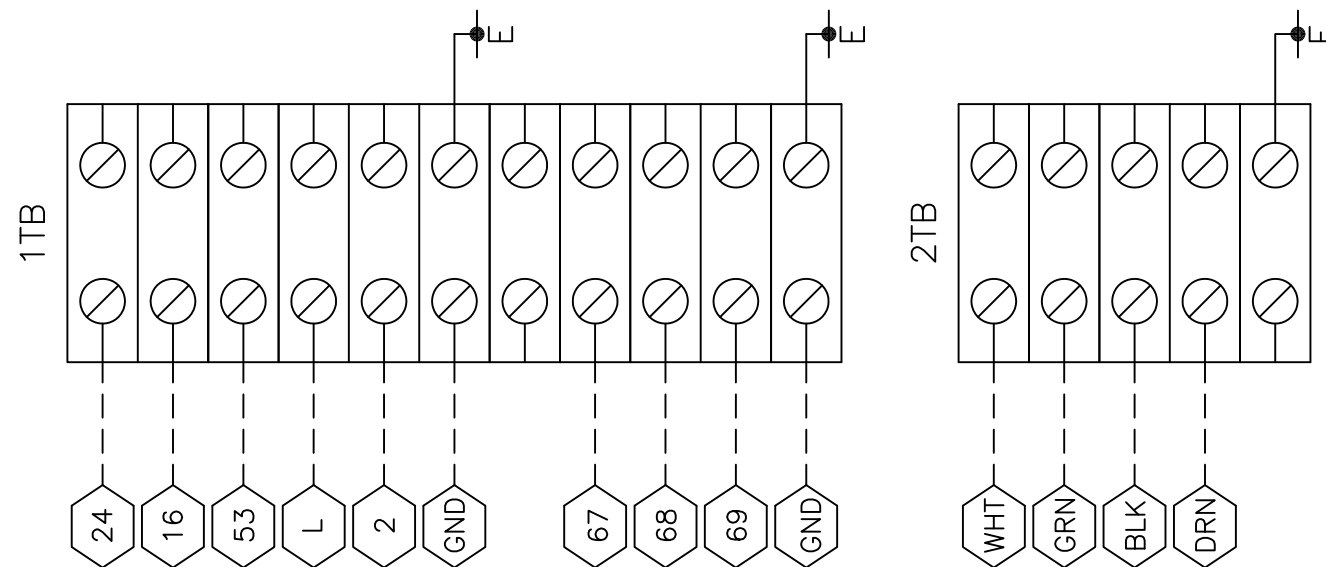

CUSTOMER TERMINAL BLOCK

REV. LEV.	DATE	REVISION RECORD	CHG. NO.	DR.	CK.	REV. LEV.	DATE	REVISION RECORD	CHG. NO.	DR.	CK.	REV. LEV.	DATE	REVISION RECORD	CHG. NO.	DR.	CK.
6						13						20					
5						12						19					
4						11						18					
3						10						17					
2						9						16					
1	02/05/08	REMOVED 2TB JUMPER		OB	AL	8						15					
0	08/24/06	FIRST ISSUE		OB	AL	7						14					

*ALL PROPRIETARY RIGHTS IN THE SUBJECT MATTER HEREOF ARE RESERVED, AND NO PERMISSION IS GRANTED TO REPRODUCE THIS PRINT IN WHOLE OR IN PART, OR DISCLOSE ANY OF THE INFORMATION UPON IT TO OTHERS WITHOUT WRITTEN RELEASE BY YORK INTERNATIONAL CORPORATION.

YORK INTERNATIONAL CORPORATION YORK, PA . 17405			
DIMENSIONS ARE IN INCHES DO NOT SCALE TOLERANCES PER ENG. STD. M-282 WELDING PER ENG. STD. M-30 REF. DWG.	CHILLER SYSTEM TERMINAL CONNECTIONS	MATERIAL TYPE _____ ENG. STD. _____ PART NO. _____ CUT SIZE _____	
DR. _____ APPR. _____ SCALE: _____	NAME _____ DATE _____ SIZE D	CAGE NO. _____ ORIG. NO. _____	DRAWING NUMBER 1808K528 SHEET 14 of 15
WT. = _____ LBS.		SHEET 14 of 15	