



BY JOHNSON CONTROLS

New Release

Form: 160.78-PW4 (912)

OPTISPEED VARIABLE SPEED DRIVE MODEL HYP744 AND HYP490

WIRING DIAGRAMS

CONTRACTOR _____
ORDER NO. _____
JCI CONTRACT NO. _____
JCI ORDER NO. _____

PURCHASER _____
JOB NAME _____
LOCATION _____
ENGINEER _____

REFERENCE DATE _____

APPROVAL DATE _____

CONSTRUCTION DATE _____

JOB DATA:

CHILLER MODEL NO. _____ NO. OF UNITS _____

COMPRESSOR MOTOR _____ VOLTS, 3-PHASE _____ HZ

VARIABLE SPEED DRIVE, MODEL NO. VSD _____ - _____

Issue Date:
September 10, 2012



IMPORTANT!

READ BEFORE PROCEEDING!

GENERAL SAFETY GUIDELINES

This equipment is a relatively complicated apparatus. During installation, operation maintenance or service, individuals may be exposed to certain components or conditions including, but not limited to: refrigerants, materials under pressure, rotating components, and both high and low voltage. Each of these items has the potential, if misused or handled improperly, to cause bodily injury or death. It is the obligation and responsibility of operating/service personnel to identify and recognize these inherent hazards, protect themselves, and proceed safely in completing their tasks. Failure to comply with any of these requirements could result in serious damage to the equipment and the property in

which it is situated, as well as severe personal injury or death to themselves and people at the site.

This document is intended for use by owner-authorized operating/service personnel. It is expected that these individuals possess independent training that will enable them to perform their assigned tasks properly and safely. It is essential that, prior to performing any task on this equipment, this individual shall have read and understood this document and any referenced materials. This individual shall also be familiar with and comply with all applicable governmental standards and regulations pertaining to the task in question.



External wiring, unless specified as an optional connection in the manufacturer's product line, is not to be connected inside the OptiView cabinet. Devices such as relays, switches, transducers and controls and any external wiring must not be installed inside the micro panel. All wiring must be in accordance with Johnson Controls' published specifications and must

be performed only by a qualified electrician. Johnson Controls will NOT be responsible for damage/problems resulting from improper connections to the controls or application of improper control signals. Failure to follow this warning will void the manufacturer's warranty and cause serious damage to property or personal injury.

CHANGEABILITY OF THIS DOCUMENT

In complying with Johnson Controls' policy for continuous product improvement, the information contained in this document is subject to change without notice. While Johnson Controls makes no commitment to update or provide current information automatically to the manual owner, that information, if applicable, can be obtained by contacting the nearest Johnson Controls Service office.

Operating/service personnel maintains the responsibility of the applicability of these documents to the competitive equipment the kit is installed on. If there is any question regarding the applicability of these documents, the technician should verify whether the equipment has been modified and if current literature is available with the owner of the equipment prior to performing any work on the chiller.

LEGEND

1C - 9C	CAPACITOR, FILM, INPUT POWER FILTER, 50 μ F, 55AMPS, 5%, 400VAC
10C - 12C	CAPACITOR, FILM, DC LINK, 1500 μ F, 530AMPS, 1000VDC
13C - 30C	CAPACITOR, FILM, SNUBBER, 1.0 μ F, 1200VDC
31C	CAPACITOR, FILM, 20 μ F, 400VAC
32C - 43C	CAPACITOR, FILM, 50 μ F, 530VAC
IDSW	SWITCH DISCONNECT, 1200AMPS, 600VAC, 100KA, WITHSTAND
ISW	CIRCUIT BREAKER, 1200AMPS, 600VAC, 100KA, WITHSTAND
IDCCT - 3DCCT	DC CURRENT TRANSFORMER, INPUT, 5000 AMPS TO 1 AMPS
4DCCT - 6DCCT	DC CURRENT TRANSFORMER, OUTPUT, 5000 AMPS TO 1 AMPS
1FU - 3FU	FUSE, INPUT POWER, 800A, 700VAC, 200KA, INTERRUPTING SEMICONDUCTOR
4FU - 6FU	FUSE, INPUT VOLTAGE SENSE, 1A, 600 VAC, 200KA INTERRUPTING
7FU - 10FU	FUSE, CONTROL SUPPLY XFMR PRIMARY, 10A, 600VAC, 200KA INTERRUPTING
11FU	FUSE, EXTERNAL CONTROL SUPPLY XFMR SECONDARY, 20A, 600VAC, 200KA INTERRUPTING
12FU	FUSE, INTERNAL CONTROL SUPPLY XFMR SECONDARY, 20A, 600VAC, 200KA INTERRUPTING
13FU	FUSE, INTERNAL CONTROL SUPPLY XFMR SECONDARY, 7A, 600VAC, 200KA INTERRUPTING
14FU	FUSE, GATE DRIVER CONTROL SUPPLY XFMR PRIMARY, 7A, 600VAC, 200KA INTERRUPTING
15FU	FUSE, GATE DRIVER CONTROL SUPPLY XFMR SECONDARY, 7A, 600VAC, 200KA INTERRUPTING
16FU - 18FU	FUSE, TRANSIENT SUPPRESSOR PCB, 5A, 600VAC, 200KA INTERRUPTING
19FU - 21FU	FUSE, OUTPUT VOLTAGE SENSE, 1A, 600VAC, 200KA INTERRUPTING
25FU, 26FU	FUSE, DC, 8A, 1000V
27FU	FUSE, INPUT VOLTAGE COMMON MODE, 20A, 600VAC, 200KA, INTERRUPTING
1L	INDUCTOR, LINE, 27.5 μ H, 914 AMPS, 600VAC
2L	INDUCTOR, DRIVE, 82.5 μ H, 914 AMPS, 600VAC
3L	INDUCTOR, OUTPUT, 28 μ H, 550 AMPS, 600VAC
1MOD - 12MOD	MODULE, POWER DUAL, ACTIVE CONVERTER, 300AMPS, 1200VAC
13MOD - 18MOD	MODULE, POWER DUAL, INVERTER, 450A, 1200VAC
1R	RELAY, COOLING FANS AND PUMP
1RES - 3RES	RESISTOR, INPUT POWER FILTER, BLEEDER, 20K, 16W, 5%
4RES - 10RES	RESISTOR, DC LINK, 20K, 16W, 5%
1RT - 2RT	THERMISTOR, AMBIENT, 10K AT 25°C
1T - 2T	TRANSFORMER, CONTROL 2KVA, 480VAC:120VAC
3T - 4T	TRANSFORMER, CLASS 2, 75VA, 120VAC:24VAC
5T	TRANSFORMER, CONTROL 175VA, 120VAC:32VAC
1TB	TERMINAL BLOCK, CONTROL POWER AND OIL PUMP SUPPLY
2TB	TERMINAL BLOCK, COMMUNICATIONS
3TB	TERMINAL BLOCK
4TB	TERMINAL BLOCK, MTR THERMISTORS
5TB	TERMINAL BLOCK, FANS
MBC	MAGNETIC BEARING CONTROLLER

SYSTEM NOMENCLATURE

Y M C 2 - S 0756 A A

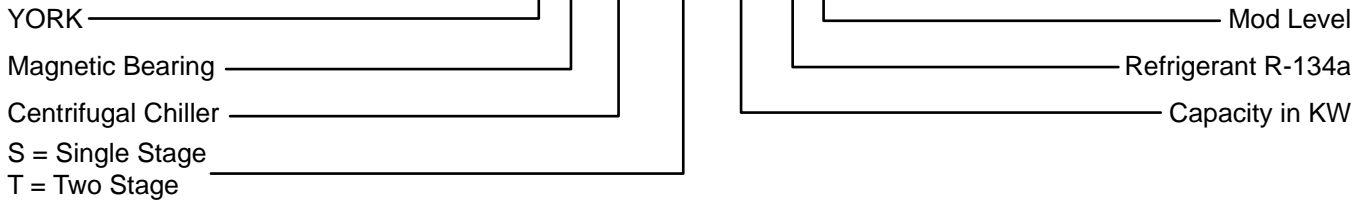

COMPRESSOR NOMENCLATURE

M1 B - 197 F A A

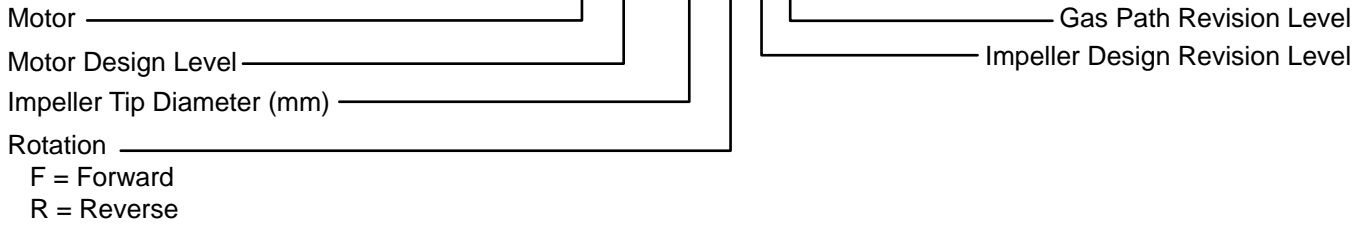

VESSEL NOMENCLATURE

E A 25 14 271 B R 1 1 F C R

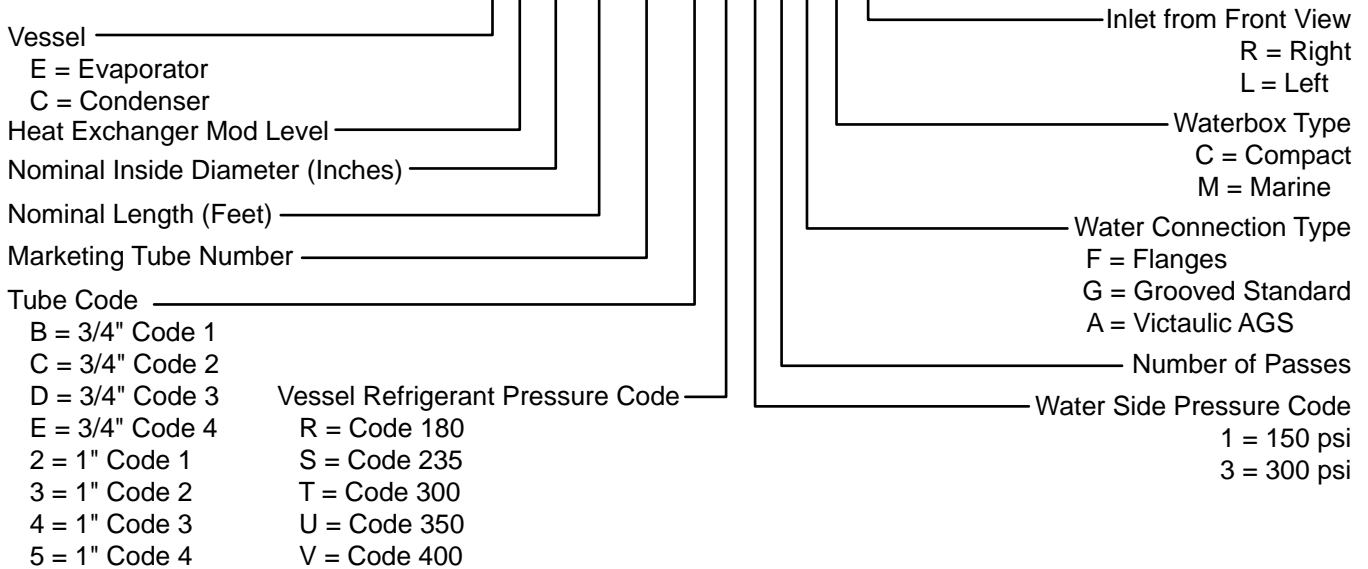

VARIABLE SPEED DRIVE NOMENCLATURE

HYP 744 X H 15 D - 40

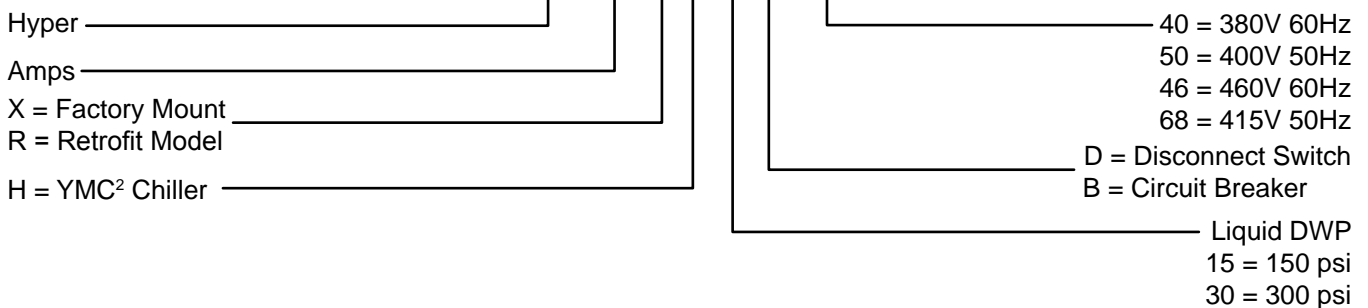

NOTES

1. Field wiring to be in accordance with the national electrical code as well as all other applicable codes and specifications.
2. Terminal block connection points are indicated by numbers within a square, I.E. $\boxed{1}$ 2TB main power connection points are indicated by numbers within a hexagon, I.E. $\hexagon{L1}$ Component terminal markings are indicated by numbers within a circle, I.E. $\textcircled{2}$ Numbers adjacent to circuit lines are the circuit identification numbers.
3. Terminals L1, L2, L3 and GRD are the main power input terminals and are field connected. (See note 6.) Terminals T1, T2 and T3 are the compressor motor lead power terminals and are factory connected on factory package units.
4. The three phase solid state motor overload protection system provides motor overcurrent protection at 105% full load amps.
5. See YORK Control Center wiring diagram product drawing form 160.78-PW2.
6. Field wiring connections per product drawing form 160.78-PW1.

CONTROL WIRING FOR HYP744 (CONT'D)

035-23032-001
 REV. A

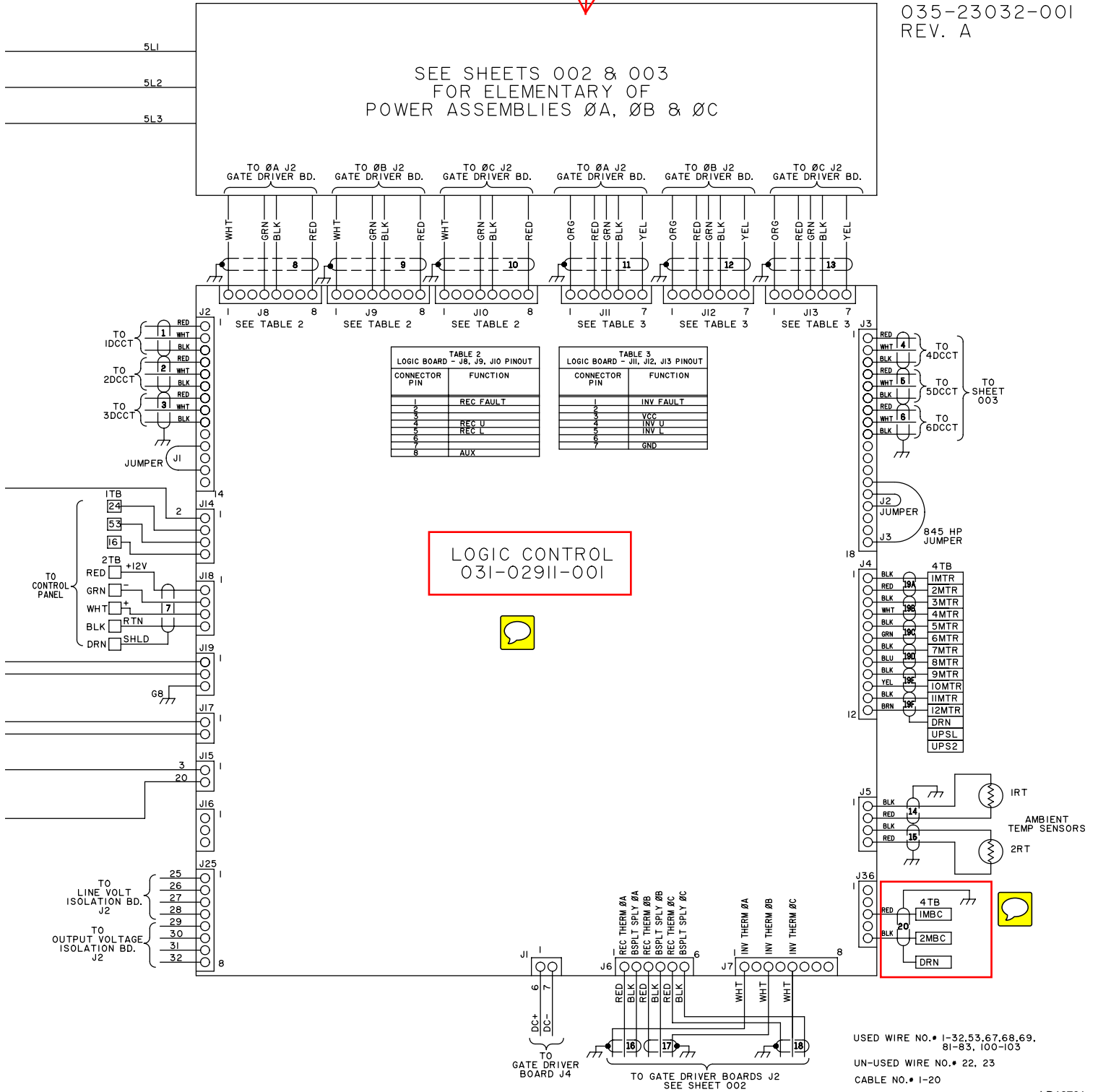
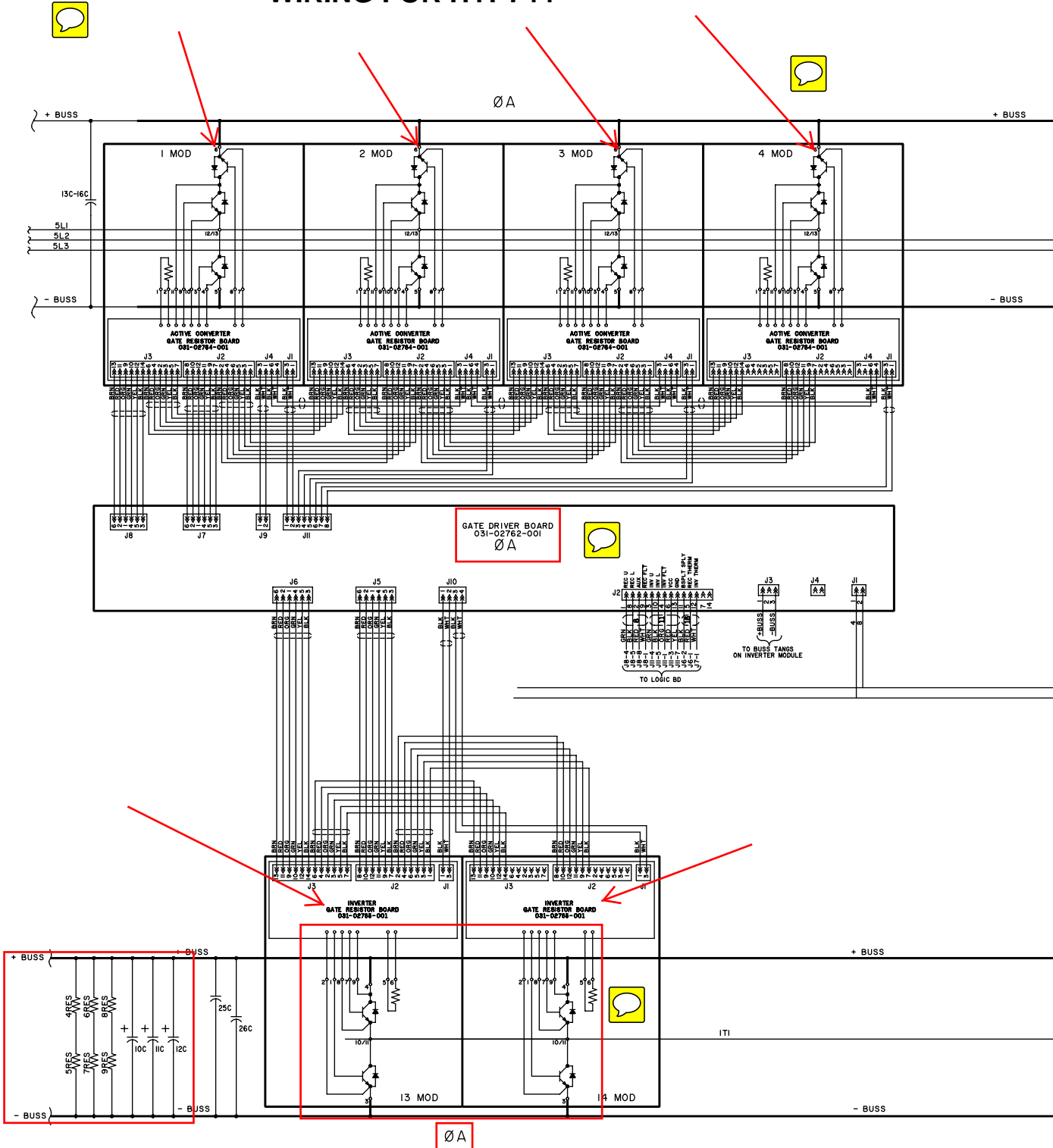

FIGURE 1 - CONTROL WIRING FOR HYP744 (CONT'D)

WIRING FOR HYP744



LD16702

FIGURE 2 - WIRING FOR HYP744

WIRING FOR HYP744 (CONT'D)

035-23032-002
 REV. A

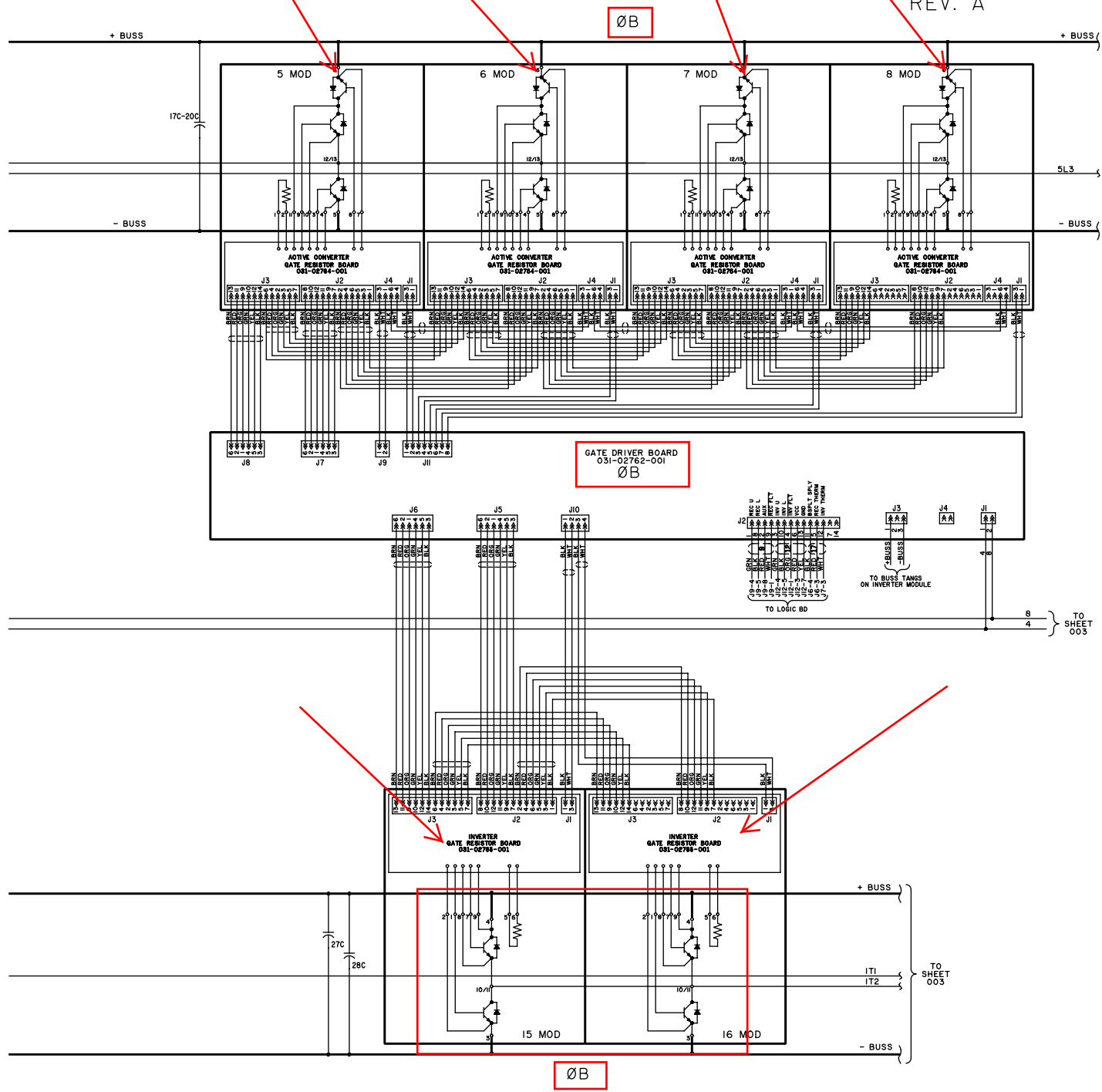
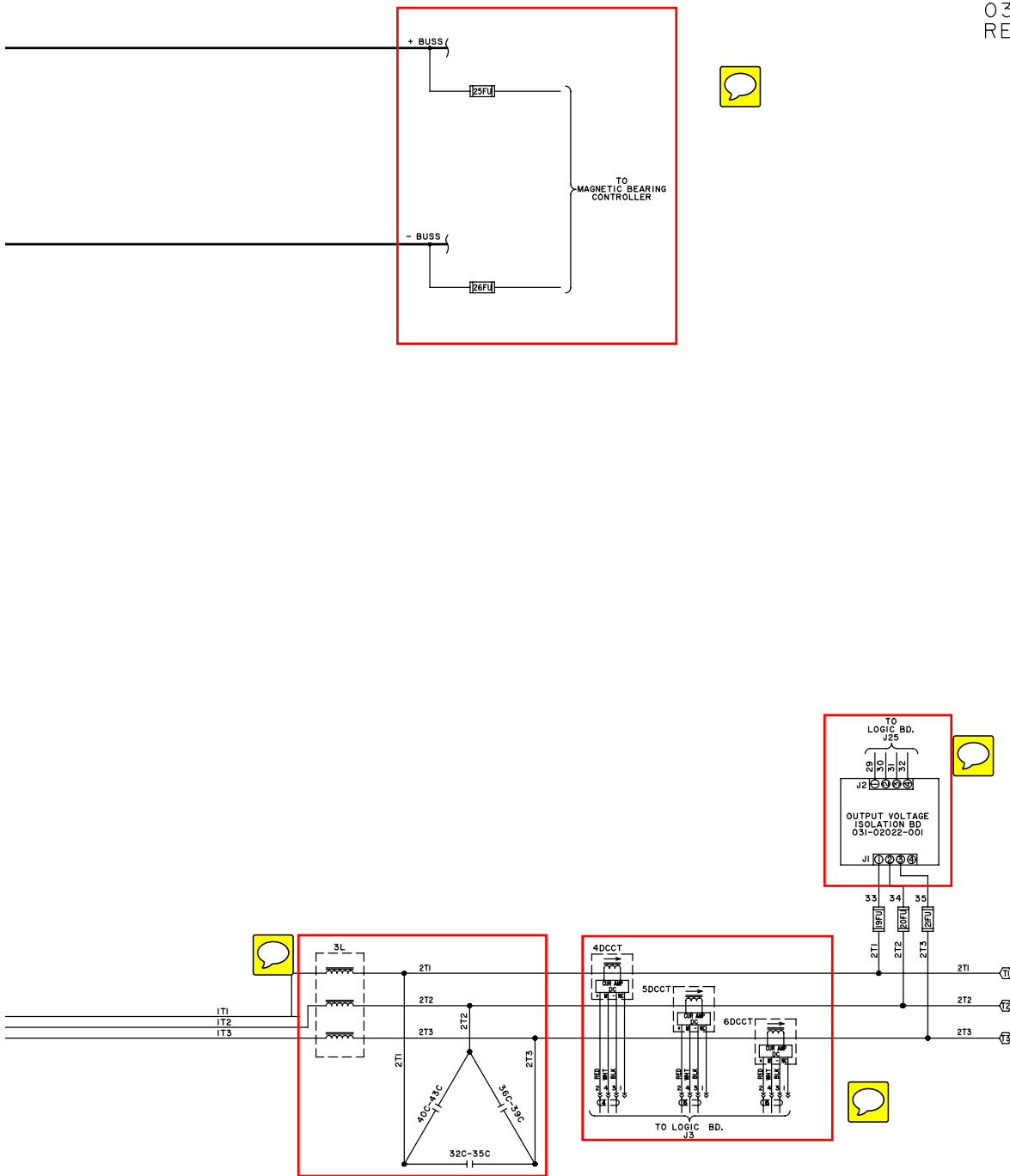

FIGURE 2 - WIRING FOR HYP744 (CONT'D)

LD16703

POWER SUPPLY WIRING FOR HYP744 (CONT'D)

035-23032-003
 REV. A



LD16705

FIGURE 3 - POWER SUPPLY WIRING FOR HYP744 (CONT'D)

CONTROL WIRING FOR HYP490

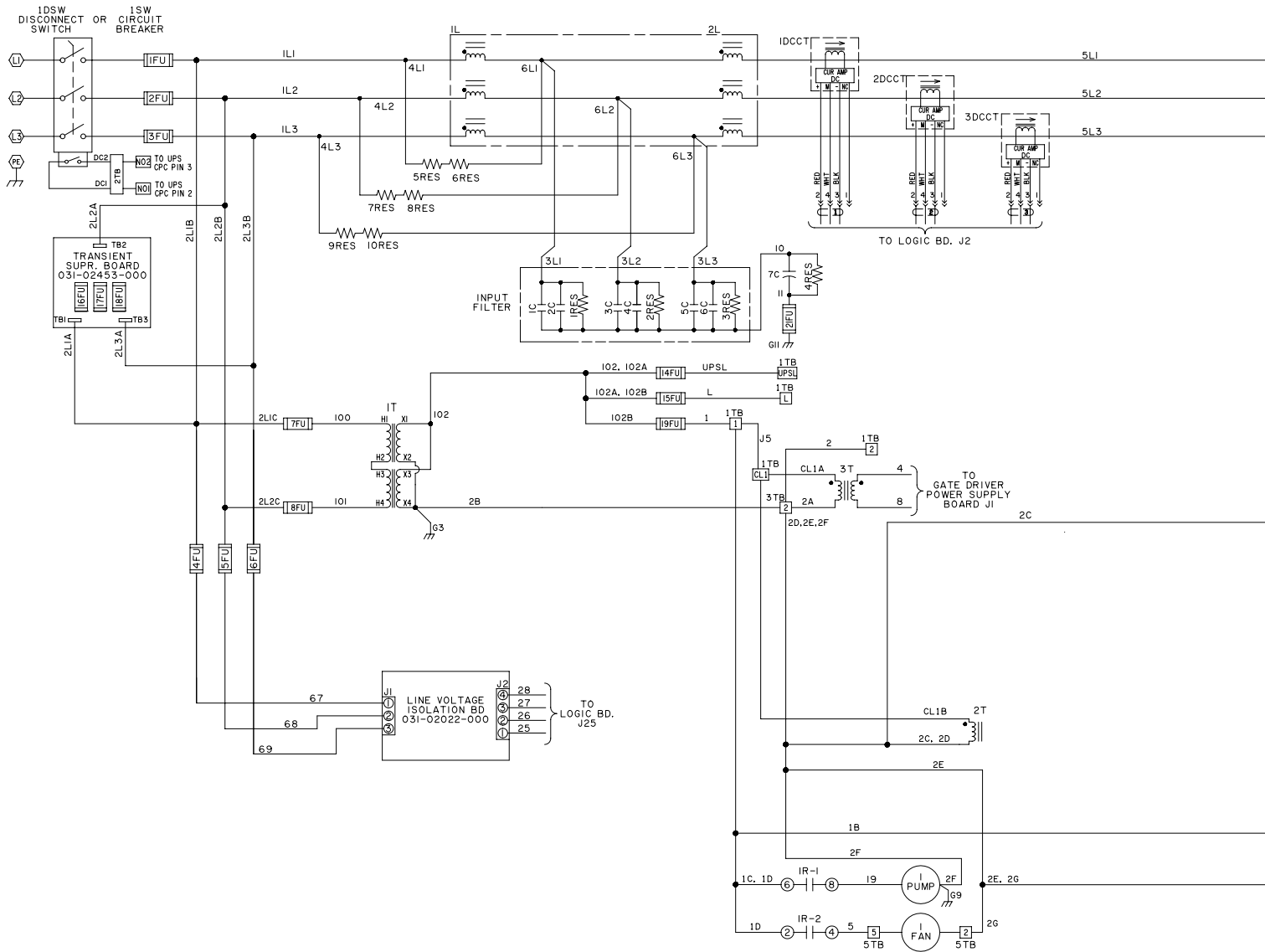

LD16710

FIGURE 4 - CONTROL WIRING FOR HYP490

CONTROL WIRING FOR HYP490 (CONT'D)

035-23185-001
 REV. A

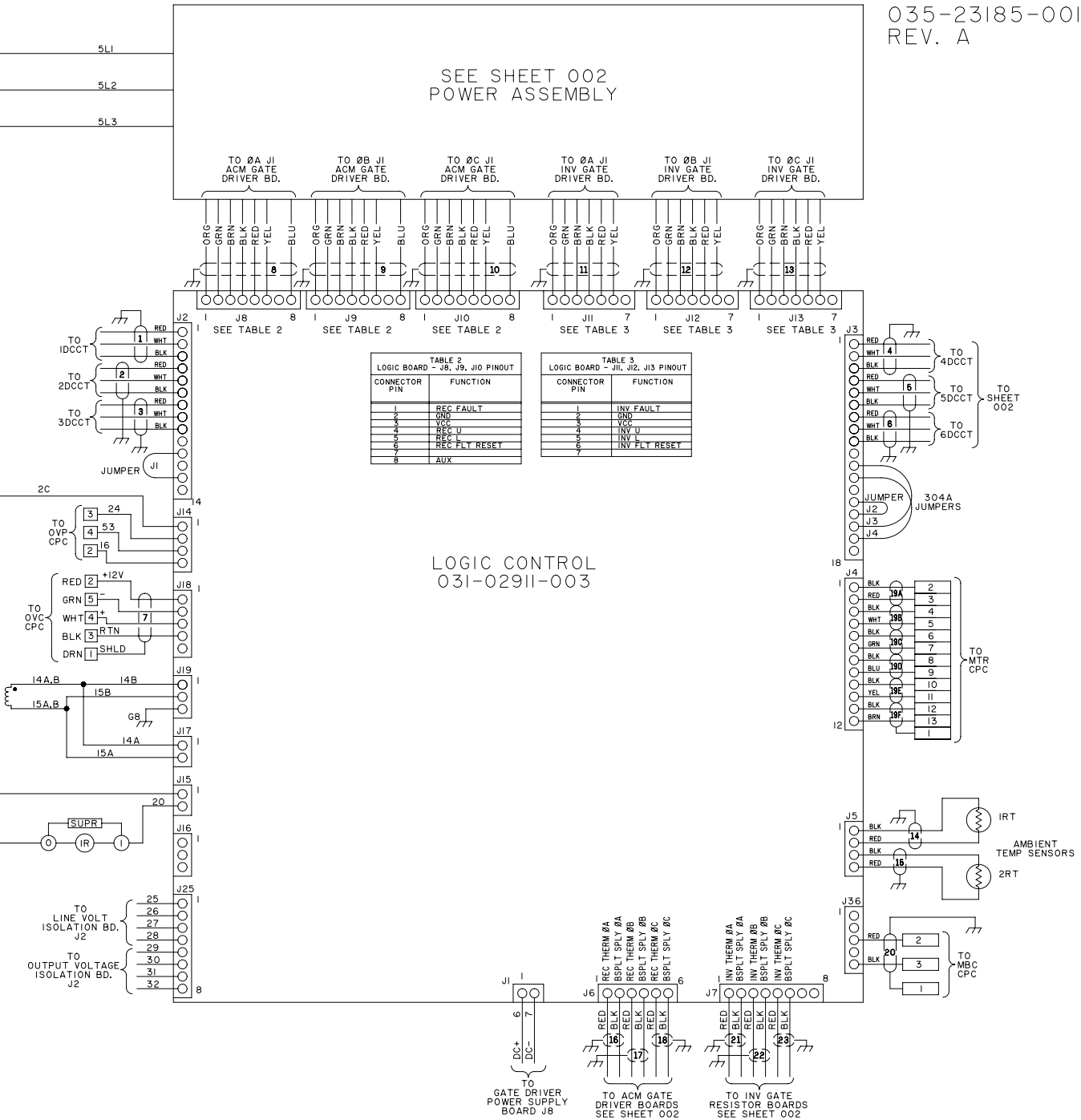
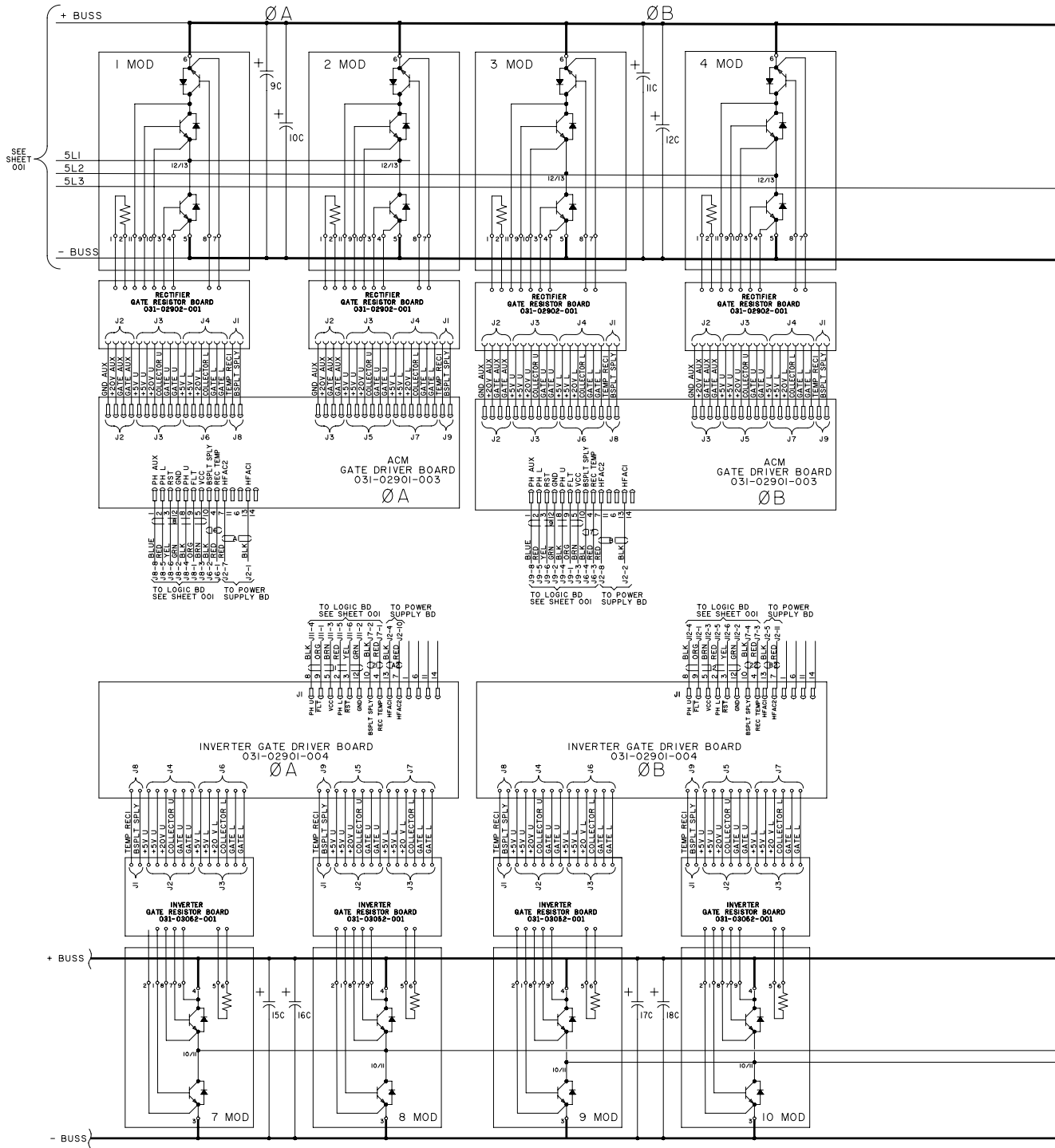

FIGURE 4 - CONTROL WIRING FOR HYP490 (CONT'D)

WIRING FOR HYP490



LD16712

FIGURE 5 - WIRING FOR HYP490

WIRING FOR HYP490 (CONT'D)

035-23185-002
 REV. A

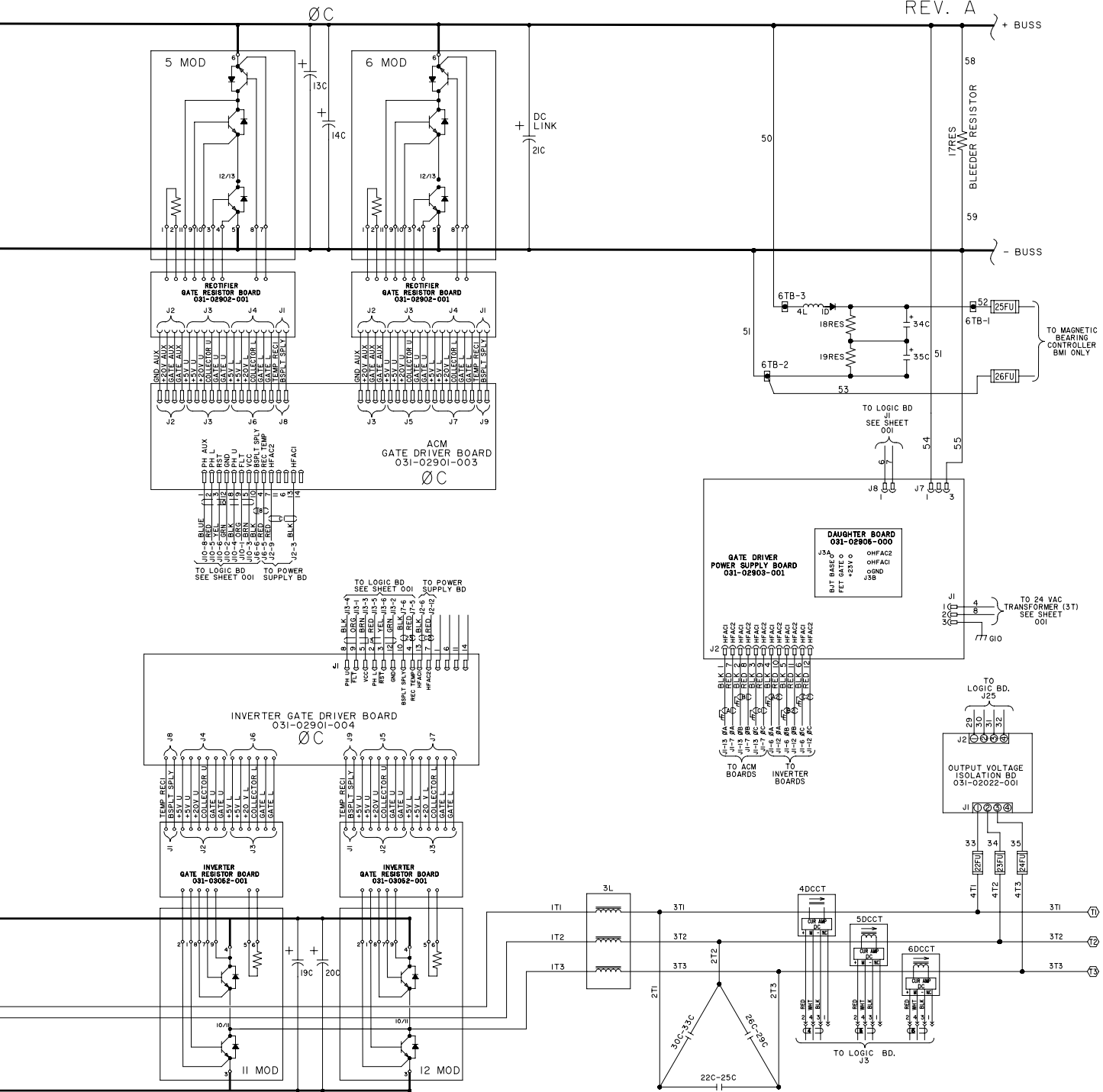

FIGURE 5 - WIRING FOR HYP490 (CONT'D)



P.O. Box 1592, York, Pennsylvania USA 17405-1592
Copyright © by Johnson Controls 2012

Form 160.78-PW4 (912)
Issue Date: September 10, 2012
New Release

800-861-1001
www.johnsoncontrols.com

Subject to change without notice. Printed in USA
ALL RIGHTS RESERVED