

MicroTech Centrifugal Control System Application Manual

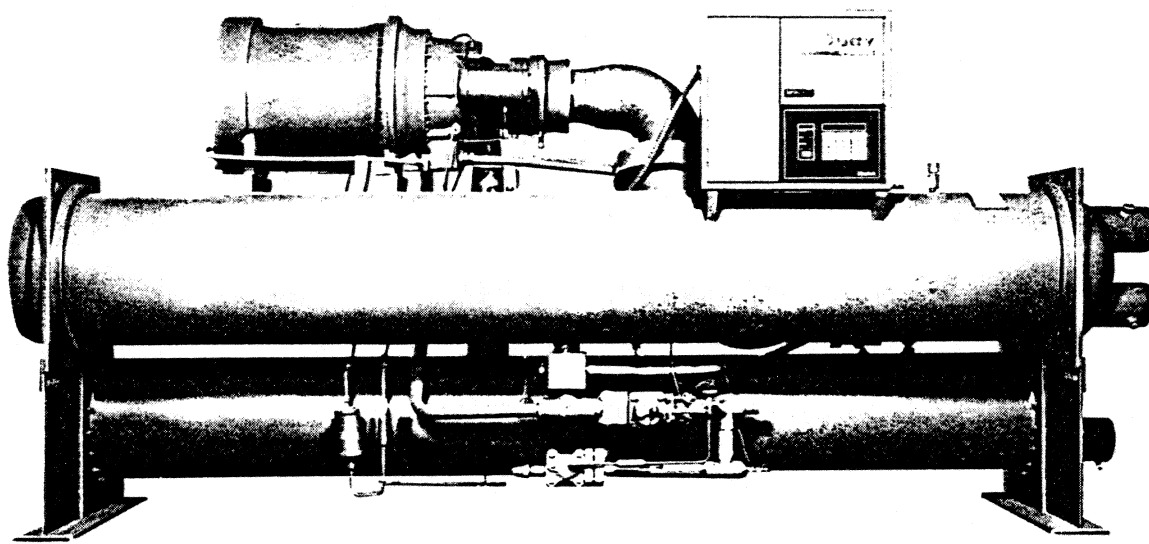

McQuay
Air Conditioning

TABLE OF CONTENTS

	PAGE
I. INTRODUCTION/OVERVIEW	3
A. Purpose For MicroTech	3
B. Production on PEH and PFH Units	3
II. PANEL CONFIGURATION	3
A. Panel Front	3
B. Display Window	4
C. Microprocessor Status Section	4
D. Keypad Section: DISPLAY, SETPOINTS, & SERVICE	4
E. Mother Board	5
F. Daughter Board	6
G. Output Board	6
H. Display Microprocessor	7
I. Terminal Strip	7
J. Mechanical Backup Safeties	7
III. FIELD WIRING	8
A. PEH Field Wiring	8
B. PFH Field Wiring	9
C. MicroTech Wiring Schematic	10
D. LLLB Field Wiring	11
E. Sensor Location	12
IV. DISPLAYED VALUES AND SETPOINTS	13
A. Display Values	13
B. Setpoints	19
C. Service Setpoints	25
V. START-UP, OPERATION & SHUTDOWN SEQUENCE	33
A. Unit OFF	33
B. Starting Unit	34
C. Service Setpoints	35
VI. PROGRAMMING MICROTCH	37
A. Water Temperature	37
B. Maximum Amp Limit	38
C. Soft (Ramp) Loading	39
D. Timeclock, Time Schedule and Holiday Schedule	39
E. Set-up Options	40
VII. LEAD/LAG — LOAD/BALANCE (LLL) SYSTEM CONTROLLER	44
A. Dual (PFH and Two Unit (2 × PEH) Applications	44
B. Lead/Lag Operation	45
C. Automatic Startup on Safety Shutdown	46
D. Load Balance Operation	46
E. Field Connection and EMS Interface	46
F. Panel Configuration	47
G. Special Considerations	47

"McQuay" and "MicroTech" are registered trademarks of the Commercial Products Group.
SnyderGeneral Corporation, Minneapolis, Minnesota.

Copyright © 1988 SnyderGeneral Corporation. All rights reserved throughout the world.

"Bulletin illustrations cover the general appearance of SnyderGeneral products at time of publication and
we reserve the right to make changes in design and construction at any time without notice."

I. Introduction

A. Purpose For MicroTech

MicroTech is a microprocessor based chiller control system used on centrifugal chillers. MicroTech is the main control device that senses the system load and controls the compressor capacity accordingly by loading/opening or unloading/closing the inlet guide vanes. The MicroTech system monitors all safety and operating controls of the entire unit and maintains machine operation within prescribed limitations.

The MicroTech system was designed with the user in mind. With the advancements in microprocessor computer control and logic, McQuay has assembled a truly user-friendly interface and control panel. This enables the operator to control all setpoints and allows for true chiller energy management.

The user interface is through a keypad on the front of the control panel and displayed values are viewed on a 20 character display window.

B. Production on PEH and PFH Units

MicroTech is a factory mounted and wired system that has been available as standard on production centrifugals (PEH and PFH) since August 1987. The MicroTech control package includes all temperature and pressure sensors required for safe operation and unit monitoring. Contact your local McQuay representative for correct panel identification. For retrofit applications of MicroTech on existing units, contact McQuay Service.

Figure 1.

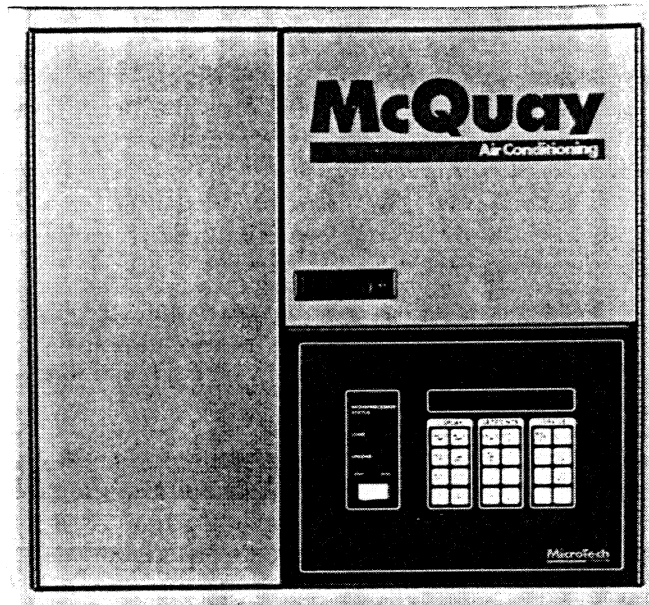

II. Panel Configuration

A. Panel Front

The MicroTech control panel is unit mounted on the front of all units. For detail of panel location consult certified drawings for location and size. The control panel is divided into 3 separate hinged doors. The upper right-hand door contains the door latch and lock (panel is shipped unlocked with keys wire-locked to inside of lock mechanism). See Figure 1.

The lower right panel contains the main interface device, or Display Processor, used for controlling all unit functions and accessing operating conditions, setpoints, status points, etc., of the centrifugal chiller. See the next page for display layout.

The left-hand door covers field wiring terminal section for all input and output wiring.

B. Display Window

The Display processor consists of three main areas: 20 character display, microprocessor status section, and keypad. The 20 character vacuum fluorescent display (visible in all lighting conditions) outputs all messages in plain English (not 2-digit codes) in order to better communicate operating conditions. See Figure 2.

Figure 2.

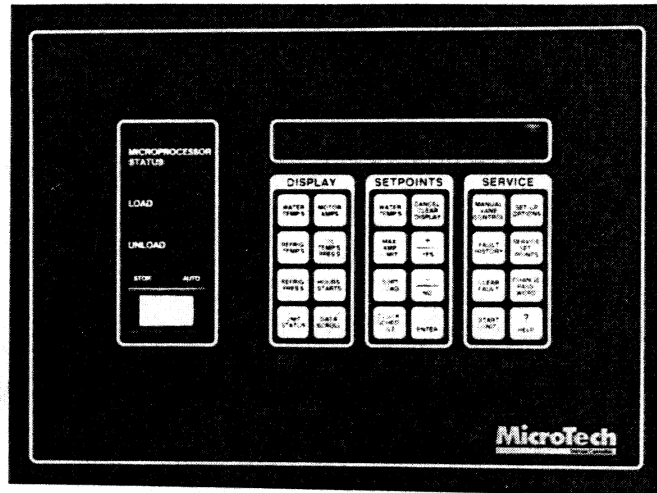

C. Microprocessor Status Section

The Microprocessor status section consists of 3 status lights and a unit control switch. The MICROPROCESSOR STATUS light is a continuously blinking fluorescent light communicating between microprocessors (Display processor and Main processor) that each are in proper operating condition. The “blinking” STATUS light is used to show that each processor is operating properly in watch-dog fashion [“I’m OK—are you OK?”]. A continuously “ON” or continuously “OFF” MICROPROCESSOR STATUS status light indicates that a software, a hardware, or a communication failure has occurred between the two processors and service personnel should be contacted.

Below the MICROPROCESSOR STATUS light are the “LOAD” and “UNLOAD” lights. If the machine is loading (increasing capacity), the load light will be “ON” or illuminated as the Microprocessor controller opens the inlet guide vanes. Similarly, the UNLOAD light will be “ON” whenever the unit is unloading (reducing capacity) and closing the inlet guide vanes.

At the bottom of the status section is an “OFF/AUTO” switch used to control the overall LOCAL mode or operation status of the chiller. With the switch in the “OFF” position, the machine will remain OFF until its position has been manually changed to the “AUTO” position and “START UNIT” has been requested. The unit will then start in normal fashion provided the CLOCK & HOLIDAY schedule is satisfied, and a load exists.

If the unit has shut down due to an operating safety or fault, the switch must remain in the auto position and the fault cleared by depressing “CLEAR FAULT” and then requesting to “START UNIT.” This makes sure the unit operator has diagnosed the fault condition and made proper changes thus insuring proper system operation.

D. Keypad Section: DISPLAY, SETPOINTS, & SERVICE

The keypad consists of 24 tactile feedback interface switches and is divided into three main sections: DISPLAY, SETPOINTS and SERVICE. “DISPLAY” keys are used to view any of the current operating conditions of the unit. For example, by pressing the “WATER TEMP’S” key once, the 20 character output display will show “LEAVING EVAP = 43.8”. This is the actual leaving chilled water temperature that the machine is currently producing. Pushing the water temperature key again will display the ENTERING EVAP temperature. Other operating conditions accessible through the keypad “DISPLAY” section are REFRIG TEMP’S and PRES’S, MOTOR AMPS and RLA, OIL TEMPS AND PRES’S, UNIT STATUS and ELAPSED TIME and NUMBER OF STARTS (see Section IV. Displayed Values and Setpoints for complete listing and access procedure). The “DISPLAY” section of the keypad does not require any type of passwords to display values.

The center section of the keypad is used for "SETPOINT" display and control and accesses the current operating setpoints of the machine. This includes the chilled water setpoint, local demand limiting (AMP LIMITING) control, soft load (RAMP LOADING) functions, and time schedule/holiday features. In order to change any existing setpoints, the operator must have input the "OPERATOR" password. See Section IV-B for entering "OPERATOR" password.

The third keypad section is "SERVICE". This section is used for the set-up options or to customize the MicroTech features to a particular unit and the exact job situations. For example, under "SET-UP OPTIONS" different types of reset can be programmed into MicroTech such as CHW (reset of chilled water setpoint from a remote EMS 4-20 mA DC signal), ENT (reset leaving chilled water based on return water temperature), START/STOP method (local or remote), etc. The programming of "SET-UP OPTIONS" requires the operator's password in order to change default values (see Section IV-C. Service Setpoints for default values and operator procedures).

Also under the "SERVICE" keys are functions such as "MANUAL VANE CONTROL" and "SERVICE SETPOINTS." This allows qualified service personnel to control or change functions such as manual vane control (for service purposes only) and safety setpoints (such as High Discharge Temperature safety setpoint) that are usually never changed from the factory programmed values. The Service Setpoints key is protected by the "SERVICE" password.

The "SERVICE" section also includes a "FAULT HISTORY" key, used to display the current safety shutdown or fault and the previous 8 safety shutdowns or faults that have taken place, and a "START UNIT" key, used to restart the unit after a safety shutdown (and clearing fault by pressing "CLEAR FAULT" button) or after switching the OFF/AUTO key to the AUTO position to initially start the unit. A password is not required in order to "CLEAR FAULT" or request start-up of the unit.

Figure 3.

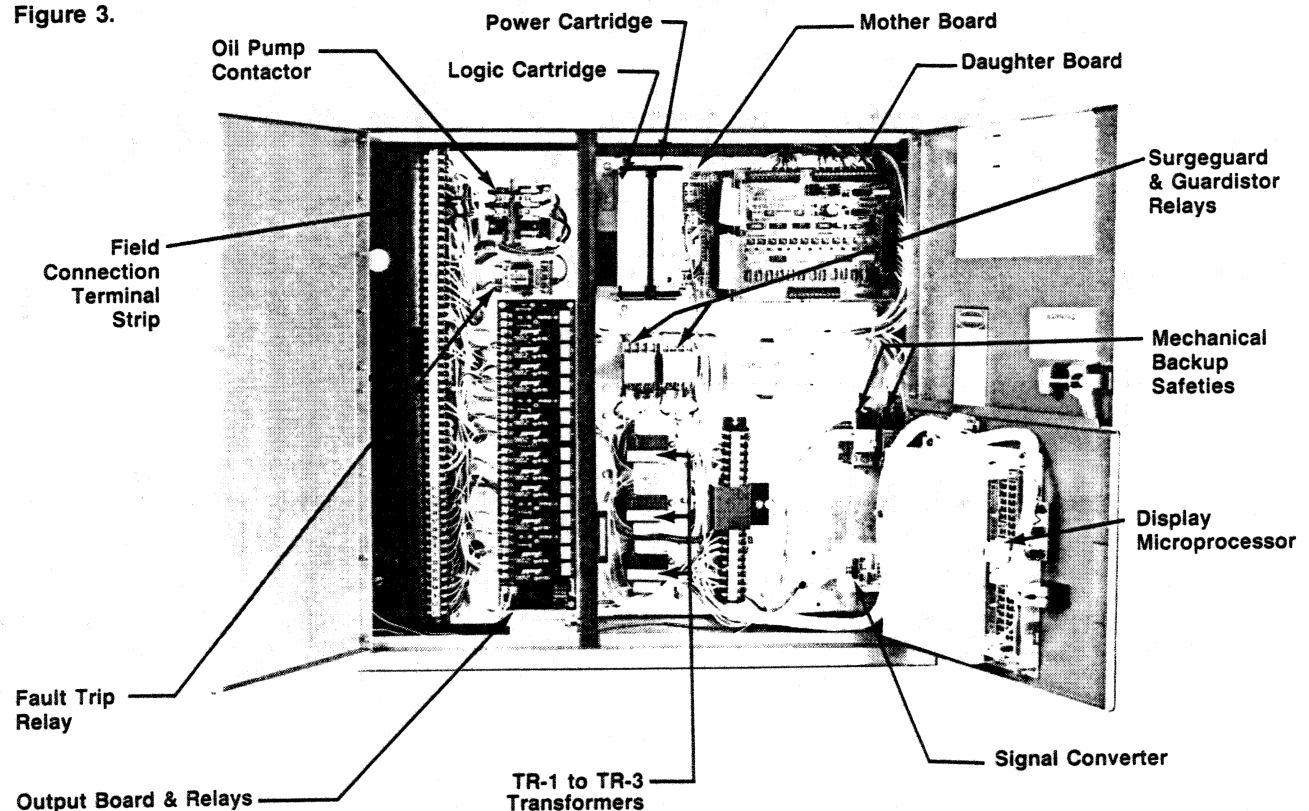

E. Mother Board

The main control processor, or Mother Board, and the two associated control cartridges are housed inside the MicroTech control panel (see Figure 3). The complete Mother Board processor consists of a printed circuit board, a logic cartridge, and a power cartridge. The logic cartridge contains a printed circuit board and

includes the main Microprocessor, program memory, UART drivers (Universal Asynchronous Receiver and Transmitter), output drivers and miscellaneous interconnecting wiring and logic components. The power cartridge contains a DC power supply, voltage protection circuitry, communications driving circuits, and red LED light used for watch-dog microprocessor safety protection between Display processor and Mother Board processor.

F. Daughter Board

The main function of the Daughter Board is input conditioning of all analog inputs received from the analog sensors and digital inputs from control devices. The Daughter Board handles up to 12 digital inputs such as condenser flow or starter transition and handles 14 analog inputs such as "Leaving Evap Water Temp" or "Oil Feed Temp" from temperature thermistors or pressure transducers. The digital inputs are fed through an "opto-isolator" on the Daughter Board that senses the device's reaction (water flow proven) by optically viewing the illuminated LED and passing the proper information onto the main microprocessor for evaluation. The opto-isolators prevent the direct connection of voltage or power to the Mother Board and act as "fuses" to isolate the inputs and condition the incoming signals preventing damage to components.

The digital inputs are received by sensing the presence of a 24 VAC signal at each of the input contacts on TS1 (Terminal Strip 1. See Section III, MicroTech Wiring Schematic). The presence of the 24 VAC at each input is indicated by the dedicated LED's on the Daughter Board. The digital inputs to MicroTech and their associated function are as follows:

DIGITAL INPUT	TERM #	STATUS OR CONDITION
SURGE GUARD	TS1-1	Light ON = OK, Light OFF = SURGE
MOTOR TEMP	TS1-2	Light ON = OK, Light OFF = HIGH TEMP
OIL DIFF PRESSURE	TS1-3	Light ON = OK, Light OFF = LOW PRESS
HIGH DISCHARGE PRES	TS1-4	Light ON = OK, Light OFF = HIGH PRESS
EVAP LOW PRES	TS1-5	Light ON = OK, Light OFF = LOW CHARGE
PANEL STOP/AUTO SLO	TS1-6	Light ON = OK/ON, Light OFF = STOP
STARTER FAULT	TS1-7	Light ON = OK, Light OFF = FAULT
COND WTR FLOW	TS1-8	Light ON = OK, Light OFF = NO FLOW
EVAP WTR FLOW	TS1-9	Light ON = OK, Light OFF = NO FLOW
STARTER TRANS	TS1-10	Light ON = OK, Light OFF = NO TRANS
REMOTE START	TS1-11	Light ON = START, Light OFF = STOP
VANE CLOSED SW	TS1-12	Light ON = CLOSED, Light OFF = OPEN

The 14 analog inputs to the MicroTech are as follows:

SENSOR NO.	SENSOR TYPE	DESCRIPTION	LOCATION
00	Thermistor	Evap LVG Water Temp	TS3-1,2
01	Thermistor	Evap ENT Water Temp	TS3-3,4
02	Thermistor	Evap Sat Refrig Temp	TS3-5,6
03	Thermistor	Comp Suct Temp	TS3-7,8
04	Thermistor	Cond Liq Line Temp	TS3-9,10
05	Thermistor	Cond ENT Water Temp	TS3-11,12
06	Thermistor	Cond LVG Water Temp	TS3-13,14
07	Thermistor	Comp Disch Temp	TS3-15,16
08	Thermistor	Cond Sat Refrig Temp	TS4-1,2
09	Thermistor	Oil Feed Temp	TS4-3,4
10	Thermistor	Oil Sump Temp	TS4-5,6
11	Thermistor	Reset ChW or AMP LIM	TS4-7,8
12	Thermistor	Motor Current	TS4-9,10
13	Press Trans	Oil Gauge Press	TS4-11,12

See Section III for temperature sensor locations.

G. Output Board

The output board contains 115 VAC, 24 VAC and 5 VDC output circuits (digital control) that are managed by the microprocessor. The output is an optically isolated, solid-state gate controlled AC switch (TRIAC) which is in a normally open condition. The following is a summary of the outputs and their associated voltage:

NAME	OUTPUT NO.	VOLTAGE
Unload Solenoid	0	24 VAC
Load Solenoid	1	24 VAC
Hot Gas Solenoid	2	115 VAC
MCR (Starter) Latch Relay	3	115 VAC
Not Used	4	5 VDC
Oil Sump Heater	5	115 VAC
Liquid Injection	6	115 VAC
Remote Alarm Relay	7	24 VAC
Cooling Tower Stage 1	8	115 VAC
Cooling Tower Stage 2	9	115 VAC
Not Used	10	115 VAC
Evaporator Water Pump	11	115 VAC
Condenser Water Pump	12	115 VAC
Oil Pump Contactor	13	115 VAC
Motor Control Relay	14	115 VAC
Not Used	15	5 VDC

H. Display Microprocessor

The Display Microprocessor purpose is to process keyboard input and display processor output via the 20 character display. This processor contains the memory and program for monitoring chiller status and output chiller conditions.

I. Terminal Strip

All wiring to the control panel is done through the main input wiring terminal strip. By requiring all power wiring to be connected only to I/O terminal strip, the possibility of damage to individual terminal strips on each board has been eliminated. Connection between any of the MicroTech boards is done via ribbon cables with socket plugs and/or twisted pairs with plugs. The terminal strip is clearly marked for indication of terminal strip wiring numbers and divided into sections by voltage ratings.

J. Mechanical Back-up

Each MicroTech control system is equipped with mechanical back-up safeties separate from the software control logic safeties in each microprocessor. The backup safeties are High and Low Refrigerant Pressure cutouts and Oil Differential cutout and are used as last resort protection of the chiller system from mechanical breakdowns.

III. MicroTech Wiring Diagrams

A. PEH Field Wiring

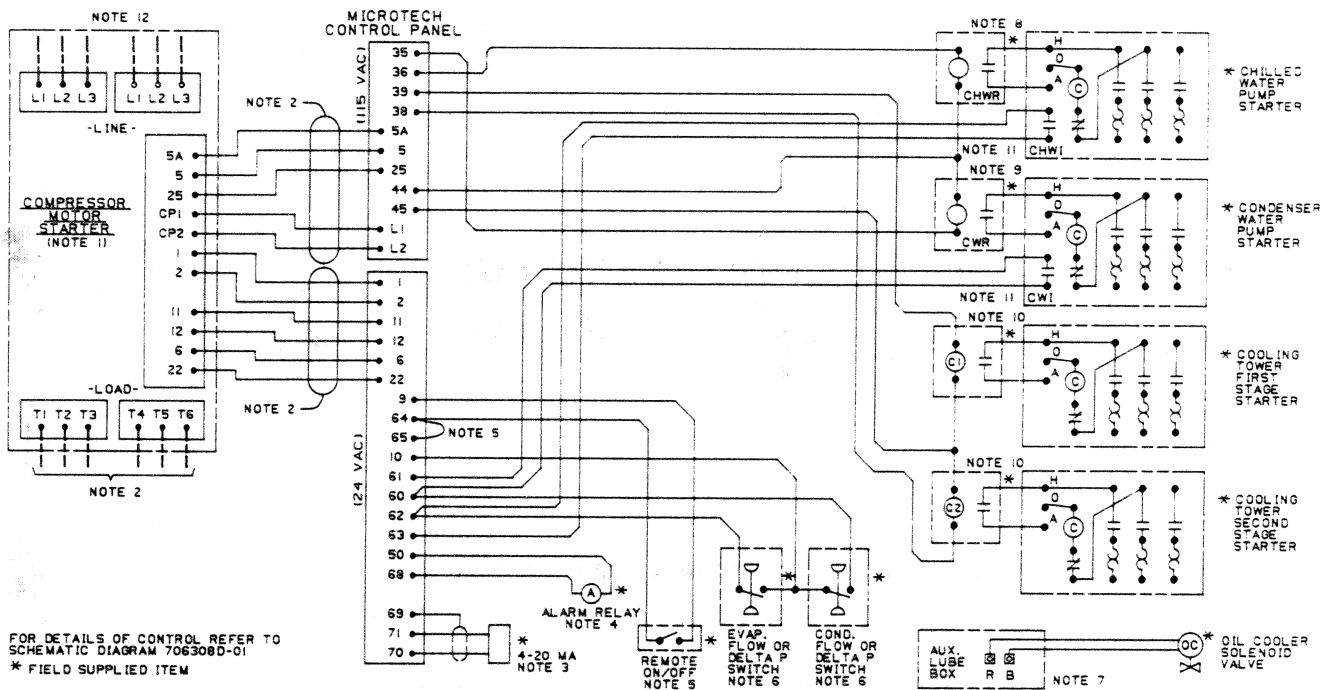

NOTES:

- Compressor motor starters are either factory mounted and wired or shipped separate for field mounting and wiring. If provided by others, starters must comply with McQuay specification 359A999 or 7515A69. All line and load side power conductors must be copper.
- If starters are free standing, then field wiring between the starter and the control panel is required. Minimum wire size for 115V AC is 12 GA. for a maximum length of 50 feet. If greater than 50 feet refer to McQuay for recommended wire size minimum. Wire size for 24 VAC is 18 GA. All wiring to be installed as NEC Class 1 wiring system. All 24 VAC wiring must be run in separate conduit from 115 VAC wiring. Main power wiring between starter and motor terminal is factory installed when units are supplied with unit mounted starters. Wiring of free standing starter must be wired in accordance with NEC and connection to compressor motor terminals must be made with copper wire and copper lugs only.
- Optional reset of chilled water temperature or demand limiting of motor current can be accomplished by wiring 4-20 MA DC signal as shown. It is recommended that DC wires be run separately from 115 VAC wiring.
- An optional customer supplied 24 VAC, 25 VA maximum rated alarm relay can be wired as shown. The circuit will be de-energized if any safety shutdown occurs.
- Remote on/off control of unit can be accomplished by installing a set of dry contacts between terminals 9 and 64. If an additional point of on/off control is required, remove metal jumper J6 from terminals 64 and 65 and install the additional set of dry contacts.
- Evaporator and condenser paddle type flow switches or water pressure differential switches are required and must be wired as shown. If field supplied pressure differential switches are used, then these must be installed across the vessel and not the pump.
- Oil cooler solenoid valve (ASCO Model #8210B27) is required on PEH076 thru 126 models. Refer to the installation manual and wire as shown.
- An optional customer supplied 115 VAC, 25 VA maximum coil rated chilled water pump relay (CHWR) may be wired as shown. This option will cycle the chilled water pump in response to building load.
- The condenser water pump must cycle with the unit. A customer supplied 115 VAC, 25 VA maximum coil rated condenser water pump relay (CWR) is to be wired as shown.
- Optional customer supplied 115 VAC, 25 VA maximum coil rated cooling tower fan relays (C1, C2) may be wired as shown. This option will cycle the cooling tower fans in order to maintain unit head pressure.
- Auxiliary 24 VAC rated contacts in both the chilled water and condenser water pump starters must be wired as shown.
- Incoming power lugs on the McQuay self-manufactured starter are sized for two 4/0 (0000) cables per phase. Six main power leads are required if:
 - The three wire conductor size exceeds 4/0 (0000) — or —
 - The RLA of the compressor exceeds 184 amps.

B. PFH Field Wiring

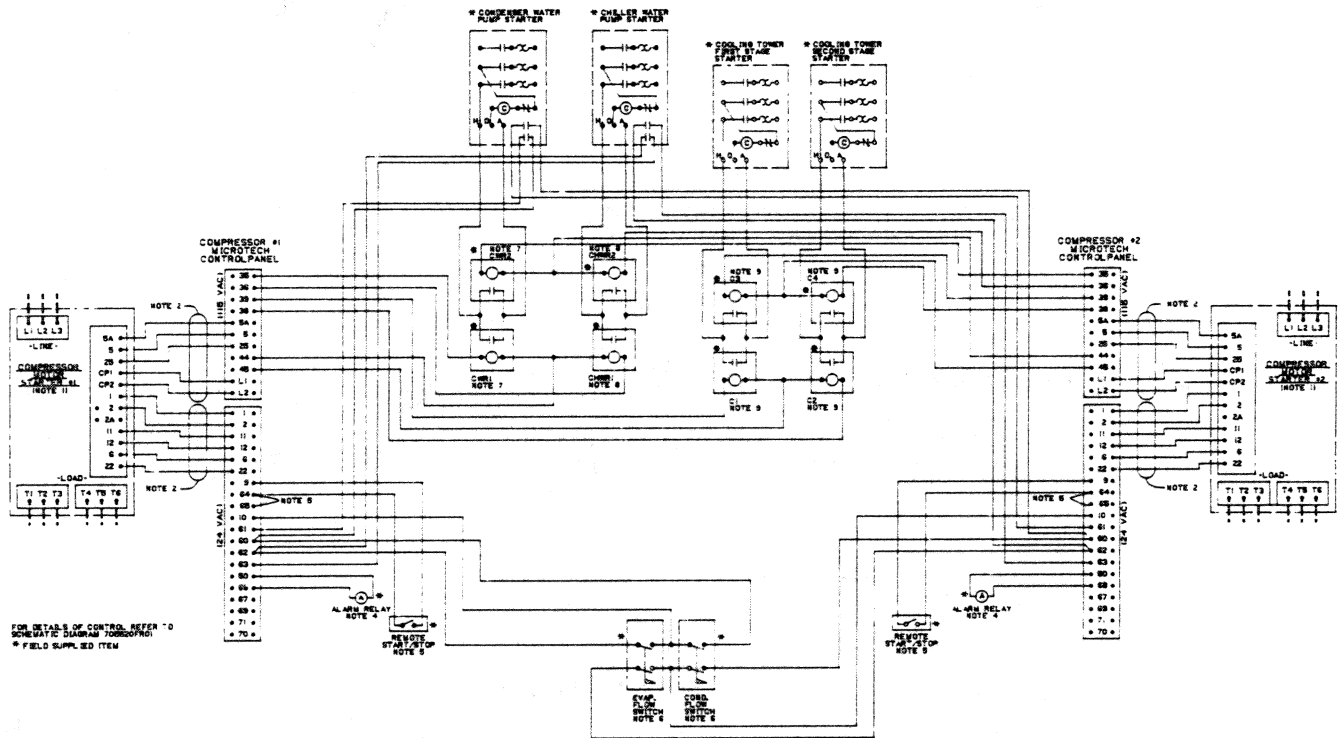

NOTES:

- Compressor motor starters are either factory mounted and wired or shipped separate for field mounting and wiring. If provided by others, starters must comply with McQuay specification 461451Y. All line and load side power conductors must be copper.
- If starters are free standing then field wiring between the starter and the control panel is required. Minimum wire size for 115V AC is 12 GA for a maximum length of 50 feet. If greater than 50 feet refer to McQuay for recommended wire size. Wire size for 24V AC is 18 GA. All wiring to be installed as NEC Class I wiring system. All 24V AC wiring must be run in separate conduit from 115V AC wiring.
- See lead/lag—load/balance panel field wiring diagram (drawing number 552196Y) for connection of demand limit and reset of chilled water signals.
- Optional field supplied 24V AC, 25 VA maximum rated alarm relays can be wired as shown. The circuit will be de-energized if any safety shutdown occurs.
- Remote ON/OFF control of units for multiple unit applications can be accomplished by installing a set of dry contacts between terminals 9 and 64. If an additional point of ON/OFF control is required, remove metal jumper from terminals 64 and 65 and install the additional set of dry contacts between 64 and 65.
- Flow switches are required on evaporator and condenser and shall be DPST as shown. Pressure differential switches may be used in lieu of flow switches but must be DPST type and must be piped across the vessel and not across the pump.
- The condenser water pump(s) must cycle with the unit. Field supplied 115V AC, 25 VA maximum coil rated condenser water pump relays (CWRI and CWR2) must be wired as shown.
- An optional field supplied 115V AC, 25VA maximum coil rated chilled water pump relays (CHWR1 and CHWR2) may be wired as shown. This option will cycle the chilled water pump(s) in response to building load.
- Optional field supplied 115V AC, 25 VA maximum coil rated cooling tower relays (C2, C3 and C4) may be wired as shown. This option will provide 2 stages of tower control based on head pressure.

C. MicroTech Wiring Schematic

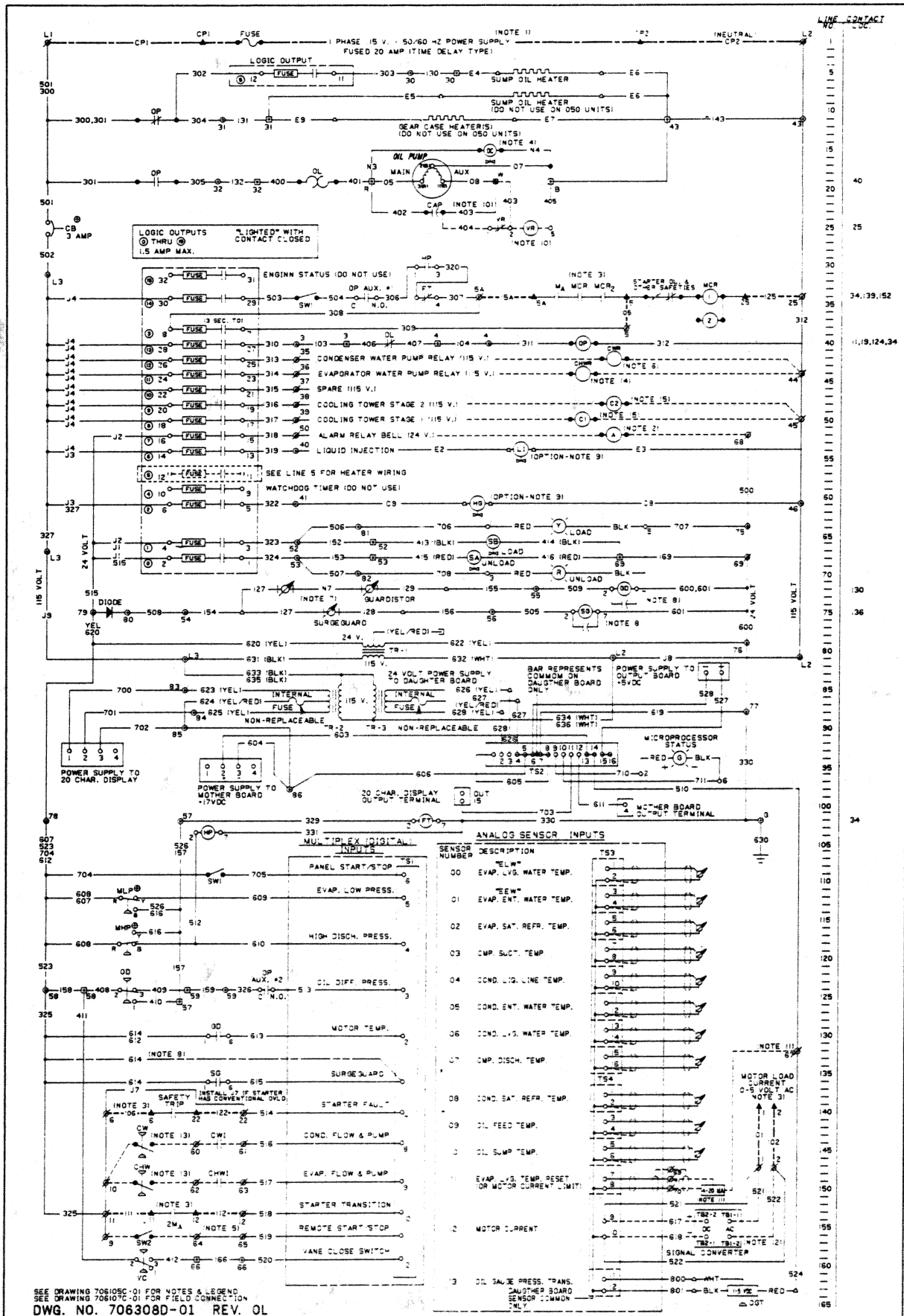

REFER TO NOTES ON NEXT PAGE

E. Sensor Location Diagram

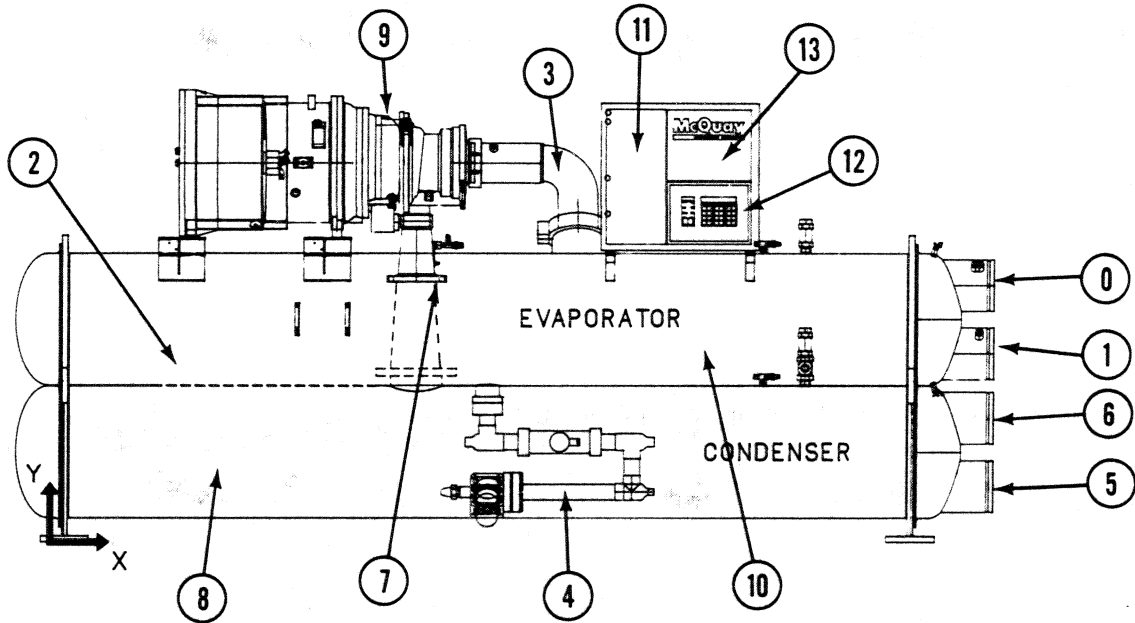

SENSOR DESCRIPTION	SENSOR REF. NO.	TYPE INPUT	TERMINAL STRIP LOCATION	SENSOR LOCATION
Evaporator Leaving Water Temp.	0	Analog	TS3-01/02	Leaving chilled water nozzle on evaporator.
Evaporator Entering Water Temp.	1	Analog	TS3-03/04	Entering chilled water nozzle on evaporator.
Evaporator Saturated Refrig. Temp.	2	Analog	TS3-05/06	Strapped to shell or in well at bottom of evaporator.
Compressor Refrig. Suction Temp.	3	Analog	TS3-07/08	Strapped to, or in well in suction inlet to compressor.
Condenser Liquid Line Temp.	4	Analog	TS3-09/10	Strapped to refrigerant liquid line at condenser outlet.
Condenser Entering Water Temp.	5	Analog	TS3-11/12	At condenser water inlet nozzle.
Condenser Leaving Water Temp.	6	Analog	TS3-13/14	At condenser water outlet nozzle.
Refrigerant Discharge Temp.	7	Analog	TS3-15/16	Strapped to compressor discharge line.
Condenser Saturated Refrig. Temp.	8	Analog	TS4-01/02	Strapped to shell or in well in side of condenser.
Oil Feed Temp.	9	Analog	TS4-03/04	On oil line leaving oil cooler and entering compressor.
Oil Sump Temp.	10	Analog	TS4-05/06	Strapped to, or in well in oil pump below oil level.
Reset-Evap. Lvg. Temp. or Mtr. Amps	11	mA Input	TS4-07/08	4-20 mA input signal from remote, customer supplied source.
Mtr. Current - Capacity Signal	12	DC Volt Signal	TS4-09/10	From 5 VAC or 4 VDC signal converter in unit control panel.
Oil Gauge Pressure	13	Transducer	TS4-11/12	From pressure to electric signal transducer located on back of MicroTech control panel.

IV. Displayed Values and Setpoints

The control panel front consists of one 20 character vacuum fluorescent display, status section with OFF/AUTO system control switch, and key pad input section comprised of 3 function areas: DISPLAY, SETPOINTS, and SERVICE.

20 Character Vacuum Fluorescent Display — The output device from the microprocessor that displays all messages on the control panel front. All outputs display values such as the current ENTERING COND WATER TEMP, all setpoints such as DEMAND LIMIT SET POINT, and all setup options such as TOWER STAGE 1 “ON” CONTROL POINT, are displayed through the display output. Throughout this section of the manual the 20 character vacuum fluorescent display will be referred to as the “display.”

Status Section — Status section displays “watch-dog” status light used between Display Processor and Mother Board Processor (blinking indicates both microprocessors are OK), current condition of compressor and inlet guide vanes (loading, unloading, or holding) and main unit control switch for chiller—OFF/AUTO.

Key Pad Switches — Main input device for operator or service technician to request information from MicroTech. Discrete key pad areas are DISPLAY values (all current operation conditions), SETPOINT values (all control point values), SERVICE values (all safety setpoint, unit configuration and fault history of chiller).

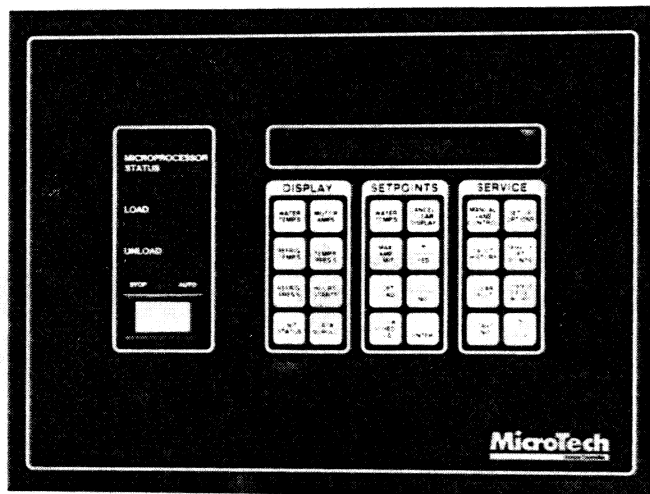

A. Display Values

The entire set of “DISPLAY” keys are used when accessing the current operating conditions of the chiller. None of the display keys are password protected.

In general, to obtain a requested value on the display, press the appropriate button and release. The first value for each key will appear approximately 1 second after releasing. Successive presses of the same key will step through the multiple output feature that each key has and will scroll back to the first displayed value and continue on.

All keys have multiple outputs. Successive key presses will step display through values and return to starting point (scroll to starting point).

NOTE: If at any time should the display be required to be cleared, press “CANCEL, CLEAR DISPLAY” key under the SETPOINTS section. This will clear the current screen information and return the display to an off/blank mode.

The display is designed to indicate requested value(s) for 10 minutes. If there hasn't been activity for more than 10 minutes, the display will “clear” itself and remain blank until further keypad interaction takes place. This has the same effect as pressing “CANCEL, CLEAR DISPLAY” key under the SETPOINTS section.

NOTE: If at any time should “non-standard” output or an unrecognizable code be displayed such as “@!/*%\$” or the MICROPROCESSOR STATUS display light is always “ON” or always “OFF”, rather than blinking, contact your local McQuay Service office for assistance.

DISPLAY KEY 1: "WATER TEMP'S"

1. LEAVING EVAPORATOR WATER TEMPERATURE: To display leaving chilled (evaporator) water temperature press the WATER TEMP'S display key once and release. The following message will appear on the 20 character display:

1ST PRESS: LEAVING EVAP = 42.2 F

Press the "CANCEL, CLEAR DISPLAY" key under SETPOINTS section of key pad to clear display of any value or continue to 2 below for entering evaporator water temperature.

NOTE: Software can display temperatures and pressures in either English or Metric. English values are DEGREES F (Fahrenheit) and PSI (pounds per square inch). Metric values are DEGREES C (Celsius) and kPA (kiloPascal)

The MicroTech control panel has the ability to display all water temperatures to the nearest 0.2 F and accuracy to ± 0.4 F.

2. ENTERING EVAPORATOR WATER TEMPERATURE: To display entering chilled (evaporator) water temperature press the WATER TEMP'S display key two (2) successive times and release. The following message will appear on the 20 character display:

1ST PRESS: LEAVING EVAP = 42.2 F

2ND PRESS: ENTERING EVAP = 54.0 F

3. ENTERING CONDENSER WATER TEMPERATURE: To display entering condenser water temperature press the WATER TEMP'S display key three (3) successive times and release. The following message will appear on the 20 character display:

1ST PRESS: LEAVING EVAP = 42.2 F

2ND PRESS: ENTERING EVAP = 54.0 F

3RD PRESS: ENTERING COND = 81.4 F

4. LEAVING CONDENSER WATER TEMPERATURE: To display leaving condenser water temperature, press the WATER TEMP'S display key four (4) successive times and release. The following message will appear on the 20 character display:

1ST PRESS: LEAVING EVAP = 42.2 F

2ND PRESS: ENTERING EVAP = 54.0 F

3RD PRESS: ENTERING COND = 81.4 F

4TH PRESS: LEAVING COND = 90.8 F

Pressing the "WATER TEMP'S" key and additional time will return you to the first display showing the EVAP LEAVING WATER TEMP.

DISPLAY KEY 2: "REFRIG TEMP'S"

1. EVAPORATOR TEMPERATURE: To display the evaporator refrigerant temperature press the REFRIG TEMP'S display key once (1) and release. The following message will appear on the display:

1ST PRESS: EVAPORATOR = 40.2 F

Press the "CANCEL, CLEAR DISPLAY" key under SETPOINTS section of key pad to clear display of any value or continue to 2 below for suction line temperature.

2. **SUCTION LINE TEMPERATURE:** To display the suction line temperature press the REFRIG TEMP'S display key twice (2) and release. The following message will appear on the display:

1ST PRESS: EVAPORATOR = 40.2 F

2ND PRESS: SUCTION LINE = 41.4 F

3. **REFRIGERANT SUPERHEAT:** To display the refrigerant SUPERHEAT temperature (Superheat equals Suction Line Temperature minus Evaporator Temperature), press the REFRIG TEMP'S display key three (3) times and release. The following message will appear on the display:

1ST PRESS: EVAPORATOR = 40.2 F

2ND PRESS: SUCTION LINE = 41.4 F

3RD PRESS: SUPERHEAT = 1.2 F

4. **DISCHARGE REFRIGERANT TEMPERATURE:** To display the refrigerant DISCHARGE temperature, press the REFRIG TEMP'S display key four (4) times and release. The following message will appear on the display after pressing the key the fourth time:

4TH PRESS: DISCHARGE = 115 F

5. **CONDENSER REFRIGERANT TEMPERATURE:** To display the condenser refrigerant temperature, press the REFRIG TEMP'S display key five (5) times and release. The following will appear on the display:

5TH PRESS: CONDENSER = 95 F

6. **LIQUID LINE REFRIGERANT TEMPERATURE:** To display the liquid line refrigerant temperature, press the REFRIG TEMP'S display key six (6) times and release. The following will appear on the display:

6TH PRESS: LIQUID LINE = 79.8 F

7. **LIQUID SUBCOOLING:** To display the amount of liquid refrigerant subcooling (in degrees) [liquid subcooling = condenser temperature minus liquid line temperature], press the REFRIG TEMP'S display key seven (7) times and release. The following will appear on the display:

7TH PRESS: LIQ SUBCOOL = 15.2 F

8. **CONDENSER TEMPERATURE APPROACH:** To display the condenser approach (condenser temperature minus leaving condenser water temperature) press the REFRIG TEMP'S display key eight (8) times and release. The following will appear on the display:

8TH PRESS: COND APPROACH = 4.2 F

Pressing the "REFRIG TEMP'S" key an additional time will return you to the first display showing the EVAPORATOR TEMPERATURE.

DISPLAY KEY 3: "REFRIG. PRES'S"

1. **EVAPORATOR PRESSURE:** To display the evaporator pressure press the REFRIG PRES'S display key once (1) and release. The following message will appear on the display:

1ST PRESS: EVAP PRESSURE = 37 PSI

Press the "CANCEL, CLEAR DISPLAY" key under SETPOINTS section of key pad to clear display of any value or continue to #2 (below) for condenser pressure.

2. CONDENSER PRESSURE: To display the condenser pressure press the REFRIG PRES'S display key twice (2) and release. The following message will appear on the display:

2ND PRESS: COND PRESSURE = 108 PSI

3. LIFT PRESSURE: To display the lift or head pressure (condenser pressure minus evaporator pressure in PSI differential) press the REFRIG PRES'S display key three (3) times and release. The following message will appear on the display:

3RD PRESS: LIFT PRESSURE = 71 PSID

DISPLAY KEY 4: "UNIT STATUS"

1. By pressing the "UNIT STATUS" button once, the MicroTech control panel will display its current operating condition. This could indicate that the unit is OFF and is waiting for system load, or that the unit is currently in a startup mode and will be starting in XX minutes. The following is a partial list of some of the possible display outputs that can occur:

- a. When the "UNIT STATUS" key is pressed during a startup sequence, the following can be displayed:

- 1) "WILL START IN XX MIN" — This display will be shown when any of the anti-recycle timers have not been satisfied (Start-to-Start timer or Stop-to-Start timer), or if the unit is in the very first moments of startup sequence.
- 2) "EVAP PUMP IS ON XX" (XX indicates seconds) — Display indicates that the startup sequence has started and the evaporator pump is ON. The timer is set to run the evaporator pump for 15 seconds prior to starting in order to determine if there is adequate system load present. See Load Delay Timer, Section VI-E.
- 3) "WAITING FOR LOAD " — After running the evaporator pump (#2 above) and sensing the leaving water temperature, it was determined that the water temperature was not above the startup setpoint (not enough load) and therefore unit was not started.
- 4) "OIL PUMP IS ON XX" (XX indicates seconds) — The oil pump is ON and will run for XX (timer is counting down from 30 second mark) more seconds before starting the condenser pump or compressor. The oil pump will run for 30 seconds prior to compressor start in order to prelubricate bearings and close the inlet guide vanes.
- 5) "COND PUMP IS ON XX" (XX indicates seconds) — Prior to the compressor starting, the condenser water pump will operate for 5 seconds in order to prove condenser water flow and pump operation. Timer is counting down from 5 seconds.
- 6) "MCR IS ON XX" (XX indicates seconds) — This indicates that the starter has been given the required signals to proceed through its starting sequence, and is timing down before proceeding to normal unit operation. (MCR is Motor Control Relay.)
- 7) "UNIT IS RUNNING OK" — All systems are operating in proper order, unit is under its own automatic control (leaving chilled water), and all setpoints and safeties are being monitored.

- b. When the "UNIT STATUS" key is pressed during a shutdown sequence, the following can be displayed:

- 1) "STOP, UNLOADING XX" (XX indicates seconds) — During the shutdown sequence (non-safety shutdown) the MicroTech control panel will first close the inlet guide vanes before stopping the compressor. This timed shutdown is 30 seconds plus Post-Lube Timer.
- 2) "MCR OFF, POST-LUBE XX" (XX indicates seconds) — At this point in the shutdown, the compressor will stop (MCR OFF: Motor Control Relay OFF) and the oil pump will continue to operate for an additional 30 seconds for post-lube and compressor countdown (XX is the countdown in seconds remaining).

- c. When the "UNIT STATUS" key is pressed while the unit is off or not operating, one of the following can be displayed:

- 1) "WAITING, HIGH AMPS XX" — When this display appears, the compressor is not operating, but the oil pump is still running. This happens when the control system still sees some current being drawn by the unit. MicroTech will operate the oil pump whenever amps are being drawn and the compressor is OFF.

- 2) "OFF: LOAD RECYCLE" — This indicates the unit is not running because it has satisfied the system load. When the chilled water loop temperature has risen enough, the unit will start automatically. If, for example, the unit's chilled water temperature setpoint were 44.0 F, the unit will cycle off (load recycle) when a leaving chilled water temperature of 41.0 is reached (shutdown temperature difference and startup temperature is factory set for 3 degrees F and is field adjustable). With the unit off and the evaporator pump in operation, the unit will automatically come back on line when the leaving evaporator water temp reaches 47.0 F.
 - 3) "OFF: TIME SCHEDULE" — "TIME SCHEDULE" indicates that the unit is OFF because the current unit time falls within a scheduled OFF time period. See Section IV-B or VI-D.
 - 4) "OFF: REMOTE SIGNAL" — The unit is off due to a remote ON/OFF control signal.
 - 5) "OFF: MANUAL SWITCH" — The manual STOP/AUTO switch on the panel front is in the STOP position. This must be in the AUTO position in order for the unit to operate.
 - 6) "OFF: READY TO START" — All systems are in proper operating condition (unit OFF) and the unit will start when the proper load is established.
2. By pressing the "UNIT STATUS" button a second time, (pressing the "UNIT STATUS" button 2 through 8 times will display current system control parameters 2 through 8 listed here and below), the following message will be displayed:

2ND PRESS OF "UNIT STATUS":

ENT WTR RESET = OFF

This indicates that the "entering water reset" or "reset from return water" feature is not currently being used. When the display indicates ON, the unit is resetting the leaving chilled water temperature based on the entering evaporator water temperature. See the "SET-UP OPTIONS" key under Service section for a complete explanation.

3. Pressing "UNIT STATUS" a third time, the following will be displayed:

3RD PRESS OF "UNIT STATUS":

REMOTE RESET = OFF

This indicates that "RESET FROM REMOTE SIGNAL" is not being used at the present time. When "REMOTE RESET = ON", the leaving chilled water temperature can be reset from an external 4-20mA signal from an EMS (Energy Management System) signal. See the "SET-UP OPTIONS" key under Service section for a complete explanation.

4. Pressing "UNIT STATUS" a fourth time, the following will be displayed:

4TH PRESS OF "UNIT STATUS":

SOFT LOADING = OFF

This indicates that the "SOFT LOADING" feature is OFF or is operating when ACTIVE is displayed. Whenever "SOFT LOADING = ACTIVE", the unit is limiting the compressor from loading further (limiting the inlet guide vanes to open further) due to the "SOFT LOADING" schedule. See "SOFT LOAD" key under Setpoints section for a complete explanation.

5. Pressing "UNIT STATUS" a fifth time, the following will be displayed:

5TH PRESS OF "UNIT STATUS":

LOW PRES UNLD = OFF

This indicates that the unit is not being unloaded due to low evaporator temperature or pressure. If the evaporator temperature should drop below 33.0 F, the unit will first attempt to unload the compressor (ACTIVATE low pressure override) in order to elevate this condition. Should the evaporator temperature continue decrease below 32.0 F, the unit will be shut down by low evaporator temperature safety. See the "SET-UP OPTIONS" key under Service section for a complete explanation.

6. Pressing "UNIT STATUS" a sixth time, the following will be displayed:

6TH PRESS OF "UNIT STATUS":

MAX AMP LIMIT= OFF

"MAX AMP LIMIT= OFF" indicates the unit is not being amp limited at its full load or 100% RLA point. Should the unit load beyond 100% RLA, MAX AMP LIMIT will be ON and the MicroTech will command the unit to unload (close inlet guide vanes) and decrease its amp draw until the RLA is at 100% or less.

7. Pressing "UNIT STATUS" a seventh time, the following will be displayed:

7TH PRESS of "UNIT STATUS": REMOT AMP LIM= OFF

This indicates that the unit is not being limited from a remote 4-20mA EMS signal. When "REMOTE AMP LIM = ACTIVE" is indicated, the unit is being limited from the remote signal. See the "MAX AMP LIMIT" key under Setpoints and "SET-UP OPTIONS" key under Service for a complete explanation.

8. Pressing "UNIT STATUS" an eighth time, the following will be displayed:

8TH PRESS of "UNIT STATUS": MAN'L AMP LIM= OFF

This indicates that the unit is not being limited by the MicroTech's local (at control panel) amp limiting feature. When "MAN'L AMP LIM = ACTIVE" is indicated, the unit is being amp limited by the MicroTech control panel. See the "MAX AMP LIMIT" key under Setpoints for a complete explanation.

DISPLAY KEY 5: "MOTOR AMPS"

1. By pressing the "MOTOR AMPS" button once, the following will be displayed:

1ST PRESS of "MOTOR AMPS": MOTOR AMPS = 120 A

This is the average amps being drawn by the unit.

2. Pressing "MOTOR AMPS" a second time, the following will be displayed:

2ND PRESS of "MOTOR AMPS": MOTOR % RLA = 72%

This is the percent of full load RLA that the unit is currently drawing.

DISPLAY KEY 6: "OIL TEMP'S, PRES'S"

1. By pressing the "OIL TEMP'S, PRES'S" button once, the following will be displayed:

1ST PRESS of "OIL TEMP'S, PRES'S": OIL FEED TEMP= 130 F

This is the temperature of the oil being supplied to the compressor.

2. Pressing "OIL TEMP'S, PRES'S" a second time, the following will be displayed:

2ND PRESS of "OIL TEMP'S, PRES'S": OIL SUMP TEMP= 140 F

This is the temperature of the oil in the oil sump or reservoir.

3. Pressing "OIL TEMP'S, PRES'S" a third time, the following will be displayed:

3RD PRESS of "OIL TEMP'S, PRES'S": OIL GAUGE PRES = 150 PSI

This is the supply pressure of the oil at the compressor.

4. Pressing "OIL TEMP'S, PRES'S" a fourth time, the following will be displayed:

4TH PRESS of "OIL TEMP'S, PRES'S": OIL DIF PRES = 100 PSI

This is the difference between the oil supply pressure and the oil pressure returning from the compressor.

DISPLAY KEY 7: "HOURS, STARTS"

1. By pressing the "HOURS, STARTS" button once, the following will be displayed:

1ST PRESS of "HOURS, STARTS": OPERATING HRS = 2566

This is the total elapsed time on the unit. The microprocessor will store total hours without any type of battery backup, even when the unit has been disconnected from line power or from a power failure.

2. Pressing "HOURS, STARTS" a second time, the following will be displayed:

2ND PRESS of "HOURS, STARTS":

NO. OF STARTS = 25

This is the total number of starts the machine has had. The microprocessor will store total number of starts without any type of battery backup, even when the unit has been disconnected from line power or from power failure.

3. Pressing "HOURS, STARTS" a third time, the following will be displayed:

3RD PRESS of "HOURS, STARTS":

START HRS AGO = 4.2

"START HRS AGO" indicates the elapsed time since the unit last started. The value indicates the amount of time the unit has been operating during the current run period. The maximum elapsed time that can be displayed is 128 hours.

DISPLAY KEY 8: "DATA SCROLL"

1. By pressing "DATA SCROLL", the display will step (scroll) through all of preceding DISPLAY values, all setpoints, and complete fault history with each description and parameter being displayed for approximately 4 seconds. The following is a list of the complete output:

- | | |
|------------------------------|---------------------------|
| 1. UNIT IS RUNNING OK | 28. REMOTE RESET = OFF |
| 2. LEAVING EVAP = 44.2 F | 29. SOFT LOADING = OFF |
| 3. ENTERING EVAP = 54.2 F | 30. LOW PRES UNLD = OFF |
| 4. ENTERING COND = 85.2 F | 31. MAX AMP LIMIT = OFF |
| 5. LEAVING COND = 95.2 F | 32. REM AMP LIMIT = OFF |
| 6. EVAPORATOR = 40.4 F | 33. MAN'L AMP LIM = OFF |
| 7. SUCTION LINE = 42.4 F | 34. UNIT IS RUNNING OK |
| 8. SUPERHEAT = 2.0 F | 35. LVG EVAP SPT = 44.0 F |
| 9. DISCHARGE = 115 F | 36. RESET LVG SPT = N/A |
| 10. CONDENSER = 98 F | 37. REM RESET SIG = N/A |
| 11. LIQUID LINE = 87.2 F | 38. MAX AMP LIM = 100% |
| 12. LIQ SUBCOOL = 10.8 F | 39. REMOT AMP LIM = N/A |
| 13. COND APPROACH = 3.0 F | 40. REMOT AMP SIG = N/A |
| 14. EVAP PRESSURE = 37 PSI | 41. SOFT LOAD LIM = 100% |
| 15. COND PRESSURE = 114 PSI | 42. BEGIN AMP LIM = 40% |
| 16. LIFT PRESSURE = 77 PSID | 43. RAMP UP TIME = 60 MIN |
| 17. MOTOR % RLA = 54% | 44. NOW = NO FAULT |
| 18. MOTOR AMPS = 127 | 45. LAST = NO FAULT |
| 19. OIL FEED TEMP = 130 F | 46. 2ND = NO FAULT |
| 20. OIL SUMP TEMP = 140 F | 47. 3RD = NO FAULT |
| 21. OIL GAUGE PRES = 155 PSI | 48. 4TH = NO FAULT |
| 22. OIL DIF PRES = 118 PSI | 49. 5TH = NO FAULT |
| 23. OPERATING HRS = 2125 | 50. 6TH = NO FAULT |
| 24. NO. OF STARTS = 123 | 51. 7TH = NO FAULT |
| 25. START HRS AGO = 12.5 | 52. 8TH = NO FAULT |
| 26. UNIT IS RUNNING OK | 53. UNIT IS RUNNING OK |
| 27. ENT WTR RESET = OFF | |

B. Setpoints

Setpoint keys are designed to allow access to any of the current setpoint values and allow changes and alterations with the proper authorization password. The SETPOINT keys are protected from unauthorized access by a four-digit keypress combination password. This level of password is called "OPERATORS" password. Access to any of the SETPOINTS can also be accomplished by using the SERVICE password.

To enter the password, the following sequence is required:

1. Press any of the SETPOINT keys to be changed (i.e., "WATER TEMP'S", "MAX. AMP LIMIT", "SOFT

- LOAD", or "CLOCK, SCHEDULE") until requested setpoint is displayed.
2. Press the "+/YES" or "-/NO" key.
3. The following message will be displayed: "ENTER PASSWORD".
4. Enter the OPERATOR or SERVICE password.
5. One of the following will be displayed: "OPERATOR PASSWORD OK" or "SERVICE PASSWORD OK".
6. Press SETPOINTS key until desired option is displayed.
7. Use the "+/YES" or "-/NO" keys to modify parameter. The original setpoint will change to a different value that will be displayed in a blinking manner. Step 8 must be completed in order for value to be retained. If the new value was incorrect or not wanted, press "CANCEL, CLEAR DISPLAY" to erase.
8. Use "=/ENTER" key to enter change into the memory of the MicroTech processor. The value will not be placed in memory acted upon until the "=/ENTER" key is pressed.

NOTE: Once a password is entered, the microprocessor starts a ten minute countdown. During the next ten minutes, the operator is authorized to make other parameter changes without re-entering the password. Each time a parameter is changed, the password timer is reset to 10 minutes.

By pressing the "CANCEL, CLEAR DISPLAY" the password timer is set down to 1 minute and password authorization will expire in one minute. This procedure is recommended when leaving the area in order to eliminate the possibility of unauthorized access while unattended.

SETPOINT KEY 1: "WATER TEMP'S"

1. LEAVING EVAPORATOR WATER TEMPERATURE SETPOINT: To display the current leaving chilled (evaporator) water setpoint temperature, press the WATER TEMP'S setpoint key once and release. The following message will appear on the 20 character display:

1ST PRESS: LVG EVAP SPT = 44.0 F

To change the Leaving Evaporator setpoint, press the "+/YES" or "-/NO" keys until the new value is displayed and then press the "=/ENTER" key to enter change into memory. See Section VI for programming the MicroTech.

Press the "CANCEL, CLEAR DISPLAY" key under SETPOINTS section of key pad to clear display if change was not wanted.

2. RESET OF LEAVING CHILLER WATER METHOD: To display the current method of reset, press the WATER TEMP'S setpoint key twice and release. The following message will appear on the 20 character display:

2ND PRESS RESET LVG SPT = N/A

If the RESET OPTION is programmed to either CHW or ENT under the SERVICE key "SET-UP OPTIONS", the N/A's are replaced with actual method.

IF THE RESET OPTION IS CHW: RESET LVG SPT is the leaving chiller water setpoint which is calculated based upon a 4-20 mA DC signal. The amount of reset is based on the following schedule.

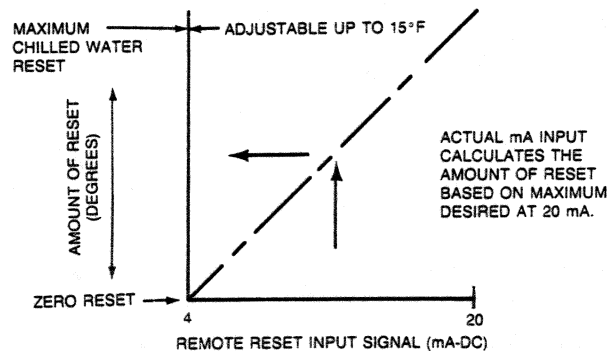

IF THE RESET OPTION IS ENT: If RESET LVG SPT is the ENT (entering), the leaving chilled water setpoint is calculated to maintain a constant entering chilled water temperature.

3. **REMOTE RESET SIGNAL:** To display the current amount of reset when RESET OPTION is ChW, press the WATER TEMP'S setpoint key three times and release. The following message will appear on the display:

3RD PRESS: RMT RESET SIG = 10.0

If the RESET OPTION is programmed to ChW under the SERVICE key "SET-UP OPTIONS", the current signal being input to the MicroTech is displayed. See #2 above for calculation of reset amount.

SETPOINT KEY 2: "MAX. AMP LIMIT"

1. **MAXIMUM AMP LIMIT SETPOINT:** To display the current demand amp limit setpoint, press the "MAX AMP LIMIT" setpoint key once and release. The following message will appear on the display:

1ST PRESS: MAX AMP LIM = 100%

This is the maximum % RLA that the unit will be allowed to load to. Operation of the unit above this value will not be allowed and the compressor will not load further.

To change the MAX AMP LIMIT setpoint (with password already entered), press the "+ /YES" or "- /NO" keys until the new value is displayed and then press the "= /ENTER" key to enter change into memory.

Press the "CANCEL, CLEAR DISPLAY" key under SETPOINTS section of key pad to clear display if change was not wanted.

2. **REMOTE AMP LIMIT:** To display the current remote demand limit setpoint, press the MAX AMP LIMIT setpoint key twice and release. The following message will appear on the display:

2ND PRESS: REMOTE AMP LIM = N/A

If the RESET OPTION is programmed to AMP under the SERVICE key "SET-UP OPTIONS", the N/A's are replaced with actual method.

If the RESET OPTION is AMP: REMOT AMP LIM is ON, the amount of demand limit is calculated based upon a 4-20 mA DC input signal. The amount of amp limiting is based on the following schedule:

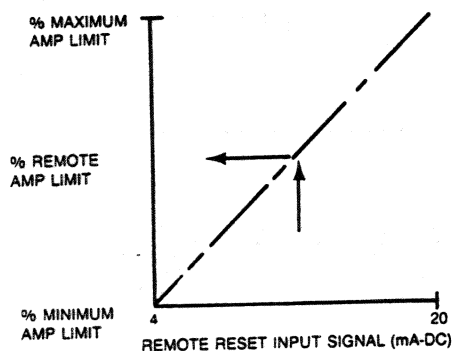

3. **REMOTE RESET SIGNAL:** To display the value of the current input signal (RESET OPTION = AMP), press the MAX AMP LIMIT setpoint key three times and release. The following message will appear on the display:

3RD PRESS: REMOT AMP SIG = 10.0

If the RESET OPTION is programmed to AMP under the SERVICE key "SET-UP OPTIONS", the current signal being input to the MicroTech panel is displayed. See #2 above for calculation of the demand limit.

SETPOINT KEY 3: "SOFT LOAD"

1. **SOFT LOAD LIMIT:** Soft or ramp loading is the gradual increase in capacity of the compressor over time to eliminate over loading during startup and prevent the chiller from radical loading and

unloading. To ramp load a chiller, two items must be provided: initial load point and time to full load.

The initial load point is expressed in % RLA and is the point the chiller will load to when first coming on line (see #2 below). The time factor (see #3 below) is used to slowly load the compressor over time at an increasing rate until full load or the existing system capacity is reached.

To display the current point that the chiller is being load limited to, press the "SOFT LOAD" setpoint key once and release. The following message will appear on the display:

1ST PRESS: SOFT LOAD LIM = 50%

This is the maximum % RLA that the unit is being allowed to load to because of the ramp up loading and as time elapses, the % value will increase in the following straight line relationship:

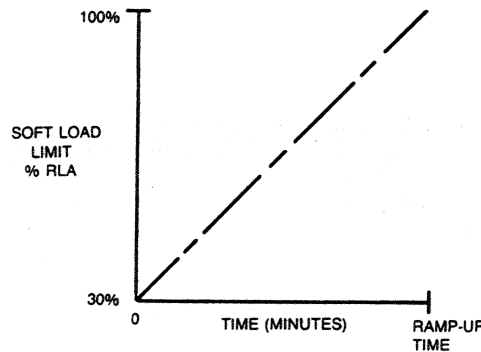

2. **BEGINNING AMP LIMIT POINT DURING SOFT LOADING:** To display the current initial load point during soft loading, press the SOFT LOAD setpoint key twice and release. The following message will appear on the display:

2ND PRESS: BEG AMP LIMIT = 40%

This is the initial load point the chiller will load to when it first starts. To change this value, press the "+ /YES" or "- /NO" keys until the new value is displayed and then press the "= /ENTER" key enter change into memory.

3. **REMOTE RESET SIGNAL:** To display the current loading time during a soft load, press the SOFT LOAD setpoint key three times and release. The following message will appear on the display:

3RD PRESS: RAMP UP TIME = 60

This is the time (minutes) the chiller will take to load from its initial load point (#2 above) to full capacity. To change this value, press the "+ /YES" or "- /NO" keys until the new value is displayed and then press the "= /ENTER" key to enter change into memory.

SETPOINT KEY 4: "CLOCK, SCHEDULE"

1. **CURRENT TIME:** To display the current time, press "CLOCK, SCHEDULE" key once and release. The following message will appear on the display:

1ST PRESS: CURRENT TIME = 13:51

All MicroTech control panels have a lithium powered timeclock. Note that the time is given in military time; all clock functions are based on 24:00 hours per day, thus eliminating AM/PM problems.

2. **OVERRIDE HOURS:** If the timeclock schedules dictated the unit to be in an inoperative mode or it happened to be an OFF cycled holiday, the unit could be started without changing any of the time schedules by instructing the chiller to override "OFF" functions and operate for a given length of time (hours). In order to add "OVERRIDE" hours (with password entered), press the "+ /YES" keys to add time until the required time is displayed and then press the "= /ENTER" key to enter change into memory.

The following message would appear on the display:

2ND PRESS:

OVERRIDE (HRS) = 5.2

The unit will now operate for 5.2 hours (ignoring time schedules) after "START UNIT" key under Service section has been pressed.

3. HOUR NOW: To display the current hour of the timeclock, press "CLOCK, SCHEDULE" three times and release. The following message will appear on the display:

3RD PRESS:

HOUR NOW, 0-23 = 13

As mentioned above, all times are based on 24 hour military time. In order to change the current "HOUR NOW" (with password entered), press the "+/YES" or "-/NO" keys until the new value is displayed and then press the "=/ENTER" key to enter change into memory.

4. MINUTES: To display the current minutes of the timeclock, press "CLOCK, SCHEDULE" four times and release. The following message will appear on the display:

4TH PRESS:

MINUTES, 0-59 = 51

In order to change the current "MINUTES" (with password entered), press the "+/YES" or "-/NO" keys until the new value is displayed and then press the "=/ENTER" key to enter change into memory.

5. SECONDS: To display the current seconds of the timeclock, press "CLOCK, SCHEDULE" five times and release. The following message will appear on the display:

5TH PRESS:

SECONDS, 0-59 = 12

In order to change the current "SECONDS" (with password entered), press the "+/YES" or "-/NO" keys until the new value is displayed and then press the "=/ENTER" key to enter change into memory.

6. DAY OF THE WEEK: To display the current day, press "CLOCK, SCHEDULE" six times and release. The following message will appear on the display:

6TH PRESS:

DAY OF WEEK = SAT

In order to change the current "DAY" (with password entered), press the "+/YES" or "-/NO" keys until the new value is displayed and then press the "=/ENTER" key to enter change into memory.

7. MONTH: To display the current month, press "CLOCK, SCHEDULE" seven times and release. The following message will appear on the display:

7TH PRESS:

MONTH, 1-12 = 10

In order to change the current "MONTH" (with password entered), press the "+/YES" or "-/NO" keys until the new value is displayed and then press the "=/ENTER" key to enter change into memory.

8. DATE: To display the current date, press "CLOCK, SCHEDULE" eight times and release. The following message will appear on the display:

8TH PRESS:

DATE, 1-31 = 14

In order to change the current "DATE" (with password entered), press the "+/YES" or "-/NO" keys until the new value is displayed and then press the "=/ENTER" key to enter change into memory.

9. YEAR: To display the current year, press "CLOCK, SCHEDULE" nine times and release. The following message will appear on the display:

9TH PRESS:

YEAR, 0-99 = 88

In order to change the current "YEAR" (with password entered), press the "+/YES" or "-/NO" keys until the new value is displayed and then press the "=/ENTER" key to enter change into memory.

10. SCHEDULE 1: S1 FIRST DAY: The MicroTech schedule functions are designed on two different repeating ON/OFF cycles. The first schedule (S1) can be setup to operate for 1 to 7 consecutive days and START/STOP the unit at any hour and minute of a given day. The second schedule (S2) can be used in the same manner to complement the first. See Section VI-D for programming.

To display the start day for schedule 1 (S1), press "CLOCK, SCHEDULE" ten times and release. The following message will appear on the display:

10TH PRESS: S1 FIRST DAY = OFF

In order to change the current "S1 FIRST DAY" (with password entered), press the "+/YES" or "-/NO" keys until the new value is displayed and then press the "=/ENTER" key to enter change into memory.

To disable the schedule feature completely (S1 and S2 allow machine operation at any time), set the S1 FIRST DAY to OFF. This will then instruct MicroTech to ignore the rest of the SCHEDULE features.

11. SCHEDULE 1: S1 LAST DAY — To display the last day for Schedule 1, press "CLOCK, SCHEDULE" eleven times and release. The following message will appear on the display:

11TH PRESS: S1 LAST DAY = FRI

In order to change the current "S1 LAST DAY" (with password entered), press the "+/YES" or "-/NO" keys until the new value is displayed and then press the "=/ENTER" key to enter change into memory.

12. SCHEDULE 1: START HOUR — To display the starting hour for Schedule 1, press "CLOCK, SCHEDULE" twelve times and release. The following message will appear on the display:

12TH PRESS: S1 START HOUR = 7

To change the current "S1 START HOUR" (with password entered), press the "+/YES" or "-/NO" keys until the new value is displayed and then press the "=/ENTER" key to enter change into memory.

13. SCHEDULE 1: START MINUTE — To display the starting minute for Schedule 1, press "CLOCK, SCHEDULE" thirteen times and release. The following message will appear on the display:

13TH PRESS: S1 START MIN = 15

To change the current "S1 START MIN" (with password entered), press the "+/YES" or "-/NO" keys until the new value is displayed and then press the "=/ENTER" key to enter change into memory.

14. SCHEDULE 1: STOP HOUR — To display the stopping hour for Schedule 1, press "CLOCK, SCHEDULE" fourteen times and release. The following message will appear on the display:

14TH PRESS: S1 STOP HOUR = 17

To change the current "S1 STOP HOUR" (with password entered), press the "+/YES" or "-/NO" keys until the new value is displayed and then press the "=/ENTER" key to enter change into memory.

15. SCHEDULE 1: STOP MINUTE — To display the stopping minute for Schedule 1, press "CLOCK, SCHEDULE" fifteen times and release. The following message will appear on the display:

15TH PRESS S1 STOP MIN = 45

To change the current "S1 STOP MIN" (with password entered), press the "+/YES" or "-/NO" keys until the new value is displayed and then press the "=/ENTER" key to enter change into memory.

16. —21. SCHEDULE 2 — To change or alter the second schedule (S2), follow the same procedure outlined above in 10 through 16 for Schedule 1.

16. S2 FIRST DAT =

19. S2 START MIN =

17. S2 LAST DAY =

20. S2 STOP HOUR =

18. S2 START HOUR =

21. S2 STOP MIN =

22. HOLIDAY MONTH #1—OFF: MicroTech has the ability to maintain up to 14 discrete holiday dates as OFF days. For any of the programmed holidays, the unit will remain off unless the OVERRIDE HOURS (#2 above) are used. The unit can have, for example, the following holidays and dates field set:

- | | |
|-------------------------|------------------------------|
| 1. New Year's Day 1/1 | 8. Columbus Day 10/12 |
| 2. M L King Jr Day 1/19 | 9. Veterans Day 11/11 |
| 3. President's Day 2/16 | 10. Thanksgiving 11/26 |
| 4. Easter 3/19 | 11. Day after T'Giving 11/27 |
| 5. Memorial Day 5/25 | 12. Christmas 12/25 |
| 6. July 4th 7/4 | 13. Special 0/0 |
| 7. Labor Day 9/7 | 14. Special 0/0 |

To disable any of the above 12 default holidays, change month and date to "0/0".

To display the first holiday month, press "CLOCK, SCHEDULE" twenty-two times and release. The following message will appear on the display:

22ND PRESS: #1 HOL MONTH = 1

To change the current "HOLIDAY MONTH" (with password entered), press the "+/YES" or "-/NO" keys until the new value is displayed and then press the "=/ENTER" key to enter change into memory.

23. HOLIDAY DATE #1—OFF: To display the first holiday date, press "CLOCK, SCHEDULE" twenty-three times and release. The following message will appear on the display:

23RD PRESS: #1 HOL DATE = 1

To change the current "#1 HOLIDAY DATE" (with password entered), press the "+/YES" or "-/NO" keys until the new value is displayed and then press the "=/ENTER" key to enter change into memory.

24. —49. HOLIDAY MONTH AND DATE #2 THROUGH 14: To view or change any of the other 13 OFF holidays, proceed in the same manner as 22 and 23 above.

SETPOINT KEY 5: "CANCEL, CLEAR DISPLAY"

This key is used to clear any value displayed on the 20 character display. Also used to stop the "DATA SCROLL" function, and to cancel any setpoint change before pressing the ENTER key.

If either password (OPERATOR or SERVICE) has been entered, pressing the "CANCEL, CLEAR DISPLAY" key will set the password timer to 1 minute and than disable password protection, preventing unauthorized personnel from tampering with setpoints.

SETPOINT KEY 6, 7, & 8: "+/YES", "-/NO" and "=/ENTER"

"+/YES": Used to increase (or answer questions) SETPOINT & SERVICE key values when proper password has been entered.

"+/NO": Used to decrease (or answer questions) SETPOINT & SERVICE key values when proper password has been entered.

"=/ENTER": Used to "ENTER"

C. Service Setpoints

The SERVICE keys can be divided into 3 groups: Fault History Display (fault history keys), System Setpoint (Set-up keys), and Service only (manual vane control and service setpoints keys).

The fault keys are not protected by any type of password protection, while the Set-up Options and Manual Vane Control are covered by the OPERATORS password for security purposes. The true service key, "SERVICE SET-POINTS," is protected by the SERVICE password.

SERVICE KEY 1: "MANUAL VANE CONTROL"

This key is used by service personnel for diagnostic purposes. It requires the OPERATORS password for access. With the proper password, the inlet guide vanes can be opened or closed (unit loaded or unloaded) for various machine evaluation and diagnostic purposes. During manual vane control, the display responds with a blinking display to inform the operator that the unit is no longer in automatic vane control. During the manual mode, other DISPLAY keys can be pressed after placing the unit in manual vane control while loading and unloading the machine. If, for example, the unit were in manual vane control and the MOTOR AMPS key were pressed, the display would read "MOTOR AMPS = XXX" with the "MOTOR AMPS" portion blinking to indicate the unit is in manual control. The unit will remain in manual vane control until the "CANCEL, CLEAR DISPLAY" key is pressed.

SERVICE KEY 2: "FAULT HISTORY"

This key is used to display the current and past eight safety shutdowns. To display the current safety shutdown fault, press the FAULT HISTORY service key once and release. The following message will appear on the 20 character display:

1ST PRESS: NOW = NO FAULT

This indicates that the machine is operating properly and is not OFF due to safety fault.

To display the "last" safety shutdown faults, press the FAULT HISTORY service key a second time and release. The following message will appear on the display:

2ND PRESS: LAST = NO EVAP FLOW

This would indicate that the unit was shut down on the last safety shutdown due to loss of evaporator flow. Pressing the "FAULT HISTORY" seven more times will display the last seven shutdowns. Each time a fault occurs, the other past faults are stepped further on the fault history list.

The following is a list of possible safety faults:

NO TRANSITION	HIGH MOTOR CUR
LOW SUMP TEMP	LVG EVP WTR SEN
HIGH FEED TEMP	ENT EVP WTR SEN
LOW EVAP PRESS	EVAPORATOR SEN
HIGH DIS PRESS	SUCTION SENSOR
HIGH DIS TEMP	LIQUID LINE SEN
SURGE	ENT CND WTR SEN
HI SUCTION TEMP	LVG CND WTR SEN
HIGH MOTOR TEMP	DISCHARGE SEN
STARTER FAULT	CONDENSER SEN
LOW CHARGE SW	OIL FEED SENSOR
NO EVAP FLOW	OIL SUMP SENSOR
NO COND FLOW	OIL PRESS SEN
LOW OIL PRESS	VANES OPEN

SERVICE KEY 3: "CLEAR FAULT"

This key is used to clear (reset) the current safety shutdown fault.

SERVICE KEY 4: "START UNIT"

This key is used to request startup of unit. The unit will start provided all "start" controls are in proper order (STOP/AUTO switch in AUTO, CLOCK SCHEDULE in RUN time period, today is not one of the programmed HOLIDAYS, remote START/STOP signal is in START position) and go through standard startup sequence. If the unit had shut down due to safety fault (and fault cleared) or stop/auto switch moved from STOP to AUTO, START UNIT key must be pressed.

SERVICE KEY 5: "SET-UP OPTIONS"

"SET-UP OPTIONS" key is used to set different unit configurations. Examples of different configuration would be whether the reset of leaving evaporator water temperature is by return water or from a remote EMS signal. "SET-UP OPTIONS" are protected by the OPERATORS or SERVICE password.

1. **RESET OPTIONS** — To display the current reset or demand limiting setting, press the "SET-UP OPTIONS" Service key once and release. The following message will appear on the 20 character display:

1ST PRESS: RESET OPTIONS = NONE

To change the type of reset/amp limiting, press the "+ /YES" or "- /NO" keys until a different value is displayed and then press the "= /ENTER" key to enter change into memory. The different types of reset/limiting are as follows:

- NONE: No chilled water reset methods or remote demand limiting functions are enabled.
- AMP: Remote input signal (4-20mA DC) is to demand limit the chiller. Reset shall be based on schedule in Section IV, Part B, Setpoint Key "MAX AMP LIMIT". This will change "REMOTE AMP LIM" to display "REMOTE AMP LIM = AMP".
- ChW: Remote input signal (4-20mA DC) is used to reset the leaving evaporator setpoint. Reset shall be based on schedule in Section IV, Part B, Setpoint Key "WATER TEMP'S". This will change "RESET LVG SPT" to display "RESET LVG SPT = ChW".
- ENT: Reset of chilled water (return water control) shall be enabled ("RESET LVG SPT = ENT"). See Section VI, Part E, "Entering Evaporator Setpoint," or Item 3 below.
- AMPENT: Remote input signal (4-20mA DC) is to demand limit the chiller and the reset from return water (return water control) will be enabled.
- AMPChW: Remote input signal (4-20mA DC) is to demand limit the chiller and reset leaving chilled water. Each shall be shown under their setpoint keys by "REMOTE AMP LIM = AMP" and "RESET LVG SPT = ChW".

2. **MAXIMUM CHILLED WATER RESET**: This is the amount (degrees) of reset that will be used when RESET OPTION = ChW. When reset of chilled water from a remote source is not being used, the MAX ChW RESET will be N/A. To display the current setting, press the "SET-UP OPTIONS" Service key twice and release. The following message will appear on the display:

2ND PRESS: MAX ChW RESET = N/A

To change the MAXIMUM amount of reset, press the "+ /YES" or "- /NO" keys until a different value is displayed and then press the "= /ENTER" key to enter change into memory. See Section See Section IV, Setpoint key "WATER TEMP'S" for reset schedule.

3. **ENTERING EVAPORATOR SETPOINT**: This is the setpoint for entering evaporator water control (when "RESET OPTION = ENT") is being used. When entering water control is not being used, the MAX ChW RESET will be N/A. To display the current setting, press the "SET-UP OPTIONS" Service key three times and release. The following message will appear on the display:

3RD PRESS: ENT EVAP SPT = N/A

To change the entering water setpoint, press the "+ /YES" or "- /NO" keys until a different value is displayed and then press the "= /ENTER" key to enter change into memory.

4. **ENTERING EVAPORATOR TIMER**: This is the amount of time between calculations when entering water control is being used ("RESET LVG SPT = ENT"). The microprocessor checks the actual entering evaporator water temp and compares it to the setpoint (see above #3) and will change the entering setpoint based on the amount of deviation. To display the current setting, press the "SET-UP OPTIONS" Service key four times and release. The following message will appear on the display:

4TH PRESS: ENT EVP TIMER = 5

This indicates that entering water control is being used and the control point is being recalculated every 5 minutes. To change the entering water timer, press the "+ /YES" or "- /NO" keys until a different value is displayed and then press the "= /ENTER" key to enter change into memory.

5. **START / STOP SIGNAL**

The chiller can be controlled to start or stop from a remote, contact closure (see field wiring diagrams in Section III). To display the current setting, press the "SET-UP OPTIONS" Service key five times and release. The following message will appear on the display:

5TH PRESS: START MODE = LOCAL

This indicates that remote start/stop is not being used. If remote control was enabled ("START MODE = REMOTE") on/off control is by way of remote contact closure. Change the status by pressing the "+/YES" or "-/NO" keys until the alternate value is displayed; then press the "=/ENTER" key to enter change into memory.

6. **STARTUP TEMPERATURE DIFFERENCE:** This is temperature difference above the current leaving evaporator setpoint that will start the unit after a standard "cooling load satisfied" shutdown. To display the current setting, press the "SET-UP OPTIONS" Service key six times and release. The following message will appear on the display:

6TH PRESS: STARTUP D-T = 3.0 F

This indicates that the unit will restart after the leaving evaporator water temperature reaches 3 degrees above the current leaving evaporator setpoint. The adjustable range is from 1 to 10 degrees. To change the value, press the "+/YES" or "-/NO" keys until a different value is displayed and then press the "=/ENTER" key to enter change into memory.

7. **SHUTDOWN TEMPERATURE DIFFERENCE:** This is temperature difference below the current leaving evaporator setpoint that will stop the unit after satisfying the cooling load. To display the current setting, press the "SET-UP OPTIONS" Service key seven times and release. The following message will appear on the display:

7TH PRESS: SHUTDOWN D-T= 3.0 F

This indicates that the unit will shutdown after the leaving evaporator water temperature reaches 3 degrees below the current leaving evaporator setpoint. The adjustable range is from 3 to 10 degrees. To change the value, press the "+/YES" or "-/NO" keys until a different value is displayed and then press the "=/ENTER" key to enter change into memory.

8. **START TO START TIMER:** The start-to-start timer is the required elapsed time the unit must run before the unit would be able to be restarted. To display the current setting, press the "SET-UP OPTIONS" Service key eight times and release. The following message will appear on the display:

8TH PRESS: START-START = 40 MIN

This indicates that the unit would need to run for 40 minutes before it could be started again. The adjustable range is from 20 to 60 minutes. To change the value, press the "+/YES" or "-/NO" keys until a different value is displayed and then press the "=/ENTER" key to enter change into memory.

9. **STOP TO START TIMER:** The Stop-to-start timer is the required time the unit must be OFF after a standard shutdown before the unit would be able to be restarted (Start-to-Start timer must also be satisfied). To display the current setting, press the "SET-UP OPTIONS" Service key nine times and release. The following message will appear on the display:

9TH PRESS: STOP TO START = 5 MIN

This indicates that the unit would need to be off for 5 minutes before it could be started again. The adjustable range is from 3 to 20 minutes. To change the value, press the "+/YES" or "-/NO" keys until a different value is displayed and then press the "=/ENTER" key to enter change into memory.

10. **EVAPORATOR LOAD DELAY:** This is the amount of time that will elapse before the leaving evaporator water temperature reading is taken after the evaporator pump has started. The timer is factory set for 15 seconds with a total range of 15 minimum and 240 seconds maximum. To display the current setting, press the "SET-UP OPTIONS" Service key ten times and release. The following message will appear on the display:

10TH PRESS: LOAD DELAY = 20 SEC

This indicates the evaporator pump will run for 20 seconds before the first reading of leaving

evaporator water temperature is taken. To change the entering water setpoint, press the "+/YES" or "-/NO" keys until the required value is displayed and then press the "=/ENTER" key to enter change into memory.

11. TOWER STAGE ONE ON: This is the head pressure differential (condensing pressure minus evaporator pressure) required to stage the first output contacts for tower fan control to ON. To display the current setting, press the "SET-UP OPTIONS" Service key eleven times and release. The following message will appear on the display:

11TH PRESS: TWR STG 1 ON = 50 PSID

This indicates the output contacts for tower stage one will be closed at head pressure differential (lift) of 50 PSID. The minimum differential is 45 PSID and the maximum is 55 PSID. To change the setpoint, press the "+/YES" or "-/NO" keys until the required value is displayed and then press the "=/ENTER" key to enter change into memory.

12. TOWER STAGE ONE OFF: This is the head pressure differential (condensing pressure minus evaporator pressure) required to shut OFF the first stage of cooling tower control. To display the current setting, press the "SET-UP OPTIONS" Service key twelve times and release. The following message will appear on the display:

12TH PRESS: TWR STG 1 OFF = 45 PSID

This indicates the output contacts for tower stage one will open when the head pressure differential (lift) drops below 45 PSID. The minimum differential is 35 PSID and the maximum is 45 PSID. To change the setpoint, press the "+/YES" or "-/NO" keys until the required value is displayed and then press the "=/ENTER" key to enter change into memory.

13. TOWER STAGE TWO ON: This is the head pressure differential required to stage the second output contacts for tower fan control to ON. To display the current setting, press the "SET-UP OPTIONS" Service key thirteen times and release. The following message will appear on the display:

13TH PRESS: TWR STG 2 ON = 55 PSID

The minimum differential is 50 PSID and the maximum is 60 PSID. To change the setpoint, press the "+/YES" or "-/NO" keys until the required value is displayed and then press the "=/ENTER" key to enter change into memory.

14. TOWER STAGE TWO OFF: This is the head pressure differential required to shut OFF the second stage of cooling tower control. To display the current setting, press the "SET-UP OPTIONS" Service key fourteen times and release. The following message will appear on the display:

14TH PRESS: TWR STG 2 OFF = 50 PSID

The minimum differential is 40 PSID and the maximum is 50 PSID. To change the setpoint, press the "+/YES" or "-/NO" keys until the required value is displayed and then press the "=/ENTER" key to enter change into memory.

15. START LAG UNIT SETPOINT: On multiple unit applications or dual compressor machines, this is the required % RLA on the operating unit before the second unit/compressor is brought on line. To display the current setting, press the "SET-UP OPTIONS" Service key fifteen times and release. The following message will appear on the display:

15TH PRESS: ENABLE LAG = 95%

The second unit/compressor will be started when the operating unit reaches 95% RLA for the "DELAY TIME" of 5 minutes (see below #17). The minimum enable value is 80% RLA and the maximum is 100% RLA. To change the setpoint, press the "+/YES" or "-/NO" keys until the required value is displayed and then press the "=/ENTER" key to enter change into memory.

16. DISABLE LAG UNIT SETPOINT: On multiple unit applications or dual compressor machines, this is the required % RLA on the operating units/compressors before lag unit is shut down. To display the current

setting, press the "SET-UP OPTIONS" Service key sixteen times and release. The following message will appear on the display:

16TH PRESS: DISABLE LAG = 40%

The lag unit/compressor will be shutdown when the operating units reached 40% RLA for the "DELAY TIME" of 5 minutes (see below #17). The minimum disable value is 35% RLA and the maximum is 60% RLA. To change the setpoint, press the "+/YES" or "-/NO" keys until the required value is displayed and then press the "=/ENTER" key to enter change into memory.

17. ENABLE / DISABLE DELAY TIMER: On multiple unit applications or dual compressor machines, this is the required time needed at either Enable RLA setpoint or Disable RLA setpoint before units are started or stopped. To display the current setting, press the "SET-UP OPTIONS" Service key seventeen times and release. The following message will appear on the display:

17TH PRESS: DELAY TIMER = 5 MIN

For enabling a unit, the lead unit must be at or above 95 % RLA for 5 minutes before the second unit will be started. The minimum delay time is 1 minute and the maximum is 10 minutes. To change the value, press the "+/YES" or "-/NO" keys until the required value is displayed and then press the "=/ENTER" key to enter change into memory.

SERVICE KEY 6: "SERVICE SETPOINTS"

This key is used by service personnel to access the safety faults for the unit. This key requires the SERVICE password for access.

The following is a brief description of each of the safeties and their associated setpoints and ranges.

1. LAST START: Last start is the time (in minutes) that have elapsed since the unit's last start. This includes the time that the unit may have spent while OFF due to a standard shutdown. To view the current time elapsed since LAST START, press the "SERVICE SETPOINTS" Service key once and release. The following message will appear on the 20 character display:

1ST PRESS: LAST START=255MIN

The maximum time able to be displayed on the "LAST START" timer is 255 minutes (4.3 hours).

2. 100 % RATED LOAD AMPS (RLA): The 100 percent rated load amps is a factory set value used by the microprocessor to display the operating amps. To see the 100 % RLA value, press the "SERVICE SETPOINTS" Service key twice and release. The following message will appear on the 20 character display:

2ND PRESS: 100 % RLA = 50 A

3. LOW MOTOR CURRENT CUTOOUT. This is a protective safety used to stop/disable the unit from the starter whenever the % RLA measurement by MicroTech is below 10 % RLA.
4. HOT GAS BYPASS SETPOINT: This is the % RLA that hot gas bypass will come on when the unit is equipped with hot gas. To display the HOT GAS SPT, press the "SERVICE SETPOINTS" Service key four times and release. The following message will appear on the 20 character display:

4TH PRESS: HOT GAS SPT =40 %

5. LOW OIL SUMP TEMPERATURE DIFFERENTIAL: This safety control is used to prevent unit operation when temperature differential between the oil sump and evaporator is to low. To display the LOW OIL DELTA, press the "SERVICE SETPOINTS" Service key five times and release. The following message will appear on the 20 character display:

5TH PRESS: LOW OIL DELTA=50 F

The minimum setpoint is 40 degrees F and the maximum is 60 F.

6. **CALCULATED OIL TEMPERATURE SETPOINT:** This safety control is used to prevent unit operation when calculated oil temperature setpoint reaches unsafe conditions. To display the CALC OIL SPT, press the "SERVICE SETPOINTS" Service key six times and release. The following message will appear on the 20 character display:

6TH PRESS: CALC OIL SPT =101 F

7. **HIGH OIL FEED TEMPERATURE SETPOINT:** This safety control is used to prevent unit operation when oil feed temperature to the compressor goes above setpoint. To display the HIGH OIL FEED, press the "SERVICE SETPOINTS" Service key seven times and release. The following message will appear on the 20 character display:

7TH PRESS: HIGH OIL FEED=140 F

The minimum setpoint is 130 degrees F and the maximum is 140 F.

8. **LOW EVAPORATOR PRESSURE SETPOINT:** This safety control is used to stop the compressor whenever the pressure reaches setpoint or below. To display the LOW EVAP PRES, press the "SERVICE SETPOINTS" Service key eight times and release. The following message will appear on the display:

8TH PRESS: LOW EVAP PRES=31PSI

The minimum setpoint is 10 PSI and the maximum is 50 PSI.

9. **LOW EVAPORATOR PRESSURE OVERRIDE:** This safety control is used to unload the compressor whenever the pressure reaches its setpoint pressure above the low pressure cutout (#8 above). To display the LP OVERRIDE, press the "SERVICE SETPOINTS" Service key nine times and release. The following message will appear on the display:

9TH PRESS: LP OVERRIDE = 3PSID

The minimum setpoint is 1 PSID and the maximum is 6 PSID.

10. **HIGH DISCHARGE TEMPERATURE:** This safety control is used to stop the compressor should the discharge temperature reach unsafe conditions. To display the HI DISCHARGE, press the "SERVICE SETPOINTS" Service key ten times and release. The following message will appear on the display:

10TH PRESS: HI DISCHARGE =190 F

The minimum setpoint is 100 degrees F and the maximum is 235 F.

11. **HIGH SUCTION TEMPERATURE DURING UNIT OPERATION:** This safety control is used to stop the compressor should the suction temperature during unit operation reach unsafe conditions. To display the HI SUCT RUN, press the "SERVICE SETPOINTS" Service key eleven times and release. The following message will appear on the display:

11TH PRESS: HIGH SUCT RUN= 95 F

The minimum setpoint is 30 degrees F and the maximum is 50 F.

12. **HIGH SUCTION TEMPERATURE BEFORE UNIT STARTUP:** This safety control will not allow the unit to start should the suction temperature be above setpoint. To display the HI SUCT OFF, press the "SERVICE SETPOINTS" Service key twelve times and release. The following message will appear on the display:

12TH PRESS: HIGH SUCT OFF= 125 F

The minimum setpoint is 100 degrees F and the maximum is 200 F.

13. **HIGH CONDENSER PRESSURE CUTOUT:** This safety control will stop the compressor should the condenser pressure reach unsafe conditions. To display the HI COND PRES, press the "SERVICE SET-

POINTS" Service key thirteen times and release. The following message will appear on the display:

13TH PRESS: HI COND PRES =140 PSI

The minimum setpoint is 100 PSI and the maximum is 225 PSI.

SERVICE KEY 7: "CHANGE PASSWORD"

Pressing "change password" key will display the regional McQuay service phone number to contact for password alteration.

SERVICE KEY 8: "? HELP"

Pressing the "? HELP" key will display the regional McQuay service phone number to contact for additional help.

V. Startup, Operation, and Shutdown Sequence

The MicroTech equipped chiller will be in one of three modes at any one time: OFF (load satisfied, fault shutdown, manual switch in "OFF" position, etc.), STARTUP/SHUTDOWN (call for cooling, cooling load satisfied, safety shutdown, etc.), or RUNNING OK.

A. Unit OFF

Current chiller status can be accessed at any time through the MicroTech control panel. The status during an off mode can be tested by pressing the "UNIT STATUS" key under the DISPLAY section of the control panel front. Depending on the machine's condition, it will respond with a message explaining its status. (If there wasn't a response, check that there is power to the unit starter and control system). The possible display outputs are:

1. "OFF: MANUAL SWITCH". This response indicates that the STOP/AUTO rocker switch is in the STOP position. The machine will never operate while this switch is in the STOP position. If start-up is required, flip rocker switch to the "AUTO" position and press the "START UNIT" key under the service section.
2. "OFF: READY TO START". Displayed when the unit is in proper operating condition (not OFF due to chiller or external system fault). Pressing the "START UNIT" key will determine reason for not starting or proceed to start unit (see section B. Starting Unit).
 - a. "OFF: WAITING FOR LOAD". The chiller is ready to start (automatic operation and "START UNIT" key does not have to be pressed for unit to start) and has determined that the current leaving chilled water temperature is not greater than or equal to the chilled water setpoint plus start-up delta-temp. Once the chilled water system temperature rises above the start-up temperature, the unit will automatically start without an operator request for startup.
 - b. "OFF: REMOTE SIGNAL". This message indicates the unit has been programmed to START and STOP based on a remote contract closure. See "START MODE" under "SET-UP OPTIONS" key for more information. The unit, when programmed for remote START/STOP, will initiate start-up when START contact is closed.
 - c. "OFF: SYSTEM CONTROL". Another higher ranking controller (LLLB or CPC panel) is preventing unit operation via direct twisted pair communication link due to inadequate load for multiple chillers or expanded time clock scheduling by these panels.
3. "OFF: DUE TO FAULT". The chiller has experienced a safety shutdown (fault). Until the fault has been corrected and cleared, the unit will remain OFF. By pressing the "FAULT HISTORY" key under SERVICE section of keypad, the operator will see the current fault that has stopped machine operation. Additional key presses will display the last eight safety shutdowns giving the operator a trend to machine's operating history. The operator is required to clear the fault by pressing "CLEAR FAULT" in order to reset the MicroTech control system before pressing "START UNIT" and allowing machine to operate. When a fault is cleared, the "current" fault becomes the last fault, the "last" fault becomes 2nd fault ago, etc., incrementing each fault one back in the fault history list. The possible fault shutdowns are:

1. NO FAULT	10. HIGH MOTOR TEMP
2. NO TRANSITION	11. STARTER FAULT
3. LOW SUMP TEMP	12. LOW CHARGE SW
4. HIGH FEED TEMP	13. NO EVAP FLOW
5. LOW EVAP PRESS	14. NO COND FLOW
6. HIGH DIS PRESS	15. LOW OIL PRESS
7. HIGH DIS TEMP	16. LOW MOTOR CURR
8. SURGE	17. VANES OPEN
9. HI SUCTION TEMP	18-31. SENSOR FAILURES (14)
4. "WILL START IN XX MIN". The chiller will remain OFF for XX minutes at which time it will evaluate if the system water temperatures and shall proceed to start-up or wait for load. The most common occurrence of this display is when the protective cycle timers (Start-to-Start and Stop-to-Start timers) have not elapsed, preventing the machine/compressor/motor from exceeding 3 starts per hour. This will also automatically appear during a normal load recycle so as to indicate the soonest time the chiller may operate.

5. "WAITING LOW SUMP T". The temperature of the oil has not reached an adequate level in order to remove entrained refrigerant for the oil. The oil temp must be maintained at least 50 degrees (adjustable) above the evaporator refrigerant temperature for this to occur.
6. "LOAD RECYCLE". The system cooling load has been satisfied and machine operation is not required. When the leaving evaporator water temperature does reach the start-up point, the control system will automatically proceed to start-up.
7. "TIME SCHEDULE". Programmed schedule S1 or S2 under CLOCK, SCHEDULE are preventing unit operation do to OFF request of either schedule. Should machine operation be required during the OFF time of either S1 or S2, OVERRIDE HOURS can input to bypass or override the time schedule (See Programming section on OVERRIDE for more details of bypassing S1/S2 schedules).

B. Starting Unit

The normal start-up sequence occurs provided that all time delays are satisfied, remote and local on/off switches are in proper position, timeclock is in an "ON" time period, and the unit is not off due to fault. By placing the "STOP/AUTO" switch in the "AUTO" position and pressing "START UNIT" key in SERVICE section of keypad, the unit will evaluate the leaving evaporator water temperature for possible unit operation. (Note: If Remote Start/Stop is being used by having the Start Mode programmed to "REMOTE", pressing the "START UNIT" key is not required). The control panel display will display "EVAP PUMP ON XX" to indicate that the evaporator pump has been started and will operate for XX seconds (15 seconds default, adjustable from 15 seconds minimum to 240 seconds maximum) before evaluating the leaving evaporator water temperature. This delay in temperature sensing allows for a true system water temperature to be taken and not a false reading of the standing water in the unit prior to starting.

The start-up procedure will continue provided the leaving water temperature is above the CHILLED WATER SETPOINT plus STARTUP DELTA-T (see Set-up Options key in Service section of prior chapter for definition). A typical situation would be a chilled water temperature of 48.3°, CHILLED WATER SETPOINT of 44.0°F and START-UP DELTA-T of 3.0°F (3.0°F min.—20°F max). In this case the difference between the actual leaving water temperature and setpoint is larger than the START-UP DELTA-T (48.3 minus 44 is greater than 3.0); therefore, cooling is required and the unit will proceed to the next step in the start-up sequence. If the actual leaving chilled water temperature (45.6 for example) minus the SETPOINT temperature had been less than the START-UP DELTA-T of 3.0 (45.6 minus 44 is less than 3.0), the MicroTech display will read "WAITING FOR LOAD", indicating the leaving chilled water temperature is not high enough for the chiller to continue start-up sequence.

During the "WAITING FOR LOAD" condition, the evaporator pump will continue to operate (if the pump is being controlled by the MicroTech unit controller), until the MicroTech Chiller System is shut down (Time Schedule to OFF mode, STOP/AUTO switch to OFF position, Remote Start/Stop to Stop, etc.). Evaporator pump operation allows the air side of the system (fan-coils, air handling units, etc.) to provide cooling until the Time Schedule, STOP/AUTO switch, or Remote Start/Stop stops the pump or the chilled water temperature rises above the START temperature requirement of the chiller.

When cooling is required, the control system will first check for proper oil sump temperature, making sure it is above the temperature required to maintain refrigerant-free oil during off periods. (Oil sump temperature = EVAP TEMP plus LOW OIL DELTA). If the oil sump temperature is OK, the control panel will energize the Oil Pump Contactor, (OP) starting the oil pump motor for pre-start lubrication (energizing OP relay causes main oil heaters to be de-energized). The oil pump will operate for a non-adjustable total elapsed time of 30 seconds prior to actual compressor start (energizing MCR's), during which time the oil pressure must be a minimum of 60 psig above the evaporator pressure in order to supply adequate lubrication.

During the 30 second pre-lubrication, the UNLOAD light on the panel front will be ON. This indicates that the inlet guide vanes are being driven closed to prevent starting the machine in a loaded condition. Simultaneously, the condenser water pump relay (CWR) will be energized by the control system. This allows condenser pump operation prior to compressor start to insure proper flow switch closure and communication of pump operation (Aux cond pump interlock) to MicroTech. The condenser water pump start time (seconds before energizing compressor) can be adjusted from 5 seconds minimum to 240 seconds maximum with a default value of 5 seconds.

After completion of the above steps, the Mother Board will energize the Motor Control Relays (MCR1 & MCR2) through the Output Board, beginning the starter sequence [MCR energized first through latching

relay output #3 (timed open)] on Output Board and then connected by main output relay #14 on Output Board). Critical inputs to the MicroTech system from the starter include the confirmation of MCR1 and MCR2 action by way of auxiliary contacts, starter fault indication from the starter (not available with McQuay self-manufactured starters), and proper starter transition (not applicable on across-the-line starters).

Display	LED Status Of Daughter Board	LED Status Of Output Board
OFF: READY TO START	ON: 1-2, 4-7, 11 OFF: 3, 8-10, 12	5, 7 0-4, 6, 8-15
WILL START IN 02 MIN	ON: 1-2, 4-7, 11 OFF: 3, 8-10, 12	5, 7 0-4, 6, 8-15
EVAP PUMP IS ON 15	ON: 1-2, 4-7, 9, 11 OFF: 3, 8, 10, 12	5, 7, 11 0-4, 6, 8-10, 12-15
OIL PUMP IS ON 30	ON: 1-7, 9, 11-12 OFF: 8, 10	0, 7, 11, 13 1-6, 8-10, 12-15
COND PUMP IS ON 10	ON: 1-9, 11-12 OFF: 10	0, 7, 11-13 1-6, 8-10, 14-15
MCR IS ON 30	ON: 1-12 OFF:	0, 3*, 7-9, 11-14 1, 2, 4-6, 10, 15
UNIT IS RUNNING OK	ON: 1-12 OFF:	0/1**, 7-9, 11-14 0/1**, 2-6, 10, 15

- * — Output Board Relay 3 is energized and timed open.
- ** — Output Board Relay 0 energized to unload compressor.
Output Board Relay 1 energized to load compressor.
During compressor hold condition 0 & 1 are OFF.

LED Description	Daughter Board	Output Board
0		UNLOAD SOLENOID
1	SURGE GUARD ①	LOAD SOLENOID
2	MOTOR TEMP	HOT GAS SOLENOID ③
3	OIL DIFF PRES	MCR LATCH RELAY
4	HIGH DISCHARGE PRES	NOT USED
5	EVAP LOW PRES	OIL SUMP HEATER
6	PANEL STOP/AUTO SW	LIQ INJECTION ③
7	STARTER FAULT ②	ALARM RELAY
8	COND FLOW SW & PUMP	COOLING TWR STG 1
9	EVAP FLOW SW & PUMP	COOLING TWR STG 2
10	STARTER TRANSITION	NOT USED
11	REMOTE START/STOP	EVAP WATER PUMP
12	VANE CLOSE SWITCH	COND WATER PUMP
13		OIL PUMP CONTACTOR
14		MCR
15		NOT USED

- NOTES: ① Not used on 048/050 compressors.
② Not used on McQuay self-manufactured starter.
③ Used when unit is so equipped.

C. Unit Operating

The chiller's status during operation can be accessed by pressing the "UNIT STATUS" key under the DISPLAY SECTION. The output will indicate that the "UNIT IS RUNNING OK". Additional key presses of the "UNIT STATUS" key will show the MicroTech's "status" of different control features as shown below in 1—7.

The status of any control feature such as demand limiting—local or remote, chilled water reset functions, soft load off/active, etc., can be obtained by pressing the "UNIT STATUS" key. When a "status" is OFF, the

control is not ON or taking place. For example, when Remote Reset = OFF, the MicroTech panel is not resetting the leaving chilled water from a remote BAS 4-20 mA dc signal. On the other hand, if the "status" was "ACTIVE", the panel is resetting its chilled water setpoint based on an input from a BAS system. The following seven "status" indications are the key presses from the "UNIT STATUS" key.

1. **ENTERING WATER RESET.** When the panel is programmed to reset the leaving chilled water based on return water (return water control) the status will be ACTIVE. This programming is accomplished by setting the "RESET OPTIONS" under the Service SET-UP OPTIONS to ENT. When reset based on entering water is inoperative, the status will be OFF. See "Keypad Section—Service Keys" under Section II for a description of reset and demand limiting arrangements available and Section VI for programming of Return Water Reset.
2. **REMOTE RESET.** This will be ACTIVE when the RESET OPTION is programmed to ChW (reset leaving chilled water temperature based on an 4-20 mA dc input signal from a Building Automation System (BAS). See part Section II or VI for more information.
3. **SOFT (RAMP) LOADING.** Ramp loading will be ACTIVE whenever the unit is in a start-up mode and is being limited to the maximum operation amps when SOFT LOAD feature is used on initial unit start-up. The status will go to an OFF status after the "RAMP UP TIME" has expired or when the soft load is not being used. See part Section II or VI for more information.
4. **LOW PRESSURE UNLOADING.** As a safety precaution, the MicroTech control system automatically unloads the compressor if an unsafe evaporator temperature occurs. The low pressure unloading will be ACTIVE whenever the compressor is unloading/closing the inlet guide vanes. The point at which the Low Pressure Unloading (low pressure override) takes place is the evaporator temperature/pressure at which freezing may occur. The unload temperature is safety cutout temperature (33°F for water) plus the unload differential above this point. It is the control system's intent to first unload the compressor, thereby raising the evaporator temperature to a safe condition and, as a protective measure, stop unit operation if the temperature reaches the solution's freezing point. The compressor cutout point is based on the evaporator pressure and is a Service Setpoint called LOW EVAP PRES with a default value of 31 PSIG for R-12 (equivalent refrigerant temperature of 33.1°F) with plain water. The unload point is based on a Service Setpoint differential called LP OVERRIDE (low pressure override) with a default of 3 PSID (31 PSI + 3 PSI = 34 PSIG with an equivalent temperature of 36.6°F). LOW EVAP PRES and LP OVERRIDE require the Service password for changes. Note: As an added safety precaution, the MicroTech system is the only chiller control system to have a mechanical safety backup for low pressure cutout (MLP—Mechanical Low Pressure cutout). This safety backup stops the compressor if the unload feature and low evaporator cutout (software programmed) failed to occur.
5. **MAX AMP LIMIT.** The Maximum Amp Limit will be ACTIVE when the compressor reaches 100 percent of the unit's Rated Load Amps or higher. During the ACTIVE mode the control system will unload the unit by closing the inlet guide vanes in order to reduce the RLA to 100 percent or less.
6. **REMOTE AMP LIMIT.** When the MicroTech panel is receiving a BAS signal for demand limiting (preventing percent RLA from exceeding a specified amount) by having the Reset Options under Service Set-up Options (see part Section II or VI for more information) programmed to AMP, the status will be ACTIVE whenever the limiting of RLA occurs. If the input BAS signal is limiting the amp draw at a point above the present operating amps, the function will be OFF.
7. **MANUAL AMP LIMIT.** In order to prevent a unit from operating above a specified percent RLA, the Demand Limiting feature may be set at the control panel front. The operator may do so by entering the proper OPERATORS PASSWORD and setting the MAX AMP LIMIT (first key press of Setpoint key "MAX. AMP LIMIT") to the desired percent of RLA. Whenever the unit's RLA reaches this setpoint, the status of "MANUAL AMP LIMIT" will be active and the unit will be prevented from exceeding that amp limit.

VI. Programming MicroTech

The programming of any MicroTech setpoint or control feature requires the input of the proper password. The first level password is called the OPERATOR password and is a combination of four key presses on the keypad front. Access to any of the setpoints (leaving chilled water temperature), control functions (maximum amp limit, ramp loading, etc.) or set-up options (interface between the chiller and outside devices such as cooling tower stage control or Building Automation system) require the OPERATOR password to change values. No password is required to DISPLAY any setpoint value, control point, feature or service setpoint. It is the intention of the password protection scheme to prevent changes by unauthorized personnel, allowing only the OPERATOR to make changes to the chiller control system.

The OPERATOR password is entered as follows:

1. Press any of the SETPOINT keys to be changed (i.e., "WATER TEMP'S", "MAX. AMP LIMIT", "SOFT LOAD", or "CLOCK, SCHEDULE") until requested setpoint is displayed.
2. Press the "+/YES" or "-/NO" key.
3. The following message will be displayed: "ENTER PASSWORD:".
4. Enter the OPERATOR password (four key presses). After each key press a square block will be illuminated on the display after "ENTER PASSWORD:" one for each password key entered.
5. After the fourth key press the following message will be displayed "OPERATOR PASSWORD OK" if the password is correct.
6. Press the appropriate key until the setpoint or option to be changed is displayed.
7. Use the "+/YES" or "-/NO" keys to modify parameter. The original setpoint will change to a different value that will be displayed in a blinking manner. Step 8 must be completed in order for value to be entered into the program memory. If the new value is incorrect or not wanted, press "CANCEL, CLEAR DISPLAY" to erase and repeat Step 6.
8. Use "=/ENTER" key write the change to the MicroTech memory. The value will not be placed into memory until the "=/ENTER" key is pressed.

NOTE: Once a password is entered, the controller starts a ten minute countdown. During the next ten minutes, the operator is authorized to make other parameter changes without re-entering the password. Each time a parameter is changed, the password timer is reset to 10 minutes.

By pressing the "CANCEL, CLEAR DISPLAY" the password timer is set to 1 minute and password authorization will expire in one minute. This procedure is recommended when leaving the area in order to eliminate the possibility of access by unauthorized personnel.

A. Water Temperature

1. CHILLED WATER SETPOINT. To change the leaving evaporator setpoint to a new value, press the "WATER TEMP'S" key once. The information displayed will be: "LVG EVAP SPT = 44.0" where the setpoint NOW is 44.0. To change this value to 45.0 F for example, press the "+/YES" key once (at this point the panel will ask for the proper password if not already entered (see above steps 1-8 for procedure to enter password). The display will now indicate "LVG EVAP SPT = 44.2" with the 44.2 blinking ON and OFF. The blinking of the displayed temperature indicates that the value has been changed but has not yet been entered into the memory. Pressing the "+/YES" key four additional times will display the new value of 45.0 and by pressing the "=/ENTER" key will write the value to the controller memory and be the new Leaving Evap Setpoint. If a parameter is changed to an incorrect value, pressing the "CANCEL, CLEAR DISPLAY" while the display is blinking will erase that value before it is written to the memory.
2. RESET LEAVING SETPOINT. The RESET LEAVING SETPOINT is a calculated setpoint used to indicate what temperature the MicroTech is trying to maintain IF reset from return water or reset from remote source is being used. These reset schedules are turned ON or OFF by the "Reset Options" under "Set-up Options" key. Program to ENT for reset from return water or ChW for reset from remote source (BAS system). If the Reset Option = NONE, the "RESET LVG SPT" will display "N/A", indicating that reset not being used.

When "Reset Options" is programmed to ENT (entering evaporator water control), the Reset Leaving Setpoint shown will be the leaving water temperature "setpoint" required in order to maintain a constant entering evaporator water temperature. The entering evaporator setpoint is "ENT EVAP SPT" found under the "Setup Options" key and is typically the full load design entering evaporator water

temperature. Also used in the calculation of the Reset Leaving Setpoint is how often the reset setpoint is calculated, called "ENT EVP TIMER" and is found under the "Set-up Options" key. The default value is 5 minutes, with minimum time of 2 minutes and maximum time of 60 minutes. This timer controls how often the Reset Leaving Setpoint is changed and how close or accurate the controller maintains the entering setpoint. The "RESET LVG SPT" will decrease when the chiller is loading, and increase when the chiller unloads.

When "Reset Options" is programmed to CHW, the leaving water setpoint is being raised based on a Building Automation Signal (BAS) input of 4-20 mA. The amount of reset per mA is based on the "Set-up Option" called "MAX CHW RESET". The value is between 0 and 15.0 in 0.2 degree F increments with a typical value of 10.0°F. For example, if the "MAX CHW RESET = 10.0", the chilled water setpoint is 44.0 and a reset signal input of 10.0 mA, the "RESET LVG SPT" would be 47.8 [with 10 degrees of reset per 16 mA (20-4), degrees reset per mA is 10/16 or .625, mA for reset is 10 mA less 4 mA or 6, and therefore reset setpoint is $44 + (6 * .625) = 47.8$. See Section II, Part D. "Setpoint," for a graphic representation of remote reset setpoint].

3. REMOTE RESET SIGNAL. Also displayed under the Setpoint "WATER TEMP" key is the value "RMT RESET SIG", which is the remote reset signal currently being input to the control panel.

B. Maximum Amp Limit

1. The Maximum Amp Limit displayed by the first key press of the Setpoint key "MAX. AMP LIMIT" is the LOCAL demand limit setpoint. Demand limiting prevents drawing more current than the displayed value and will unload the chiller if it is above the programmed setpoint. To change the "MAX AMP LIMIT", press the "MAX. AMP LIMIT" key once to display "MAX AMP LIMIT = 90" (demand limit now set at 90 percent) and use the "-/NO" or "+/YES" key to change the value and the "=/ENTER" to enter the value into memory.
2. REMOTE AMP LIMIT. When "Reset Options" is programmed to AMP, the demand limit setpoint is based on a remote 4-20 mA BAS input signal. The demand limit setpoint is a straight line function where a 4 mA input signal is 100 percent demand limit (no limiting) and 20 mA is limiting the maximum percent RLA of 40.
3. REMOTE AMP SIGNAL. The remote amp limit setpoint can be displayed by pressing the "MAX AMP LIMIT" key twice to display "REMOT AMP LIM = 78%" and the BAS input signal can be viewed by pressing the key a third time to display "REMOT AMP SIG = 10.0 ma" (see Section II, Part A — "Setpoint" for a graphic representation of remote demand limiting setpoint).

C. Soft (Ramp) Loading

On the initial startup of a chiller, it is desirable to limit the amount of power (percent RLA) drawn by the chiller. The reason for this is to avoid possible power demand charges and prevent overloading the chiller during morning startup. The actual system load may be very low, but the load seen by unit is high because of the high loop water temperature. Ramp-up or soft loading will gradually pull down the loop temperature by allowing a smooth and steady increase in the unit amp draw. The soft load feature is controlled by two setpoints: Initial % RLA and a Ramp Time. The Initial RLA point is the chiller's initial start point, programmable from 30 to 100 % and the Ramp Up or Load Time will be the length of time spent ramping to full unit capacity, 0 to 120 minutes.

1. SOFT LOAD LIMIT. Soft Load Limit is the value to which the chiller amp draw will be limited when the Soft Load feature is used. To find out if a chiller's ramp function is "ON" or "OFF" press the "SOFT LOAD" key to display "SOFT LOAD LIM = N/A (Soft Load not in use at startup) or "SOFT LOAD LIM = 78%", showing that the unit is being "demand limited" to 78 % RLA because of a ramp-up start.
2. BEGINNING AMP LIMIT. To set the initial % RLA for the ramp-up function, press the "SOFT LOAD" key twice and use the "-/NO" or "+/YES" key to change the value and the "=/ENTER" to enter the value into memory. Minimum value 30%, maximum 100%.
3. RAMP UP TIME. To change the ramp-up time, press the "SOFT LOAD" key a third time to display "BEG AMP LIMIT = 30%" and use the "-/NO" or "+/YES" key to change the value and the "=/ENTER" to enter the value into memory. Minimum value is 0 (Soft Load OFF) and maximum value is 120 minutes.

D. Timeclock, Time Schedule and Holiday Schedule

1. **TIMECLOCK.** To keep track of the operating schedule for chiller ON/OFF control, the MicroTech controller must know the correct time, day, month, date, and year. This information is maintained and kept track of in the timeclock in the Display Processor (lithium battery backed timeclock). To display the current time, press the "CLOCK, SCHEDULE" key once. The output display will show "CURRENT TIME = 17:30" (military time; i.e., 5:30 pm).

To set the timeclock, press the "CLOCK, SCHEDULE" key three times to display "HOUR NOW, 0-23=17" and use the "-/NO" or "+/YES" key to change the value and the "=/ENTER" to enter the value into memory. Additional presses of the "CLOCK, SCHEDULE" key will step through the MINUTES (0-59), SECONDS (0-59), DAY OF THE WEEK (SUN = DAY1 to SAT = DAY7), MONTH (1-12), DATE (1-31), and YEAR (0-99) all of which can be changed by using the "-/NO" or "+/YES" key and the "=/ENTER" key.

The operator is required to change the current time for Daylight Saving Time.

2. **CLOCK SCHEDULE.** The MicroTech control system includes two 7-day repeatable time schedules for chiller ON/OFF control. The two schedules, S1 and S2, allow the chiller control system to operate the evaporator water pump on a programmable time schedule to allow chiller operation when cooling is required. Schedule 1 (S1) could be set to start the chiller on Monday through Friday at 7:15 am and stop the unit at 5:30 pm (17:30 military time) and Schedule 2 (S2) could be used to complement S1 by starting the chiller on Saturday at 7:30 and stopping it at 12:30 pm. The schedules in effect allow for the MicroTech to operate the evaporator pump during the ON periods and start and stop the compressor/unit based on the chilled water temperature and load.

To program the time schedules (assuming proper password authorization already entered) press the "CLOCK, SCHEDULE" key ten (10) times to the start day of Schedule 1 or until the display reads: "S1 FIRST DAY = OFF". The available start day combinations are Sunday through Saturday and "OFF". When S1 (START DAY and/or STOP DAY) is programmed to "OFF" the timeclock schedules, S1 and S2, are disabled and the unit will operate based on the STOP/AUTO switch on the panel front or a remote START/STOP signal input. To change the S1 schedule to the operative mode from "OFF", press the "+/YES" key when "S1 FIRST DAY = OFF" is displayed until the correct day is displayed. If the schedule described in the above paragraph were being programmed, pressing the "+/YES" key once will change the display "S1 FIRST DAY = OFF" to "S1 FIRST DAY = Sun" with "Sun" blinking ON and OFF to indicate a change has been made to the original displayed condition. Another press of the "+/YES" key will step the display to "S1 FIRST DAY = Mon" and pressing the "=/ENTER" key will enter Monday as the START DAY for Schedule S1.

Pressing the "CLOCK, SCHEDULE" key again will display "S1 LAST DAY = OFF". By pressing the "+/YES" key until "S1 LAST DAY = Fri" and entering the value by pressing "=/ENTER" key the S1 schedule has been programmed to allow operation Monday through Friday. To program the start times for S1, press the "CLOCK, SCHEDULE" key to display "S1 START HOUR = 0" and use the "+/YES" or "-/NO" key to alter the S1 start hour to 7 in our example above and pressing the "=/ENTER" to record value. Pressing the "CLOCK, SCHEDULE" key again will display "S1 START MIN = 0" indicating the start minute is 0 minutes after the hour. Press the "+/YES" or "-/NO" key to alter the S1 start minute to 15 and enter value. Pressing "CLOCK, SCHEDULE" again will display the "S1 STOP HOUR = 0" and can be changed to 17 (military time) with "+/YES" and "=/ENTER" key. Pressing "CLOCK, SCHEDULE" again will display the "S1 STOP MIN = 0" which can be changed to 30 minutes after the hour for the above example.

The alteration of Schedule 2 (S2) is handled in similar manner to S1 by pressing the "CLOCK, SCHEDULE" following S1 schedule for S2 START DAY, STOP DAY, START HOUR and MINUTE, STOP HOUR and MINUTE. Schedule S2 can be disabled and not used by setting the START and/or STOP DAY to "OFF". Note: If only 1 schedule is used for chiller operation, it must be S1 with S2 set to "OFF".

Continuous 24 hour daily operation can be set by programming the schedule to operate for START HOUR = 0 and START MINUTE = 0 until to the STOP HOUR = 23 and STOP MINUTE = 59 for specific days during the week. If Schedule S1 were set for Monday through Friday operation and setup for continuous "ON" as shown here, the chiller will allow operation after 12 Midnight Sunday (Hour:Minute:Second of 00:00:00 Monday) until 12 Midnight Friday (23:59:59 Friday). A more sophisticated combination using S1 and S2 could be designed to allow continuous operation of the chiller from Monday AM to Friday PM as shown here:

	SUN	MON	TUE	WED	THU	FRI	SAT
S1 ON		8:00	8:00	8:00	8:00		
S1 OFF		23:59	23:59	23:59	23:59		
S2 ON			0:00	0:00	0:00	0:00	
S2 OFF			17:00	17:00	17:00	17:00	

The schedules will continue on a weekly basis (repeats the same Sunday through Saturday schedule) until changed by the operator.

3. **OVERRIDE HOURS DURING OFF MODES.** When using S1 and S2 schedules, the unit will display "OFF: READY TO START". When a "START UNIT" is requested, the display will indicate "OFF: "OFF: TIME SCHEDULE". If chiller operation were required during the OFF periods of S1 or S2, the operator could program the chiller to override the time schedules and operate for an adjustable time. To set the Override time during a normally "OFF" time period (password required), press the "CLOCK, SCHEDULE" key twice to display "OVERRIDE(HRS) = 0.0" and use the "+/YES" or "-/NO" keys to change the run time and the "=/ENTER" to enter the value into memory.

After the Override hours are entered, the operator must press the "START UNIT" key. During override operation, the evaporator pump will be energized by MicroTech (if used) and cycle the chiller based on system load. Unit operation will continue until the override hours have expired and the machine returns to OFF Time Schedule.

4. **HOLIDAY SCHEDULE.** The MicroTech control system includes a Holiday schedule that allows the operator to program up to a year in advance 14 separate "OFF" days or holidays in the memory. The chiller will not operate for the entire 24 hour period of a programmed holiday even if the S1 or S2 schedules indicate chiller operation.

The holidays are set after the time schedules S1 and S2 under the "CLOCK, SCHEDULE" key. By pressing the "CLOCK, SCHEDULE" key twenty-two (22) times, the display will indicate "#1 HOL MONTH = 0". This is the month that the first holiday will be. Use the "+/YES" or "-/NO" keys to change the month (1—12 for January—December or 0 for not used) for the first holiday to required value such as 7 (July) and enter into memory by pressing "=/ENTER" key. Pressing the "CLOCK, SCHEDULE" key again will display "#1 HOL DATE = 0" to indicate on which DATE of the month the holiday is. Use the "+/YES" or "-/NO" keys to change the Date (1—31 for the calendar date) for the first holiday to the required value such as 4 (4th day of month 7—July 4th) and enter into memory by pressing "=/ENTER" key. The MicroTech will then not allow chiller operation on July 4. Additional key presses of "CLOCK, SCHEDULE" will step the operator through Holiday #2 Month and Date to Holiday #14 Month and Date. The programming order of the holiday does not have to be in chronological order.

E. Set-up Options

Set-up Options are used to customize the chiller to the specific job conditions such as Start and Stop timers or to tell the chiller outside system features are present such as a Building Automation System (BAS) or remote Start and Stop. Once the Set-up Options are configured for a unit, they shouldn't have to be altered except for minor changes to options such as tower stage ON/OFF setpoint. All Set-up Options require the OPERATOR password for changes.

1. **RESET OPTIONS.** Possible reset options are none (NONE — no reset of chiller water from local or remote source, and no demand limiting from remote source), reset of leaving chilled water based on return water (Ent), reset of leaving chilled water from remote BAS input signal (ChW), demand limit from remote BAS input (Amp), demand limit from remote BAS input and reset of leaving chilled water based on return water input (AmpEnt), and reset of leaving chilled water from remote BAS input signal and demand limit from remote BAS input (AmpChW).

To change the unit to a different Reset Option, press the "SET-UP OPTIONS" key once to display "RESET OPTIONS = NONE" and to changed use the "+/YES" or "-/NO" key to change, and the "=/ENTER" key to enter Reset type into memory.

2. **MAXIMUM CHILLED WATER RESET.** This is the number of degrees a 20 mAdc BAS input signal will reset the leaving chilled water when Reset Option is programmed to ChW or AmpChW. Pressing the

Set-up Options key twice will display "MAX ChW RESET= 10.0 F" when "RESET OPTION= ChW" to indicate that with a 4 mAdc input signal chilled water will be reset 0.0 degrees and with a 20 mAdc input signal the Reset Leaving Setpoint (see above "Water Temps" section 1.b) will be leaving water set point plus 10 degrees F. See Section II, part A — "Setpoints" for a graphic representation of Reset Setpoint. When Reset Option is not set to ChW or AmpChW, the "MAX ChW RESET = N/A".

To change the "MAX ChW RESET", press the Set-up Option key to display "MAX ChW RESET = 0.0 F" and use the "-/NO" or "+/YES" key to change the value and the "=/ENTER" to enter the value into memory. The minimum values is 0 and maximum is 15.0 F.

3. ENTERING EVAPORATOR SETPOINT. This is the setpoint for entering evaporator water control (when "RESET OPTION = Ent" or "AmpEnt") is being used. To display the current setting, press the "SET-UP OPTIONS" key three times to display "ENT EVAP SPT = 54.0F". This indicates that the chiller is changing leaving evaporator setpoint (Reset Leaving Setpoint) to maintain a constant entering evaporator temperature of 54.0°F.

To change the Entering Evaporator Setpoint, press the "+/YES" or "-/NO" key until a required temperature is displayed and then press the "=/ENTER" key to enter change into memory. The typical setpoint for this value is the design entering evaporator water temperature.

4. ENTERING EVAPORATOR TIMER. This is the amount of time between calculations of the leaving chilled water setpoint when entering water control is being used ("RESET LVG SPT = Ent" or "AmpEnt"). MicroTech checks the actual entering evaporator water temp and compares it to the Entering Evaporator Setpoint (see C. above) and will change the Reset Leaving Setpoint based on the amount of deviation.

To change the current Entering Evaporator Timer setting, press the Set-up Options key four times to display "ENT EVP TIMER= 3Min" and use the "+/YES" or "-/NO" key until a required Time is displayed (2 minutes minimum, 60 minutes maximum) and then press the "=/ENTER" key to enter change into memory.

5. START MODE. The chiller can be controlled to start or stop from a remote contact closure (see field wiring diagrams in Section III). The Start Mode when programmed to "LOCAL" will start and stop based on the STOP/AUTO switch on the panel front and the Time Schedules S1 and S2. If remote Start/Stop is required, press the Set-up Option key five times to display "START MODE = LOCAL" and use the "+/YES" key to change to "START MODE = REMOTE" and the "=/ENTER" key to enter change into memory. The chiller will now operate, Start or Stop, whenever the remote contact or switch is Closed or Opened, respectively. Note: When the Start Mode is set to REMOTE, Time Schedules S1 and S2 can not be used.

SPECIAL NOTE: AUTO-RESTART AFTER POWER FAILURE. The MicroTech control system can be set up to automatically restart after a power failure (assuming all other system components are operable). This can be done two ways:

- a. The time schedules S1 and S2 can be set for continuous operation or as required by the building operating schedule. The startup mode must be set to LOCAL. After a power failure the controller will check the time schedule for a RUN indication, and start the unit if it is in an ON mode.
 - b. Auto restart can also be done when the startup mode is REMOTE. After a power failure, the controller will check the remote Start/Stop for a contact closure, indicating a start requirement. If no remote start signal is being used, a jumper may be installed across terminals 9 and 64. This jumper will simulate the contact closure, meaning the unit will always be in an ON mode.
6. STARTUP DIFFERENTIAL TEMPERATURE. This is temperature difference above leaving evaporator setpoint that will Start the unit after a standard "cooling load satisfied" shutdown. To display the current setting, press the Set-up Options key six times to display "STARTUP D-T = 3.0 F". This indicates that the unit will re-start after the leaving evaporator water temperature reaches 3 degrees above the current chilled water setpoint. The adjustable range is from 1.0 to 10.0 degrees and can be changed by pressing the "+/YES" or "-/NO" keys until the new value is displayed and then pressing the "=/ENTER" key to store the change into memory.
 7. SHUTDOWN DIFFERENTIAL TEMPERATURE. This is temperature difference below the current leaving evaporator setpoint that will stop the unit after satisfying the cooling load. To display the current setting, press the Set-up Options key seven times to display "SHUTDOWN D-T = 4.0 F". This indicates that the unit will shutdown after the leaving evaporator water temperature reaches 4 degrees below the chilled water setpoint. The adjustable range is from 3.0 to 10.0 degrees and can be changed by pressing the "+/YES" or "-/NO" keys until the new value is displayed and then pressing the "=/ENTER" key to store the change into memory.

8. **START-TO-START TIMER.** The start-to-start timer is the required elapsed time between successive starts. To display and change the current setting, press the Set-up Options key eight times to display "START—START= 40Min" and use the "+/YES" or "-/NO" keys to obtain the required value and then press the "=/ENTER" key to store new value into memory. The value of 40 minutes indicates that 40 minutes must elapse before it could be started again. The adjustable range is from 20 to 60 minutes.
9. **STOP-TO-START TIMER.** The stop-to-start timer is the required time the unit must be OFF after a standard shutdown before the unit can be restarted (Start-to-Start timer must also be satisfied). To display and change the current setting, press the Set-up Options key nine times to display "STOP TO START= 5 Min" and use the "+/YES" or "-/NO" keys to obtain the required value and then press the "=/ENTER" key to store new value into memory. The adjustable range is from 3 to 20 minutes.
10. **LOAD DELAY TIMER.** The Load Delay Timer is the amount of time that will elapse before the leaving evaporator water temperature reading is taken after the evaporator pump has started. The timer is factory set for 15 seconds and is adjustable from 15 seconds minimum to 240 seconds maximum. To display and change the current setting, press the Set-up Options key ten times to display "LOAD DELAY = 15Sec" and press the "+/YES" or "-/NO" keys to change.
11. **CONDENSER PUMP START TIMER.** The condenser pump timer is the length of time the condenser pump operates after the end of the oil pump pre-lube and before the compressor starts (energize MCR relays). Use the "+/YES" or "-/NO" to change. Under standard operating conditions, this value should remain at the factory setting.
12. **TOWER STAGE 1 ON.** The MicroTech can operate two tower stages by energizing field supplied and wired Tower Stage Relays (See Certified Field Wiring Diagram in Section III). The ON and OFF control of these relays (Tower stage 1 and 2) is based on a head pressure differential (condensing pressure minus evaporator pressure) and each relay will be energized (Tower Stage ON) when the differential is equal to or greater than the setpoint value. To display and change the current setting, press the Set-up Options key twelve times to display "TWR STG 1 ON= 50PSID" (PSID is PSI Differential) and use the "+/YES" or "-/NO" keys to obtain the new value and "=/ENTER" key to store the change into memory. A value of 50 PSID indicates the output contacts for tower stage one will be closed at head pressure differential (lift) of 50 PSID. The default value is 50 PSID with a minimum differential of 45 PSID and the maximum of 55 PSID.
13. **TOWER STAGE 1 OFF.** The OFF control for Tower Stage 1 is also by differential and can be programmed in a similar as Tower Stage 1. The OFF setpoint value must be set below the Tower Stage 1 ON so that the effect of the tower fan operation does not reduce the differential pressure immediately and cycle the stage OFF. The default value is 40 PSID with a minimum differential of 35 PSID and the maximum of 45 PSID.
14. **TOWER STAGE 2 ON.** Stage 2 ON (Twr Stg Relay 2) of condenser tower control is identical to Stage 1 except default value is 55 PSID with a minimum differential of 50 PSID and the maximum of 60 PSID.
15. **TOWER STAGE 2 OFF.** Stage 2 OFF of condenser tower control is identical to Stage 1 except default value is 45 PSID with a minimum differential of 40 PSID and the maximum of 50 PSID.
16. **ENABLE LAG CHILLER.** On 2 unit applications, the Enable Lag Chiller setpoint is the % RLA required on the operating unit before the second unit is allowed to start. The Starting of the lag unit in this manner assures that the operating unit is adequately loaded prior to starting the lag unit. To display and change the setpoint, press the Set-up Options key until "ENABLE LAG = 95%" appears on the display and use the "+/YES" or "-/NO" keys until the required % RLA is displayed and then press the "=/ENTER" key to enter change into memory. In this case, the next unit will be started when the operating unit reaches 95 % RLA for the "DELAY TIME" of 5 minutes (see below 18. Lag Chiller Delay Timer). The minimum enable value is 80 % RLA and the maximum is 100 % RLA.
17. **DISABLE LAG CHILLER.** On 2 unit applications, this is the required % RLA on the operating units before the lag unit is shut down on load satisfied. The Stopping of the lag unit in this manner assures that one unit can handle the entire load. To display and change the setpoint, press the Set-up Options key until "DISABLE LAG = 40 %" appears on the display and use the "+/YES" or "-/NO" keys until the required % RLA is displayed and then press the "=/ENTER" key to enter change into memory. In this case, the lag unit will be stopped when the operating chillers reach 40 % RLA for the "DELAY TIME" of 5 minutes (see below 18. Lag Chiller Delay Timer). The minimum enable value is 35 % RLA and the maximum is 60 % RLA.

18. LAG CHILLER DELAY TIMER. On multiple unit applications, this is the required time at either Enable RLA setpoint or Disable RLA setpoint before units are started or stopped. To display and change the current setpoint, press the Set-up Options key until "DELAY TIMER = 5 Min" appears on the display. Use the "+/YES" or "-/NO" keys until the required delay time is displayed and then press the "=/ENTER" key to enter change into memory.

For enabling a unit, the lead unit must be at or above 95 % RLA for 5 minutes before the second unit will be started. The minimum delay time is 1 minute and the maximum is 10 minutes.

VII. Lead/Lag-Load/Balance (LLLB) System Controller

A. Dual (PFH) and Two Unit (2 X PEH) Applications

The two unit System Controller (Lead/Lag-Load/Balance panel or LLLB) is a cartridge style controller without an output display or keypad input section. It is connected to each McQuay MicroTech Unit Controller (two MicroTech control panels) via a shielded twisted pair cable (See Figure A for complete configuration of this system).

Figure A.

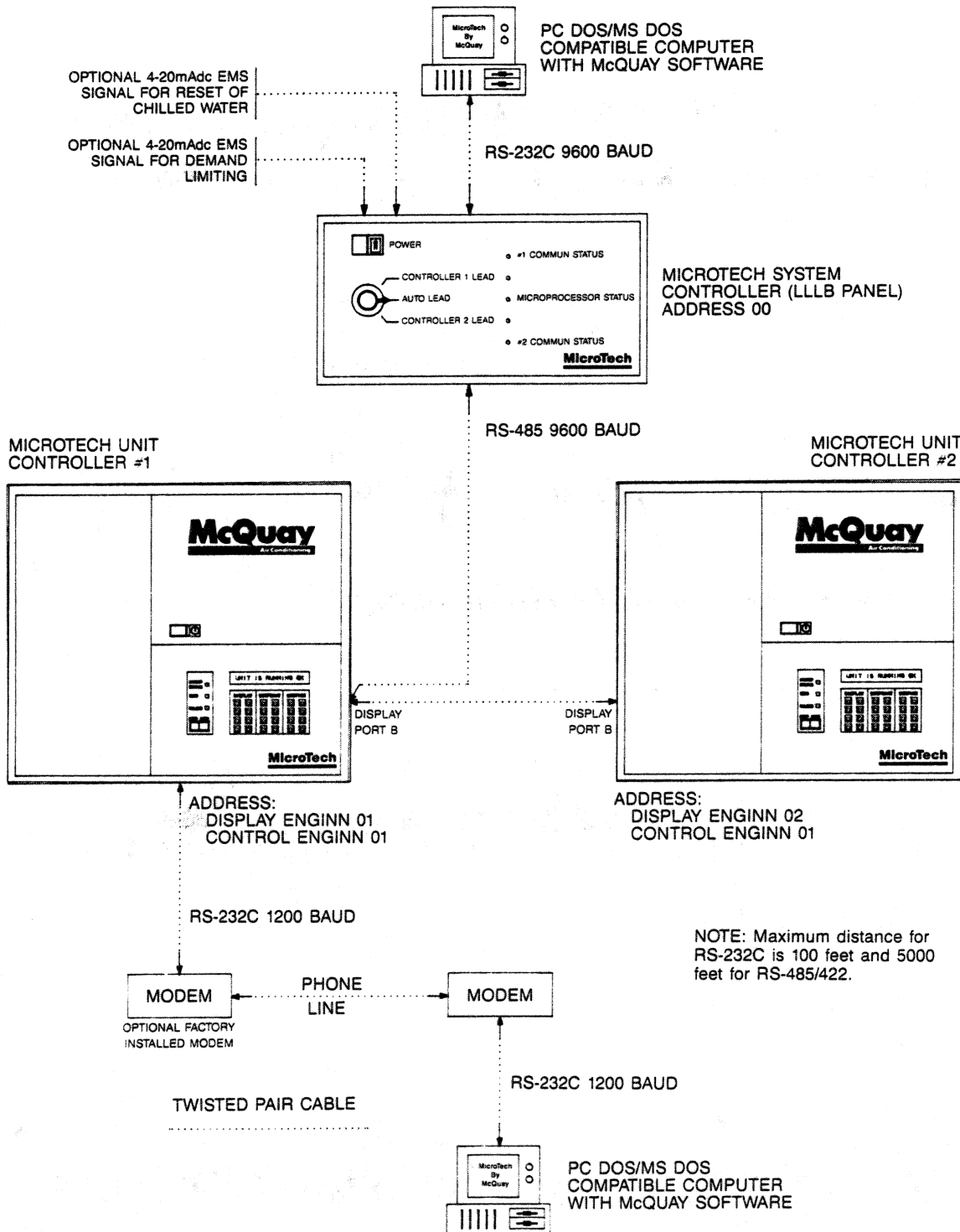

The LLLB controller logic is capable of reading variables from two Unit Controllers and using this information to enable or disable the Unit Controllers. The LLLB controller cannot actually start a compressor—it can only allow the Unit Controller to start or stop a startup sequence. The MicroTech's Unit Controller Stop/Auto switch, time clock/holiday schedule or the remote Stop/Start contacts have the overriding control to "start" the chiller.

For example, if the MicroTech Unit Controller is in a scheduled "OFF" time period on the Clock Schedule, the unit will remain OFF until chiller's time clock is in an "ON" period and the enable signal from the System Controller (LLLB) is received.

B. Lead/Lag Operation

The LLLB is designed to automatically dedicate the unit/compressor with the fewest operating hours to be started first (lead) and then cycle the second (lag) unit/compressor when the cooling load requires operation of the second unit/compressor. Lag unit/compressor operation is assured by first loading the lead unit/compressor to its full capacity (user programmable based on % full load amps) for a specific time period (user programmable) before starting the lag unit/compressor. When the system load decreases to a point where a single unit/compressor is able to satisfy cooling requirements, the LLLB Controller will shut off the unit with the most operating hours (See Figure B).

Figure B.

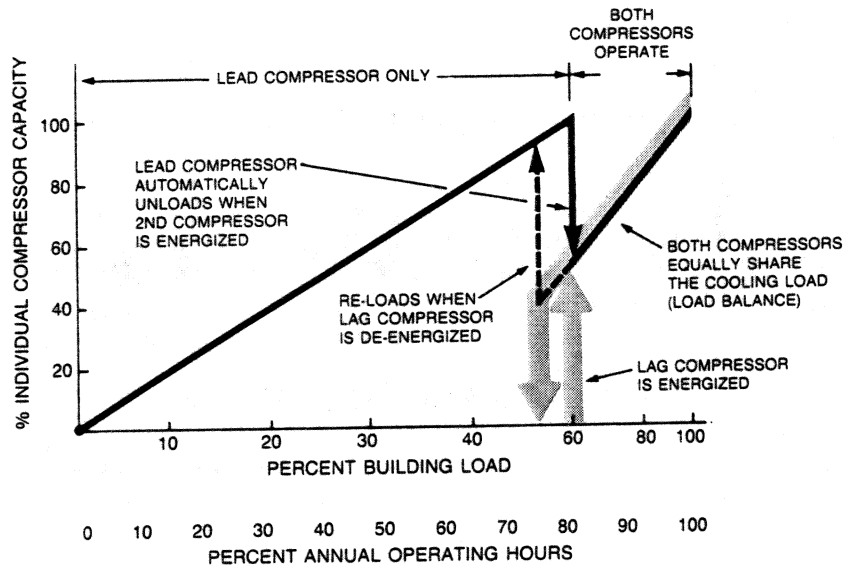

Automatic selection of "LEAD" compressor is obtained by positioning the Lead/Lag/Auto switch located on the LLLB panel front to the Auto position. It is the operators option to also select the "LEAD" unit/compressor by moving this switch to the "Unit (Controller) #1 Lead" position or "Unit (Controller) #2 Lead" position.

The three control variables associated with the LLLB Controller are:

ENABLE / RLA: This is the percentage of Rated Load Amps (RLA) which is required on the lead chiller before the lag chiller is brought on-line. The default value is 95% and is adjustable from 80% to 100%.

DISABLE / RLA: This is the percentage of Rated Load Amps (RLA) which must be maintained on both chillers before the lag chiller is cycled off (lag chiller is unit/compressor with the highest elapsed hours of operation when selector switch is in "Auto" position). The default value is 45% and is adjustable from 35% to 70%.

TIME DELAY: This is the elapsed time the unit(s) % RLA must be at or above the Enable % RLA or at or below Disable % RLA setpoints before a unit is started or stopped, respectively. The default value is 5 minutes and is adjustable from 1 to 10 minutes. The lead unit, for example, must be at or above 95% RLA for 5 minutes before the lag unit is started.

These values are adjustable by the operator, and are found under the Set-up Options key on each MicroTech Unit Controller (see Section IV, Displayed Values and Setpoints, Part C, Fifth key, 15 through 17th key press). **Note:** The information used by the LLLB Controller is obtained from the #1 unit/compressor it is therefore advisable to set these values in unit/compressor #2 to identical values to eliminate confusion.

C. Automatic Startup on Safety Shutdown

In the case of a safety shutdown of lead unit/compressor, the lag unit/compressor will be automatically brought on line if it was OFF (automatic starting of backup unit) or continue to operate the functional unit/compressor if it had been in operation.

D. Load Balance Operation

The Load Balance feature of the LLLB Controller equally divides the cooling capacity and power consumption between the two compressors. Together, they consume less power than two independent non-load-balanced chillers. In addition to saving energy, the Load Balance feature prevents excessive cycling of the Lag compressor. Without Load Balance, the Lead compressor would be fully loaded when the Lag compressor starts. The load would be quickly satisfied, and the lag compressor would cycle off. With the superior control of the LLLB, the controller unloads the Lead unit/compressor before starting the lag, allowing both compressors to load equally until compressor loading matches system requirements.

The System Controller is designed to allow a 5% difference in the two units % RLA and will unload the unit with 5% higher RLA and in effect load the unit with less amps to keep each within 5% of the other.

E. Field Connection and EMC Interface

The LLLB Controller has the capability to reset the leaving chilled water and demand limit both units/compressors by inputting a single value for each function into the LLLB Controller. The use of an external Energy Management Signal (EMS) or Building Automation Signal (BAS) must be programmed into Unit/Compressor #1's "Set-up Options" key under the "Reset Options" function (see Section IV, Displayed Values and Setpoints, Part C, Fifth key, 1st key press). This will pass upward from the Unit Controller to the LLLB Controller that there is reset from a remote EMS. The different types of Reset and Demand Limiting are (programmed into Unit/Controller #1):

NONE: No reset methods or demand limiting functions are enabled.

AMP: Remote input signal (4-20mA DC) to the LLLB is to demand limit both units/compressors. Limiting shall be based on schedule in Section IV, Setpoint key "MAX AMP LIMIT".

ChW: Remote input signal (4-20mA DC) to the LLLB is to be used to reset the leaving evaporator setpoint on both units/compressors. Reset shall be based on schedule in Section IV, Setpoint key "WATER TEMP'S".

ENT: Reset of chilled water (return water control) shall be enabled. See Section IV, Setpoint key "WATER TEMP'S". No EMS/BAS signal required.

AMPENT: Remote input signal (4-20mA DC) to the LLLB is to demand limit the chiller and the reset from return water (return water control) will be enabled.

AMPChW: Remote input signals (4-20mA DC) into the LLLB are to demand limit the chiller and reset leaving chilled water on both units.

See Section III for field wiring diagram of LLLB panel

F. Panel Configuration

The LLLB Controller panel front contains the following items:

- **LEAD/LAG/AUTO SWITCH:** The three position rotary switch is designed to be in one of two modes at all times—AUTO Lead/Lag or Manual position of Lead. With the switch positioned to AUTO, the LLLB Controller will determine the correct unit to be lead based on the total elapsed time on each MicroTech

Unit Controller. In the Manual position with Controller 1 Lead or Controller 2 Lead, the given unit will always cycle first and balance remaining cooling capacity with the other controller.

- **COMMUNICATION STATUS LIGHT:** Controller 1 & 2 each have dedicated LED lights that indicate, in blinking watch-dog fashion, that the twisted pair communication between each Unit Controller and the LLLB are in proper working condition.
- **MICROPROCESSOR STATUS LIGHT:** Blinking light that indicates the internal components (memory, communication logic, etc.) and the control program are in proper working condition. This light, as with the Communication Status light and the Microprocessor Status light on each MicroTech Unit Controller, should always be flashing in a slow steady manner to indicate "All Systems GO".
- **CONTROLLER LEAD LIGHT:** Indicates which unit/compressor is in lead.
- **POWER SWITCH:** This controls the power being fed to the LLLB panel and when "off" will disable all Lead/Lag-Load/Balancing controls so each unit/compressor will operate and cycle independently.

G. Special Considerations

For all 2 unit/compressor applications, the information used to start and stop a unit is stored in Unit Controller #1. The Enable % RLA, Disable % RLA, and Time Delay used by the LLLB Controller is from the #1 MicroTech Unit Controller. It is advisable to set these parameters in the #2 Controller to identical values to eliminate confusion. Unit/Compressor Controller and LLLB Controller can be identified or set by changing the HI-LOW controller identification pots to each of the following:

	HI	LOW
HI-LOW value of Unit/Compressor #1 Display Enginn:	0	1
HI-LOW value of Unit/Compressor #1 Control Enginn:	0	1
HI-LOW value of Unit/Compressor #2 Display Enginn:	0	2
HI-LOW value of Unit/Compressor #2 Control Enginn:	0	1
HI-LOW value of LLLB Controller :	0	0

For MicroTech Clock Schedule, Holiday Schedule, Manual Stop/Auto switch, and Remote Stop/Start, each function is still active in each Unit Controller. For example, if Unit #1 were lead with the Lead/Lag/Auto switch in the Auto position but the Stop/Auto switch on the MicroTech panel were in the OFF position, Unit #2 would operate as if it were the lead unit and unit #1 would remain off. It is advisable to program both MicroTech Unit Controllers so that they have identical time schedules and holiday schedules in order to eliminate any possible confusion.

