

PowerFlex 750-Series AC Drives



LISTEN.
THINK.
SOLVE.™

Table of Contents

Product Overview	3
Catalog Number Explanation	4
PowerFlex 750-Series Drive Family	5
Certifications	6
Environmental Specifications	6
Technical Specifications	8
Design Considerations	9
Input Voltage Tolerance	9
Approximate Watts Loss	10
Derating Guidelines	11
Minimum Dynamic Brake Resistance	20
Fuse and Circuit Breaker Ratings	21
Cable Considerations	26
Wiring Considerations	26
Motor Considerations	27
Allen-Bradley Permanent Magnet Servo Motors	28
Dimensions and Weights	30
Frame/Rating Cross-Reference	30
Enclosure Options	30
Minimum Mounting Clearances	31
Approximate Dimensions	33
Drive Options	54
Human Interface and Wireless Interface Modules	54
Communication Option Kits and Accessories	55
Feedback Options	59
I/O Option Kits	59
Safety Options	59
PowerFlex 750-Series Option Kits	61
Internal Dynamic Brake Resistor Kits	61
Dynamic Brake, Chopper Only Kits	61
Terminators	62
Reflected Wave Reduction Modules w/Common Mode Choke	62
Isolation Transformers	63
Input and Output Line Reactors	64

Summary of Changes

The information below summarizes the changes since the last release.

Change
Permanent Magnet Servo Motor information updated on pages 28 and 29 .

Reference Materials

For additional PowerFlex 750-Series data and general drive information, refer to the following publications.

Title	Publication	Available Online at ...
PowerFlex 750-Series Drive Installation Instructions	750-IN001	www.rockwellautomation.com/literature
PowerFlex 750-Series Programming Manual	750-PM001	
Enhanced PowerFlex 7-Class Human Interface Module (HIM) User Manual	20HIM-UM001	
PowerFlex 750-Series Safe Torque Off User Manual	750-UM002	
Safe Speed Monitor Option Module for PowerFlex 750-Series AC Drives Reference Manual	750-RM001	
PowerFlex 7-Class Network Communication Adapter User Manuals	750COM-UM	
Dynamic Braking Resistor Calculator	PFLEX-AT001	
Wiring and Grounding Guidelines for PWM AC Drives	DRIVES-IN001	
Preventive Maintenance of Industrial Control and Drive System Equipment	DRIVES-TD001	
Safety Guidelines for the Application, Installation and Maintenance of Solid State Control	SGL-1.1	

Product Overview

The PowerFlex 750-Series is a robust family of AC drives that provide ease of use, flexibility, and performance for a variety of industrial applications. The PowerFlex 753 provides general purpose control for applications ranging up to 350 Hp and 250 kW. The PowerFlex 755 provides maximum flexibility and performance ranging up to 700 Hp and 450 kW.

Maximize your productivity by taking advantage of the following key features offered in the PowerFlex 750-Series:

- **DeviceLogix™** – Embedded control technology that supports the manipulation of discrete outputs and drive control functions, while using discrete inputs and drive status information onboard the drive.
- **Predictive Diagnostics** – Allows the drive to keep track of information that affects the life of its cooling fans and relay outputs. The drive can also be programmed to monitor the run time hours for machine or motor bearings.
- **Option Cards** – Each drive has a slot-based architecture. Supported hardware control options are common for both products, to help reduce your inventory and spare parts requirements.
- **Safe Torque-Off and Safe Speed Monitor** – provides a choice for safety levels depending on your application requirements.
- **Communications** – The PowerFlex 755 comes with a built-in Ethernet port. Ethernet can easily be added to the PowerFlex 753 with a communication module.
- **I/O** – option cards are available for additional analog and discrete I/O. The PowerFlex 753 comes with built-in I/O that can also be easily expanded with option cards.
- **Packaging** – Factory and field installable enclosure options are available to meet most environmental requirements: Open Type and Flange Mount options to support Cabinet Mount requirements, Extra Protection Wall Mount for harsh environments, and supporting debris hoods and conduit plate kits.
- **Standard Power Structure** – a common power structure is shared to provide the same physical footprint and power range no matter what PowerFlex 750 -Series drive is used.



Catalog Number Explanation

Position

1...3 4 5 6 7 8...10 11 12 13 14 15 16 17 18

20G 1 A N D 248 A A 0 N N N N N - LD - P3 - P11...

a b c d e f1...f2 g h

Cabinet Options (21G)

a

Drive	
Code	Type
20F	PowerFlex 753
20G	PowerFlex 755
21G	PowerFlex 755 Drive w/Cabinet Options

b

Future Use	

c

Input Type *		
Code	Description	Frames
1	AC & DC Input w/Precharge	2...5
4	DC Input w/Precharge	5...7
A	AC Input w/Precharge, no DC Terminals	6...8

* For Frames 2...4, Code 1 also provides the functionality of DC input with Precharge. For Frames 5 and larger, Code 4 is required for DC input with Precharge. The optional DC Bus Bar kit (20-750-DCBB1-Fx) is available for Frame 6 & 7 AC input drives requiring DC bus terminals.

d

Enclosure		
Code	Description	Frames
B	IP20, NEMA/UL Type 1, 2500 MCC Style Cabinet, 600 mm (23.6 in.) Deep	8
F ‡	Flange (NEMA/UL Type 4X back)	2...5
G	IP54, NEMA/UL Type 12	2...7
L	IP20, NEMA/UL Type 1, 2500 MCC Style Cabinet, 800 mm (31.5 in.) Deep	8
N ✱	IP20/IP00, NEMA/UL Type Open	2...7
P ✱	IP20, NEMA/UL Type 1, 2500 MCC Style Cabinet & Option Bay w/MCC Power Bus, 800 mm (31.5 in.) Deep	8

‡ For Frames 6...7 a User Installed Flange Kit is available to convert a Code N drive that provides a NEMA/UL Type 4X back.

✱ Frames 2...5 are IP20, Frames 6...7 are IP00.

✱ Available as a drive w/Cabinet Options (21G). MCC power bus is not UL listed.

e

Voltage Rating	
Code	Voltage
C	400V AC
D	480V AC

f1

ND Rating								
400V, 50 Hz Input								
Code	Amps	kW	Frame					
			Enclosure Code					
			B	F	G	L	N	P
2P1	2.1	0.75						
3P5	3.5	1.5						
5P0	5.0	2.2						
8P7	8.7	4		2	2		2	
011	11.5	5.5						
015	15.4	7.5						
022	22	11						
030	30	15						
037	37	18.5						
043	43	22						
060	60	30	-	4	4	-	4	-
072	72	37						
085	85	45						
104	104	55		5			5	
140	140	75						
170	170	90			6		6	
205	205	110						
260	260	132						
302	302	160		‡				
367	367	200			7		7	
456	456	250						
460	460	250						
540	540	315						
567	567	315	8			8		8 ✱
650	650	355						
750	750	400						
770	770	400						

‡ For Frames 6...7 a User Installed Flange Kit is available to convert a Code N drive that provides a NEMA/UL Type 4X back.

✱ Available as a drive w/Cabinet Options (21G). MCC power bus is not UL listed.

f2

ND Rating								
480V, 60 Hz Input								
Code	Amps	Hp	Frame					
			Enclosure Code					
			B	F	G	L	N	P
2P1	2.1	1						
3P4	3.4	2						
5P0	5.0	3						
8P0	8.0	5		2	2		2	
011	11	7.5						
014	14	10						
022	22	15						
027	27	20						
034	34	25						
040	40	30						
052	52	40	-	4	4	-	4	-
065	65	50						
077	77	60						
096	96	75		5			5	
125	125	100						
156	156	125			6		6	
186	186	150						
248	248	200						
302	302	250		‡				
361	361	300			7		7	
415	415	350						
430	430	350						
485	485	400						
545	545	450	8			8		8 ✱
617	617	500						
710	710	600						
740	740	650						

‡ For Frames 6...7 a User Installed Flange Kit is available to convert a Code N drive that provides a NEMA/UL Type 4X back.

✱ Available as a drive w/Cabinet Options (21G). MCC power bus is not UL listed.

g

Filtering and CM Cap Configuration >		
Code	Filtering	Default CM Cap Connection
A	Yes	Jumper Removed
J	Yes	Jumper Installed

> 480V drives must select code "A." Jumpers are included for field reconfiguration as desired.

h

Dynamic Braking ✱		
Code	Internal Resistor ‡	Internal Transistor †
A	No	Yes
N	No	No

‡ Frame 2 only.

† Standard on Frames 2...5, optional on 6...7.

✱ Not available on Frame 8, specify Code "N."

PowerFlex 755 w/Cabinet Options (21G) - Required Selections

Code	Option	Type
LD	Light Duty	System Overload Duty Cycle *
ND	Normal Duty	
HD	Heavy Duty	
P3	Input Thermal Magnetic Circuit Breaker	Power Disconnect or Wiring Only Bay *
P5	Input Non-Fused Molded Case Disconnect Switch	
P14	Wiring Only Bay	

* Only one option of this type may be selected.

PowerFlex 755 w/Cabinet Options (21G) - Additional Selections

Code	Option	Type
P11	Input Contactor	Contactors *
P12	Output Contactor	
L1	3% Input Reactor	Reactors *
L2	3% Output Reactor	
L3	5% Input Reactor	
L4	5% Output Reactor	
P20	1250 Amp Bus	MCC Power Bus Capacity *
P22	2000 Amp Bus	
P24	3200 Amp Bus	

* Only one option of this type may be selected.

‡ Contactor options are not available for systems with MCC power bus.

PowerFlex 750-Series Drive Family



Frame 2...7
IP00/IP20, NEMA/UL Type Open Drive

- includes:
- DC link choke
 - Internal brake transistor standard on Frames 2...5 and optional on Frames 6...7

Frame 8
IP20, NEMA/UL Type 1 Drive (2500 MCC Style Cabinet)

- includes:
- DC link choke
 - AC line fuses
 - Roll-out design





Frame 8
IP20, NEMA/UL Type 1 Drive and Cabinet Options (2500 MCC Style Cabinet)

- includes:
- DC link choke
 - AC line fuses
 - Roll-out design
 - Option bay for control/protection devices



- Roll-out Cart
- Required for Frame 8 drives
 - Adjustable Curb Height: 0...182 mm (0...7.2 in.)
 - Adjustment for Curb Offset/Reach: 0...114 mm (0...4.5 in.)

Certifications

	Listed to UL508C and CAN/CSA-C22.2 No. 14-05 (does not apply to 21G drives with enclosure code "P").
	In conformity with the following European Directives: EMC Directive (2004/108/EC) Low Voltage Directive (2006/95/EC) Standards applied: EN 61800-3:2004 EN 61800-5-1:2007
	TÜV Rheinland Certification applies to 20-750-S and 20-750-S1 Safety Options when installed in drive. Standards applied: EN 61800-3:2004 EN 61800-5-1:2007 EN ISO 13849-1:2008 EN ISO 13849-2:2003 EN 61800-5-2:2007 EN 61508 PARTS 1-7:2000 EN 62061:2005 EN 60204-1:2006
	Australian Communications and Media Authority In conformity with the following: Radiocommunications Act: 1992 Radiocommunications Standard: 2008 Radiocommunications Labelling Notice: 2008 Standards applied: EN 61800-3:2004
EPRI/SEMI F47	Electric Power Research Institute Certified compliant with the following standards: SEMI F47 IEC 61000-4-34
GOST-R	Russian GOST-R Certificate no. POCC US.ME92.H00040

Environmental Specifications

Category	Specification																				
Altitude: Based on Load: Based on Voltage:	See Derating Guidelines on pages 11 ... 19 . <table border="1" data-bbox="521 1465 1430 1619"> <thead> <tr> <th>System & Ground Configuration</th> <th>Overvoltage Category⁽¹⁾</th> <th>Voltage</th> <th>Altitude Limit⁽²⁾</th> </tr> </thead> <tbody> <tr> <td>Center Grounded (Y Neutral) w/Solid Ground</td> <td>II (2)</td> <td>Up to 480V AC</td> <td>9000 m above sea level⁽³⁾</td> </tr> <tr> <td></td> <td>III (3)</td> <td>Up to 480V AC</td> <td>4800 m above sea level</td> </tr> <tr> <td>Ungrounded, Impedance</td> <td>II (2)</td> <td>Up to 480V AC</td> <td>4800 m above sea level</td> </tr> <tr> <td>Grounded, or Corner Grounded</td> <td>III (3)</td> <td>Up to 480V AC</td> <td>2000 m above sea level</td> </tr> </tbody> </table> <p>Notes: Based on EN61800-5-1 (Electro-thermal Safety Standard for drives)</p> <p>⁽¹⁾ Overvoltage Categories: Category II (Isolation Transformer Level) - Typically two levels of isolation or protection from outdoor power lines. Category III (Most Common) Distribution Level Inside a Building - Typically one level of isolation or protection from outdoor power lines.</p> <p>⁽²⁾ Excluding failure from cosmic radiation. Cosmic radiation will increase rate of IGBT malfunction at altitudes greater than 3000 m above sea level. Concrete walls and ceilings or concrete walls and large bottles of water overhead are examples of ways to shield against cosmic radiation.</p> <p>⁽³⁾ Drive is limited to a maximum of 4800 m thermally. Refer to the Ambient Temperature/Load Derating Guidelines starting on page 11.</p>	System & Ground Configuration	Overvoltage Category ⁽¹⁾	Voltage	Altitude Limit ⁽²⁾	Center Grounded (Y Neutral) w/Solid Ground	II (2)	Up to 480V AC	9000 m above sea level ⁽³⁾		III (3)	Up to 480V AC	4800 m above sea level	Ungrounded, Impedance	II (2)	Up to 480V AC	4800 m above sea level	Grounded, or Corner Grounded	III (3)	Up to 480V AC	2000 m above sea level
System & Ground Configuration	Overvoltage Category ⁽¹⁾	Voltage	Altitude Limit ⁽²⁾																		
Center Grounded (Y Neutral) w/Solid Ground	II (2)	Up to 480V AC	9000 m above sea level ⁽³⁾																		
	III (3)	Up to 480V AC	4800 m above sea level																		
Ungrounded, Impedance	II (2)	Up to 480V AC	4800 m above sea level																		
Grounded, or Corner Grounded	III (3)	Up to 480V AC	2000 m above sea level																		

Category	Specification																								
Maximum Surrounding Air Temperature without De-rating																									
IP20, NEMA/UL Open Type:	0...50 °C (32...122 °F) Frame 2...5, All Ratings																								
IP00, NEMA/UL Open Type:	0...50 °C (32...122 °F) Frame 6...7, All Ratings																								
IP20, NEMA/UL Type 1 (w/Hood):	0...40 °C (32...104 °F) Frame 2...5, All Ratings																								
IP20, NEMA/UL Type 1 (w/Label):	0...40 °C (32...104 °F) Frame 6...7, All Ratings																								
IP20, NEMA/UL Type 1 (MCC Cabinet):	0...40 °C (32...104 °F) Frame 8, All Ratings																								
Flange Mount –																									
Front:																									
IP20, NEMA/UL Open Type:	0...50 °C (32...122 °F) Frame 2...5, All Ratings																								
IP00, NEMA/UL Open Type:	0...50 °C (32...122 °F) Frame 6...7, All Ratings																								
Back/Heat Sink:																									
IP66, NEMA/UL Type 4X	0...40 °C (32...104 °F) Frame 2...7, All Ratings																								
Stand-alone/Wall Mount –																									
IP54, NEMA/UL Type 12	0...40 °C (32...104 °F) Frame 2...7, All Ratings																								
Storage Temperature (all const.):	-40...70 °C (-40...158 °F)																								
Atmosphere:	Important: Drive must not be installed in an area where the ambient atmosphere contains volatile or corrosive gas, vapors or dust. If the drive is not going to be installed for a period of time, it must be stored in an area where it will not be exposed to a corrosive atmosphere.																								
Relative Humidity:	5...95% non-condensing																								
Shock - Operating	Frame 2...6: 15 g peak for 11 ms duration (±1.0 ms) Frame 7: 10 g peak for 11 ms duration (±1.0 ms) Frame 8: Power Core - 10 g peak for 11 ms duration (±1.0 ms) in Cabinet w/Option Bay - 5 g peak for 11 ms duration (±1.0 ms)																								
Shock - Packaged for Shipment	Frame 2: 381 mm (15 in.) drop height Frame 3...4: 330 mm (13 in.) drop height Frame 5: 305 mm (12 in.) drop height Frame 6...8: Meets International Safe Transit Association (ISTA) test procedure 2B																								
Vibration - Operating	Frame 2: 1.000 mm (0.040 in.) displacement, 2 g peak Frame 3...5: 1.000 mm (0.040 in.) displacement, 1.5 g peak Frame 6...7: 1.000 mm (0.040 in.) displacement, 1 g peak Frame 8: Power Core, Drive in Cabinet w/Option Bay - 1.000 mm (0.040 in.) displacement, 1 g peak																								
Vibration - Packaged for Shipment																									
Sinusoidal Loose Load:	Frame 2...5: 20.0 mm (0.8 in.) peak to peak, 2...5.186 Hz; 1.1 g peak from 5.186...20 Hz Frame 6...8: Meets ISTA 2B packaging standards																								
Random Secured:	Frame 2...5: <table border="1"> <thead> <tr> <th>Frequency (Hz)</th> <th>PSD (g²/Hz)</th> </tr> </thead> <tbody> <tr><td>1</td><td>0.00005</td></tr> <tr><td>4</td><td>0.01</td></tr> <tr><td>16</td><td>0.01</td></tr> <tr><td>40</td><td>0.001</td></tr> <tr><td>80</td><td>0.001</td></tr> <tr><td>200</td><td>0.00001</td></tr> </tbody> </table>	Frequency (Hz)	PSD (g ² /Hz)	1	0.00005	4	0.01	16	0.01	40	0.001	80	0.001	200	0.00001										
Frequency (Hz)	PSD (g ² /Hz)																								
1	0.00005																								
4	0.01																								
16	0.01																								
40	0.001																								
80	0.001																								
200	0.00001																								
	Frame 6...8 Meets International Safe Transit Association (ISTA) test procedure 2B																								
Sound:	<table border="1"> <thead> <tr> <th>Frame</th> <th>Fan Speed</th> <th>Sound Level</th> </tr> </thead> <tbody> <tr><td>2</td><td>50 CFM</td><td>63 dB</td></tr> <tr><td>3</td><td>80 CFM</td><td>64 dB</td></tr> <tr><td>4</td><td>160 CFM</td><td>72 dB</td></tr> <tr><td>5</td><td>260 CFM</td><td>77 dB</td></tr> <tr><td>6</td><td>252 CFM</td><td>73 dB</td></tr> <tr><td>7</td><td>252 CFM</td><td>74 dB</td></tr> <tr><td>8</td><td>1350 CFM</td><td>79 dB</td></tr> </tbody> </table> <p>Note: Sound pressure level is measured at 2 meters.</p>	Frame	Fan Speed	Sound Level	2	50 CFM	63 dB	3	80 CFM	64 dB	4	160 CFM	72 dB	5	260 CFM	77 dB	6	252 CFM	73 dB	7	252 CFM	74 dB	8	1350 CFM	79 dB
Frame	Fan Speed	Sound Level																							
2	50 CFM	63 dB																							
3	80 CFM	64 dB																							
4	160 CFM	72 dB																							
5	260 CFM	77 dB																							
6	252 CFM	73 dB																							
7	252 CFM	74 dB																							
8	1350 CFM	79 dB																							
Surrounding Environment Pollution Degree	(See page 30 for descriptions of each pollution degree rating.)																								
Pollution Degree 1 & 2:	All enclosures acceptable.																								
Pollution Degree 3 & 4:	Enclosure that meets or exceeds IP54, NEMA/UL Type 12 required.																								

Technical Specifications

Category	Specification	380/400	480V	500V	600V	690V
Protection	Drive					
	AC Input Overvoltage Trip:	576V AC	576V AC			
	AC Input Undervoltage Trip:	250V AC	300V AC			
	Bus Overvoltage Trip:	815V DC	815V DC			
	Bus Undervoltage Shutoff: Frames 2...7: Frame 8:	200V DC 300V DC	200V DC 300V DC			
	Nominal Bus Voltage (Full Load):	540V DC	648V DC			
	Drive Overcurrent Trip Software Overcurrent Trip: Instantaneous Current Limit: Hardware Overcurrent Trip:	200% of drive rated 100% of 3 sec. rating (158...210%) 143% of 3 sec. rating (215...287%)				
	Line transients:	up to 6000 volts peak per IEEE C62.41-1991				
	Control Logic Noise Immunity:	Showering arc transients up to 1500V peak				
	Power Ride-Thru:	15 milliseconds at full load				
	Logic Control Ride-Thru:	0.5 seconds minimum, 2 seconds typical				
	Ground Fault Trip:	Phase-to-ground on drive output				
	Short Circuit Trip:	Phase-to-phase on drive output				
	Electrical	AC Input Voltage Tolerance:	See page 9 for full power and operating range.			
Frequency Tolerance:		47...63 Hz.				
Input Phases:		Three-phase input provides full rating for all drives. Single-phase operation provides up to 50% (40% for Frame 8) of rated current at 25 °C (77 °F) surrounding temperature.				
DC Input Voltage Tolerance:		±10% of Nominal Bus Voltage (above)				
Displacement Power Factor:		0.98 across entire speed range.				
DC Link Impedance:		≥ 5%				
Efficiency:		97.5% at rated amps, nominal line volts.				
Maximum Short Circuit Rating:		200,000 Amps RMS symmetrical (20F & 20G drives only)				
Actual Short Circuit Rating:		Determined by AIC rating of installed fuse/circuit breaker.				
Maximum Drive to Motor Power Ratio:		Recommended not greater than 2:1 ratio.				
Battery:	CR1220, 4.5 years unpowered, lifetime powered.					
Control	Method:	Sine coded PWM with programmable carrier frequency. Ratings apply to all drives. The drive can be supplied as 6 pulse.				
	Carrier Frequency:	Default Settings: Drive Frame 2...4: 4 kHz Drive Frame 5...8: 2 kHz Settings: Drive Frame 2...6: 2, 4, 8, 12 kHz Drive Frame 7: 2, 4, 8 kHz Drive Frame 8: 2, 4 kHz				
	Output Voltage Range:	0 to rated motor voltage				
	Output Frequency Range:	0...325 Hz @ 2 kHz carrier 0...650 Hz @ 4 kHz carrier				
	Frequency Accuracy Digital Input: Analog Input:	Within ±0.01% of set output frequency. Within ±0.4% of maximum output frequency.				
	Frequency Control:	Speed regulation - with Slip Compensation (V/Hz & Sensorless Vector modes) 0.5% of base speed across 40:1 speed range, 40:1 operating range				
	Speed Control:	without feedback (Flux Vector mode), 0.1% of base speed across 100:1 speed range, 120:1 operating range, 50 rad/sec bandwidth with feedback (Flux Vector mode), 0.001% of base speed across 100:1 speed range, 1000:1 operating range, 190 rad/sec bandwidth				
	Torque Regulation:	without feedback (Flux Vector mode), ±5%, 600 rad/sec bandwidth with feedback (Flux Vector mode), ±2%, 2500 rad/sec bandwidth				

Category	Specification	
Control <i>(continued)</i>	Selectable Motor Control:	- Standard V/Hz with full custom capability. - Sensorless Vector with full tuning. - Flux Vector with and without a feedback device. - Induction and Permanent magnet motor control.
	Stop Modes:	Multiple programmable stop modes including - Ramp, Coast, DC-Brake, Ramp-to-Hold, Fast Braking, and Current Limit Stop.
	Accel/Decel:	Two independently programmable accel and decel times. Each time may be programmed from 0 to 3600 seconds in 0.1 second increments (0 to motor nameplate speed).
	S Curve Time	Adjustable from 0 to 100% of ramp time (normal duty rating).
	Intermittent Overload:	
	Light Duty (Frame 8 Only)	110% Overload capability for up to 1 minute out of 10 minutes
	Normal Duty	110% Overload capability for up to 1 minute out of 10 minutes 150% Overload capability for up to 3 seconds out of 60 seconds
Heavy Duty	150% Overload capability for up to 1 minute out of 10 minutes 180% Overload capability for up to 3 seconds out of 60 seconds	
Current Limit Capability:	Proactive Current Limit programmable from 20 to 160% of rated output current. Independently programmable proportional and integral gain.	
Electronic Motor Overload Protection:	Class 10 protection with speed sensitive response. Complies with N.E.C. Article 430. U.L. File E59272, volume 12.	

Design Considerations

Input Voltage Tolerance

Drive Rating	Nominal Line Voltage	Nominal Motor Voltage	Drive Full Power Range	Drive Operating Range
380...480	380	380	380...528	342...528
	400	400	400...528	
	480	460	460...528	
Drive Full Power Range =	Nominal Motor Voltage to Drive Rated Voltage + 10%. Rated current is available across the entire Drive Full Power Range			
Drive Operating Range =	Lowest Nominal Motor Voltage - 10% to Drive Rated Voltage + 10%. Drive Output is linearly derated when Actual Line Voltage is less than the Nominal Motor Voltage			

Example:

Calculate the maximum power of a 5 Hp, 460V motor connected to a 480V rated drive supplied with 342V Actual Line Voltage input.

- Actual Line Voltage / Nominal Motor Voltage = 74.3%
- $74.3\% \times 5 \text{ Hp} = 3.7 \text{ Hp}$
- $74.3\% \times 60 \text{ Hz} = 44.6 \text{ Hz}$

At 342V Actual Line Voltage, the maximum power the 5 Hp, 460V motor can produce is 3.7 Hp at 44.6 Hz.

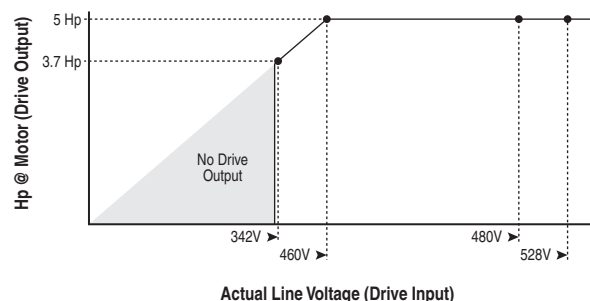

Approximate Watts Loss

400V						480V					
Drive Catalog Number ⁽¹⁾⁽²⁾	Normal Duty		External Watts	Internal Watts	Total Watts	Drive Catalog Number ⁽¹⁾⁽²⁾	Normal Duty		External Watts	Internal Watts	Total Watts
	kW	Cont. Output Amps					Hp	Cont. Output Amps			
20x...C2P1	0.75	2.1	16	55	71	20x...D2P1	1.0	2.1	17	60	77
20x...C3P5	1.5	3.5	26	57	83	20x...D3P4	2.0	3.4	27	61	88
20x...C5P0	2.2	5	39	58	97	20x...D5P0	3.0	5	41	63	104
20x...C8P7	4.0	8.7	75	64	139	20x...D8P0	5.0	8	71	68	139
20x...C011	5.5	11.5	108	70	178	20x...D011	7.5	11	108	74	182
20x...C015	7.5	15.4	161	80	241	20x...D014	10	14	149	81	230
20x...C022	11	22	225	86	311	20x...D022	15	22	237	91	328
20x...C030	15	30	300	103	403	20x...D027	20	27	273	101	374
20x...C037	18.5	37	362	115	477	20x...D034	25	34	368	115	483
20x...C043	22	43	505	126	631	20x...D040	30	40	503	126	629
20x...C060	30	60	487	130	617	20x...D052	40	52	422	125	547
20x...C072	37	72	615	147	762	20x...D065	50	65	559	144	703
20x...C085	45	85	705	162	867	20x...D077	60	77	646	158	804
20x...C104	55	104	928	201	1129	20x...D096	75	96	855	189	1044
20x...C140	75	140	1239	319	1558	20x...D125	100	125	1109	299	1408
20x...C170	90	170	1381	300	1681	20x...D156	125	156	1299	294	1593
20x...C205	110	205	1893	381	2274	20x...D186	150	186	1718	358	2076
20x...C260	132	260	2449	502	2951	20x...D248	200	248	2384	492	2876
20x...C302	160	302	2566	461	3027	20x...D302	250	302	2704	491	3195
20x...C367	200	367	3322	586	3908	20x...D361	300	361	3409	606	4015
20x...C456	250	456	3922	743	4665	20x...D415	350	415	3604	683	4287
2xG...C460	250	460	4779	1090	5869	2xG...D430	350	430	4385	971	5356
2xG...C540	315	540	5316	1216	6532	2xG...D485	400	485	5091	1126	6217
2xG...C567	315	567	5652	1298	6950	2xG...C545	450	545	5649	1253	6902
2xG...C650	355	650	7011	1577	8588	2xG...C617	500	617	6942	1489	8431
2xG...C750	400	750	7577	1726	9303	2xG...C710	600	710	7631	1659	9290
2xG...C770	400	770	8086	1848	9934	2xG...C740	650	740	8133	1776	9909

(1) Select watts loss based on catalog number.

(2) Frame 8 enclosure code B, L, and P.

Additional Watts Loss for Cabinet Options Bay

400V					480V				
Drive Catalog Number ⁽¹⁾	Normal Duty		Cabinet Options Bay		Drive Catalog Number ⁽¹⁾	Normal Duty		Cabinet Options Bay	
	kW	Cont. Output Amps	without Input or Output Line Reactor Watts ⁽²⁾	with Input or Output Line Reactor Watts ⁽²⁾		Hp	Cont. Output Amps	without Input or Output Line Reactor Watts ⁽²⁾	with Input or Output Line Reactor Watts ⁽²⁾
21G...C460	250	460	219	626	21G...D430	350	430	177	652
21G...C540	315	540	256	735	21G...D485	400	485	204	652
21G...C567	315	567	280	792	21G...D545	450	545	239	725
21G...C650	355	650	359	1123	21G...D617	500	617	295	983
21G...C750	400	750	404	1549	21G...D710	600	710	355	1410
21G...C770	400	770	441	1692	21G...D740	650	740	388	1542

(1) Select watts loss based on catalog number.

(2) For MCC Power Bus Options, add the following watts:

1250A Power Bus = 188 Watts, 2000A Power Bus = 261 Watts, 3200A Power Bus = 421 Watts

Derating Guidelines

Ambient Temperature/Load and Altitude/Load - 400V AC

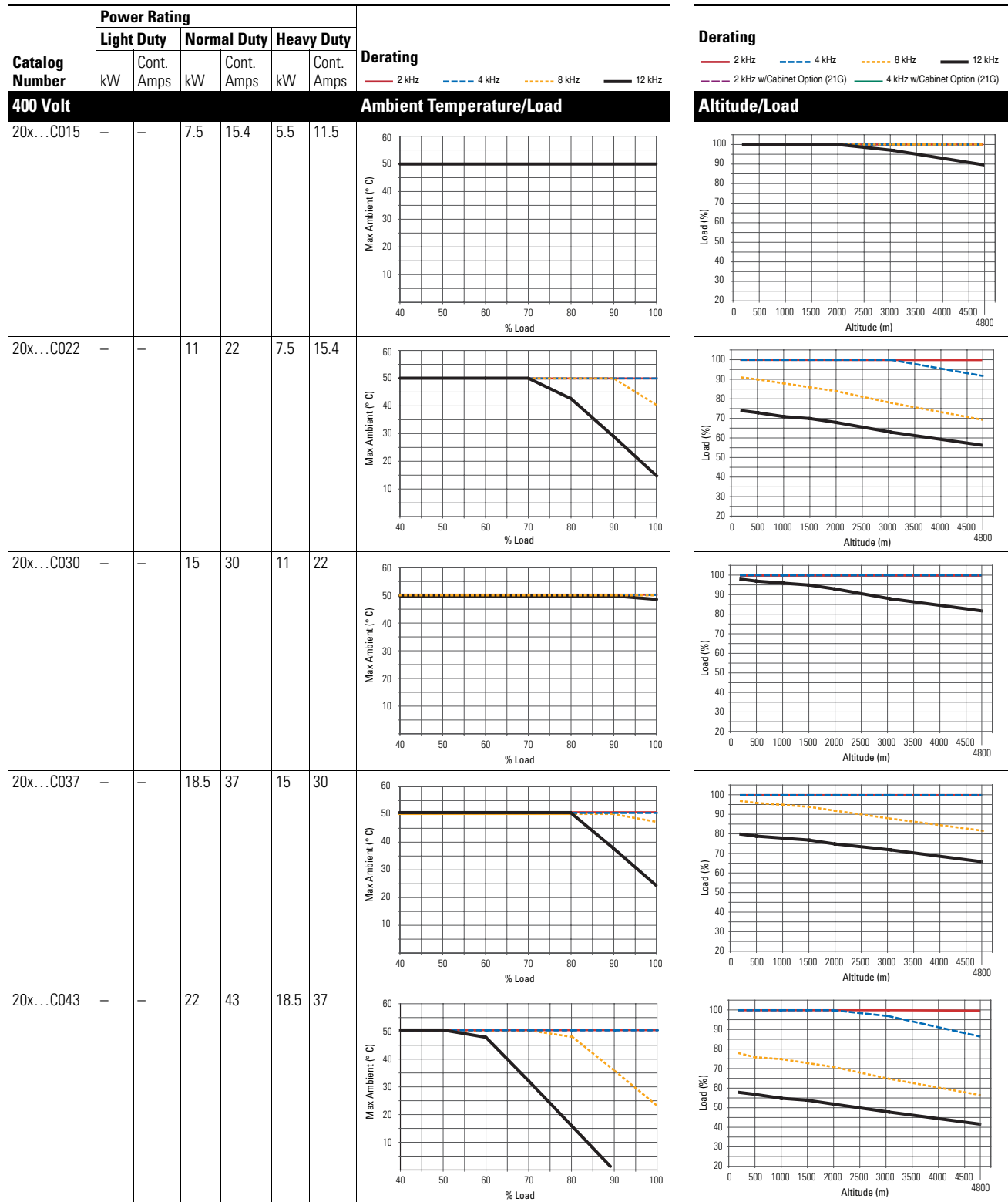

Catalog Number	Power Rating						Derating	Ambient Temperature/Load	Derating	Altitude/Load
	Light Duty		Normal Duty		Heavy Duty					
	kW	Cont. Amps	kW	Cont. Amps	kW	Cont. Amps				
400 Volt										
20x...C060	—	—	30	60	22	43				
20x...C072	—	—	37	72	30	60				
20x...C085	—	—	45	85	37	72				
20x...C104	—	—	55	104	45	85				
20x...C140	—	—	75	140	55	104				

Catalog Number	Power Rating						Derating — 2 kHz — 4 kHz - - - 8 kHz — 12 kHz
	Light Duty		Normal Duty		Heavy Duty		
	kW	Cont. Amps	kW	Cont. Amps	kW	Cont. Amps	
400 Volt							Ambient Temperature/Load
20x...C170	—	—	90	170	75	140	
20x...C205	—	—	110	205	90	170	
20x...C260	—	—	132	260	110	205	
20x...C302	—	—	160	302	132	260	
20x...C367	—	—	200	367	160	302	

Derating

— 2 kHz — 4 kHz - - - 8 kHz — 12 kHz
 - - - 2 kHz w/Cabinet Option (21G) — 4 kHz w/Cabinet Option (21G)

Altitude/Load

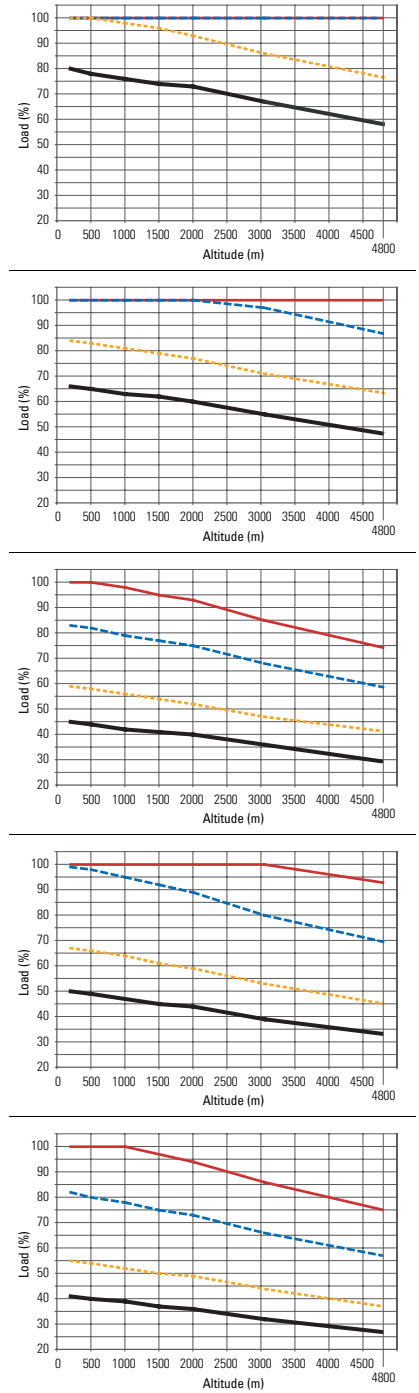

Catalog Number	Power Rating						Derating	Ambient Temperature/Load	Altitude/Load
	Light Duty		Normal Duty		Heavy Duty				
	kW	Cont. Amps	kW	Cont. Amps	kW	Cont. Amps			
400 Volt									
20x...C456	—	—	250	456	200	367			
2xG...C460	315	540	250	460	200	385			
2xG...C540	315	585	315	540	250	456			
2xG...C567	355	612	315	567	250	472			
2xG...C650	400	750	355	650	315	540			

Catalog Number	Power Rating						Derating 2 kHz 4 kHz 8 kHz 12 kHz
	Light Duty		Normal Duty		Heavy Duty		
	kW	Cont. Amps	kW	Cont. Amps	kW	Cont. Amps	
400 Volt							Ambient Temperature/Load
2xG...C750	450	796	400	750	315	585	
2xG...C770	450	832	400	770	355	642	

Derating	
Altitude/Load	

Ambient Temperature/Load and Altitude/Load - 480V AC

Catalog Number	Power Rating						Derating 2 kHz 4 kHz 8 kHz 12 kHz
	Light Duty		Normal Duty		Heavy Duty		
	Hp	Cont. Amps	Hp	Cont. Amps	Hp	Cont. Amps	
480 Volt							Ambient Temperature/Load
20x...D014	—	—	10	14	7.5	11	
20x...D022	—	—	15	22	10	14	

Derating	
Altitude/Load	

Catalog Number	Power Rating						Derating	
	Light Duty		Normal Duty		Heavy Duty			
	Hp	Cont. Amps	Hp	Cont. Amps	Hp	Cont. Amps		
480 Volt								
20x...D027	-	-	20	27	15	22		
20x...D034	-	-	25	34	20	27		
20x...D040	-	-	30	40	25	34		
20x...D052	-	-	40	52	30	40		
20x...D065	-	-	50	65	40	52		

Catalog Number	Power Rating						Derating 2 kHz (solid red) 4 kHz (dashed blue) 8 kHz (dotted orange) 12 kHz (solid black)
	Light Duty		Normal Duty		Heavy Duty		
	Hp	Cont. Amps	Hp	Cont. Amps	Hp	Cont. Amps	
480 Volt							Ambient Temperature/Load
20x...D077	—	—	60	77	50	65	
20x...D096	—	—	75	96	60	77	
20x...D125	—	—	100	125	75	96	
20x...D156	—	—	125	156	100	125	
20x...D186	—	—	150	186	125	156	

Derating

— 2 kHz - - - 4 kHz ····· 8 kHz — 12 kHz
 - - - 2 kHz w/Cabinet Option (21G) - - - 4 kHz w/Cabinet Option (21G)

Altitude/Load

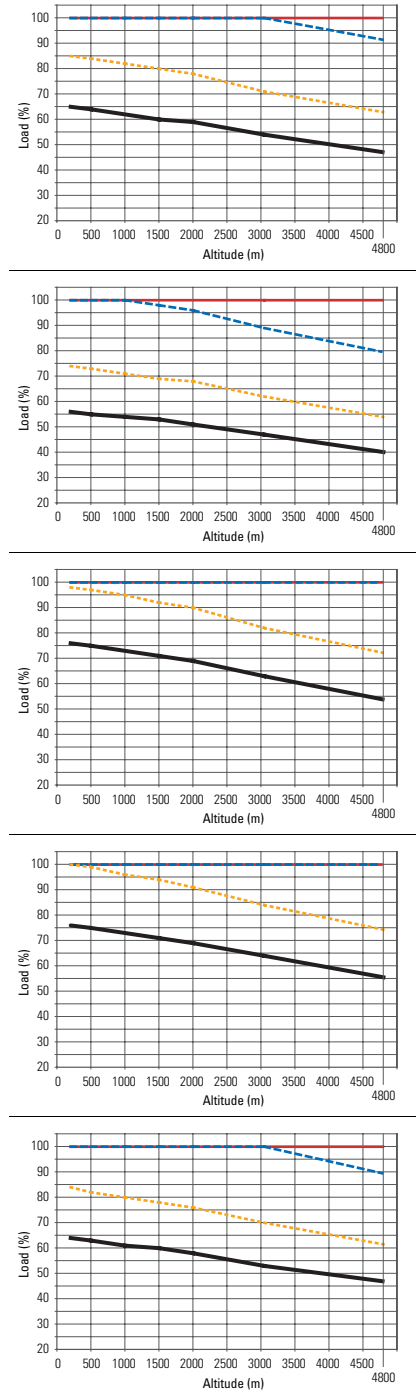

Catalog Number	Power Rating						Derating	Ambient Temperature/Load	Altitude/Load
	Light Duty		Normal Duty		Heavy Duty				
	Hp	Cont. Amps	Hp	Cont. Amps	Hp	Cont. Amps			
480 Volt									
20x...D248	-	-	200	248	150	186			
20x...D302	-	-	250	302	200	248			
20x...D361	-	-	300	361	250	302			
20x...D415	-	-	350	415	300	361			
2xG...D430	400	485	350	430	300	370			

Catalog Number	Power Rating						Derating 2 kHz 4 kHz 8 kHz 12 kHz
	Light Duty		Normal Duty		Heavy Duty		
	Hp	Cont. Amps	Hp	Cont. Amps	Hp	Cont. Amps	
480 Volt							Ambient Temperature/Load
2xG...D485	450	545	400	485	350	414	
2xG...D545	500	590	450	545	350	454	
2xG...D617	600	710	500	617	400	485	
2xG...D710	650	765	600	710	450	545	
2xG...D740	700	800	650	740	500	617	

Derating	
Altitude/Load	

Minimum Dynamic Brake Resistance

Table shows the minimum dynamic brake resistance when using the internal dynamic braking transistor.

Frame	400V			480V		
	ND kW	Minimum Resistance	Maximum DB Current	ND Hp	Minimum Resistance	Maximum DB Current
2	0.75	31.6	25	1.0	31.6	25
	1.5	31.6	25	2.0	31.6	25
	2.2	31.6	25	3.0	31.6	25
	4.0	31.6	25	5.0	31.6	25
	5.5	31.6	25	7.5	31.6	25
	7.5	31.6	25	10	31.6	25
	11	22.6	34.9	15	22.6	34.9
3	15	31.6	25	20	31.6	25
	18.5	31.6	25	25	31.6	25
	22	16.6	47.6	30	16.6	47.6
4	30	15.8	50	40	15.8	50
	37	15.8	50	50	15.8	50
5	37 ⁽¹⁾	7.9	100	50 ⁽¹⁾	7.9	100
	45	7.9	100	60	7.9	100
	55	7.9	100	75	7.9	100
6	55 ⁽¹⁾	3.3	239.4	75 ⁽¹⁾	3.3	239.4
	75	3.3	239.4	100	3.3	239.4
	90	3.3	239.4	125	3.3	239.4
	110	3.3	239.4	150	3.3	239.4
	132	3.3	239.4	200	3.3	239.4
7	132 ⁽¹⁾	2.4	329	200 ⁽¹⁾	2.4	329
	160	2.4	329	250	2.4	329
	200	2.4	329	300	2.4	329
	250	1.65	478.8	350	1.65	478.8

⁽¹⁾ IP54, NEMA/UL Type 12.

Fuse and Circuit Breaker Ratings

The tables on pages 22...25 provide drive ratings (including continuous, 1 minute and 3 second) and recommended AC line input fuse and circuit breaker information. Sizes listed are the recommended sizes based on 40 degree C and the U.S. N.E.C. Other country, state or local codes may require different ratings. In addition, Frame 8 drives include AC line fuses (with blown fuse indicators) to provide drive short circuit protection.

Input Device Requirements

Frames	Enclosure Catalog Code	Enclosure Type	Installation Type	UL Certification Required	UL Certification Not Required
2...5	N	IP20 NEMA/UL Open Type	Installed in a non-ventilated cabinet. Heat sink is inside or outside of cabinet.	All devices listed on pages 22 and 24 are acceptable.	All devices listed on pages 22 through 25 are acceptable.
	F				
	N	IP20 NEMA/UL Open Type	Installed outside of cabinet using NEMA Type 1 kit or in a ventilated cabinet.	Devices listed on pages 22 and 24 are acceptable, excluding time delay fuses and maximum value for non-time delay fuses.	
	F				
	G	IP54 NEMA/UL Type 12	Installed inside or outside of any cabinet.	All devices listed on pages 22 and 24 are acceptable.	
6...7	N	IP00 NEMA/UL Open Type	Installed in any cabinet. Heat sink is inside or outside of cabinet.		
			Installed outside of cabinet using NEMA Type 1 kit.		
	G	IP54 NEMA/UL Type 12	Installed inside or outside of any cabinet.		
8	B, L	IP20 NEMA/UL Type 1	Installed inside of any cabinet.	All devices listed on pages 23 and 25 are acceptable.	

Fusing

If fuses are chosen as the desired protection method, refer to the recommended types listed below. If available amp ratings do not match the tables provided, the closest fuse rating that exceeds the drive rating should be chosen.

- IEC – BS88 (British Standard) Parts 1 & 2⁽¹⁾, EN60269-1, Parts 1 & 2, type gG or equivalent should be used.
- UL – UL Class T, J or L should be used.

Circuit Breakers

The “non-fuse” listings in the following tables include both circuit breakers (inverse time or instantaneous trip). **If one of these is chosen as the desired protection method**, the following requirements apply.

- IEC and UL – Both types of devices are acceptable for IEC and UL installations.

(1) Typical designations include, but may not be limited to the following; Parts 1 & 2: AC, AD, BC, BD, CD, DD, ED, EFS, EF, FF, FG, GF, GG, GH.

400 Volt AC Input Protection Devices - Frames 2...7

Applied Rating (1) kW	Cont. Output Amps	Drive Sized For Normal Duty			Drive Sized For Heavy Duty			Input Quantities			AC Input Protection Devices					Input Quantities		DC Input Protection
		Catalog Number (x = F or G)	Output Amps 1 min. 3 sec.	Output Overload Amps 3 sec.	Catalog Number (x = F or G)	Output Amps 1 min. 3 sec.	Output Overload Amps 3 sec.	Dual Element Fuse Min(3) Max(4)	Non-Time Delay Fuse Min(3) Max(4)	Circuit Breaker Max Size (5)	Motor Circuit Protector (6)	1400M Motor Starter with Adjustable Current Range (7) (8)	Continuous AC Input kVA	Continuous AC Input Amps	Non-Time Delay Fuse	Amps	Non-Time Delay Fuse	
0.75 kW	2	20x...C2P1	3.1	3.7	20x...C2P1	3.1	3.7	3	6	3	8	1.2	1.7	3	8	1.1	2.1	JKS-6
1.5 kW	2	20x...C3P5	5.2	6.3	20x...C3P5	5.2	6.3	6	7	6	12	1.9	2.8	6	12	2.0	3.7	JKS-8
2.2 kW	2	20x...C5P0	7.5	9.0	20x...C5P0	7.5	9.0	6	10	6	20	3.1	4.5	6	20	2.9	5.3	JKS-10
4.0 kW	2	20x...C8P7	13.0	15.6	20x...C8P7	13.0	15.6	10	17.5	10	30	5.4	7.8	10	30	5.0	9.3	HSJ15
5.5 kW	2	20x...C011	17.2	20.7	20x...C011	17.2	20.7	15	25	15	45	7.4	10.7	15	45	6.8	12.6	HSJ20
7.5 kW	2	20x...C015	16.9	23.1	20x...C022	24.2	33.0	20	30	20	60	10.1	14.6	20	60	9.2	17.0	HSJ25
11 kW	2	20x...C022	24.2	33.0	20x...C030	33.0	45.0	30	45	30	80	14.6	21.1	30	80	13.3	24.6	HSJ40
15 kW	3	20x...C030	33.0	45.0	20x...C037	45.0	55.5	40	60	40	120	19.9	28.7	40	120	18.1	33.6	HSJ50
18.5 kW	3	20x...C043	47.3	64.5	20x...C043	47.3	64.5	45	80	45	125	24.5	35.4	45	125	22.3	41.4	HSJ70
22 kW	3	20x...C043	47.3	64.5	20x...C060	66.0	90.0	55	90	55	150	28.5	41.2	55	150	26.0	48.1	HSJ90
30 kW	4	20x...C060	66.0	90.0	20x...C072	90.0	108.0	75	125	75	225	39.8	57.4	75	225	36.2	67.1	HSJ100
37 kW	4	20x...C072	79.2	108.0	20x...C085	108.0	129.6	90	150	90	275	48.9	70.5	90	275	44.5	82.4	HSJ125
45 kW	5	20x...C085	93.5	127.5	20x...C104	127.5	156.0	110	175	110	325	57.7	83.3	110	325	52.5	97.3	HSJ150
55 kW	5	20x...C104	114.4	156.0	20x...C140	156.0	210.0	130	225	130	400	71.3	102.9	130	400	64.9	120.2	HSJ175
75 kW	6	20x...C140	154.0	210.0	20x...C170	210.0	255.0	175	300	175	550	95.0	137.2	175	550	86.5	160.3	HSJ250
90 kW	6	20x...C170	187.0	255.0	20x...C205	255.0	307.5	225	375	225	600	115.4	166.5	225	600	105.1	194.6	HSJ350
110 kW	6	20x...C205	225.5	307.5	20x...C260	307.5	390.0	275	450	275	600	139.1	200.8	275	600	126.7	234.7	HSJ350
132 kW	6	20x...C260	286.0	390.0	20x...C302	390.0	468.0	325	575	325	750	176.5	254.7	325	750	160.7	297.7	HSJ400
160 kW	7	20x...C302	332.2	453.0	20x...C367	453.0	550.5	400	675	400	900	205.0	295.9	400	900	186.7	345.7	Busman 170M6608
200 kW	7	20x...C367	403.7	550.5	20x...C456	550.5	684.0	475	800	475	1000	249.1	359.5	475	1000	226.9	420.2	Busman 170M6612
250 kW	7	20x...C456	501.6	684.0				600	1000	600	1300	309.5	446.7	600	1300	281.9	522.0	Busman 170M6613

Notes:

- "Applied Rating" refers to the motor that will be connected to the drive. For example, a "C022" drive can be used in Normal Duty mode on a 11 kW motor, or in Heavy Duty mode on a 7.5 kW motor. A "C015" drive can be used in Heavy Duty mode on a 5.5 kW motor with the same ratings as a "C011." The drive can be programmed for either mode. Wiring and fuses can be sized based on the programmed mode. For any given drive catalog number, Normal Duty mode provides higher continuous current but smaller overload current with respect to Heavy Duty mode. See parameter 306 [Duty Rating]. Enclosure codes F and N only. See page 30 for frame sizes of other enclosure types.
- Minimum protection device size is the lowest rated device that supplies maximum protection without nuisance tripping.
- Maximum protection device size is the highest rated device that supplies drive protection. For US NEC, minimum size is 125% of motor FLA. Ratings shown are maximum.
- Circuit Breaker - inverse time breaker. For US NEC, minimum size is 125% of motor FLA. Ratings shown are maximum.
- Recommended Motor circuit protector - Instantaneous trip circuit breaker. The trip setting should be set to the input current of the drive and should be sized for the continuous current of the system.
- Bulletin 140M with adjustable current range should have the current trip set to the minimum range that the device will not trip.
- Manual Self-Protected (Type E) Combination Motor Controller. 480Y/277V and 600Y/347V AC Input.

400 Volt AC Input Protection Devices - Frame 8

Applied Rating (1)	Continuous Output Amps	Duty	Catalog Number	Output Overload Amps		Continuous AC Input Amps	Integral Semiconductor Fuse Size (170M)(2)	AC Input Protection Devices Recommended for Branch Circuit Protection (Does not apply to 21G Drives with Cabinet Options)								
				1 min	3 sec			Dual Element Time Delay Fuse		Non-Time Delay Fuse		Circuit Breaker Max Size (5)	Motor Circuit Protector (6)			
								1/Phase Min(3)	2/Phase Min(3)	1/Phase Min(3)	2/Phase Min(3)			Max(4)	Max(4)	
400 Volt AC Input																
200 kW	8	385	Heavy	20G...C460	578	693	1100	500	—	850	500	—	1100	1100	500	
250 kW	8	460	Normal	20G...C460	506	693	1100	600	—	1000	600	—	1300	1300	600	
		456	Heavy	20G...C540	684	821	450	1100	600	—	1000	600	—	1300	1300	600
		472	Heavy	20G...C567	708	851	466	1100	600	—	1000	600	—	1400	1400	600
315 kW	8	540	Light	20G...C460	594	—	534	1100	700	350	1200	700	350	1600	1600	700
		540	Normal	20G...C540	594	821	533	1100	700	350	1200	700	350	1600	1600	700
		540	Heavy	20G...C650	810	975	533	1100	700	—	1200	700	—	1600	1600	700
315 kW	8	585	Light	20G...C540	644	—	578	1100	750	375	1300	750	375	1700	1700	800
		567	Normal	20G...C567	624	851	560	1100	750	375	1200	750	375	1700	1700	700
		585	Heavy	20G...C750	878	1125	577	1100	750	375	1300	750	375	1700	1700	800
355 kW	8	612	Light	20G...C567	673	—	604	1100	800	400	1300	800	400	1800	1800	800
		650	Normal	20G...C650	715	975	640	1100	850	425	1400	850	425	1900	1900	800
		642	Heavy	20G...C770	963	1155	634	1100	800	400	1400	800	400	1900	1900	800
400 kW	8	750	Light	20G...C650	825	—	739	1100	1000	500	1600	1000	500	2200	2200	1000
		750	Normal	20G...C750	825	1125	739	1100	1000	500	1600	1000	500	2200	2200	1000
		770	Normal	20G...C770	847	1155	758	1100	1000	500	1700	1000	500	2300	2300	1000
450 kW	8	796	Light	20G...C750	876	—	784	1100	1000	500	1700	1000	500	2300	2300	1000
		832	Light	20G...C770	915	—	819	1100	1100	550	1800	1100	550	2400	2400	1200

Notes:

- (1) "Applied Rating" refers to the motor that will be connected to the drive. For example, a "C460" drive can be used in Normal Duty mode on a 250 kW motor, in Heavy Duty mode on a 200 kW motor or in Light Duty mode on a 315 kW motor. The drive can be programmed for each mode. Wiring and fuses can be sized based on the programmed mode. For any given drive catalog number, Normal Duty mode provides higher continuous current but smaller overload current with respect to Heavy Duty mode. See parameter 306 [Duty Rating]. Refer to Specifications for an explanation of Duty Ratings.
- (2) These AC line fuses (with blown fuse indicators) are included in the drive to provide drive short circuit protection. AC input protection devices for branch circuit protection based on US NEC are listed in the table.
- (3) Minimum protection device size is the lowest rated device that supplies maximum protection without nuisance tripping.
- (4) Maximum protection device size is the highest rated device that supplies drive protection. For US NEC, minimum size is 125% of motor FLA. Ratings shown are maximum.
- (5) Circuit Breaker - inverse time breaker. For US NEC, minimum size is 125% of motor FLA. Ratings shown are maximum.
- (6) Recommended Motor circuit protector - Instantaneous trip circuit breaker. The trip setting should be set to the input current of the drive and should be sized for the continuous current of the system.

480 Volt AC Input Protection Devices - Frames 2...7

Applied Rating (1)	Cont. Output Amps	Drive Sized For Normal Duty		Drive Sized For Heavy Duty		Input Quantities				AC Input Protection Devices				Input Quantities		DC Input Protection				
		Catalog Number	Output Overload Amps	Catalog Number	Output Overload Amps	Continuous AC Input	Dual Element Time Delay	Non-Time Delay Fuse	Circuit Breaker Max Size (5)	Motor Circuit Protector (6)	140M Motor Starter with Adjustable Current Range (7) (8)	Continuous DC Input	Non-Time Delay Fuse							
1.0 Hp	2	20x...D2P1	3.1	3.7	20x...D2P1	3.1	3.7	1.3	1.6	2	6	2	8	15	3	M-CZE-B25	M-D8E-B25	1.2	1.9	JKS-6
2.0 Hp	2	20x...D3P4	5.1	6.1	20x...D3P4	5.1	6.1	2.2	2.6	4	7	4	12	15	7	M-CZE-B40	M-D8E-B40	1.9	3.0	JKS-6
3.0 Hp	2	20x...D5P0	7.5	9.0	20x...D5P0	7.5	9.0	3.2	3.9	6	10	6	20	20	7	M-CZE-B63	M-D8E-B63	2.9	4.5	JKS-10
5.0 Hp	2	20x...D8P0	12.0	14.4	20x...D8P0	12.0	14.4	5.7	6.9	10	17.5	10	30	30	15	M-CZE-C10	M-D8E-C10	5.2	8.1	HSJ15
7.5 Hp	2	20x...D011	16.5	19.8	20x...D011	16.5	19.8	7.9	9.5	12	20	12	40	40	15	M-CZE-C16	M-D8E-C16	7.2	11.1	HSJ20
10 Hp	2	20x...D014	15.4	21.0	20x...D022	24.2	33.0	10.4	12.5	20	30	20	55	50	20	M-CZE-C16	M-D8E-C16	9.5	14.7	HSJ30
15 Hp	2	20x...D022	24.2	33.0	20x...D027	33.0	40.5	16.6	19.9	30	50	30	80	80	30	M-CZE-C25	M-D8E-C25	15.1	23.3	HSJ40
20 Hp	3	20x...D027	29.7	40.5	20x...D034	40.5	51.0	20.6	24.8	35	60	35	100	100	50	M-F8E-C45	M-D8E-C45	18.8	28.9	HSJ50
25 Hp	3	20x...D034	37.4	51.0	20x...D040	51.0	61.2	25.9	31.2	45	75	45	125	100	50	M-F8E-C45	M-D8E-C45	23.6	36.4	HSJ60
30 Hp	3	20x...D040	44.0	60.0	20x...D052	60.0	78.0	30.5	36.7	50	90	50	150	120	50	M-F8E-C45	M-D8E-C45	27.8	42.9	HSJ80
40 Hp	4	20x...D052	57.2	78.0	20x...D065	78.0	97.5	39.7	47.7	65	110	65	200	150	70	M-F8E-C45	M-D8E-C45	36.1	55.7	HSJ90
50 Hp	4	20x...D065	71.5	97.5	20x...D077	97.5	117.0	49.6	59.6	90	125	90	250	175	100	M-F8E-C45	M-D8E-C45	45.1	69.7	HSJ100
60 Hp	5	20x...D077	84.7	115.5	20x...D096	115.5	144.0	60.1	72.3	100	170	100	300	225	100	M-F8E-C45	M-D8E-C45	54.7	84.5	HSJ150
75 Hp	5	20x...D096	105.6	144.0	20x...D125	144.0	187.5	74.9	90.1	125	200	125	375	275	125	M-F8E-C45	M-D8E-C45	68.3	105.3	HSJ175
100 Hp	6	20x...D125	137.5	187.5	20x...D156	187.5	234.0	97.6	117.4	175	275	175	500	375	250	M-F8E-C45	M-D8E-C45	88.9	137.1	HSJ200
125 Hp	6	20x...D156	171.6	234.0	20x...D186	234.0	280.8	121.8	146.5	200	350	200	600	450	250	M-F8E-C45	M-D8E-C45	110.9	171.2	HSJ300
150 Hp	6	20x...D186	204.6	279.0	20x...D248	279.0	372.0	145.2	174.6	250	400	250	800	550	250	M-F8E-C45	M-D8E-C45	132.2	204.1	HSJ400
200 Hp	6	20x...D248	272.8	372.0	20x...D302	372.0	453.0	193.6	232.8	325	550	325	700	700	400	M-F8E-C45	M-D8E-C45	176.3	272.1	HSJ400
250 Hp	7	20x...D302	332.2	453.0	20x...D361	453.0	543.6	235.7	283.5	400	675	400	900	900	600	M-F8E-C45	M-D8E-C45	214.7	331.3	Bussman 170M6608
300 Hp	7	20x...D361	397.1	541.5	20x...D415	541.5	649.8	281.8	338.9	475	800	475	1000	1000	600	M-F8E-C45	M-D8E-C45	256.6	396.1	Bussman 170M6612
350 Hp	7	20x...D415	456.5	622.5																

Notes:

- "Applied Rating" refers to the motor that will be connected to the drive. For example, a "D022" drive can be used in Normal Duty mode on a 10 Hp motor, or in Heavy Duty mode on a 15 Hp motor. A "D014" drive can be used in Heavy Duty mode on a 7.5 Hp motor with the same ratings as a "D011." The drive can be programmed for either mode. Wiring and fuses can be sized based on the programmed mode. For any given drive catalog number, Normal Duty mode provides higher continuous current but smaller overload current with respect to Heavy Duty mode. See parameter 306 [Duty Rating].
- Enclosure codes F and N only. See page 30 for frame sizes of other enclosure types.
- Minimum protection device size is the lowest rated device that supplies maximum protection without nuisance tripping.
- Maximum protection device size is the highest rated device that supplies drive protection. For US NEC, minimum size is 125% of motor FLA. Ratings shown are maximum.
- Circuit Breaker - inverse time breaker. For US NEC, minimum size is 125% of motor FLA. Ratings shown are maximum.
- Recommended Motor circuit protector - Instantaneous trip circuit breaker. The trip setting should be set to the input current of the drive and should be sized for the continuous current of the system.
- Bulletin 140M with adjustable current range should have the current trip set to the minimum range that the device will not trip.
- Manual Self-Protected (Type E) Combination Motor Controller. 480Y/277V and 600Y/347V AC Input.

480 Volt AC Input Protection Devices - Frame 8

Applied Rating (1) Frame	Continuous Output Amps	Duty	Catalog Number	Output Overload Amps		Continuous AC Input Amps	Integral Semiconductor Fuse Size (170M)(2)	AC Input Protection Devices Recommended for Branch Circuit Protection (Does not apply to 21G Drives with Cabinet Options)				Motor Circuit Protector(6)			
				1 min	3 sec			Dual Element Time Delay Fuse		Non-Time Delay Fuse			Circuit Breaker Max Size (5)		
				Amps				1/Phase Min(3)	2/Phase Min(3)	1/Phase Min(3)	2/Phase Min(3)			Max(4)	Max(4)
480 Volt AC Input															
300 Hp	8 370	Heavy	20G...D430	555	666	349	1100	450	—	800	450	—	1100	1100	450
350 Hp	8 430	Normal	20G...D430	473	666	406	1100	550	—	900	550	—	1200	1200	550
	414	Heavy	20G...D485	621	745	391	1100	500	—	900	500	—	1200	1200	500
	454	Heavy	20G...D545	681	818	428	1100	550	—	1000	550	—	1300	1300	550
400 Hp	8 485	Light	20G...D430	534	—	458	1100	600	—	1000	600	—	1400	1400	600
	485	Normal	20G...D485	534	745	458	1100	600	—	1000	600	—	1400	1400	600
450 Hp	8 485	Heavy	20G...D617	728	926	458	1100	600	—	1000	600	—	1400	1400	600
	545	Light	20G...D485	600	—	514	1100	650	—	1200	650	—	1600	1600	650
	545	Normal	20G...D545	600	818	514	1100	650	—	1200	650	—	1600	1600	650
500 Hp	8 545	Heavy	20G...D710	818	1065	514	1100	650	325	1200	650	325	1600	1600	650
	617	Light	20G...D545	649	—	557	1100	700	—	1300	700	—	1700	1700	700
	617	Normal	20G...D617	679	926	582	1100	750	325	1300	750	325	1800	1800	800
600 Hp	8 710	Heavy	20G...D740	926	1110	582	1100	750	375	1300	750	375	2400	1800	800
	710	Light	20G...D617	781	—	670	1100	850	425	1500	850	425	2100	2100	900
	710	Normal	20G...D710	781	1065	670	1100	850	425	1500	850	425	2100	2100	900
650 Hp	8 765	Light	20G...D710	842	—	722	1100	1000	500	1700	1000	500	2200	2200	1000
	740	Normal	20G...D740	814	1110	698	1100	900	450	1600	900	450	2200	2200	900
700 Hp	8 800	Light	20G...D740	880	—	755	1100	1000	500	1800	1000	500	1800	2400	1000

Notes:

- (1) "Applied Rating" refers to the motor that will be connected to the drive. For example, a "D430" drive can be used in Normal Duty mode on a 350 Hp motor, in Heavy Duty mode on a 300 Hp motor or in Light Duty mode on a 400 Hp motor. The drive can be programmed for each mode. Wiring and fuses can be sized based on the programmed mode. For any given drive catalog number, Normal Duty mode provides higher continuous current but smaller overload current with respect to Heavy Duty mode. See parameter 306 [Duty Rating]. Refer to Specifications for an explanation of Duty Ratings.
- (2) These AC line fuses (with blown fuse indicators) are included in the drive to provide drive short circuit protection. AC input protection devices for branch circuit protection based on US NEC are listed in the table.
- (3) Minimum protection device size is the lowest rated device that supplies maximum protection without nuisance tripping.
- (4) Maximum protection device size is the highest rated device that supplies drive protection. For US NEC, minimum size is 125% of motor FLA. Ratings shown are maximum.
- (5) Circuit Breaker - inverse time breaker. For US NEC, minimum size is 125% of motor FLA. Ratings shown are maximum.
- (6) Recommended Motor circuit protector - Instantaneous trip circuit breaker. The trip setting should be set to the input current of the drive and should be sized for the continuous current of the system.

Cable Considerations

Power Cable Types Acceptable for 200...600 Volt Installations

A variety of cable types are acceptable for drive installations. For an in depth discussion of cable types, including a table of maximum motor cable lengths, refer to the *Wiring and Grounding Guidelines for Pulse Width Modulated (PWM) AC Drives*, publication DRIVES-IN001.

Recommended Cable Design

Rating/Type	Description
600V 75 °C (167 °F)	<ul style="list-style-type: none"> • Four tinned copper conductors with XLPE insulation. • Copper braid/aluminum foil combination shield and tinned copper drain wire. • PVC jacket.

Wiring Considerations

Type		Wire Type(s)	Description	Min. Insulation Rating
Power (1) (2)	Standard	–	<ul style="list-style-type: none"> • Four tinned copper conductors with XLPE insulation. • Copper braid/aluminum foil combination shield and tinned copper drain wire. • PVC jacket. 	600V, 75 °C (167 °F)
	Signal (1) (3) (4)	Standard Analog I/O	–	0.750 mm ² (18 AWG), twisted pair, 100% shield w/drain.
	Remote Pot	–	0.750 mm ² (18 AWG), 3 conductor, shielded.	
	Encoder/ Pulse I/O <30 m (100 ft)	Combined	0.196 mm ² (24 AWG) individually shielded pairs.	
	Encoder/ Pulse I/O 30 to 152 m (100 to 500 ft)	Signal	0.196 mm ² (24 AWG) individually shielded pairs.	
		Power	0.750 mm ² (18 AWG) in.dividually shielded pairs	
		Combined	0.330 mm ² (18 AWG), power is 0.500 mm ² (20AWG) individually shielded pairs.	
	Encoder/ Pulse I/O 152 to 259 m (500 to 850 ft.)	Signal	0.196 mm ² (24 AWG) individually shielded pairs.	
		Power	0.750 mm ² (18 AWG) individually shielded pairs.	
		Combined	0.750 mm ² (18 AWG) individually shielded pairs.	
Digital I/O Safety Inputs Homing Inputs (1) (3) (4)	Un-shielded	–	Per US NEC or applicable national or local code.	300V, 60 °C (140 °F)
	Shielded	Multi-conductor shielded cable	0.750 mm ² (18 AWG), 3 conductor, shielded.	

(1) Control and signal wires should be separated from power wires by at least 0.3 meters (1 foot).

(2) The use of shielded wire for AC input power may not be necessary but is always recommended.

(3) If the wires are short and contained within a cabinet which has no sensitive circuits, the use of shielded wire may not be necessary, but is always recommended.

(4) I/O terminals labeled "(–)" or "Common" are not referenced to earth ground and are designed to greatly reduce common mode interference. Grounding these terminals can cause signal noise. For CE installations, 115V I/O must use shielded cable or have a cable length less than 30 m (98 ft).

Frame 8 Power Wiring Options

Cable Option	Wire Entry/Exit Location	IP20, NEMA/UL Type 1 Drive (2500 MCC Style Cabinet)		IP20, NEMA/UL Type 1 Drive and Cabinet Options (2500 MCC Style Cabinet)	
		600 mm (23.6 in.) Deep Drive Bay	800 mm (31.5 in.) Deep Drive Bay	600 or 800 mm Deep Drive Bay w/600 mm Wide Wiring Only Bay	600 or 800 mm Deep Drive Bay w/600 mm Cabinet Options Bay
Armored Cable with Conduit Hubs	Top Entry, Bottom Exit		✓	✓	✓
	Bottom Entry, Bottom Exit		✓	✓	
	Top Entry, Top Exit		✓	✓	
Shielded Cable with Conduit Hubs	Top Entry, Bottom Exit	✓	✓	✓	✓
	Bottom Entry, Bottom Exit		✓	✓	
	Top Entry, Top Exit		✓	✓	✓ ⁽²⁾
Shielded Cable without Conduit Hubs ⁽¹⁾	Bottom Entry, Bottom Exit	✓	✓	✓	

⁽¹⁾ Other configurations with shielded cable are possible, however the use of conduit hubs is recommended.

⁽²⁾ This wiring configuration is possible when there are no output options in the option bay and the motor connections are wired from the drive bay.

Motor Considerations

Due to the operational characteristics of AC variable frequency drives, motors with inverter grade insulation systems designed to meet or exceed NEMA MG1 Part 31.40.4.2 standards for resistance to spikes of 1600 volts are recommended.

Guidelines must be followed when using non-inverter grade motors to avoid premature motor failures. Refer to Wiring and Grounding Guidelines for Pulse Width Modulated (PWM) AC Drives, publication DRIVES-IN001 for recommendations.

Allen-Bradley Permanent Magnet Servo Motors

The following table contains a list of specifications for Allen-Bradley servo motors compatible with PowerFlex 750-Series drives. This list primarily includes 460V rated MP and 1326 Series Allen-Bradley servo motors. This information is provided to help configure PowerFlex 750-Series drive with the appropriate servo motor data. For information regarding compatibility and configuration of Allen-Bradley servo motors (including RDB Series Direct Drive Motors) and third party PM motors not listed here, contact Allen-Bradley Drives Technical Support.

Model Number	Motor NP Volts (line-line V rms)	Motor NP Amps (A rms)	Motor NP Hertz (Hz)	Motor NP RPM (oper. rpm)	Motor NP Power (kW)	Motor Poles	Current peak (A rms)	System Cont. Stall Torque (N•m)	Motor Max RPM
MPL-B4530K	460	7.8	200.7	3010	2.6	8	19.1	8.25	4000
MPL-B4560F	460	8.3	144.7	2170	3.2	8	25.5	14.1	3000
MPL-B520K	460	8.1	208	3120	3.5	8	23.3	10.7	4000
MPL-B540K	460	14.5	177.3	2660	5.4	8	42.4	19.4	4000
MPL-B560F	460	14.5	130.7	1960	5.5	8	42.4	26.8	3000
MPL-B580F	460	18.4	132.7	1990	7.1	8	66.5	34	3000
MPL-B580J	460	22.6	148	2220	7.9	8	66.5	34	3800
MPL-B640F	460	22.7	106	1590	6.11	8	46	36.7	3000
MPL-B660F	460	27.2	81.3	1220	6.15	8	67.9	48	3000
MPL-B680D	460	24	94	1410	9.3	8	66.5	62.8	2000
MPL-B680F	460	33.9	79.3	1190	7.5	8	67.9	60	3000
MPL-B860D	460	33.6	96	1440	12.5	8	67.5	83.1	2000
MPL-B880C	460	33.6	72.7	1090	12.6	8	69	110	1500
MPL-B880D	460	40.3	86.7	1300	15	8	113.2	110	2000
MPL-B960B	460	29.7	62	930	12.7	8	63.6	130	1200
MPL-B960C	460	38.9	76	1140	14.8	8	88.4	124.3	1500
MPL-B960D	460	50.2	76.7	1150	15	8	102.5	124.3	2000
MPL-B980B	460	31.8	59.3	890	15.02	8	70.7	162.7	1000
MPL-B980C	460	48.2	67.3	1010	16.8	8	99	158.2	1500
MPL-B980D	460	63.6	74.7	1120	18.6	8	141.4	158.2	2000
MPM-B1151F	480	1.5	266.7	4000	0.75	8	7	2.18	5000
MPM-B1151T	480	3.1	333.3	5000	0.9	8	14.5	2.18	7000
MPM-B1152C	480	2.3	166.7	2500	1.2	8	8.8	2.18	3000
MPM-B1152F	480	2.9	266.7	4000	1.4	8	15.5	4.74	5200
MPM-B1152T	480	5.2	266.7	4000	1.4	8	26.8	4.74	7000
MPM-B1153E	480	2.7	200	3000	1.4	8	15.3	6.55	3500
MPM-B1153F	480	3.2	266.7	4000	1.45	8	22.6	6.55	5500
MPM-B1153T	480	5.5	266.7	4000	1.45	8	39.2	6.55	7000
MPM-B1302F	480	3.4	266.7	4000	1.65	8	15.6	5.99	4500
MPM-B1302M	480	4.9	266.7	4000	1.65	8	22.6	5.99	6000
MPM-B1302T	480	6.6	266.7	4000	1.65	8	30.7	5.99	7000
MPM-B1304C	480	3.4	183.3	2750	2	8	15.8	10.2	2750
MPM-B1304E	480	4.1	166.7	2500	2.2	8	24.2	10.2	4000
MPM-B1304M	480	7.3	233.3	3500	2.2	8	42.9	10.2	6000
MPM-B1651C	480	4.7	200	3000	2.5	8	20.6	10.7	3500
MPM-B1651F	480	8.2	200	3000	2.5	8	36	10.7	5000
MPM-B1651M	480	10.9	200	3000	2.5	8	40.2	10.7	5000
MPM-B1652C	480	7	166.7	2500	3.8	8	23.8	16	2500
MPM-B1652E	480	8	233.3	3500	4.3	8	42.8	19.4	3500
MPM-B1652F	480	11	233.3	3500	4.3	8	59.5	19.4	4500
MPM-B1653C	480	10.5	133.3	2000	4.6	8	41.9	26.8	2500
MPM-B1653E	480	10.2	200	3000	5.1	8	51.6	26.8	3500
MPM-B1653F	480	13.2	200	3000	5.1	8	66.7	26.8	4000

Model Number	Motor NP Volts (line-line V rms)	Motor NP Amps (A rms)	Motor NP Hertz (Hz)	Motor NP RPM (oper. rpm)	Motor NP Power (kW)	Motor Poles	Current peak (A rms)	System Cont. Stall Torque (N•m)	Motor Max RPM
MPM-B2152C	480	12.3	133.3	2000	5.6	8	39.2	36.7	2500
MPM-B2152F	480	18.7	166.7	2500	5.9	8	69.3	33	4500
MPM-B2152M	480	21	166.7	2500	5.9	8	54	30	5000
MPM-B2153B	480	12.7	116.7	1750	6.8	8	42.4	48	2000
MPM-B2153E	480	19.3	133.3	2000	7.2	8	69.7	48	3000
MPM-B2153F	480	22.1	133.3	2000	7.2	8	69.6	45	3800
MPM-B2154B	480	13.9	116.7	1750	6.9	8	69.3	62.8	2000
MPM-B2154e	480	18.3	133.3	2000	7.5	8	69.5	56	3000
MPM-B2154F	480	19.8	133.3	2000	7.5	8	59.3	56	3300
1326AB-B515G ⁽¹⁾	460	9.5	88.7	2660	2.9	4	28.5	10.4	5000
1326AB-B520F ⁽¹⁾	460	8.8	70.3	2110	2.9	4	26.4	13.1	3500
1326AB-B530E ⁽¹⁾	460	9.5	74.3	2230	4.2	4	28.5	18	3000
1326AB-B720E ⁽¹⁾	460	17.5	70	2100	6.8	4	52.5	30.9	3500
1326AB-B720F ⁽¹⁾	460	27.5	117	3510	11.7	4	66.5	31.8	5000
1326AB-B730E ⁽¹⁾	460	22.8	78.3	2350	9.6	4	66.5	39	3350
1326AB-B740C ⁽¹⁾	460	20.9	52.3	1570	8.7	4	62.7	53	2200
1326AB-B740E ⁽¹⁾	460	32	79.7	2390	12.7	4	66.5	50.8	3400
MPG-B050-031 ⁽²⁾	460	16.3	92	920	1.2	12	32.5	12.4	2510
MPG-B110-031 ⁽²⁾	460	12.9	112	1120	2	12	31.1	17	2420
MPG-B110-091 ⁽²⁾	460	10.6	184	1840	1.6	12	20.5	8.3	3500
1326AS-B630F ⁽²⁾	460	7.8	142.7	2140	2.4	8	18.5	10.7	4500
1326AS-B660E ⁽²⁾	460	11.8	100.7	1510	3.4	8	29.8	21.5	3000
1326AS-B690E ⁽²⁾	460	19	87.3	1310	5	8	41.3	36.4	3000
1326AS-B840E ⁽²⁾	460	21.2	79.3	1190	4.7	8	39.5	37.6	3000
1326AS-B860C ⁽²⁾	460	17.6	77.3	1160	6	8	44.4	49.3	2000
MPG-B050-031 ⁽²⁾	460	16.3	92	920	1.2	12	32.5	12.4	2510
MPG-B110-031 ⁽²⁾	460	12.9	112	1120	2	12	31.1	17	2420
MPG-B110-091 ⁽²⁾	460	10.6	184	1840	1.6	12	20.5	8.3	3500

⁽¹⁾ 1326AB-series motors are being replaced by MPM-series motors. They will be available for a limited time. Do not specify for new projects.

⁽²⁾ 1326AS and MPG-series motors are no longer available. Do not specify for new projects.

For motor power and feedback cable information, refer to the Kinetix Motion Control Selection Guide (publication GMC-SG001).

Dimensions and Weights

Frame/Rating Cross-Reference

400V AC Input				480V AC Input				Frame Size							
Catalog Number	Light Duty kW Output	Normal Duty kW Output	Heavy Duty kW Output	Catalog Number	Light Duty Hp Output	Normal Duty Hp Output	Heavy Duty Hp Output	Enclosure Code							
								B	F	G	L	N	P		
20x...C2P1	—	0.75	0.75	20x...D2P1	—	1	1								
20x...C3P5	—	1.5	1.5	20x...D3P4	—	2	2								
20x...C5P0	—	2.2	2.2	20x...D5P0	—	3	3								
20x...C8P7	—	4	4	20x...D8P0	—	5	5		2	2				2	
20x...C011	—	5.5	5.5	20x...D011	—	7.5	7.5								
20x...C015	—	7.5	5.5	20x...D014	—	10	7.5								
20x...C022	—	11	7.5	20x...D022	—	15	10								
20x...C030	—	15	11	20x...D027	—	20	15								
20x...C037	—	18.5	15	20x...D034	—	25	20		3	3				3	
20x...C043	—	22	18.5	20x...D040	—	30	25								
20x...C060	—	30	22	20x...D052	—	40	30	—	4	4	—			4	—
20x...C072	—	37	30	20x...D065	—	50	40		5	5				5	
20x...C085	—	45	37	20x...D077	—	60	50								
20x...C104	—	55	45	20x...D096	—	75	60		6	6				6	
20x...C140	—	75	55	20x...D125	—	100	75								
20x...C170	—	90	75	20x...D156	—	125	100								
20x...C205	—	110	90	20x...D186	—	150	125								
20x...C260	—	132	110	20x...D248	—	200	150		N/A	N/A					
20x...C302	—	160	132	20x...D302	—	250	200								
20x...C367	—	200	160	20x...D361	—	300	250		7	7				7	
20x...C456	—	250	200	20x...D415	—	350	300								
2xG...C460	315	250	200	20x...D430	400	350	300								
2xG...C540	315	315	250	20x...D485	450	400	350								
2xG...C567	355	315	250	20x...D545	500	450	400								
2xG...C650	400	355	315	20x...D617	600	500	450	8				8		8	
2xG...C750	450	400	355	20x...D710	650	600	500								
2xG...C770	450	400	355	20x...D740	700	650	600								

Enclosure Options

Important: IP00, IP20, and NEMA/UL Open Type PowerFlex 750-Series drives must be mounted in a clean, dry location. Contaminants such as oils, corrosive vapors and abrasive debris must be kept out of the enclosure. These enclosures are intended for indoor use primarily to provide a degree of protection against contact with enclosed equipment. These enclosures offer no protection against airborne contaminants. Refer to the following tables for an explanation of enclosure options and the environmental specifications found on [page 6](#).

Pollution Degree Ratings According to EN 61800-5-1

Pollution Degree	Description
1	No pollution or only dry, non-conductive pollution occurs. The pollution has no influence.
2	Normally, only non-conductive pollution occurs. Occasionally, however, a temporary conductivity caused by condensation is to be expected, when the drive is out of operation.
3	Conductive pollution or dry non-conductive pollution occurs, which becomes conductive due to condensation, which is to be expected.
4	The pollution generates persistent conductivity caused, for example by conductive dust or rain or snow.

Drive Enclosure Ratings

Frames	Enclosure Type (Cat. No. Position 6)	Installed Accessory Kit	Front Side Rating		Back Side/Heat Sink Rating	
			Enclosure Type	Pollution Degree	Enclosure Type	Pollution Degree
2...5	N	None	IP20, NEMA/UL Open Type	1, 2	IP20, NEMA/UL Open Type	1, 2
		NEMA Type 1	IP20, NEMA/UL Type 1	1, 2	IP20, NEMA/UL Type 1	1, 2
		Flange	IP20, NEMA/UL Type 1	1, 2	IP20, NEMA/UL Type 1	1, 2
	F	None	IP20, NEMA/UL Open Type	1, 2	IP66, NEMA/UL Type 4X	1, 2, 3, 4
	G	None	IP54, NEMA/UL Type 12	1, 2, 3, 4	IP54, NEMA/UL Type 12	1, 2, 3, 4
6...7	N	None	IP00, NEMA/UL Open Type	1, 2	IP00, NEMA/UL Open Type Kit	1, 2
		NEMA Type 1	IP20, NEMA/UL Type 1	1, 2	IP20, NEMA/UL Type 1	1, 2
		NEMA Type 4X Flange	IP00, NEMA/UL Open Type	1, 2	IP66, NEMA/UL Type 4X	1, 2, 3, 4
	G	None	IP54, NEMA/UL Type 12	1, 2, 3, 4	IP54, NEMA/UL Type 12	1, 2, 3, 4
8	B, L, P	None	IP20, NEMA/UL Type 1, MCC	1, 2	IP20, NEMA/UL Type 1	1, 2

Minimum Mounting Clearances

Specified vertical clearance requirements (indicated below) are intended to be from drive to drive. Other objects can occupy this space; however, reduced airflow may cause protection circuits to fault the drive. The drive must be mounted in a vertical orientation as shown. In addition, inlet air temperature must not exceed the product specification.

Drive Enclosure Minimum Mounting Clearances

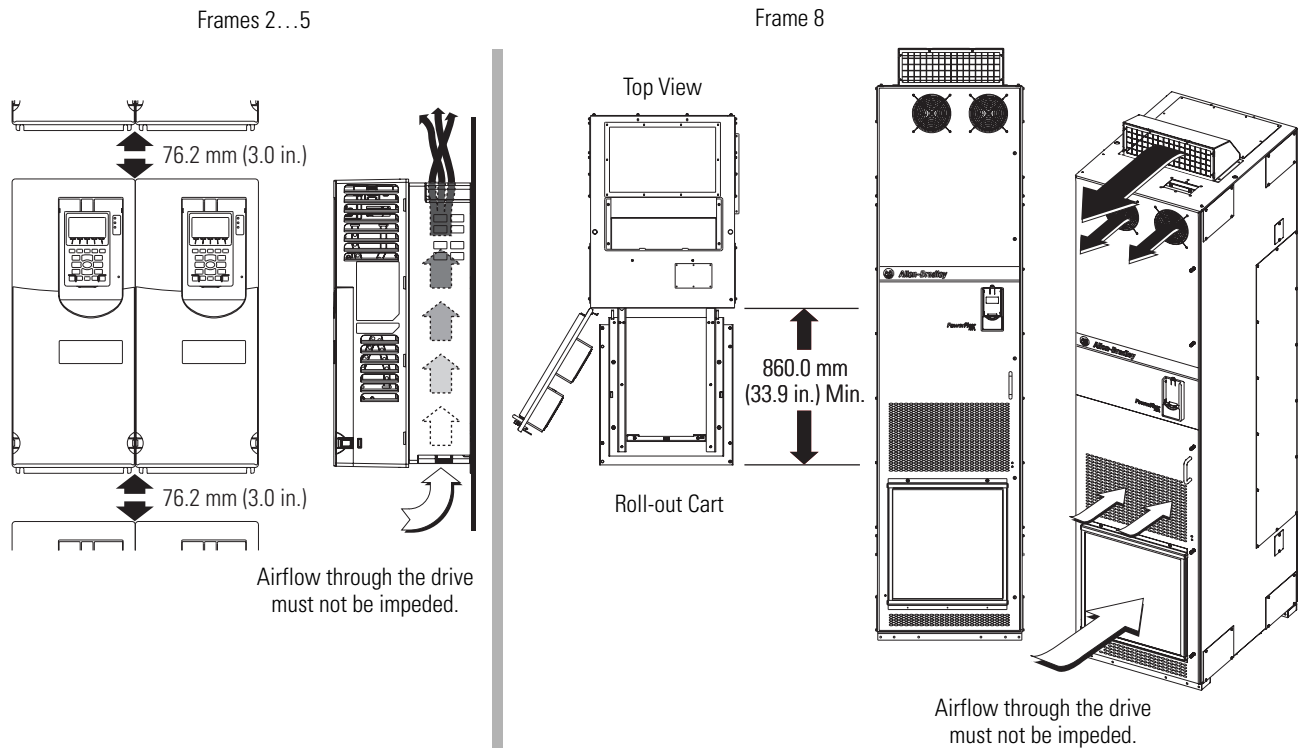

Approximate Weights

Approximate Drive Weights - Frames 2...7

Frame Size	Drive Rating		Weight <i>kg (lb)</i>		
	kW	Hp	Enclosure Code F	Enclosure Code G	Enclosure Code N
2	0.75...11	1...15	8 (17)	8 (17)	8 (17)
3	15...22	20...30	12 (26)	12 (26)	12 (26)
4	30...37	40...50	14 (30)	14 (30)	14 (30)
5	45...55	60...70	20 (45)	20 (45)	20 (45)
6	75	100	37 (81)	89 (197)	37 (82)
	90...132	125...200	38 (84)	91 (200)	39 (85)
7	160...200	250...300	69 (152)	135 (297)	79 (174)
	250	350	96 (212)	162 (357)	106 (234)

Maximum Drive Weights - Frame 8

Frame Size	Drive Rating		Weight <i>kg (lb)</i>		
	kW	Hp	Enclosure Code B	Enclosure Code L	Enclosure Code P
8	250...400	350...650	585 (1289)	585 (1289)	1145 (2525)

Maximum Component Weights - Frame 8

Component	Weight <i>kg (lb)</i>
Converter	73 (160)
Inverter	297 (615)
Drive (Open, IP00)	352 (775)

Approximate Dimensions

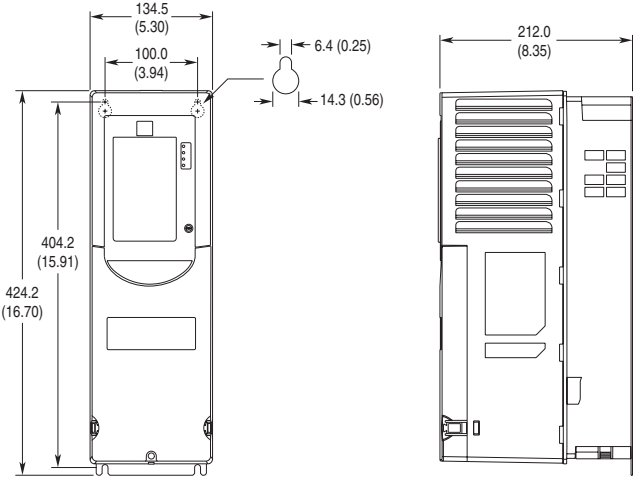
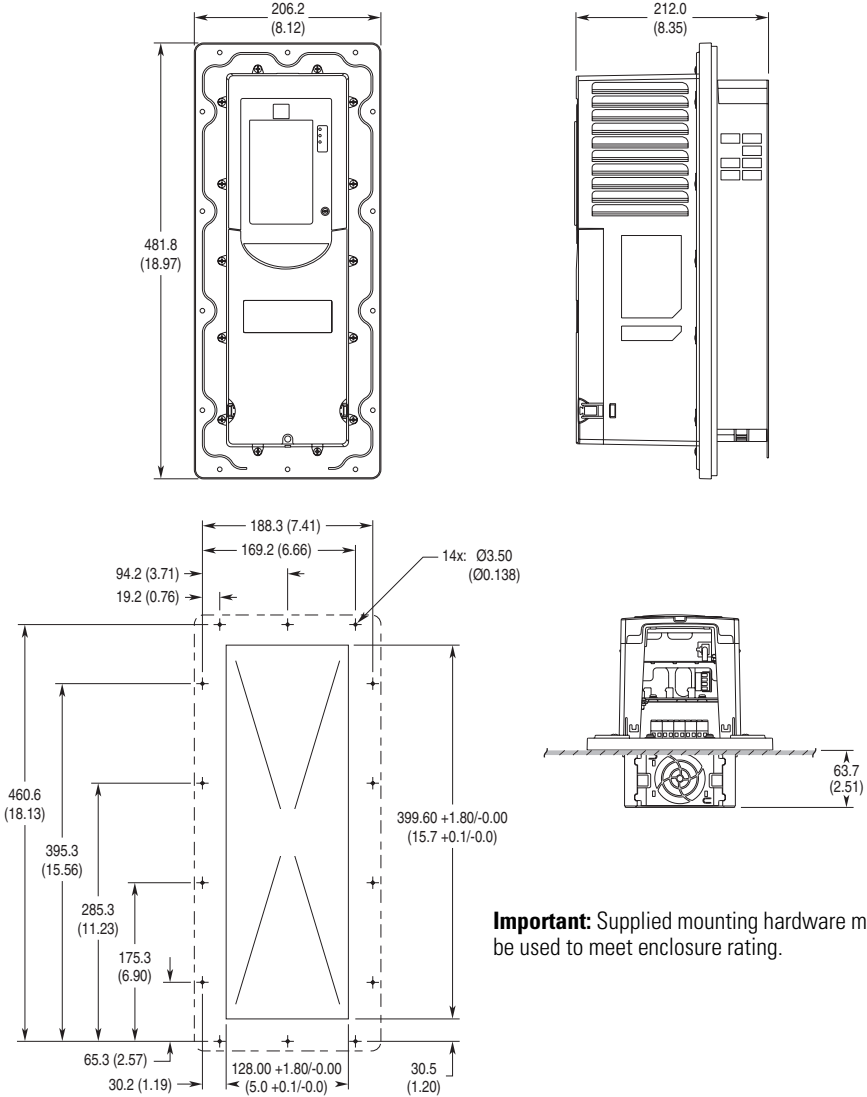
Frame	Type	Approximate Dimensions – mm (in.)
2	IP20, NEMA/UL Type Open	
2	Flange Mount	 <p>Important: Supplied mounting hardware must be used to meet enclosure rating.</p>

Frame	Type	Approximate Dimensions – mm (in.)
2	IP54, NEMA/UL Type 12	<p>Technical drawing of Frame 2 AC Drive showing front, side, and top views with dimensions:</p> <ul style="list-style-type: none"> Front View: Overall width 215.3 (8.48), mounting hole spacing 100.0 (3.94), overall height 543.2 (21.39), and internal height 528.2 (20.80). Side View: Overall depth 222.2 (8.75). Top View: Mounting hole spacing 88.1 (3.47), 85.7 (3.37), 65.1 (2.56), 44.5 (1.75), and 42.1 (1.66). It shows 2x Ø22.0 (Ø0.87) and 3x Ø29.0 (Ø1.14) holes. Mounting Hole Dimensions: 6.4 (0.25) and 14.3 (0.56).
3	IP20, NEMA/UL Open Type	<p>Technical drawing of Frame 3 AC Drive showing front, side, and top views with dimensions:</p> <ul style="list-style-type: none"> Front View: Overall width 190.0 (7.48), mounting hole spacing 158.0 (6.22), overall height 454.0 (17.87), and internal height 435.0 (17.13). Side View: Overall depth 212.0 (8.35). Mounting Hole Dimensions: 6.4 (0.25) and 14.3 (0.56).

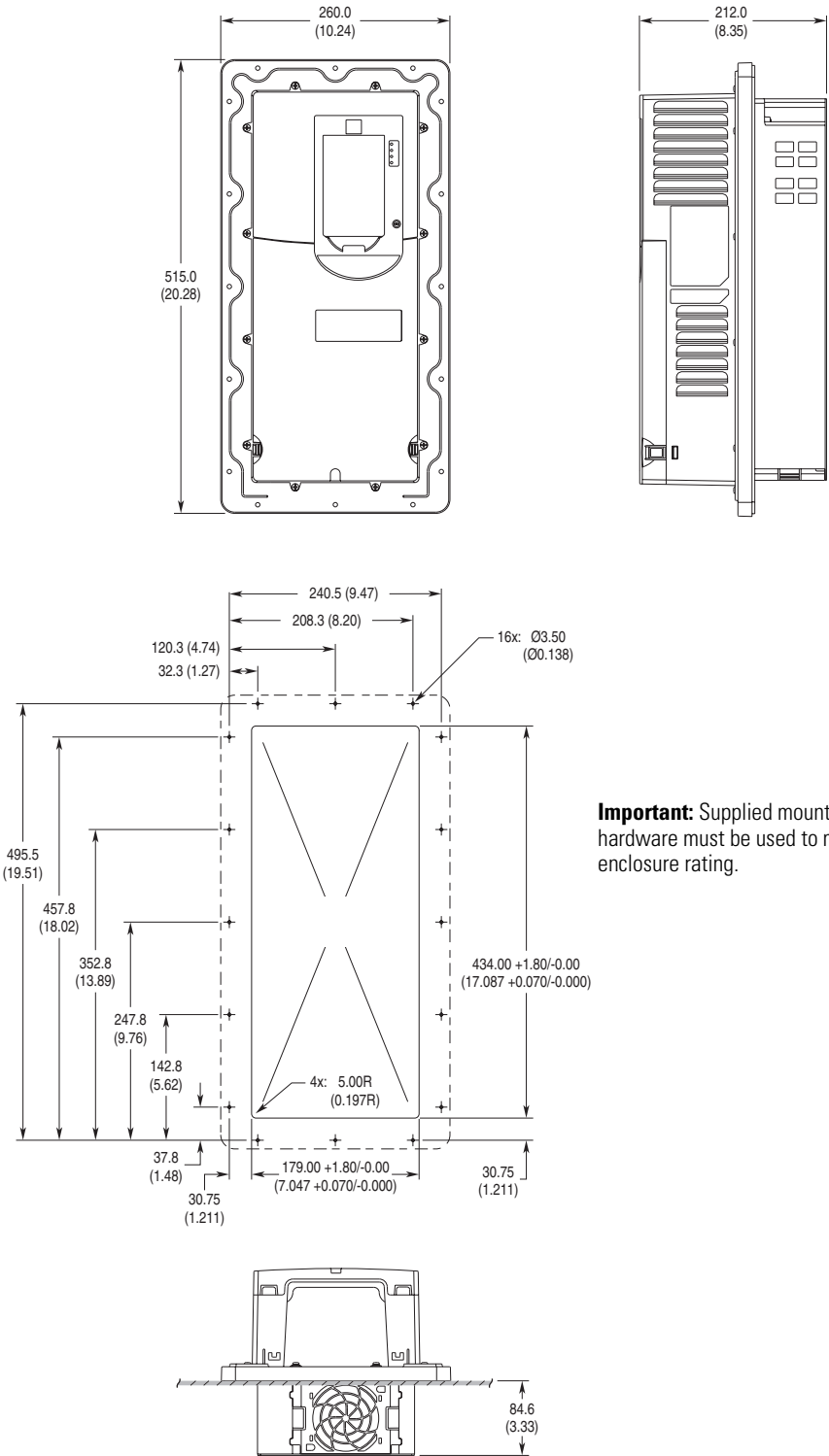
Frame	Type	Approximate Dimensions – mm (in.)
3	Flange Mount	 <p>Important: Supplied mounting hardware must be used to meet enclosure rating.</p>

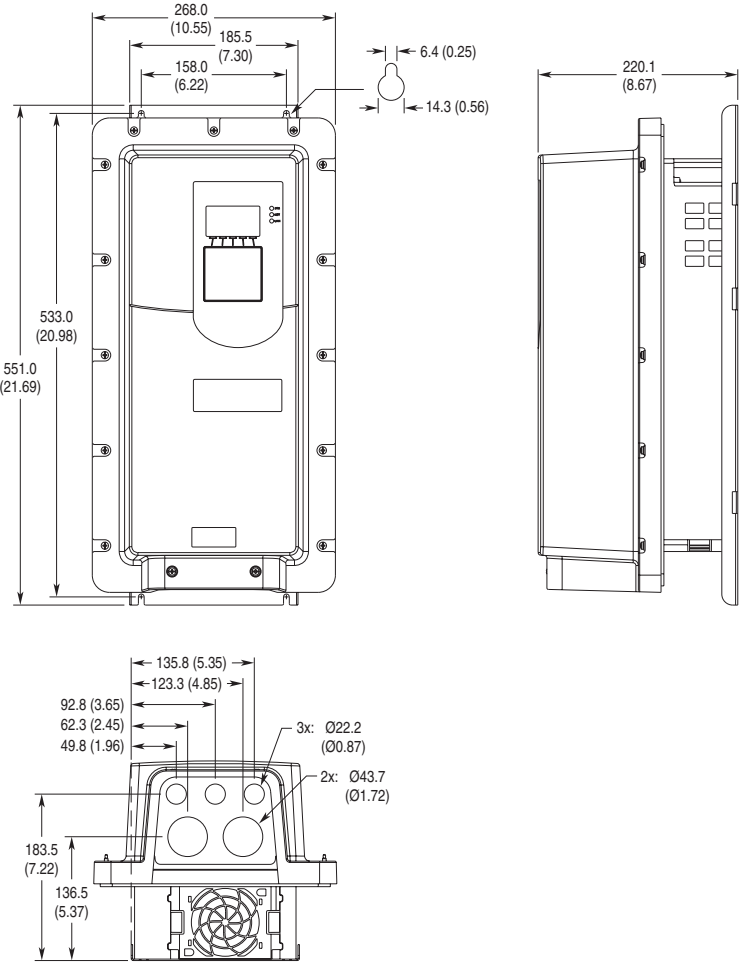
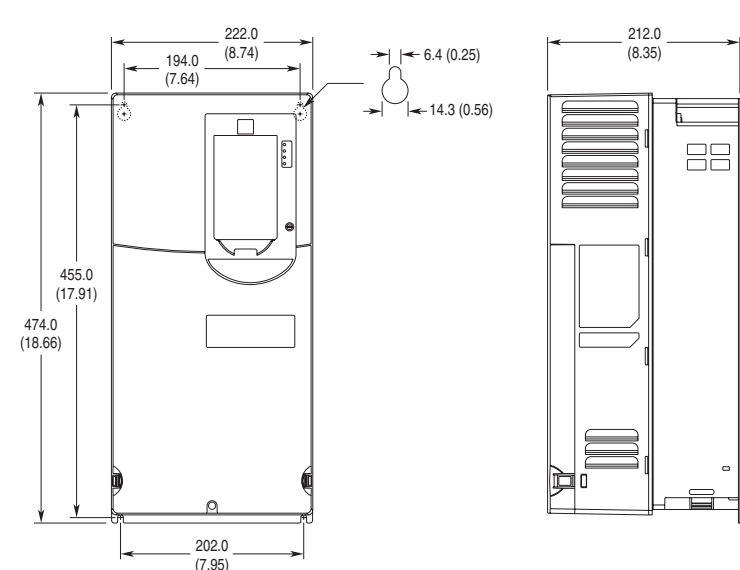
Frame	Type	Approximate Dimensions – mm (in.)
3	IP54, NEMA/UL Type 12	 <p>Technical drawing of Frame 3 AC Drive showing front, side, and top views with dimensions:</p> <ul style="list-style-type: none"> Front View: Overall width 268.0 (10.55), overall height 533.0 (20.98), mounting hole offset 51.0 (2.169), terminal block width 185.5 (7.30), terminal block offset 158.0 (6.22). Side View: Overall depth 220.1 (8.67). Top View: Overall width 135.8 (5.35), mounting hole offset 92.8 (3.65), terminal block offset 62.3 (2.45), terminal block width 49.8 (1.96), 3x Ø22.2 (Ø0.87) mounting holes, 2x Ø43.7 (Ø1.72) mounting holes, overall height 183.5 (7.22), fan height 136.5 (5.37). Mounting Hole Details: 6.4 (0.25) offset, 14.3 (0.56) diameter.
4	IP20, NEMA/UL Open Type	 <p>Technical drawing of Frame 4 AC Drive showing front, side, and top views with dimensions:</p> <ul style="list-style-type: none"> Front View: Overall width 222.0 (8.74), overall height 474.0 (18.66), mounting hole offset 45.0 (1.791), terminal block width 194.0 (7.64). Side View: Overall depth 212.0 (8.35). Mounting Hole Details: 6.4 (0.25) offset, 14.3 (0.56) diameter.

Frame	Type	Approximate Dimensions – mm (in.)
4	Flange Mount	<p>Important: Supplied mounting hardware must be used to meet enclosure rating.</p>

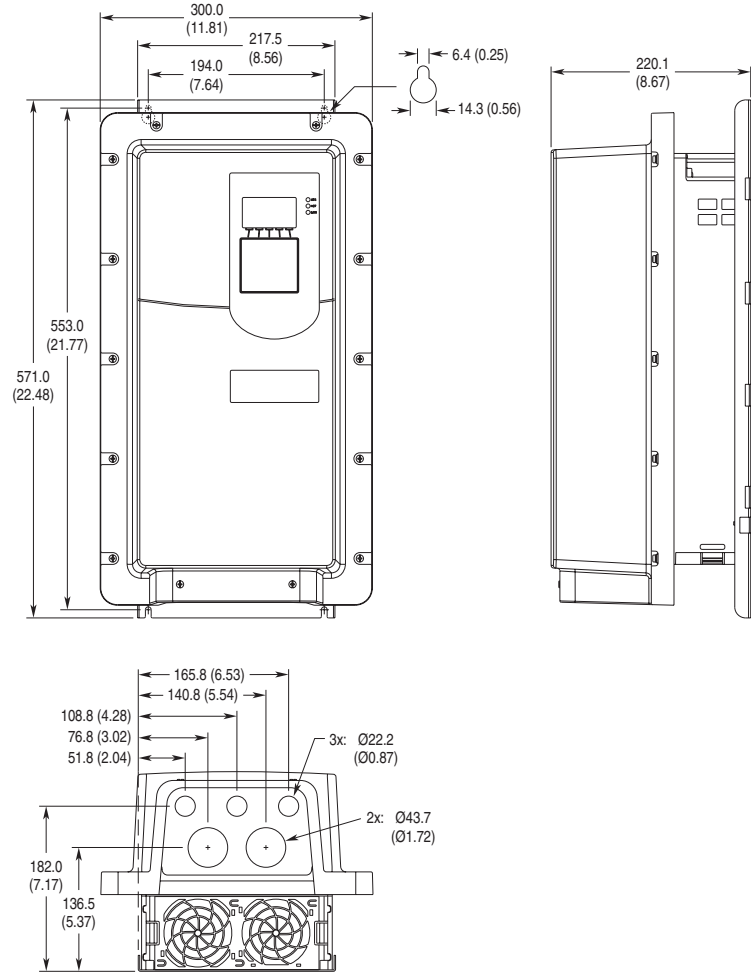
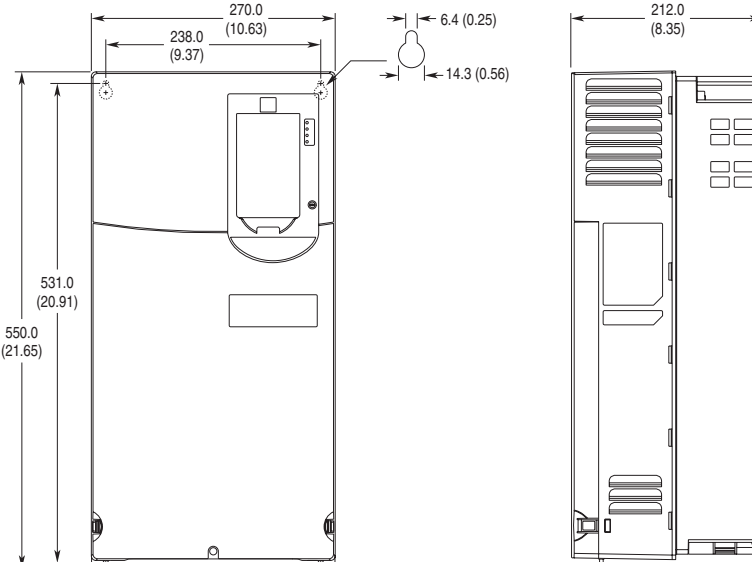
Frame	Type	Approximate Dimensions – mm (in.)
4	IP54, NEMA/UL Type 12	 <p>Technical drawing of Frame 4 AC Drive showing front, side, and top views with dimensions:</p> <ul style="list-style-type: none"> Front View: <ul style="list-style-type: none"> Overall width: 300.0 mm (11.81 in.) Terminal block width: 217.5 mm (8.56 in.) Terminal block offset: 194.0 mm (7.64 in.) Overall height: 571.0 mm (22.48 in.) Internal height: 553.0 mm (21.77 in.) Side View: <ul style="list-style-type: none"> Overall depth: 220.1 mm (8.67 in.) Top View: <ul style="list-style-type: none"> Terminal block width: 165.8 mm (6.53 in.) Terminal block offset: 140.8 mm (5.54 in.) Terminal block offset: 108.8 mm (4.28 in.) Terminal block offset: 76.8 mm (3.02 in.) Terminal block offset: 51.8 mm (2.04 in.) Terminal block offset: 182.0 mm (7.17 in.) Terminal block offset: 136.5 mm (5.37 in.) 3x: Ø22.2 (Ø0.87) 2x: Ø43.7 (Ø1.72)
5	IP20, NEMA/UL Open Type	 <p>Technical drawing of Frame 5 AC Drive showing front, side, and top views with dimensions:</p> <ul style="list-style-type: none"> Front View: <ul style="list-style-type: none"> Overall width: 270.0 mm (10.63 in.) Terminal block width: 238.0 mm (9.37 in.) Overall height: 550.0 mm (21.65 in.) Internal height: 531.0 mm (20.91 in.) Side View: <ul style="list-style-type: none"> Overall depth: 212.0 mm (8.35 in.)

Frame	Type	Approximate Dimensions – mm (in.)
5	Flange Mount	<p>Important: Supplied mounting hardware must be used to meet enclosure rating.</p>

Frame	Type	Approximate Dimensions – mm (in.)
5	IP54, NEMA/UL Type 12	<p>Technical drawing showing approximate dimensions for Frame 5, IP54, NEMA/UL Type 12. Dimensions are provided in mm (in.).</p> <p>Front View Dimensions:</p> <ul style="list-style-type: none"> Total Width: 348.0 mm (13.70 in.) Terminal Block Width: 265.5 mm (10.45 in.) Terminal Block Height: 238.0 mm (9.37 in.) Total Height: 647.0 mm (25.47 in.) Terminal Block Height (to top): 629.0 mm (24.76 in.) Bottom Flange Width: 6.4 mm (0.25 in.) <p>Side View Dimension:</p> <ul style="list-style-type: none"> Depth: 220.1 mm (8.67 in.) <p>Top View Dimensions:</p> <ul style="list-style-type: none"> Terminal Block Width: 212.8 mm (8.38 in.) Terminal Block Height: 172.8 mm (6.80 in.) Terminal Block Depth: 132.8 mm (5.23 in.) Terminal Block Height (to top): 92.8 mm (3.65 in.) Terminal Block Height (to bottom): 52.8 mm (2.08 in.) Terminal Block Width (to center): 181.9 mm (7.16 in.) Terminal Block Height (to center): 141.9 mm (5.59 in.) 3x: Ø22.2 (Ø0.87) 2x: Ø50.0 (Ø1.97)

Frame	Type	Approximate Dimensions – mm (in.)
6	IP00, NEMA/UL Open Type	<p>Important: Always install mounting hardware in all four corners of the mounting legs for stability. Only install mounting hardware through the top key holes to help insure the drive is securely fastened to the mounting surface. At the bottom of the mounting legs, either the key holes or optional open mounting slots may be used.</p>

Frame	Type	Approximate Dimensions – mm (in.)
6	IP54, NEMA/UL Type 12	<p>609.4 (23.99)</p> <p>558.8 (22.00)</p> <p>1298.3 (51.11)</p> <p>1238.3 (48.75)</p> <p>464.7 (18.30)</p> <p>1058.1 (41.66)</p> <p>10.5 (0.41)</p> <p>ø22.0 (0.87)</p> <p>Shown with the field installed 20-HIM-C6S</p>

Frame	Type	Approximate Dimensions – mm (in.)
7	IP00, NEMA/UL Open Type	<p>Important: Always install mounting hardware in all four corners of the mounting legs for stability.</p> <p>Only install mounting hardware through the top key holes to help insure the drive is securely fastened to the mounting surface.</p> <p>At the bottom of the mounting legs, either the key holes or optional open mounting slots may be used.</p>

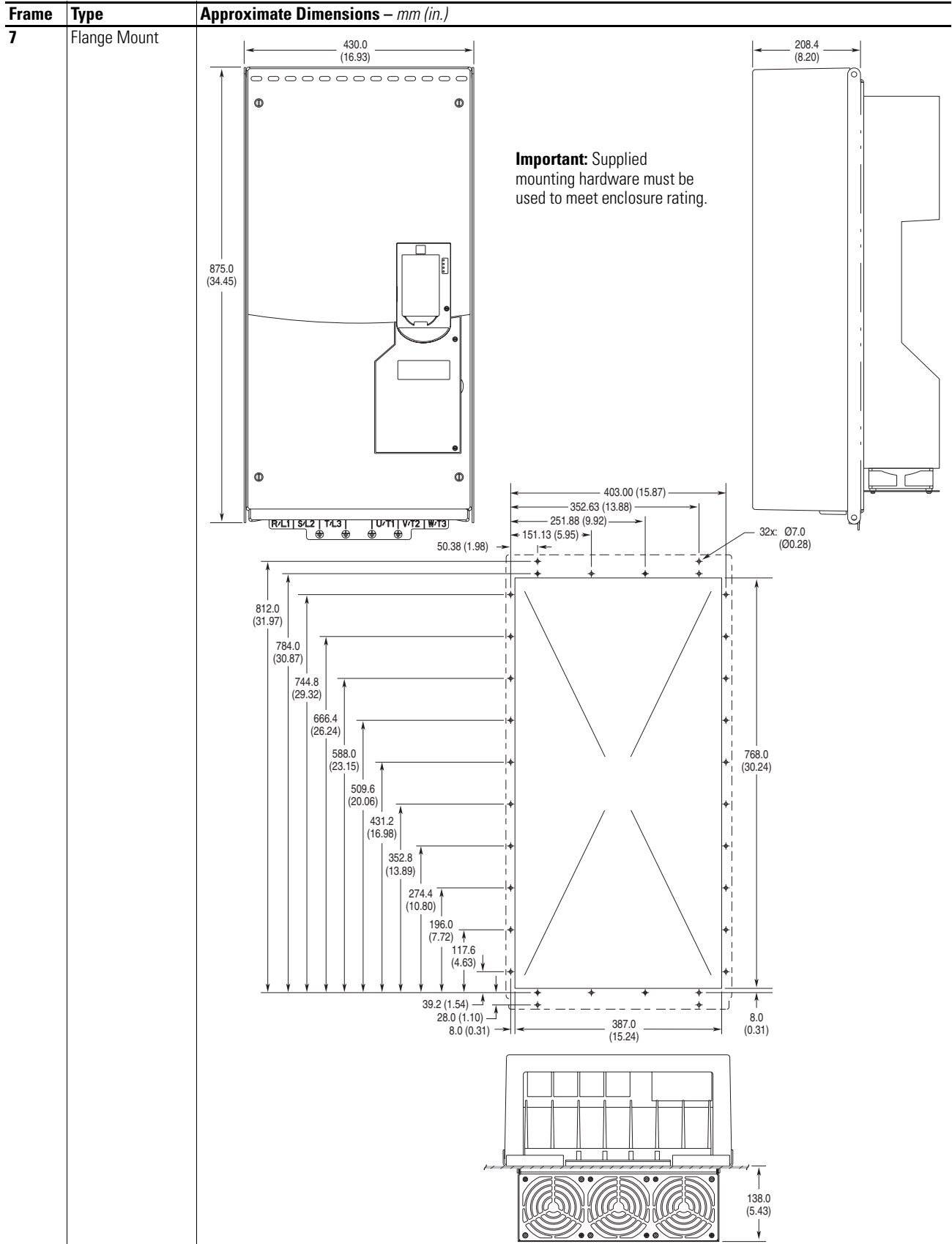

Frame	Type	Approximate Dimensions – mm (in.)
7	NEMA/UL Type 1	<p>The technical drawing illustrates the dimensions of the enclosure for Frame 7, NEMA/UL Type 1. It includes a front view on the left and a side view on the right. Key dimensions are as follows:</p> <ul style="list-style-type: none"> Front View Dimensions: <ul style="list-style-type: none"> Overall width: 430.0 mm (16.93 in.) Internal width: 380.0 mm (14.96 in.) Overall height: 1271.0 mm (50.04 in.) Height to top of drive unit: 1221.0 mm (48.07 in.) Height to top of terminal block: 881.8 mm (34.72 in.) Height to bottom of terminal block: 825.0 mm (32.48 in.) Height to bottom of enclosure: 339.2 mm (13.35 in.) Offset from left edge to terminal block: 20.5 mm (0.81 in.) Internal width to terminal block: 389.0 mm (15.31 in.) Overall width to terminal block: 430.0 mm (16.93 in.) Side View Dimensions: <ul style="list-style-type: none"> Overall width: 561.0 mm (22.08 in.) Height to top of enclosure: 389.2 mm (15.32 in.) Offset from left edge to terminal block: 8.5 mm (0.33 in.) Terminal block diameter: $\phi 16.0$ mm (0.63 in.)

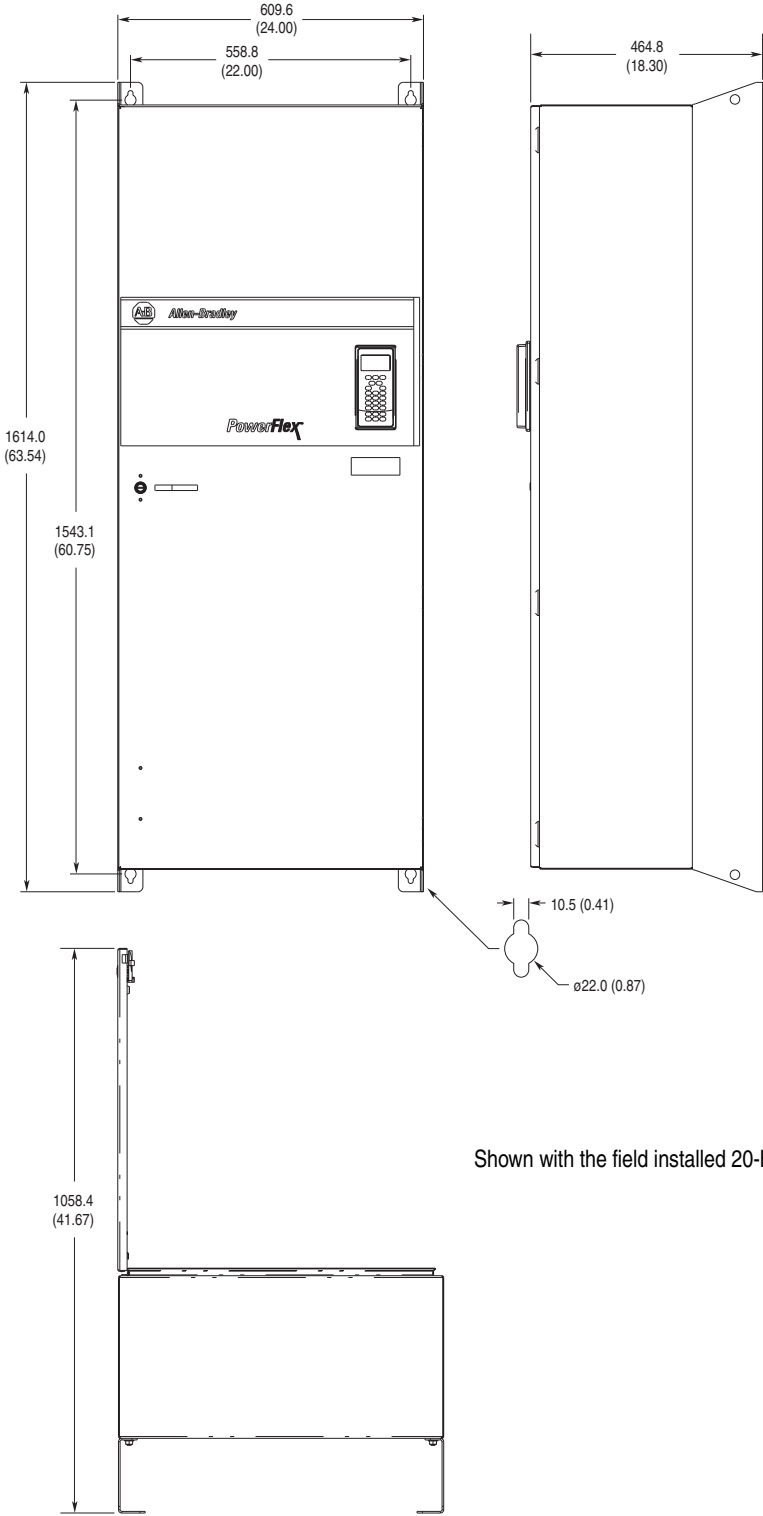
Frame	Type	Approximate Dimensions – mm (in.)
7	IP54, NEMA/UL Type 12	 <p>The drawing shows three views of the drive: a front view, a side view, and a bottom view. The front view shows a vertical cabinet with a control panel on the right side. Dimensions include a total width of 609.6 mm (24.00 in.), a mounting hole spacing of 558.8 mm (22.00 in.), a total height of 1614.0 mm (63.54 in.), and a height to the top of the control panel of 1543.1 mm (60.75 in.). The side view shows a depth of 464.8 mm (18.30 in.). The bottom view shows a width of 1058.4 mm (41.67 in.). A detail of a mounting hole is shown with a diameter of 22.0 mm (0.87 in.) and a hole offset of 10.5 mm (0.41 in.). The drive is shown with a 20-HIM-C6S field installed.</p> <p>Shown with the field installed 20-HIM-C6S</p>

Frame	Type	Approximate Dimensions – mm (in.)
8	IP20, NEMA/UL Type 1, MCC Style Cabinet, 600 mm (23.6 in.) Deep	<p>The technical drawings show the following dimensions:</p> <ul style="list-style-type: none"> Top View: Width 440 mm (17.3 in.), depth 127 mm (5.0 in.). Mounting hole offset is 68 mm (2.7 in.) from the top edge and 76 mm (3.0 in.) from the side edge. Front View: Total height 2453 mm (96.6 in.), mounting hole offset 2300 mm (90.6 in.). Cabinet depth 600 mm (23.6 in.). Features include a top grille, two fans, a PowerFlex logo, a drive unit, a large front door, and a bottom grille. Side View: Shows the 600 mm (23.6 in.) depth and a 240 mm (9.4 in.) wide top section. Bottom View: Total width 531 mm (20.9 in.), mounting hole offset 300 mm (11.8 in.) from the left edge. Cabinet depth 542 mm (21.3 in.). Mounting hole offset 43 mm (1.7 in.) from the bottom edge. A 76 mm (3.0 in.) offset is shown for the top edge. A hole diameter of $\phi 18.0$ (0.71 in.) is indicated. A 141 mm (5.6 in.) offset is shown for the drive unit, which is 500 mm (19.7 in.) wide.

Frame	Type	Approximate Dimensions – mm (in.)
8	IP20, NEMA/UL Type 1, MCC Style Cabinet, 800 mm (31.5 in.) Deep	<p>The technical drawing illustrates the dimensions of the PowerFlex 750-Series AC Drive cabinet (Frame 8) in three views: front, side, and top.</p> <ul style="list-style-type: none"> Front View: Shows a vertical cabinet with a total height of 2453 mm (96.6 in.). The main body height is 2300 mm (90.6 in.). The top section has a width of 600 mm (23.6 in.). The cabinet features two fans, a digital display, and a large ventilation grille. The Allen-Bradley logo and PowerFlex branding are visible. Side View: Shows the cabinet's depth of 800 mm (31.5 in.). The top section has a depth of 240 mm (9.4 in.). Top View: Shows the cabinet's footprint with a total width of 440 mm (17.3 in.) and a total height of 742 mm (29.2 in.). The main body width is 292 mm (11.5 in.). The top section has a width of 76 mm (3.0 in.) and a height of 127 mm (5.0 in.). The cabinet has a depth of 531 mm (20.9 in.) and a total width of 300 mm (11.8 in.). The top section has a height of 43 mm (1.7 in.) and a depth of 69 mm (2.7 in.). A hole with a diameter of 18.0 mm (0.71 in.) is located on the top edge.

Frame	Type	Approximate Dimensions – mm (in.)
8	IP20, NEMA/UL Type 1, MCC Style Cabinet with Cabinet Option Bay 600 mm (23.6 in.) Deep	<p>The technical drawing illustrates the dimensions of the cabinet for Frame 8. It includes three views: a top view, a front view, and a side view.</p> <ul style="list-style-type: none"> Top View: Shows two drive bays, each 440 mm (17.3 in.) wide. The total width is 1200 mm (47.2 in.). The depth is 600 mm (23.6 in.). Mounting holes are spaced 76 mm (3.0 in.) from the top and 127 mm (5.0 in.) from the side. Front View: Shows a total height of 2453 mm (96.6 in.). The main drive section is 2300 mm (90.6 in.) high. It features four fans at the top, a door with a handle, and ventilation grilles. The 'Allen-Bradley' and 'PowerFlex' logos are visible. Side View: Shows the cabinet's depth of 600 mm (23.6 in.) and a top section height of 240 mm (9.4 in.). Bottom View: Shows the base dimensions: 1131 mm (44.5 in.) total width, 900 mm (35.4 in.) to the center of the drive bays, and 542 mm (21.3 in.) to the right side. Mounting feet are 69 mm (2.7 in.) high. A hole diameter of 18.0 mm (0.71 in.) is indicated.

Frame	Type	Approximate Dimensions – mm (in.)
8	IP20, NEMA/UL Type 1, MCC Style Cabinet with Cabinet Option Bay 800 mm (31.5 in.) Deep	<p>The technical drawings show the following dimensions:</p> <ul style="list-style-type: none"> Top View: Two drive bays, each 440 mm (17.3 in.) wide and 270 mm (10.6 in.) high. The distance between the centers of the bays is 152 mm (6.0 in.). The total width of the cabinet is 1200 mm (47.2 in.). Front View: Total height is 2453 mm (96.6 in.). The main drive section is 2300 mm (90.6 in.) high. It features four fans at the top, a control panel with a digital display, and a door with a handle. The cabinet is 800 mm (31.5 in.) deep. Side View: Shows the 800 mm (31.5 in.) depth of the cabinet. Bottom View: Shows the base dimensions. The total width is 1131 mm (44.5 in.). The distance from the left edge to the center of the drive bays is 900 mm (35.4 in.). The distance from the center of the drive bays to the right edge is 669 mm (26.3 in.). The distance from the center of the drive bays to the right edge of the control panel is 531 mm (20.9 in.). The distance from the center of the drive bays to the right edge of the cabinet is 300 mm (11.8 in.). The distance from the center of the drive bays to the right edge of the cabinet is 69 mm (2.7 in.). The distance from the center of the drive bays to the right edge of the cabinet is 43 mm (1.7 in.). The distance from the center of the drive bays to the right edge of the cabinet is 76 mm (3.0 in.). The distance from the center of the drive bays to the right edge of the cabinet is 127 mm (5.0 in.). The distance from the center of the drive bays to the right edge of the cabinet is 200 mm (7.9 in.). The distance from the center of the drive bays to the right edge of the cabinet is 440 mm (17.3 in.). The distance from the center of the drive bays to the right edge of the cabinet is 292 mm (11.5 in.). The distance from the center of the drive bays to the right edge of the cabinet is 742 mm (29.2 in.). The distance from the center of the drive bays to the right edge of the cabinet is 18.0 mm (0.71 in.).

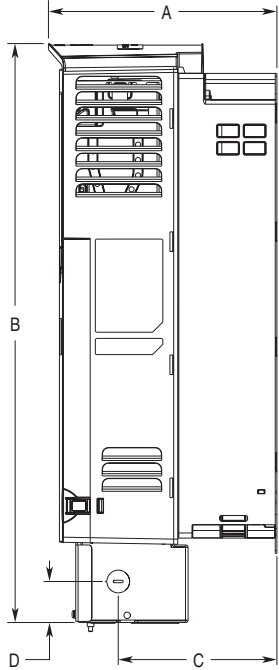
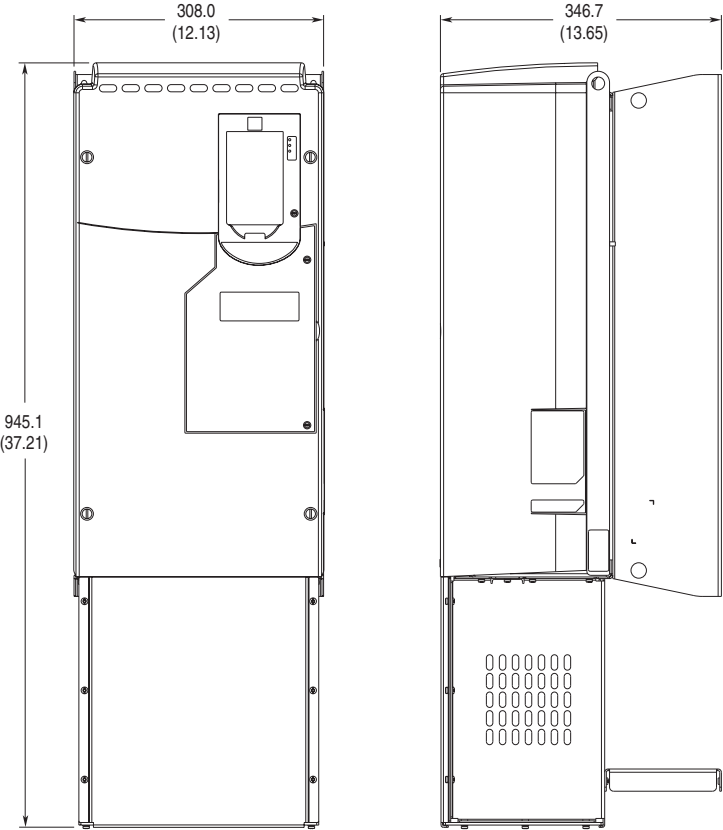
Frame	Type	Approximate Dimensions – mm (in.)																									
2...5	NEMA/UL Type 1 Kit (Frame 4 Shown)	 <table border="1" data-bbox="776 436 1401 583"> <thead> <tr> <th>Frame</th> <th>A</th> <th>B</th> <th>C</th> <th>D</th> </tr> </thead> <tbody> <tr> <td>2</td> <td>222.2 (8.75)</td> <td>497.1 (19.57)</td> <td>117.7 (4.63)</td> <td>38.0 (1.50)</td> </tr> <tr> <td>3</td> <td>223.1 (8.78)</td> <td>530.1 (20.87)</td> <td>154.7 (6.09)</td> <td>38.0 (1.50)</td> </tr> <tr> <td>4</td> <td>222.7 (8.77)</td> <td>564.4 (22.22)</td> <td>154.7 (6.09)</td> <td>40.0 (1.57)</td> </tr> <tr> <td>5</td> <td>222.7 (8.77)</td> <td>665.4 (26.20)</td> <td>155.0 (6.10)</td> <td>55.0 (2.17)</td> </tr> </tbody> </table> <p>Important: NEMA Type 1 Kits (20-750-NEMA-Fx) do not change the mounting dimensions.</p>	Frame	A	B	C	D	2	222.2 (8.75)	497.1 (19.57)	117.7 (4.63)	38.0 (1.50)	3	223.1 (8.78)	530.1 (20.87)	154.7 (6.09)	38.0 (1.50)	4	222.7 (8.77)	564.4 (22.22)	154.7 (6.09)	40.0 (1.57)	5	222.7 (8.77)	665.4 (26.20)	155.0 (6.10)	55.0 (2.17)
Frame	A	B	C	D																							
2	222.2 (8.75)	497.1 (19.57)	117.7 (4.63)	38.0 (1.50)																							
3	223.1 (8.78)	530.1 (20.87)	154.7 (6.09)	38.0 (1.50)																							
4	222.7 (8.77)	564.4 (22.22)	154.7 (6.09)	40.0 (1.57)																							
5	222.7 (8.77)	665.4 (26.20)	155.0 (6.10)	55.0 (2.17)																							
6	NEMA/UL Type 1 Kit																										

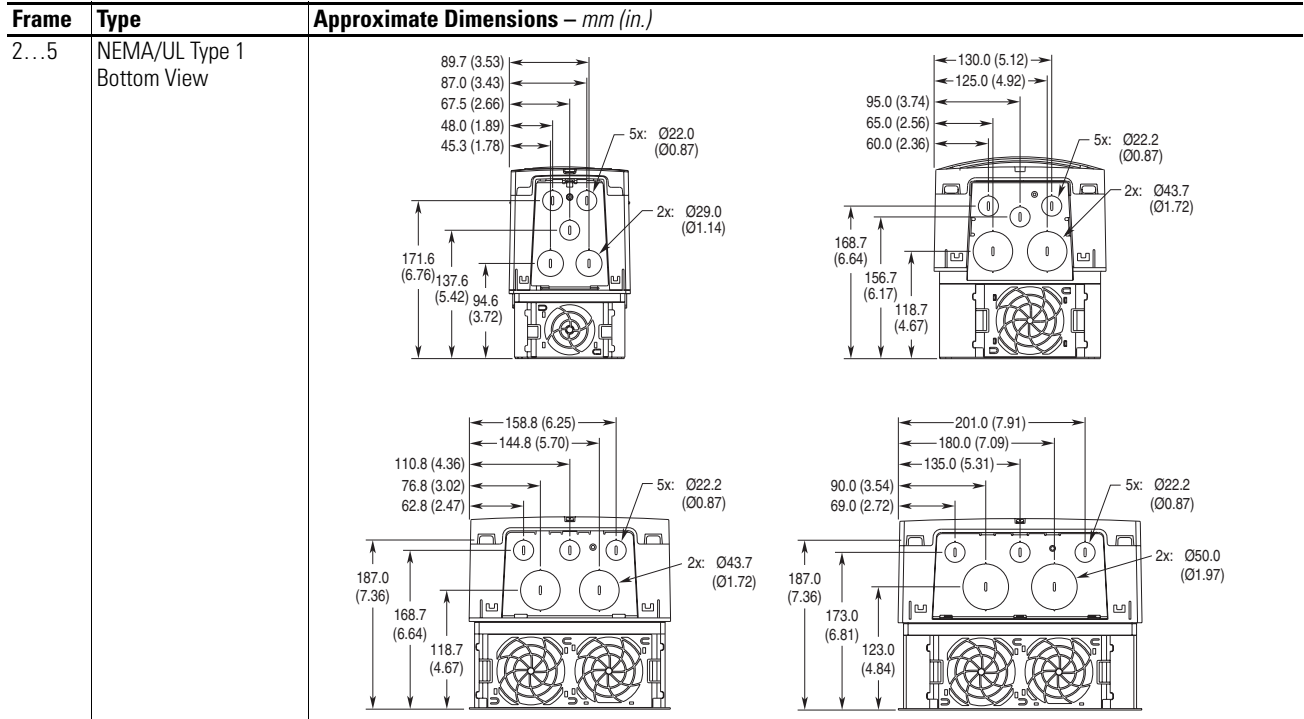

2...5 EMC Plate Kit
(Frame 4 Shown)

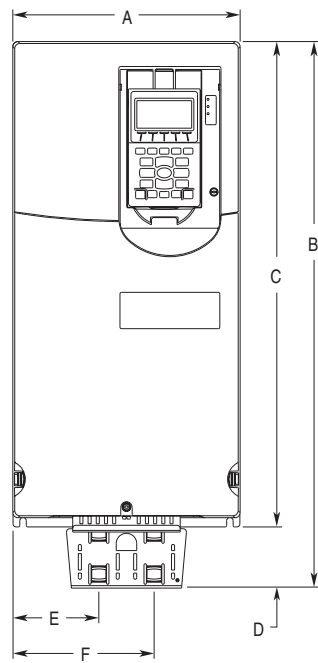

Enclosures are shown without venting. Supplied enclosures will have proper venting.

Frame	A	B	C	D	E	F
2	134.5 (5.30)	485.9 (19.13)	424.2 (16.70)	61.7 (2.43)	43.5 (1.71)	79.5 (3.13)
3	190.0 (7.48)	514.0 (20.24)	454.0 (17.87)	60.0 (2.36)	74.0 (2.91)	116.0 (4.57)
4	222.0 (8.74)	533.7 (21.01)	474.0 (18.66)	59.7 (2.35)	84.0 (3.31)	138.0 (5.43)
5	270.0 (10.63)	609.7 (24.00)	550.0 (21.65)	59.7 (2.35)	77.8 (3.06)	191.8 (7.55)

Important: EMC Kits (20-750-EMC-Fx) do not change the mounting dimensions. Refer to the PowerFlex 750-Series EMC Plate and Core(s) Installation Instructions, publication 750-IN006, for detailed information on kit installation.

Drive Options

Human Interface and Wireless Interface Modules



Blank Plate

20-HIM-A6

20-HIM-C6S

20-WIM-N1

20-WIM-N4S

Description	Cat. No.
No HIM (Blank Plate), Handheld/Local (Drive Mount)	20-HIM-A0
Enhanced, LCD, Full Numeric, Handheld/Local (Drive Mount)	20-HIM-A6
Enhanced, LCD, Full Numeric ⁽¹⁾⁽²⁾	20-HIM-C6S
Wireless Interface Module, Handheld/Local (Drive Mount)	20-WIM-N1
Wireless Interface Module, Remote (Panel Mount) ⁽¹⁾⁽²⁾	20-WIM-N4S

(1) IP66, NEMA Type 4X/12 - For indoor use only.

(2) Includes a 1202-C30 interface cable (3 meters) for connection to drive.

Specifications - Human Interface and Wireless Interface Modules

	20-HIM-A6 ⁽¹⁾	20-HIM-C6S ⁽¹⁾	20-WIM-N ⁽¹⁾	20-WIM-N4S ⁽¹⁾
Transceiver:	—	—	Bluetooth v1.1 Compliant	
Frequency:	—	—	2.4 GHz Frequency Hopping	
Power:	—	—	2.5 mW Maximum RF Output	
Range:	—	—	Class II - 10 m (32.8 ft)	
Drive Protocol:	Drive Peripheral Interface (DPI)		DPI or SCANPort	
Data Rates:	125 kbps or 500 kbps		125 or 500 Kbps (DPI only)	
Consumption Drive (DPI):	140 mA at 12V DC supplied by the Host Drive		130 mA at 12 VDC supplied by the Host Drive	
Dimensions - H x W x D	20-HIM-A6/20-WIM-N1: 116 x 70 x 16 mm (4.57 x 2.75 x 0.63 in.)			
	20-HIM-C6S/20-WIM-N4S: 180 x 93 x 25 mm (7.08 x 3.66 x 0.98 in.)			
Weight:	91 g (3.2 oz.)	173 g (5.7 oz.)	85 g (3.0 oz.)	161g (5.7 oz.)
Temperature Operating:	0...50 °C (32...122 °F)			
Storage:	-40...85 °C (-40...185 °F)			
Relative Humidity:	5...95% non-condensing			
Atmosphere:	Important: The module must not be installed in an area where the ambient atmosphere contains volatile or corrosive gas, vapors or dust. If the module is not going to be installed for a period of time, it must be stored in an area where it will not be exposed to a corrosive atmosphere.			
Vibration Operating:	2.5 G at 5...2000 Hz			
Non-Operating:	5 G at 5...2000 Hz			
Shock Operating:	30 G peak acceleration, 11 (±1) ms pulse width			
Non-Operating:	50 G peak acceleration, 11 (±1) ms pulse width			
UL	UL508C		UL508C	
cUL	CAN / CSA C22.2 No. 14		CAN/CSA C22.2 No. 14	
CE	EN61800-3		—	
C-Tick	EN61800-3		AS/NZS 4771, EN61800-3	
FCC ID	—		SNT-2XWIMNX	
IC	—		5450A-2XWIMNX	

(1) NOTE: This is a product of category C2 according to IEC 61800-3. In a domestic environment this product may cause radio interference in which case supplementary mitigation measures may be required.

Human Interface Module Accessories

Description	Cat. No.
Bezel Kit for LCD HIMs, NEMA Type 1 ⁽¹⁾	20-HIM-B1
PowerFlex HIM Interface Cable, 1 m (39 in) ⁽²⁾	20-HIM-H10
Comm Option Cable Kit (Male-Male)	
0.33 Meters (1.1 Feet)	1202-C03
1 Meter (3.3 Feet)	1202-C10
3 Meter (9.8 Feet)	1202-C30
9 Meter (29.5 Feet)	1202-C90
Cable Kit (Male-Female) ⁽³⁾	
0.33 Meters (1.1 Feet)	1202-H03
1 Meter (3.3 Feet)	1202-H10
3 Meter (9.8 Feet)	1202-H30
9 Meter (29.5 Feet)	1202-H90
DPI Cable Kit with Connectors, Tools and 100 m (328 ft.) Cable	1202-CBL-KIT-100M
DPI Cable Connector Kit	1202-TB-KIT-SET
DPI/SCANport™ One to Two Port Splitter Cable	1203-S03

(1) Includes a 1202-C30 interface cable (3 meters) for connection to drive.

(2) Required only when HIM is used as handheld or remote.

(3) Required in addition to 20-HIM-H10 for distances up to a total maximum of 10 Meters (32.8 Feet).

Communication Option Kits and Accessories

Description (see page 57 for specifications)	Cat. No.
Coaxial ControlNet™ Option Module	20-750-CNETH
ControlNet Communication Adapter (Coax)	20-COMM-C ⁽³⁾
ControlNet Communication Adapter (Coax) Conformal Coat	20-COMM-C-MX3 ⁽³⁾
DeviceNet™ Option Module	20-750-DNET
DeviceNet Communication Adapter	20-COMM-D ⁽³⁾
DeviceNet Communication Adapter Conformal Coat	20-COMM-D-MX3 ⁽³⁾
EtherNet/IP™ Communication Adapter	20-COMM-E ⁽³⁾
EtherNet/IP Communication Adapter Conformal Coat	20-COMM-E-MX3 ⁽³⁾
HVAC Communication Adapter (Only Modbus RTU can be used)	20-COMM-H ⁽³⁾
Interbus™ Communication Adapter	20-COMM-I ⁽³⁾
CANopen® Communication Adapter	20-COMM-K ⁽³⁾
Modbus/TCP Communication Adapter	20-COMM-M ⁽³⁾
PROFIBUS™ DP Communication Adapter	20-COMM-P ⁽³⁾
ControlNet Communication Adapter (Fiber)	20-COMM-Q ⁽³⁾
Remote I/O Communication Adapter	20-COMM-R ⁽³⁾
Remote I/O Communication Adapter Conformal Coat	20-COMM-R-MX3 ⁽³⁾
RS485 DF1 Communication Adapter	20-COMM-S ⁽³⁾
RS485 DF1 Communication Adapter Conformal Coat	20-COMM-S-MX3 ⁽³⁾
External Communications Kit Power Supply	20-XCOMM-AC-PS1
DPI External Communications Kit ⁽¹⁾	20-XCOMM-DC-BASE
External DPI I/O Option Board ⁽²⁾	20-XCOMM-IO-OPT1
Compact I/O™ Module (3 Channel)	1769-SM1
Serial Null Modem Adapter	1203-SNM
Smart Self-powered Serial Converter (RS232) includes 1203-SFC and 1202-C10 Cables	1203-SSS
Universal Serial Bus™ (USB) Converter includes 2 m USB, 20-HIM-H10 & 22-HIM-H10 Cables	1203-USB
ControlNet Ex Right-Angle T-Tap	1786-TPR
Communication Carrier Card	20-750-20COMM

(1) Only compatible with the following; 20-COMM-E EtherNet/IP, 20-COMM-C ControlNet (coax), 20-COMM-Q ControlNet (fiber), 20-COMM-D DeviceNet (Series B or later), 20-COMM-M Modbus/TCP.

(2) For use only with DPI External Communications Kits 20-XCOMM-DC-BASE.

(3) Requires a Communication Carrier Card (20-750-20COMM). Refer to [page 56](#) for compatibility details.

PowerFlex 755 System Resource Allocation

Some drive configurations utilizing certain communication options may exceed the available resources of the processor located on the Main Control Board. This is a consideration for PowerFlex 755 drives with revision 2 (or later) firmware. Refer to the PowerFlex 750-Series Programming Manual, publication 750-PM001 for details.

PowerFlex 750-Series Legacy Communication Options

Most legacy communication adapters (20-COMM) can be used with the PowerFlex 755. However, the restrictions stated below do apply.

It is recommended that the 20-750-20COMM Communication Carrier Card be installed in Port 6. Using Port 4 or 5 will make the adjacent left port inaccessible to other option modules and may interfere with network cable connections. For details, contact Allen-Bradley Drives Technical Support.

Adapter	Accesses Ports 1...6 for I/O	Accesses Port 7...14 Devices	Supports Drive Add On Profiles	Supports Asian-Languages ⁽⁵⁾
20-COMM-B		Not Compatible		
20-COMM-C	✓ ⁽¹⁾	✓ v3.001 ⁽³⁾	✓ ⁽⁴⁾	✓ v3.001 ⁽³⁾
20-COMM-D		Not Compatible		
20-COMM-E		✓ v4.001 ⁽³⁾	✓ ⁽⁴⁾	✓ v4.001 ⁽³⁾
20-COMM-H	✓ ⁽²⁾	Not Compatible		
20-COMM-I	✓ ⁽¹⁾	Not Compatible		
20-COMM-K		Not Compatible		
20-COMM-L		Not Compatible		
20-COMM-M	✓ ⁽¹⁾	✓ v2.001 ⁽³⁾	Not Compatible	✓ v2.001 ⁽³⁾
20-COMM-P		Not Compatible		
20-COMM-Q		✓ v3.001 ⁽³⁾	✓ ⁽⁴⁾	✓ v3.001 ⁽³⁾
20-COMM-R		Not Compatible		
20-COMM-S		Not Compatible		

- (1) Controller must be capable of reading/writing 32-bit floating point (REAL) values.
 (2) Only works in the Modbus RTU mode.
 (3) Requires this adapter firmware version or higher.
 (4) Requires firmware version v1.05 or higher of the drive Add On Profiles for RSLogix 5000 version v16 or higher.
 (5) Chinese, Japanese, and Korean languages are supported at the time of publication.

Environmental Specifications – Communication Modules

Temperature Operating:	-10...50 °C (14...122 °F)
Storage:	-40...85 °C (-40...185 °F)
Relative Humidity:	5 to 95% non-condensing
Atmosphere:	Important: The module must not be installed in an area where the ambient atmosphere contains volatile or corrosive gas, vapors or dust. If the module is not going to be installed for a period of time, it must be stored in an area where it will not be exposed to a corrosive atmosphere.

Specifications - Communication Options and Accessories

	20-COMM-C	20-750-DNET	20-COMM-D	20-COMM-E	20-COMM-H
Network Protocol: Data Rate:	ControlNet 5 Mbps	DeviceNet 125, 250, and 500 kbps	DeviceNet 125, 250, and 500 kbps	EtherNet/IP 10/100 Mbps, Half/Full Duplex	Modbus RTU, Metasys N2 or Siemens P1 FLN RTU: 4800...38400 bps N2: 9600 bps P1: 4800 or 9600 bps
Drive Protocol: Data Rates:	DPI 125 or 500 kbps	DPI 500 Kbps	DPI 125 or 500 Kbps	DPI 125 or 500 Kbps	DPI 125 or 500 Kbps
Consumption Drive (DPI): Network:	275 mA at 5V DC None	50 mA at 14V DC 60 mA at 24V DC	150 mA at 5 VDC 60 mA at 24 VDC	370 mA at 5 VDC N/A	150 mA at 5 VDC N/A
Dimensions: H x L x W	16.0 x 103.0 x 80.0 mm (0.62 x 4.00 x 3.13 in.)	68.0 x 150.0 x 26.0 mm (2.70 x 5.90 x 1.00 in.)	19.0 x 86.0 x 78.5 mm (0.75 x 3.39 x 3.09 in.)	19.0 x 86.0 x 78.5 mm (0.75 x 3.39 x 3.09 in.)	19.0 x 86.0 x 78.5 mm (0.75 x 3.39 x 3.09 in.)
Weight:	85 g (3 oz)	62 g (2.1 oz.)	85 g (3 oz)	85 g (3 oz)	85 g (3 oz)
Compliance UL: cUL: CE: C-Tick:	UL508C CAN/CSA C22.2 No. 14 EN50178 and EN61800-3 EN61800-3	UL508C CAN/CSA C22.2 No. 14 EN61800-3 EN61800-3	UL508C CAN/CSA C22.2 No. 14 EN50178 and EN61800-3 EN61800-3	UL508C CAN/CSA C22.2 No. 14 EN50178 and EN61800-3 EN61800-3	UL508C CAN/CSA C22.2 No. 14 EN50178 and EN61800-3 EN61800-3

	20-COMM-I	20-COMM-K	20-COMM-M	20-COMM-P	20-COMM-Q
Network Protocol: Data Rate:	Interbus 500 kbps	CANopen 10 kbps...1 Mbps	Modbus/TCP 10/100 Mbps, Half/Full Duplex	PROFIBUS DP 9600 bps...12 Mbps (autobauds)	ControlNet 5 Mbps
Drive Protocol: Data Rates:	DPI 125 or 500 kbps	DPI 125 or 500 kbps	DPI 125 or 500 kbps	DPI 125 or 500 kbps	DPI 125 or 500 kbps
Consumption Drive (DPI): Network:	450 mA at 5V DC N/A	500 mA at 5V DC None	350 mA at 5V DC N/A	370 mA at 5V DC N/A	275 mA at 5V DC N/A
Dimensions: H x L x W	19.0 x 86.0 x 78.5 mm (0.75 x 3.39 x 3.09 in.)	19.0 x 86.0 x 78.5 mm (0.75 x 3.39 x 3.09 in.)	19.0 x 86.0 x 78.5 mm (0.75 x 3.39 x 3.09 in.)	19.0 x 86.0 x 78.5 mm (0.75 x 3.39 x 3.09 in.)	16.0 x 103.0 x 80.0 mm (0.62 x 4.00 x 3.13 in.)
Weight:	65 g (2.3 oz)	85 g (3 oz)	85 g (3 oz)	85 g (3 oz)	85 g (3 oz)
Compliance UL: cUL: CE: C-Tick:	UL508C CAN/CSA C22.2 No. 14 EN61000-6-4 & EN61000-6-2 —	UL508C CAN/CSA C22.2 No. 14 EN61000-6-4 & EN61000-6-2 —	UL508C CAN/CSA C22.2 No. 14 EN50178 and EN61800-3 EN61800-3	UL508C CAN/CSA C22.2 No. 14 EN61000-6-4 & EN61000-6-2 EN61800-3	UL508C CAN/CSA C22.2 No. 14 EN50178 and EN61800-3 EN61800-3

	20-COMM-R	20-COMM-S	1203-SSS	1203-USB	1769-SM1
Network Protocol: Data Rate:	Remote I/O 57.6, 115.2 or 230.4 kbps	DF1 1200...38400 bps	DF1 9600...38400 bps	Universal Serial Bus (USB) 115.2 kbps	—
Drive Protocol: Data Rates:	DPI 125 or 500 kbps	DPI 125 or 500 kbps	DPI or SCANport 125 or 500 kbps (DPI only)	SCANport, DPI or DSI 125, 125/500, 19.2 kbps	DPI or SCANport 125 or 500 kbps (DPI only)
Consumption Drive (DPI): Network:	250 mA at 5V DC N/A	150 mA at 5V DC N/A	130 mA at 12V DC N/A	130 mA at 12V DC 170 mA at +5V DC (DSI)	Module:280 mA at 5V DC Channel: 60 mA at 12V DC
Dimensions: H x L x W	19.0 x 86.0 x 78.5 mm (0.75 x 3.39 x 3.09 in.)	16.0 x 86.0 x 81.0 mm (0.63 x 3.34 x 3.16 in.)	103.5 x 73.4 x 23.6 mm (4.08 x 2.89 x 0.93 in.)	103.5 x 73.4 x 23.6 mm (4.08 x 2.89 x 0.93 in.)	103.5 x 73.4 x 23.6 mm (4.08 x 2.89 x 0.93 in.)
Weight:	85 g (3 oz)	60 g (2 oz)	71 g (2.5 oz)	71 g (2.5 oz)	71 g (2.5 oz)
Compliance UL: cUL: CE: C-Tick:	UL508C CAN/CSA C22.2 No. 14 EN50178 and EN61800-3 EN61800-3	UL508C CAN/CSA C22.2 No. 14 EN50178 and EN61800-3 EN61800-3	UL508C CAN/CSA C22.2 No. 14 EN50178 and EN61800-3 EN61800-3	UL508C CAN/CSA C22.2 No. 14 EN50178 and EN61800-3 EN61800-3	UL508C CAN/CSA C22.2 No. 14 EN50081-2 and EN61000-6-2 AS/NZS 2064, 1997, Group 1, Class A

Specifications - Communication Options and Accessories (continued)

	20-XCOMM-DC-BASE	20-XCOMM-IO-OPT1	20-XCOMM-AC-PS1
Network Protocol: Data Rate:	Dependent on installed adapter Dependent on installed adapter	–	–
Drive Protocol: Data Rates:	DPI 125/500 kbps	–	–
Number of Inputs:	–	6 (single common)	–
Input Voltage Type:	–	24 VDC source load	–
Maximum Input Voltage:	–	27V DC	–
Rated Input Voltage:	–	–	100...240V AC
Operating Input Voltage:	–	–	90...264V AC
AC Input Frequency:	–	–	47...63 Hz
Maximum Input Current:	–	8 mA (each input)	–
Guaranteed ON-State Voltage:	–	10...27V DC (3 mA minimum)	–
Guaranteed OFF-State Voltage:	–	0...5V DC (2 mA maximum)	–
Reverse Polarity Protected:	–	-30V DC	–
Input Response Time:	–	25 ms + network update time ⁽²⁾	–
Number of Outputs:	–	2 relay outputs (individually isolated) 1 - Form C contacts 1 - Form A (NO) contact	–
Maximum Output Contact Voltage:	–	27V DC/125V AC	–
Maximum Output Contact Current:	–	2 A	–
Output Voltage:	–	–	24V DC
Output Current:	–	–	830 mA
Expected Contact Life:	–	1,000,000 cycles resistive at < 0.5 A 500,000 cycles inductive at < 0.5 A 500,000 cycles resistive at 1 A 300,000 cycles inductive at 1 A 300,000 cycles resistive at 2 A 150,000 cycles inductive at 2 A	–
Output Response Time:	–	25 ms + network update time ⁽³⁾	–
Consumption Module: Network:	60 mA at 12V DC supplied from drive via DPI cable Ethernet: None ControlNet: None DeviceNet: 60 mA at 24V DC	–	–
DC Power Supply Requirement	20-COMM-C: 105 mA at 24V DC ⁽¹⁾ 20-COMM-D: 60 mA at 24V DC ⁽¹⁾ 20-COMM-E: 140 mA at 24V DC ⁽¹⁾ 20-COMM-Q: 135 mA at 24V DC ⁽¹⁾ 20-COMM-M: 140 mA at 24V DC ⁽¹⁾	–	–
Dimensions (H x W x D):	108* x 108 x 75 mm (4.25 x 4.25 x 2.95 in.) with I/O terminal block attached	–	–
Weight:	340 g (12 oz)	–	–
Certifications UL cUL CE C-Tick	UL508C CAN/CSA C22.2 No. 14 – –	–	–

(1) Since the Comms Kit is powered by a nominal 24 VDC, the current consumption listed in this table differs from the value shown on the label of the communication adapter, which is based on the adapter being powered by 5 VDC from the drive.

(2) The I/O board is NOT designed for fast I/O response times. Do NOT use with input devices that will transition (OFF-ON-OFF) faster than the response time. Potential input devices include auxiliary contact inputs from relays or overloads, pushbuttons, etc.

(3) The I/O board is NOT designed for fast I/O response times. Do NOT use with output devices that need to transition (OFF-ON-OFF) faster than the response time. Potential output devices include pilot lights or a contact closure reset to another hardware device.

Feedback Options

Description	Cat. No.
Incremental Encoder	20-750-ENC-1 ⁽²⁾
Dual Incremental Encoder	20-750-DENC-1 ⁽²⁾
Universal Feedback (includes Stegmann, Heidenhain, SSI, Biss, Incremental) ⁽¹⁾	20-750-UFB-1

⁽¹⁾ PowerFlex 755 only.

⁽²⁾ Homing and registration functions are not supported when using this device with Integrated Motion. To use these functions, the Universal Feedback Board (20-750-UFB-1) must be used.

I/O Option Kits

Description	Cat. No.
24V DC I/O with 2 Analog In, 2 Analog Out, 6 Digital In and 2 Relay Outputs	20-750-2262C-2R
115V AC I/O with 2 Analog In, 2 Analog Out, 6 Digital In and 2 Relay Outputs	20-750-2262D-2R
24V DC I/O with 2 Analog In, 2 Analog Out, 6 Digital In, 3 Digital Out, 1 Relay & 2 Transistor Outputs	20-750-2263C-1R2T

Safety Options

The PowerFlex 750-Series is available with two Safety options:

- Safe Torque-Off
- Safe Speed Monitor

Safe Torque-Off is ideal for safety related applications requiring removal of rotational power to the motor without shutting down the drive. Safe Torque-Off functionality offers the benefit of quick start-up after a demand on the safety system and helps reduce wear from repetitive start-up and provides safety ratings up to and including SIL CL3, PLe, and Category 3.

In applications where the speed needs to be controlled and monitored, the Safe-Speed Monitor option combines Safe Torque-Off capability with integrated safety relay functionality and the Safe-Speed Control technology in one hardware option to provide safety ratings up to and including SIL CL3, PLe, and Category 4.

With the Safe Speed Monitor option you can safely monitor and control the speed of your application which allows operators to perform process or maintenance work without stopping the machine.

Description	Cat. No.
Safe Torque-Off	20-750-S
Safe Speed Monitor ⁽¹⁾	20-750-S1

⁽¹⁾ Requires the Dual Incremental Encoder option or Universal Feedback Option.

Specifications - Safety Options

	Safe-Torque -Off	Safe Speed Monitor
Standards:	IEC/EN60204-1, ISO13489-1, IEC 61508, IEC 61800-5-2	IEC/EN60204-1, ISO12100, IEC 61508, IEC 61800-5-2
Safety Category:	Cat. 3 and PL(e) per EN ISO 13849-1; SIL CL3 per IEC 61508 and EN 62061	Cat. 4 and PL(e) per EN ISO 13849-1; SIL CL3 per IEC 61508 and EN 62061
Power Supply (user I/O):	24V DC \pm 10%, 0.8...1.1 x rated voltage ⁽³⁾ PELV or SELV	
Power Consumption:	4.4 W	36 W
Safety Enable (SE+, SE-):	24V DC, 22 mA, short-circuit protected	–
Safety Power (SP+, SP-):	24V DC, 35 mA, short-circuit protected	–
SLS Outputs (68, 78):	–	24V DC, 50mA, short-circuit protected
SS Outputs (34, 44):	–	24V DC, 50 mA, short-circuit protected
Door Control Outputs (51, 52):	–	24V DC, short-circuit protected, 0.75 A bipolar (Power to Release/Power to Lock) configuration. 20 mA, cascading (2Ch Source) configuration.
Pulse Outputs (S11, S21):	–	24V DC, 50 mA, short-circuit protected
Pulse Inputs (S12, S22, S32, S42, S52, S62, S72, S82, X32, X42):	–	5 mA per input, max
Input ON Voltage, Minimum:	24V DC \pm 10%, 21.6...26.4V DC	15V
Input OFF Voltage, Maximum:	5V	5V
Input OFF Current, Maximum:	2.5 mA @ 5V DC	2 mA
Input-to-Output Response Time (SS_In, SLS_In, DM_In, ESM_In, LM_In):	–	20 ms
Overspeed Response Time:	–	User-configurable
Inputs (S34):	–	5 mA per input, max
Conductor Size ⁽¹⁾ :	0.3...0.8 mm ² (28...18 AWG)	0.25...2.5 mm ² (24...14 AWG)
Strip Length:	10 mm (0.39 in.)	6 mm (0.25 in.)
Terminal Screw Torque	–	0.2...0.25 N•m (1.8...2.2 lb•in)
Certification ⁽²⁾		
c-UL-us	UL Listed, certified for US and Canada.	
CE	European Union 2004/108/EC EMC Directive, and EU 2006/42/EC Machinery Directive EN 61800-3; categories C2 and C3 EN 62061; EM Immunity EN ISO 13849-1 EN ISO 13849-2 EN 61800-5-1 EN 61800-5-2 EN 61508 Parts 1-7	
C-Tick	Australian Radiocommunications Act, compliant with: EN 61800-3; categories C2 and C3	
TÜV	TÜV Certified for Functional Safety: up to SIL CL3, according to EN 61800-5-2, EN 61508, and EN 62061; up to Performance Level PL(e) and Category 3, according to EN ISO 13849-1; when used as described.	TÜV Certified for Functional Safety: up to SIL CL3, according to EN 61800-5-2, EN 61508, and EN 62061; up to Performance Level PL(e) and Category 4, according to EN ISO 13849-1; when used as described.

⁽¹⁾ Refer to Industrial Automation Wiring and Grounding Guidelines, publication 1770-4.1.

⁽²⁾ When product is marked.

⁽³⁾ Safety outputs need additional fuse for reverse voltage protection of the control circuit. Install a 6 A slow-blow or 10 A fast-acting fuse.

PowerFlex 750-Series Option Kits

Description		Frame	Cat. No.
Auxiliary Power Supply	24V Aux Power Supply	All	20-750-APS
DC Bus Bar Option Kit	DC Bus Bars	6	20-750-DCBB1-F6
		7	20-750-DCBB1-F7
		8	20-750-BUS1-F8
EMC Option Kit	EMC Plate with Core	2	20-750-EMC1-F2
		3	20-750-EMC1-F3
	EMC Plate with Cores	4	20-750-EMC1-F4
		5	20-750-EMC1-F5
	EMC Core	2	20-750-EMC2-F2
		3	20-750-EMC2-F3
	EMC Cores	4...5	20-750-EMC2-F45
		8	20-750-EMCCM1-F8
Flange Adapter Kit	Converts Open Type drive to external heatsink (flange) with NEMA/UL Type 1 integrity backside ⁽²⁾	2	20-750-FLNG1-F2
		3	20-750-FLNG1-F3
		4	20-750-FLNG1-F4
		5	20-750-FLNG1-F5
	Converts Open Type drive to external heatsink (flange) with NEMA/UL Type 4X/12 integrity backside	6	20-750-FLNG4-F6
		7	20-750-FLNG4-F7
NEMA/UL Type 1 Option Kit	NEMA/UL Type 1 Kit	2	20-750-NEMA1-F2
		3	20-750-NEMA1-F3
		4	20-750-NEMA1-F4
		5	20-750-NEMA1-F5
		6	20-750-NEMA1-F6
		7	20-750-NEMA1-F7
Roll-out Cart ⁽¹⁾	Provides a means to move the power core and allow access to the power terminals	8	20-750-CART1-F8
Remote Control POD Mounting Kit	Mounting hardware with 25 m (75 ft) fiber optic and 24V control cables for mounting the control POD in a cabinet that is separate from the drive.	8	20-750-RPD1-F8

(1) Required for Frame 8 drives to perform power wiring.

(2) This kit is for use with IP20, NEMA/UL Type 0 drives and will not provide an air-tight or water-tight seal. Where sealing is required (e.g. contaminated, dirty or wet environments), a drive with an "F" enclosure option must be used.

Internal Dynamic Brake Resistor Kits

These resistors have a limited duty cycle. Refer to the PowerFlex Dynamic Braking Selection Guide to determine if an internal resistor will be sufficient for your application. An external resistor may be required.

Drive Input Voltage	Brake Resistance (Ohms)	Frame	Cat. No.
380...480V AC	68	2	20-750-DB1-D2

Dynamic Brake, Chopper Only Kits

Voltage	Rating	Peak Transistor Current Rating (A)	Minimum DB Resistance (Ohms)	Cat. No.
380...480V AC	9A	25	37	1336-WB009
	35A	100	9	1336-WB035
	110A	400	2.5	1336-WB110

Terminators

Description (1)	Cat. No.
for use with 3.7 kW (5 Hp) & below drives	1204-TFA1
for use with 1.5 kW (2 Hp) & up drives	1204-TFB2

(1) Refer to Appendix A of publication Drives-IN001 for selection information.

Reflected Wave Reduction Modules w/Common Mode Choke

Description (1)	Cat. No.
17A with Common Mode Choke	1204-RWC-17-A

(1) Refer to Appendix A of publication Drives-IN001 for selection information.

Reflected Wave Reduction Modules

Voltage	ND kW	ND Hp	Cat. No.
380...480V AC	4	5	1321-RWR8-DP
	5.5	7.5	1321-RWR12-DP
	7.5	10	1321-RWR18-DP
	11	15	1321-RWR25-DP
	15	20	1321-RWR35-DP
	18.5	25	1321-RWR35-DP
	22	30	1321-RWR45-DP
	30	40	1321-RWR55-DP
	37	50	1321-RWR80-DP
	45	60	1321-RWR80-DP
	55	75	1321-RWR100-DP
	75	100	1321-RWR130-DP
	90	125	1321-RWR160-DP
	110	150	1321-RWR200-DP
	149	200	1321-RWR250-DP
187	250	1321-RWR320-DP	

Isolation Transformers

IP32, NEMA/UL Type 3R Standalone, 4...6% Nominal Impedance

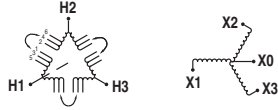

Diagram 1

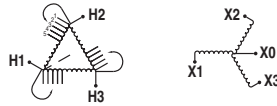

Diagram 2

460V, 60 Hz, Three-Phase, 460V Primary & 460V Secondary			
Motor Rating		Wiring Diagram	Cat. No.
kW	Hp		
0.75	1	1	1321-3TW005-BB
1.5	2	1	1321-3TW005-BB
2.2	3	1	1321-3TW005-BB
4	5	1	1321-3TW007-BB
5.5	7.5	1	1321-3TW011-BB
7.5	10	1	1321-3TW014-BB
11	15	2	1321-3TW020-BB
15	20	2	1321-3TW027-BB
18.5	25	2	1321-3TW034-BB
22	30	2	1321-3TW040-BB
30	40	2	1321-3TW051-BB
37	50	2	1321-3TH063-BB
45	60	2	1321-3TH075-BB
55	75	2	1321-3TH093-BB
75	100	2	1321-3TH118-BB
90	125	2	1321-3TH145-BB
110	150	2	1321-3TH175-BB
149	200	2	1321-3TH220-BB
187	250	2	1321-3TH275-BB
224	300	2	1321-3TH330-BB
261	350	1	1321-3TH440-BB
298	400	1	1321-3TH440-BB
336	450	1	1321-3TH550-BB
373	500	1	1321-3TH550-BB
448	600	1	1321-3TH660-BB
485	650	1	—
522	700	1	1321-3TH770-BB

Input and Output Reactors

380...480V, 50/60 Hz, Three-Phase, 3% Impedance

kW	Hp	Duty	Input Line Reactor		Output Load Reactor	
			IP00 (Open Style)	IP11 (NEMA/UL Type 1)	IP00 (Open Style)	IP11 (NEMA/UL Type 1)
			Cat. No.	Cat. No.	Cat. No.	Cat. No.
0.75	1	Normal	1321-3R2-A	1321-3RA2-A	1321-3R2-A	1321-3RA2-A
1.1	1.5	Heavy	1321-3R4-C	1321-3RA4-C	1321-3R4-B	1321-3RA4-B
1.5	2	Normal	1321-3R4-B	1321-3RA4-B	1321-3R4-B	1321-3RA4-B
		Heavy	1321-3R4-B	1321-3RA4-B	1321-3R8-C	1321-3RA8-C
2.2	3	Normal	1321-3R8-C	1321-3RA8-C	1321-3R8-C	1321-3RA8-C
		Heavy	1321-3R8-C	1321-3RA8-C	1321-3R8-B	1321-3RA8-B
4	5	Normal	1321-3R8-B	1321-3RA8-B	1321-3R8-B	1321-3RA8-B
		Heavy	1321-3R8-B	1321-3RA8-B	1321-3R12-B	1321-3RA12-B
5.5	7.5	Normal	1321-3R12-B	1321-3RA12-B	1321-3R12-B	1321-3RA12-B
		Heavy	1321-3R12-B	1321-3RA12-B	1321-3R18-B	1321-3RA18-B
7.5	10	Normal	1321-3R18-B	1321-3RA18-B	1321-3R18-B	1321-3RA18-B
		Heavy	1321-3R18-B	1321-3RA18-B	1321-3R25-B	1321-3RA25-B
11	15	Normal	1321-3R25-B	1321-3RA25-B	1321-3R25-B	1321-3RA25-B
		Heavy	1321-3R25-B	1321-3RA25-B	1321-3R25-B	1321-3RA25-B
15	20	Normal	1321-3R35-B	1321-3RA35-B	1321-3R25-B	1321-3RA25-B
		Heavy	1321-3R35-B	1321-3RA35-B	1321-3R35-B	1321-3RA35-B
18.5	25	Normal	1321-3R35-B	1321-3RA35-B	1321-3R35-B	1321-3RA35-B
		Heavy	1321-3R35-B	1321-3RA35-B	1321-3R45-B	1321-3RA45-B
22	30	Normal	1321-3R45-B	1321-3RA45-B	1321-3R45-B	1321-3RA45-B
		Heavy	1321-3R45-B	1321-3RA45-B	1321-3R55-B	1321-3RA55-B
30	40	Normal	1321-3R55-B	1321-3RA55-B	1321-3R55-B	1321-3RA55-B
		Heavy	1321-3R55-B	1321-3RA55-B	1321-3R80-B	1321-3RA80-B
37	50	Normal	1321-3R80-B	1321-3RA80-B	1321-3R80-B	1321-3RA80-B
		Heavy	1321-3R80-B	1321-3RA80-B	1321-3R80-B	1321-3RA80-B
45	60	Normal	1321-3R80-B	1321-3RA80-B	1321-3R80-B	1321-3RA80-B
		Heavy	1321-3R80-B	1321-3RA80-B	1321-3R80-B	1321-3RA80-B
55	75	Normal	1321-3R100-B	1321-3RA100-B	1321-3R100-B	1321-3RA100-B
		Heavy	1321-3R100-B	1321-3RA100-B	1321-3R100-B	1321-3RA100-B
75	100	Normal	1321-3R130-B	1321-3RA130-B	1321-3R130-B	1321-3RA130-B
		Heavy	1321-3R130-B	1321-3RA130-B	1321-3R130-B	1321-3RA130-B
90	125	Normal	1321-3R160-B	1321-3RA160-B	1321-3R160-B	1321-3RA160-B
		Heavy	1321-3R160-B	1321-3RA160-B	1321-3R160-B	1321-3RA160-B
110	150	Normal	1321-3R200-B	1321-3RA200-B	1321-3R200-C	1321-3RA200-C
		Heavy	1321-3R200-B	1321-3RA200-B	1321-3R200-C	1321-3RA200-C
149	200	Normal	1321-3RB250-B	1321-3RAB250-B	1321-3RB250-B	1321-3RAB250-B
		Heavy	1321-3RB250-B	1321-3RAB250-B	1321-3RB250-B	1321-3RAB250-B
187	250	Normal	1321-3RB320-B	1321-3RAB320-B	1321-3RB320-B	1321-3RAB320-B
		Heavy	1321-3RB320-B	1321-3RAB320-B	1321-3RB320-B	1321-3RAB320-B
224	300	Normal	1321-3RB400-B	1321-3RAB400-B	1321-3RB400-B	1321-3RAB400-B
		Heavy	1321-3RB400-B	1321-3RAB400-B	1321-3RB400-B	1321-3RAB400-B
261	350	Heavy	1321-3R500-B	1321-3RA500-B	1321-3R500-B	1321-3RA500-B
		Heavy	1321-3R500-B	1321-3RA500-B	1321-3R500-B	1321-3RA500-B
298	400	Light	1321-3R500-B	1321-3RA500-B	1321-3R500-B	1321-3RA500-B
		Normal	1321-3R500-B	1321-3RA500-B	1321-3R500-B	1321-3RA500-B
		Heavy	1321-3R500-B	1321-3RA500-B	1321-3R500-B	1321-3RA500-B
336	450	Light	1321-3R600-B	1321-3RA600-B	1321-3R600-B	1321-3RA600-B
		Normal	1321-3R600-B	1321-3RA600-B	1321-3R600-B	1321-3RA600-B
		Heavy	1321-3R600-B	1321-3RA600-B	1321-3R600-B	1321-3RA600-B
373	500	Light	1321-3R600-B	1321-3RA600-B	1321-3R600-B	1321-3RA600-B
		Normal	1321-3R750-B	1321-3RA750-B	1321-3R750-B	1321-3RA750-B
		Heavy	1321-3R750-B	1321-3RA750-B	1321-3R750-B	1321-3RA750-B

kW	Hp	Duty	Input Line Reactor		Output Load Reactor	
			IP00 (Open Style)	IP11 (NEMA/UL Type 1)	IP00 (Open Style)	IP11 (NEMA/UL Type 1)
			Cat. No.	Cat. No.	Cat. No.	Cat. No.
448	600	Light	1321-3R750-B	1321-3RA750-B	1321-3R750-B	1321-3RA750-B
		Normal	1321-3R750-B	1321-3RA750-B	1321-3R750-B	1321-3RA750-B
485	650	Light	1321-3R850-B	1321-3RA850-B	1321-3R850-B	1321-3RA850-B
		Normal	1321-3R750-B	1321-3RA750-B	1321-3R750-B	1321-3RA750-B
522	700	Light	1321-3R850-B	1321-3RA850-B	1321-3R850-B	1321-3RA850-B

380...480V, 50/60 Hz, Three-Phase, 5% Impedance

kW	Hp	Duty	Input Line Reactor		Output Load Reactor	
			IP00 (Open Style)	IP11 (NEMA/UL Type 1)	IP00 (Open Style)	IP11 (NEMA/UL Type 1)
			Cat. No.	Cat. No.	Cat. No.	Cat. No.
0.75	1	Normal	1321-3R2-B	1321-3RA2-B	1321-3R2-B	1321-3RA2-B
1.1	1.5	Heavy	1321-3R4-D	1321-3RA4-D	1321-3R4-D	1321-3RA4-D
1.5	2	Normal	1321-3R4-D	1321-3RA4-D	1321-3R4-D	1321-3RA4-D
		Heavy	1321-3R4-D	1321-3RA4-D	1321-3R8-D	1321-3RA8-D
2.2	3	Normal	1321-3R8-D	1321-3RA8-D	1321-3R8-D	1321-3RA8-D
		Heavy	1321-3R8-D	1321-3RA8-D	1321-3R8-C	1321-3RA8-C
4	5	Normal	1321-3R8-C	1321-3RA8-C	1321-3R8-C	1321-3RA8-C
		Heavy	1321-3R8-C	1321-3RA8-C	1321-3R12-C	1321-3RA12-C
5.5	7.5	Normal	1321-3R12-C	1321-3RA12-C	1321-3R12-C	1321-3RA12-C
		Heavy	1321-3R12-C	1321-3RA12-C	1321-3R18-C	1321-3RA18-C
7.5	10	Normal	1321-3R18-C	1321-3RA18-C	1321-3R18-C	1321-3RA18-C
		Heavy	1321-3R18-C	1321-3RA18-C	1321-3R25-C	1321-3RA25-C
11	15	Normal	1321-3R25-C	1321-3RA25-C	1321-3R25-C	1321-3RA25-C
		Heavy	1321-3R25-C	1321-3RA25-C	1321-3R25-C	1321-3RA25-C
15	20	Normal	1321-3R35-C†	1321-3RA35-C†	1321-3R25-C	1321-3RA25-C
		Heavy	1321-3R35-C†	1321-3RA35-C†	1321-3R35-C	1321-3RA35-C
18.5	25	Normal	1321-3R35-C	1321-3RA35-C	1321-3R35-C	1321-3RA35-C
		Heavy	1321-3R35-C	1321-3RA35-C	1321-3R45-C	1321-3RA45-C
22	30	Normal	1321-3R45-C	1321-3RA45-C	1321-3R45-C	1321-3RA45-C
		Heavy	1321-3R45-C	1321-3RA45-C	1321-3R55-C	1321-3RA55-C
30	40	Normal	1321-3R55-C	1321-3RA55-C	1321-3R55-C	1321-3RA55-C
		Heavy	1321-3R55-C	1321-3RA55-C	1321-3R80-C	1321-3RA80-C
37	50	Normal	1321-3R80-C	1321-3RA80-C	1321-3R80-C	1321-3RA80-C
		Heavy	1321-3R80-C	1321-3RA80-C	1321-3R80-C	1321-3RA80-C
45	60	Normal	1321-3R80-C	1321-3RA80-C	1321-3R80-C	1321-3RA80-C
		Heavy	1321-3R80-C	1321-3RA80-C	1321-3R80-C	1321-3RA80-C
55	75	Normal	1321-3R100-C	1321-3RA100-C	1321-3R100-C	1321-3RA100-C
		Heavy	1321-3R100-C	1321-3RA100-C	1321-3R100-C	1321-3RA100-C
75	100	Normal	1321-3R130-C	1321-3RA130-C	1321-3R130-C	1321-3RA130-C
		Heavy	1321-3R130-C	1321-3RA130-C	1321-3R130-C	1321-3RA130-C
90	125	Normal	1321-3R160-C	1321-3RA160-C	1321-3R160-C	1321-3RA160-C
		Heavy	1321-3R160-C	1321-3RA160-C	1321-3R160-C	1321-3RA160-C
110	150	Normal	1321-3R200-C	1321-3RA200-C	1321-3R200-C†	1321-3RA200-C†
		Heavy	1321-3R200-C	1321-3RA200-C	1321-3R200-C†	1321-3RA200-C†
149	200	Normal	1321-3RB250-C	1321-3RAB250-C	1321-3RB250-C	1321-3RAB250-C
		Heavy	1321-3RB250-C	1321-3RAB250-C	1321-3RB250-C	1321-3RAB250-C
187	250	Normal	1321-3RB320-C	1321-3RAB320-C	1321-3RB320-C	1321-3RAB320-C
		Heavy	1321-3RB320-C	1321-3RAB320-C	1321-3RB320-C	1321-3RAB320-C
224	300	Normal	1321-3RB400-C	1321-3RAB400-C	1321-3RB400-C	1321-3RAB400-C
		Heavy	1321-3RB400-C	1321-3RAB400-C	1321-3RB400-C	1321-3RAB400-C
		Heavy	1321-3RC400-C	—	1321-3RC400-C	—
261	350	Normal	1321-3R500-C	1321-3RA500-C	1321-3R500-C	1321-3RA500-C
		Heavy	1321-3R500-C	1321-3RA500-C	1321-3R500-C	1321-3RA500-C

kW	Hp	Duty	Input Line Reactor		Output Load Reactor	
			IP00 (Open Style)	IP11 (NEMA/UL Type 1)	IP00 (Open Style)	IP11 (NEMA/UL Type 1)
			Cat. No.	Cat. No.	Cat. No.	Cat. No.
298	400	Light	1321-3R500-C	1321-3RA500-C	1321-3R500-C	1321-3RA500-C
		Normal	1321-3R500-C	1321-3RA500-C	1321-3R500-C	1321-3RA500-C
		Heavy	1321-3R500-C	1321-3RA500-C	1321-3R500-C	1321-3RA500-C
336	450	Light	1321-3R600-C	1321-3RA600-C	1321-3R600-C	1321-3RA600-C
		Normal	1321-3R600-C	1321-3RA600-C	1321-3R600-C	1321-3RA600-C
		Heavy	1321-3R600-C	1321-3RA600-C	1321-3R600-C	1321-3RA600-C
373	500	Normal	1321-3R750-C	1321-3RA750-C	1321-3R750-C	1321-3RA750-C
		Heavy	1321-3R750-C	1321-3RA750-C	1321-3R750-C	1321-3RA750-C
522	600	Light	1321-3R750-C	1321-3RA750-C	1321-3R750-C	1321-3RA750-C
		Normal	1321-3R750-C	1321-3RA750-C	1321-3R750-C	1321-3RA750-C
485	650	Light	1321-3R850-C	1321-3RA850-C	1321-3R850-C	1321-3RA850-C
		Normal	1321-3R750-C	1321-3RA750-C	1321-3R750-C	1321-3RA750-C
522	700	Light	1321-3R850-C	1321-3RA850-C	1321-3R850-C	1321-3RA850-C

Allen-Bradley, PowerFlex, DPI, Compact I/O, SCANport and RSLogix are either trademarks or registered trademarks of Rockwell Automation, Inc. Trademarks not belonging to Rockwell Automation are property of their respective companies.

www.rockwellautomation.com

Power, Control and Information Solutions Headquarters

Americas: Rockwell Automation, 1201 South Second Street, Milwaukee, WI 53204-2496 USA, Tel: (1) 414.382.2000, Fax: (1) 414.382.4444
 Europe/Middle East/Africa: Rockwell Automation, Pegasus Park, De Kleetlaan 12a, 1831 Diegem, Belgium, Tel: (32) 2 663 0600, Fax: (32) 2 663 0640
 Asia Pacific: Rockwell Automation, Level 14, Core F, Cyberport 3, 100 Cyberport Road, Hong Kong, Tel: (852) 2887 4788, Fax: (852) 2508 1846