



**23XL
Packaged Hermetic
Screw Liquid Chillers
Stop Major
Carrier Training Service**

Familiarization • Disassembly • Reassembly

This program, Cat. No. 039-293, introduces the 23XL Screw Chiller with several new design features including: hermetic twin screw compressors, factory-mounted electro-mechanical and solid state starters and PIC controls.

In this program you will learn how to disassemble the compressor for the 23XL Screw Chiller. Topics covered are listed in the Table of Contents, which can be accessed by clicking on the Contents icon located on the lower left hand corner of each page.

"MANUFACTURER RESERVES THE RIGHT TO DISCONTINUE, MODIFY, OR CHANGE SPECIFICATIONS AND/OR DESIGNS AT ANY TIME WITHOUT NOTICE OR INCURRING OBLIGATION." Additionally, "THIS PROGRAM IS INTENDED FOR FAMILIARIZATION AND/OR TRAINING PURPOSES ONLY AND SHOULD NOT BE CONSIDERED OR TREATED AS COMPLETE INSTALLATION, SERVICE, OR TROUBLESHOOTING REFERENCES FOR SUBJECT OR OTHER PRODUCTS. CURRENT PRODUCT SPECIFIC INSTALLATION AND SERVICE LITERATURE SHOULD BE CONSULTED BEFORE ATTEMPTING THE PROCEDURES, PROCESSES, OR TECHNIQUES DESCRIBED HEREIN."



This workbook and the material contained herein are the property of Carrier Corporation and may not be copied, reproduced, or released without written permission of Carrier Corporation.

Familiarization

Compressor

Capacity Control (Slide Valve)

Economizer

Starter(s)

Pre-Disassembly Procedures

Safety Considerations

Disassembly Procedures

Motor Stator and Rotor

Outlet Casing

Bearings

Rotors

Slide Valve

Compressor Reassembly

Rotors

Outlet Casing

Measuring Clearances

Replacing Bearings

Slide Valve Assembly

Motor Rotor

Stator

Located in the back of the book are the following graphics:

Quiz

Quiz Key

Tool List

Rotor End Clearance Worksheet (Shim Sizing)

Compressor Cross Sections (3)

Slide Valve (2)

Rotor Bearings

Torque Specifications

Refrigerant — Oil Flow

Familiarization

[Click here for Figure 1 — 23XL Compressor Chiller](#)

1. In this program, you will learn how to disassemble the compressor for the Carrier 23XL R-22 Screw Compressor Liquid Chiller. It will cover a Stop Major on 23XL machine models ranging from 160 to 250 tons and includes:

- Machine familiarization
- Safety considerations
- Tools needed
- Pre-Disassembly procedures
- Disassembly procedures
- Inspecting internal parts
- Recording clearances
- Reassembly

This program will concentrate on frame size 1 and 2 machines, but it can also be used to service the frame size 4 compressor. Some frame size 4 updates you should be aware of include:

- A scaled up compressor design from 250 tons, with a choice of refrigerants R-22 or R-134a.



- Identical controls hardware.
- Controls software that is 99% unchanged.
- A radically different oil separator design—horizontal 20SA type versus vertical vortex.
- A float valve in the economizer instead of an orifice.

Installation, start-up and operation will not be covered. If you need more information, refer to the Start-up, Operation and Maintenance instructions for the 23XL which is the model designation of this machine. But first we want to introduce the unit features in this latest Carrier-designed screw compressor chiller, a major advancement in the Carrier product line. The major components consist of compressor, oil separator, condenser, cooler, and controls. This chiller uses R-22 refrigerant and has product integrated controls.

[Click here for Figure 2 — 23XL Chiller](#)

2. The 23XL chillers are being introduced in two heat exchanger frame sizes with capacities from 160 to 250 tons. The cooler is the typical flooded type, having the chilled water flowing inside the tubes and refrigerant in the shell. The cooler also provides the mounting support for the compressor, located above.

The compressor takes its suction directly from the top of the cooler, and discharges the compressed gas through a check valve, muffler, and oil separator, and then directly down into



the condenser, which is mounted behind the cooler. Liquid refrigerant flows from the bottom of the condenser back to the bottom of the cooler. All of these components are factory-mounted and piped together for ease of rigging.

[Click here for Figure 3 — Economizer](#)

3. Only certain tonnage machines are equipped with an economizer.

Economizer (Nominal Tonnage)	
<u>Without</u>	<u>With</u>
160	200
185	250
230	

The economizer is factory-mounted in the liquid line, below the cooler.



Compressor

[Click here for Figure 4 — Compressor](#)

4. The compressor consists of three basic sections. The motor is at the right end as we face the front of the unit. The center section is the compression chamber, which contains the two helical rotors. The suction gas enters at the bottom and discharges horizontally at the high pressure end of the chamber. At the left end is the capacity control mechanism, which is a piston assembly linked to the slide valve whose position determines the gas flow through the rotors. There will be either two or four solenoid valves that supply oil pressure to position the piston assembly for proper capacity.

[Click here for Figure 5 — Capacity Control Mechanism](#)

5. If there are four solenoids, it identifies a chiller with variable volume ratio control. The remainder of this program will cover a chiller with fixed volume control which has two solenoid valves.



Capacity Control

[Click here for Figure 6 — Compressor Capacity](#)

6. Compressor capacity is controlled by a hydraulically-operated slide valve. The slide valve operator is a piston/cylinder assembly. Pressurized oil fed to and bled from the assembly positions the valve.

Oil flow is controlled by the two solenoid valves. Each solenoid is operated by "load" and "unload" signals from the capacity control system.

For example, to unload the compressor, the "un-load" solenoid valve is energized and the "load" solenoid valve is de-energized. This conducts pressurized oil to the cylinder, retracting the operator shaft.

[Click here for Figure 7 — Load Signal](#)

7. On the other hand, a "load" signal de-energizes the "unload" valve and energizes the "load" valve. This bleeds oil from the cylinder to the low pressure area within the compressor housing extending the operator shaft.

And, when both solenoid valves are de-energized, the operator holds its current position.



Extension and retraction of the operator shaft "positions" the slide valve along the bottom of the rotors. The valve position controls the gas flow rate delivered by the compressor.

[Click here for Figure 8 — Valve Operating Shaft, Full Extension](#)

8. At full capacity, the valve operator shaft is extended fully, closing the valve. With the valve closed, the compressor pumps maximum gas flow, discharging through the radial and axial ports.

[Click here for Figure 9 — Operator Shaft Retraction](#)

9. At part load, the operator shaft retracts, modulating the valve toward the open position. The valve opening vents compressed gas back to suction, retarding the start of the compression process. Consequently, when compression begins, the effective compression volume has been reduced. In this way, the gas flow pumped by the compressor is modulated to balance a changing load condition.



[Click here for Figure 10 — Oil Separator](#)

10. The large vessel behind the compressor is the oil separator. The discharge gas enters at the midsection and leaves near the top, while the separated oil drops to the sump at the bottom.

The oil is stored in the bottom chamber of the separator.

During operation, oil is "pushed" from the separator by system differential pressure. Therefore, an oil pump is not required.



[Click here for Figure 11 — Condenser](#)

11. The oil from the separator flows through the filter and foreign particles are removed.

Note: Some pre-production models were equipped with a vertical oil filter. Current 23XL production machines use a horizontal oil sump/filter assembly. A portion of the oil flow is directed to the compressor bearings for lubrication. Another part of the oil is used to position the slide valve assembly. The remaining oil is injected during compression for purposes of sealing clearances between rotors. Some oil may be carried through the heat exchangers. In this event, an oil reclaim system using an eductor removes oil from the evaporator and returns it to the compressor.

[Click here for Figure 12 — Electric Heater](#)

12. You will notice that there is no oil cooler in the system. Unlike the centrifugal compressor, the screw compressor does not require oil cooling. There is, however, an electric heater in the oil separator sump, to insure the correct oil/refrigerant mixture.

Notice the sensor in the oil sump to monitor sump temperature and also to control the oil heater. There is also a low oil level switch in the oil sump.



[Click here for Figure 13 — Shell and Tube Construction](#)

13. The condenser is the familiar shell and tube construction, with cooling water flowing inside the tubes.

[Click here for Figure 14 — Float Valve](#)

14. A float valve is installed in the sump below the shell, and controls the flow of liquid refrigerant to the cooler.

[Click here for Figure 15 — Refrigerant Isolation Valves](#)

15. An important feature of this new unit is the optional refrigerant isolation valves. One valve is located in the discharge line to the condenser, and the other is in the liquid line leaving the condenser. These valves are used for transfer and isolation of the refrigerant charge in the condenser, when service work is required.

Both the cooler and condenser vessels are ASME approved with relief valves.

Motor cooling is accomplished by piping liquid refrigerant from the bottom of the condenser through a valve, a filter-dryer and a dry-eye to the motor end bell.



Economizer

[Click here for Figure 16 — Economizer Vessel](#)

16. The economizer vessel is located in the liquid line below the cooler. Some of the liquid refrigerant is allowed to vaporize at an intermediate pressure in the economizer. This removes the heat from the rest of the liquid, cooling it and increasing the cooler capacity.

The "flash" gas is injected into the compressor at an intermediate point in the compression cycle. The remaining liquid passes through an orifice and then on to the evaporator. The resulting increase in compressor power is less than the increase in cooler capacity, so the net effect is a system improvement in capacity and efficiency.

[Click here for Figure 17 — Power Panel](#)

17. The power panel contains the 115 and 230 volt control components. These include the oil heater contactor, control circuit voltage selector, low voltage transformers, and the hot gas bypass relay, if specified.



Starter(s)

[Click here for Figure 18 — Factory Mounted Starter](#)

18. The unit is available with one of two factory-mounted optional starters. One option is an electro-mechanical style.

[Click here for Figure 19 — Electro-Mechanical Starter Panel](#)

19. The electro-mechanical starter panel contains the 1CR relay, motor run contacts, starter fault contacts, motor overload contacts, and the Starter Management Module or SMM. There are also pilot relays for the chilled water pump, condenser water pump, and cooling tower fan motors.

The control panel is hinged and swings out of the way to service the starter contacts.

[Click here for Figure 20 — Solid State Starter](#)

20. The second optional starter is solid state. This starter may or may not be on your machine. This starter also uses a Starter Management Module, or SMM, to communicate with the PSIO



(Processor Sensor Input/Output) in the PIC (Product Integrated Control) control box. Amperage, voltage and operating information are relayed between the PSIO and the SMM. This operating information can be displayed on the LID (Local Interface Device).

[Click here for Figure 21 — Control Panel](#)

21. Now back to the front of the machine. The control panel is where the PIC controls are found. These are digital electronic devices that control machine operation and perform diagnostic functions, using inputs from the machine and the operator.

[Click here for Figure 22 — PIC Control Panel \(Front\)](#)

22. On the front of the PIC control panel we have a stop button, an alarm light, an LCD monitor and four function switches or softkeys.

Inside the box we find a processor module known as the PSIO (Processor Sensor Input/Output). There's room enough to add four optional modules for future requirements. To the left is a relay module. This entire box is low voltage and gets its power from the Power Panel.



[Click here for Figure 23 — Local Interface Device \(LID\)](#)

23. The Local Interface Device (LID) displays information both while the machine is running and during shutdown.

These controls will:

- Control start-up and shutdown of the chiller.
- Modulate the compressor slide valve to maintain desired chilled water temperature, and to protect against abnormal compressor conditions.
- Generate alarms and fault messages for abnormal conditions, and shut down the unit when system safety requires.
- Control unit operation per the programmed occupied/unoccupied time schedules.



Pre-Disassembly Procedures

[Click here for Figure 24 — Disassembling the Compressor](#)

24. In this section of the training program, you will learn how to disassemble the compressor for the 23XL liquid chiller.

Before starting, make sure you have all the necessary safety gear, including proper safety glasses, gloves and fire extinguisher. Be sure that all your tools and equipment are sturdy and in good working order. And for safety's sake, always lock and tag all disconnects.

If you have questions about safety procedures, read the Carrier Safety Guide before working on a 23XL machine.

Before we talk about tools, one thing you should know is that the screw compressor uses all metric dimensions and mostly metric fasteners. The heat exchangers are American standard dimensions and use English fasteners. This means you'll need some metric wrenches to do this overhaul. We'll point them out as we continue. Refer to the Torque Table in the back of this book.

Some of the tools needed are:

- Depth micrometer
- Outside micrometer 0" to 3"



- End clearance tool
- Roller bearing removal puller
- Blind collet-type bearing puller
- Inlet sleeve and bearing removal tool
- T-Bar measuring tool for end clearance check
- Rotor bearing removal tool

Additional materials needed include:

- Clean lint-free rags
- Approved compressor oil
- Replacement spare parts, new O-rings, filters etc.

Note: For a complete listing of tools needed, see the tool list in the back of this workbook.

We will store all the bolts and parts in plastic storage bags and identify the contents of each bag.

We will store all the parts in a dry, clean area, and keep them orderly so that the parts will not be lost and reassembly may be completed more rapidly and accurately.

Let's start this program by covering pre-disassembly procedures.

Pressurize and leak-test the entire unit. Look for unusual leaks that can be repaired while the compressor is being overhauled. After tagging all leaks, proceed to reclaim the refrigerant.

When you have a low ambient temperature in the equipment room, evacuate the chiller and break back the vacuum with nitrogen. This will help prevent moisture from entering and condensation from forming.



It's important to leave 1 to 2 PSI positive nitrogen pressure. Then break the refrigerant and tubing connections.

Isolate the chilled and condenser water circuits by closing the valves. Be sure the main disconnect to the compressor motor and the control panel is locked open and tagged. Opening the main disconnect will isolate the oil heater.

And remember, while the unit is open, keep the refrigerant side as clean and dry as possible. Do this by taping all openings closed with plastic material to prevent foreign materials from entering the machine. Also, oil down all compressor parts to prevent rusting.

[Click here for Figure 25 — Removing Solenoids](#)

25. We'll cover the things which must be done before you can rig the compressor casings. Identify and tag, then disconnect all control wiring that would prevent servicing the compressor. Disconnect the discharge pressure sensor.

Identify and tag each of the solenoids before removing them. Low temperature compressors have four. Remove the solenoids by using a screw driver to lift the locking cap. Slide the solenoid coil off the solenoid valve shaft.

Disconnect the capacity control solenoid's supply and return lines from the top of the slide casing. Disconnect the oil supply at the separator.

Disconnect the hanger bracket for oil lines from the outlet casing.



[Click here for Figure 26 — Motor Terminal Cover](#)

26. Remove the motor terminal cover. Identify and disconnect the main power leads. Identify and disconnect the motor sensor leads at the small terminal block.

[Click here for Figure 27 — Oil Supply Line](#)

27. Unbolt the oil supply line for the bearings and rotor. Notice that all piping connections are the mechanical compression type and a torch will not be needed. Some compressors have an economizer pipe connected to the outlet casing. Disconnect it at this time. Unbolt the eductor line at the rotor housing.

[Click here for Figure 28 — Motor Cooling Line](#)

28. Disconnect the motor cooling line at the motor end cover.

Disconnect the motor drain line at the inlet casing.

With the refrigerant removed, drain the compressor oil. Unscrew the combination oil drain and sensor port located on the bottom of the outlet housing. Use a small, shallow pan to catch the oil.



In review, section 1 covered:

- Machine Familiarization
- Safety Considerations
- Tools Needed, and
- Pre-Disassembly Procedures.



Disassembly Procedures

[Click here for Figure 29 — Compressor Disassembly](#)

29. Now we'll disassemble the compressor. To remove the slide valve assembly, first, remove 2 cap screws from the separator plate and screw in 12mm guide bolts at 9 and 3 o'clock. Remove all but two of the cap screws.

Set up the rigging. Use a nylon sling. Remove the remaining cap screws.

Screw in two jacking bolts. Apply equal pressure on each jacking bolt to bring the slide valve assembly straight out. Uneven jacking will break the dowels or castings!

[Click here for Figure 30 — Slide Valve Assembly](#)

30. Pull the slide valve assembly straight out at least two feet. When pulling the slide valve expect some oil to come out the discharge port of the outlet casing. **Be careful** so the slide valve does not drop. The valve assembly will be over-balanced. **Be very careful** that it doesn't drop and cause damage to the slide valve.

Be careful as you separate the cases because two spring-loaded Belleville washers will fall out.



[Click here for Figure 31 — Spring Retainer Assembly Removal](#)

31. Reach into the slide valve port and remove the spring retainer assembly. Move the slide valve assembly to a workbench.

[Click here for Figure 32 — Bearing Spacers](#)

32. Notice the bearing spacers in the outlet casing. Pull out the female bearing spacer. Remove the male Belleville washer if it hasn't fallen out, then remove the male bearing spacer.

[Click here for Figure 33 — Measuring Thrust or Rotor End Clearance](#)

33. Set up a dial indicator on the bearing retainer surface of the female rotor to measure the thrust or rotor end clearance.

Screw the special T-bar tool into the bearing retainer of the female rotor.

Push the rotor in and zero the dial indicator. Then pull it out. Record the rotor end clearance reading. Take the same reading on the male rotor.



[Click here for Figure 34 — Motor End Cover Removal](#)

34. Next, remove the stator and rotor. Unbolt the motor cooling line if you haven't already done so. The motor cooling line will have to be cut with a tubing cutter. Remove this line from the work area. Tape the open end.

Notice that the PIC control box is blocking the rotor and stator. Unbolt the box at the base. Two of the mounting bolts are inside the box.

Disconnect the wire from the evaporator transducer.

With the bolts removed, lift the PIC control box away from the mounting. **Be careful** not to strain the power and control wires. Move the control box toward the condenser out of the way.

Notice the wobble foot. It will need to be cut or bent out of the way. We will bend it away from the motor end cover to get the necessary clearance.

To remove the motor end cover, remove 2 motor end cover cap screws at 3 and 9 o'clock, and screw in 12mm guide bolts.

Remove the remaining cap screws.

Next, remove the motor end cover. **Be careful**. This cover has no flange and will drop. Bring it out about 4 inches or enough to get your fingers under it. Remove it from the work area.



[Click here for Figure 35 — Motor Casing Removal](#)

35. To remove the motor casing, remove two motor casing cap screws and screw in 16mm guide bolts at 9 and 3 o'clock. Set up the rigging and use a nylon strap. Remove the remaining bolts. **Be careful** because the stator is front heavy. Use jacking bolts to push the motor casing out of the inlet casing. Again, jack evenly so the dowels don't break.

Keep the motor casing as level as possible so as not to scratch the rotor or stator. The stator must be pulled out at least two feet to clear the rotor. **Be careful** not to damage terminal pins.

[Click here for Figure 36 — Motor Casing](#)

36. Move the motor casing away from the work area. For details on how to remove the stator from the motor casing refer to paragraph number 84 on page 27 of this workbook.



[Click here for Figure 37 — Rotor](#)

37. Now we'll pull the rotor.

Bend the locking tabs down and loosen the rotor locking bolt. Use a strap wrench to hold the rotor. Then remove the bolt, locking tab and rotor plate washer.

Before pulling the rotor, the holes in the rotor laminations may need to be tapped to use the rotor puller.

When using the puller, use a nylon bushing to protect the rotor shaft.

[Click here for Figure 38 — Rigging the Rotor](#)

38. Set up the rigging. Pull the rotor out, but be careful to support it, because it's very heavy. The rotor has to be pulled out at least one foot before it is off the male rotor shaft. Remove it from the work area. Remove the motor rotor key from the male rotor shaft.



Outlet Casing

[Click here for Figure 39 — Outlet Casing](#)

39. Next is the outlet casing. There's a check valve in the discharge of the outlet casing that extends into the muffler. Moving the oil separator will clear the check valve to allow removal of the outlet casing.

Drain the oil separator using a pail to catch the oil and open the service valve.

Remove the bolts that secure the oil filter assembly to the muffler.

Remove the bolts from the oil separator outlet flange.

Take the four bolts out of the bottom of the oil separator.

Disconnect the oil supply line from the bottom of the oil separator. Make preparations to catch any additional oil which may be trapped in the oil separator.

Screw an eye bolt into the top of the oil separator.

Move the rigging into place and put tension on the rigging. Remove the bolts that attach the muffler to the outlet casing.

Lift and move the separator enough to clear the check valve.

Screw one bolt into the discharge flange to help stabilize the separator.



[Click here for Figure 40 — Check Valve Flapper](#)

40. Next, pull the pin out of the check valve flapper and remove the flapper.

[Click here for Figure 41 — Guide Bolt Locations](#)

41. Now, concentrate on the outlet casing.

Set up the rigging using the eye bolt. Remove 2 bolts from the outlet casing and screw in guide bolts at 10 and 2 o'clock.

Remove the remaining bolts.

Unbolt and remove the bearing retainer plates for both the male and female rotor.

Bearings

[Click here for Figure 42 — Rotor Bearing Removal Tool](#)

42. Set up the rotor bearing removal tool on the outlet casing. Use nylon bushings to protect the rotors. Apply equal pressure on each screw. This will pull the bearings off the rotor and separate the outlet casing. **Alignment is critical. Do not cock the outlet casing!**



[Click here for Figure 43 — Outlet Casing/Rotor Casing](#)

43. Pull the outlet casing away from the rotor casing. Move it to the floor and support it with wood.

[Click here for Figure 44 — Bearings](#)

44. Now pull the bearings out by hand. The female rotor has two ball bearings and one roller bearing. These bearings only go in one way.

Use a marker to identify each bearing and the installed direction.

Remove the outer bearing spacer from the female side and mark female to identify it. Remove the inner spacer from the female rotor. Notice this spacer has a shim, which is how the rotor end clearance is adjusted.

Note: Depending on tolerances there may or may not be a shim.

[Click here for Figure 45 — Roller Bearing Puller](#)

45. The roller bearings will require a special puller. Set up the tool so it will pull the roller bearing



out of the casing. Slide the bar over the threaded rod. Then install a washer and nut. Tighten the nut to pull the roller bearing out. Inspect the bearing for damage or wear.

Now reach in and pull out the orifice ring. Notice this has an O-ring which is used as an oil seal. Notice the orifice ring has a small roll pin which is used for anti-rotation.

Rotors

[Click here for Figure 46 — Rotors](#)

46. Inspect the outlet casing. There should be no contact. Inspect the ends of the rotors. If there's any wear, it will show up on these surfaces.

Inspect the inner bearing races of the roller bearings.

Notice the small OIL FEED O-ring above the rotor.

[Click here for Figure 47 — Removing Female Rotor](#)

47. The next operation will be removing the rotors. Pull the female rotor out first. It is the one on the right. Rotate it as you pull it out. You will need a sling to lift the rotors unless you have two men. Move the female rotor to a bench and place support under the rotor shaft.



[Click here for Figure 48 — Removing Male Rotor](#)

48. Pull the male rotor out. If you're using a sling **be careful** to support the rotor because the male rotor shaft is overbalanced and may damage the shaft or fall from the rigging. It weighs approximately 200 pounds.

[Click here for Figure 49 — Supporting Removed Rotors](#)

49. Move the rotors to a bench and place support under the rotor shafts but not directly under the inner bearing race.

[Click here for Figure 50 — Rotor Inspection](#)

50. Inspect the rotors for wear or damage. Look for pitting, scratches, or unusual wear. Look at the rotors to find a contact band. Under normal conditions this band may be as wide as 8mm (5/16"). If the band is 13mm (1/2") or more you should contact your local technical representative.

Inspect the inner bearing races which are still on the rotor. Look for unusual wear.

Inspect each end of the rotor to see if it's making contact with the cases and causing wear.



[Click here for Figure 51 — Rotor Bores](#)

51. Also check the rotor bores in the rotor casing for rotor contact.

[Click here for Figure 52 — Rotor Casing Removal](#)

52. Next remove the rotor casing. Remove a cap screw at 3 and 9 o'clock and put in guide bolts. Remove the remaining cap screws. Screw in an eye bolt and attach the rigging. Use jacking bolts to separate the cases. Pull the rotor casing straight out and remove it from the work area.

[Click here for Figure 53 — Removing Female Inlet Case Bearing Sleeve](#)

53. If the female rotor bearing located in the inlet casing is to be replaced, two special tools will be needed -- an inlet sleeve and bearing removal tool and a blind hole collet-type bearing puller. Start by using these tools to pull the female inlet case bearing sleeve.

To use the blind collet-type puller, back off the bolt so the jaws are retracted. Put the tool inside the bearing sleeve and expand the jaws. Turn the nut in to pull the sleeve out.



Do not pull the sleeve and inlet bearing at the same time. Pull one at a time.

Now set up the blind puller and use this method to pull the female rotor bearing, which is also in the blind hole. Inspect the bearing for wear or damage.

This blind puller is also used for the male rotor bearing to remove both the sleeve and bearing.

Slide Valve

[Click here for Figure 54 — Slide Valve Disassembly](#)

54. Next, disassemble the slide valve. Set up rigging to support the slide casing.

CAUTION



CAUTION

Remove all the O-ring seal plugs to relieve the oil pressure.

Set up a 5-gallon pail to catch the oil, which may be a quart or more. Remove the slide valve cover cap screws. Remove the cover by carefully working it out.

Note: A two-piece casing is shown here, however, the new design slide valve assembly has a one-piece casing.

[Click here for Figure 55 — Slide Valve Rigging](#)

55. Set up the rigging on the slide cover end and rig the slide valve assembly vertical. Lower the slide valve into the pail.

Remove the bolts that secure the slide casing to the separator plate.

Use guide bolts to keep the slide casing straight. Use jacking bolts to separate the case past the dowels.

CAUTION



CAUTION

Another quart of oil will escape when the separator plate and slide valve assembly are separated. Make preparations to catch the oil. Also, loosen the supply and return pipe plugs if you haven't already done so, because the oil is still under pressure and will spray out.

[Click here for Figure 56 — Slide Casing and Piston](#)

56. Raise the slide casing up and off the piston. Inspect the seals for wear and damage. Inspect the slide bore for scratches and wear.

[Click here for Figure 57 — Capacity Rod](#)

57. Now, remove the piston from the capacity rod. Bend the lock washer tabs and remove the lock nut.

Lift the piston off the capacity rod. Notice there's an O-ring on the slide shaft to seal the piston.

[Click here for Figure 58 — Separator Plate](#)

58. Lift the separator plate straight off the capacity rod. When lifting the separator plate be careful not to scratch the capacity rod. Inspect the slide valve for wear and damage.

[Click here for Figure 59 — Slide Seal Adaptor](#)

59. Next, to remove the slide seal adapter, unscrew the four cap screws. Use two bolts to lift the adapter out of the separator plate.



In review, section 2 covered disassembly of the:

- Motor Stator & Rotor
- Outlet Casing
- Bearings
- Rotors, and
- Slide Valve



Compressor Reassembly

[Click here for Figure 60 — Compressor Reassembly](#)

60. Now we'll reassemble the compressor. Remove all the capacity control solenoid valves and plugs. Make sure the oil passageways are clean and free of dirt.

Clean and inspect all the compressor parts. Do not use solvent or compressed air to clean the bearings. Use an oil bath.

Look for scratches, damage or wear. Use Scotch Brite to polish only the rotor surfaces. **Do not** use Scotch Brite on bearing surfaces.

Clean the mating surfaces and use a flat honing stone to flatten the areas where the jacking bolts made contact with the cases.

Make sure all O-ring sealing surfaces are clean. Be sure to eliminate any high spots, gouges, or scratches.

Our next operation is replacing the roller bearings into the inlet casing. To facilitate this operation, the bearings and sleeves will need to be chilled using dry ice. The bearings and sleeves must be put into plastic bags before chilling to prevent frost build-up on the parts. This will make installation easier and prevent damage. Cool the bearings and sleeves for one-half hour or more before installation.



Clean and prepare the inlet casing to receive the bearings. Use insulated gloves to handle the bearings. Start the female rotor bearing in the bore and use a PVC tool to push and seat it in the case.

Now replace the female rotor sleeve using the same method. When the female side is complete, move to the male rotor side and replace the bearing and sleeve.

Make sure the sleeves are slightly below the machined face of the inlet casing.

[Click here for Figure 61 — Rotor Casing](#)

61. Now, the rotor casing. Use the screw compressor oil to lubricate the O-ring grooves. Place the two O-rings, small and large, into the rotor casing.

Screw guide bolts into the inlet casing at 3 and 9 o'clock.

Rig the rotor casing toward the inlet casing. Start a few cap screws. Use the cap screws to draw the two casings together. Tighten each side equally so it doesn't bind and break the dowels.

Tighten the remaining cap screws. Then tighten each cap screw with a torque wrench.



Rotors

[Click here for Figure 62 — Rotors](#)

62. We will now prepare the rotors for reassembly. If the inner bearing races on the rotor are to be replaced, support the rotor with blocks and use a double-tip torch. **Be careful** not to overheat the rotor. Use heat resistant gloves to handle the bearing races.

[Click here for Figure 63 — Heating Roller Bearings](#)

63. The replacement roller bearings must be a matched set of inner races and outer bearings. Do not mix the parts. To install the new races, heat the races in an oven or oil bath to 250°F (121°C).

Take the races out of the oil bath, one at a time, and push the race onto the rotor until it seats. Hold until it shrinks on the shaft. Use the same procedure for the other races.

[Click here for Figure 64 — Male Rotor Replacement](#)

64. The next operation will be replacing the rotors.



Oil both the male and female rotor bearings in the inlet casing. Oil the rotor bores and the slide valve bore. Set up the rigging and use a sling to lift the male rotor. Oil the male rotor lobes and bearing races. Move the rotor to the rotor casing. Carefully push the rotor in the casing. **Be careful** not to jam the rotor as you push it into the inlet casing roller bearing.

[Click here for Figure 65 — Female Rotor Replacement](#)

65. Next the female rotor. Use clean cloths and wipe the lobes. Oil the female rotor surfaces, both bearings and rotor lobes. Rig the female rotor into the rotor casing. The lobes need to mesh with the male rotor. Turn the female to match the lobes. Then turn the female into the male until it bottoms out in the roller bearing.

[Click here for Figure 66 — Rotor Measure to Housing](#)

66. Check to see if both rotors are below the machined face of the rotor housing. The height difference should be .014 to .022 inches (.35 to .55mm). Use a depth micrometer to make this measurement.



CAUTION



CAUTION

If either of the rotors are above this surface something is wrong and will have to be resolved before anything else is done.

Outlet Casing

[Click here for Figure 67 — Outlet Casing Reassembly](#)

67. To reassemble the outlet casing, clean the casing and prepare it for the bearings. Wipe out the rotor bores with a clean cloth.

Rig the outlet housing and lay it down on the large flange.

Orient the orifice rings so that the roll pins are in the oil feed passage and the rings seat into the bore correctly. Before the bearings are installed first make sure the orifice rings with O-rings are in place in the male and female bores of the outlet casing.

Now replace the roller bearing in the outlet casing. Use the dry ice and the same assembly procedures used for the inlet casing roller bearings.

Use the PVC tool to push the bearings into place and seat them. Hold each one for roughly 1 minute. Use enough force to compress the O-ring.

Then oil the O-ring grooves. Oil the O-ring, then replace both the large and small O-ring into the rotor casing.

[Click here for Figure 68 — Nylon Sleeve](#)

68. Slide a nylon sleeve onto the male and female rotors to protect the bearing surfaces. To install the outlet casing, screw in two guide bolts at 10 and 2 o'clock in the outlet casing. Oil the roller bearings.

[Click here for Figure 69 — Outlet Casing Rigging](#)

69. Rig the outlet casing and carefully work the outlet casing onto the rotor casing and guide bolts. Start a few cap screws and draw the casings together evenly. The dowels control the position of the two casings and cannot be cocked. Put in about 4 to 5 cap screws. Torque the 4 to 5 cap screws.

See if the rotors turn freely without binding and see if there is end play by pulling and pushing male rotor. Continue putting all the bolts in and torque to specifications.



Measuring Clearances

[Click here for Figure 70 — End Clearance \(Rotors\)](#)

70. Now we will measure the end clearance of the rotors.

Pull the female rotor shaft toward the outlet casing using the end clearance tool until it stops against the inner surface of the outlet housing.

We'll use a depth micrometer to take these measurements. Measure the height difference of the faces of the inner to outer races on the female rotor using the depth micrometer. First measure the outer race and record the reading. Then measure the inner race difference and record the reading.

[Click here for Figure 71 — Outer/Inner Bearing Spacer](#)

71. Choose an outer bearing spacer and scribe F (for female) on the I.D. to identify it. Use a micrometer to measure the thickness and record the measurement. Choose an inner bearing spacer. Measure the inner spacer and record the reading.

The desired inner spacer thickness can now be calculated.



[Click here for Figure 72 — Shim Calculation](#)

72. Use the [worksheet](#) in this book to determine the amount of shim to add or remove from the inner spacer to achieve the desired clearance.

When the desired clearance adjustment of .004 to .006 inches (.10 to .15mm) is complete, you can put the outer spacer in place against the roller bearing. Then the inner spacer slides over the shaft and against the inner race. Now the shim will go up against the inner spacer.

When the female side is complete, repeat the procedure for the male rotor, then put the shims and spacers in the male side.

Replacing Bearings

[Click here for Figure 73 — Outlet Casing Ball Bearings](#)

73. Now we'll replace the outlet casing ball bearings. Clean and inspect the bearings. Look for dirt or damage. Do not spin these bearings with compressed air or by hand because it will damage the bearing. Rinse the bearings in clean oil, not solvent.

Place the bearings in an oven or heated oil bath. Bring the temperature up to 250°F (121°C).

The reason for heating the bearings is that the inner race is a shrink fit on the rotor shaft and heat will expand the race.



Before replacing the bearings look at a view of an exploded assembly drawing. The female rotor has two ball bearings, which are oriented face to face. Notice how it makes contact with the bearing spacers.

The male rotor has four ball bearings. Three are oriented in the same direction and the fourth is face to face with the third.

[Click here for Figure 74 — Bearing Replacement](#)

74. Now replace the bearings. Start with the female rotor. Check the bearing orientation. Take the ball bearing out of the oil bath and push it onto the rotor. Use a PVC tool to push and seat the bearing and hold it a few seconds until it shrinks onto the shaft. Now repeat the procedure with the second bearing.

[Click here for Figure 75 — Torque Rotor Bearing Bolts](#)

75. With the female rotor bearings installed put Loctite on the bearing retainer bolts.

Place the bearing retainer on the female rotor and start the bolts.

Tighten the bolts to the proper torque. The rotor will turn so it will need to be blocked to get the proper torque. Do the same thing for the male rotor. Again check the orientation of the bearings



before installing them. Remember the male rotor has four ball bearings, each one needing to be seated using the PVC tool. With all the bearings and retainers in place, use the male rotor shaft to rotate the compressor to see if it turns freely without binding.

[Click here for Figure 76 — T-Bar Tool/Dial Indicator](#)

76. Set up the T-bar tool and a dial indicator and take an end clearance reading on each rotor. Push and pull the T-bar. It should be between .004 and .006 inches (.10 to .15mm). Record this measurement. If you get a higher or lower measurement, disassemble the bearings and recalculate inner shim thicknesses.

Slide Valve Assembly

[Click here for Figure 77 — Slide Valve](#)

77. Next we'll assemble the slide valve.

Clean all the parts and get them ready for assembly. Put the slide valve rod assembly in a pail and slide the separator plate over it.

Place thin mylar over the upright shaft. Use this method to slide the seal ring into place.

Check the seal orientation. This seals the capacity control slide valve assembly from discharge pressure. Next put the slide seal adapter on. Be sure the O-ring is in place and facing down.



Push the seal ring into the groove until it's flush. Then push the seal adapter down into the separator plate. With the plate seated, use Loctite and start the cap screws. Do not use excessive Loctite on the cap screws. Tighten these to the proper torque.

[Click here for Figure 78 — Slide Valve Piston](#)

78. Now the slide valve piston. If you're replacing the guide seal assembly, there are two seal rings; the thin one faces the separator plate. Place the thin seal ring on the piston so the open end with the spring is toward the separator plate. Check the illustration for orientation.

It may be necessary to adjust the larger seal ring. Compress it into the slot. If it doesn't fit and overlaps, trim a little off one end.

The slide valve piston assembly is placed on the shaft with the O-ring in place and the tapped bolt holes up. Now put on the lock washer and lock nut. Torque the nut. Align the nut to match a tab and bend up a tab to lock it in place.



[Click here for Figure 79 — O-Ring/Slide Valve Casing](#)

79. Now place the O-ring into the end of the slide valve casing and raise it up over the separator plate.

Place guide rods in the separator plate.

Oil the piston, bore, and shaft.

Carefully lower the slide casing over the slide valve piston. Don't damage the seals. Push the piston seals in as you lower the casing. Lower the casing on the guide rods and dowel pins and start the cap screws into the separator plate. Torque these bolts to the proper torque.

[Click here for Figure 80 — Slide Assembly](#)

80. Next, raise the slide assembly up and place it horizontally on a bench and replace the slide valve cover.

Replace the O-ring and oil it. Push the cover into place and start the cap screws. Torque the cap screws.



[Click here for Figure 81 — Slide Valve Assembly](#)

81. Next, attach the slide valve assembly to the outlet casing.

Replace the male and female rotor spacers in the outlet housing.

Use a little grease to hold the Belleville washers in place. Place the convex side of the Belleville washer out or toward the separator plate. Use a new O-ring and put it in place on the outlet casing. Screw in two guide bolts at 3 and 9 o'clock.

[Click here for Figure 82 — Slide Valve Rigging](#)

82. Rig the slide valve up and close to the compressor. Check the alignment of the slide valve. Make sure the saddle is up to match the rotors. Replace the spring retainer assembly into the capacity slide rod. Use the rigging to place the slide valve into the outlet casing.

CAUTION



CAUTION

Carefully guide the slide valve into the slide bore of the rotor casing.

Keep the slide valve as straight as possible, otherwise the spring retainer will jam. Push the slide valve assembly into the outlet casing and onto the guide bolts. Start the cap screws and tighten the cap screws evenly to draw it into place. Then torque the cap screws.

Now replace the O-ring pipe plugs in the slide casing. Replace the O-rings if needed.

Replace the oil drain plug in the outlet casing and any other plugs in the different cases.

Motor Rotor

[Click here for Figure 83 — Rotor Shaft](#)

83. Now turn the rotor shaft by hand to see if it turns freely. If there's any binding or problems it will be necessary to find out why. If applicable, replace the male inlet spacer between the motor rotor and male rotor inlet bearing race.

Now replace the motor rotor and stator. Turn the rotor keyway slot to 12 o'clock. Push the key into place. Make sure it's down into the slot. Check to see if the rotor is clean. It may be necessary to heat the rotor to get it on the shaft. Rig the rotor and heat the inside of the rotor. Use a large-tip torch. Block one end to concentrate the heat. Line up the keyway slot with the key. Push the rotor on the shaft until it stops.

Replace the rotor plate washer and rotor lock washer and bolt. Tighten the bolt to the proper torque. Use a strap wrench to hold the rotor. Bend a tab that matches a flat on the head of the bolt. Check the rotor runout using a dial indicator.



Stator

[Click here for Figure 84 — Stator Replacement](#)

84. To replace the stator, identify and disconnect the wires at the motor terminals. Remove the hollow hex plug. Remove the set screw. Use a special tool to push the round alignment key out. Set up rigging and use "C" hook special tool to rig and slide the stator out.

To install a new stator, use the "C" hook to rig the new stator. Place the round stator key into the slot. Push the stator into the motor casing until it seats. Use Loctite on the threads of the set screw and tighten it.

Connect the stator leads to the terminal pins. Double check the motor leads to make sure each lead number matches its terminal pin number. Use two wrenches to make these connections tight. Do not tighten inner nut against insulator of terminal pin.

[Click here for Figure 85 — Motor Casing](#)

85. To replace the motor casing, raise the motor casing using a sling. Oil and replace the O-ring. Set up guide bolts at 9 and 3 o'clock. Rig the motor casing into place using the guide bolts. Replace the cap screws and screw all the bolts evenly because of the dowel pins. Tighten to the proper torque.



[Click here for Figure 86 — Compressor](#)

86. Turn the compressor over by hand. Use feeler gauges to check the air gap. It should be .038 to .047 inches (.97 to 1.19mm). Before replacing the motor end cover use a megohmmeter to check motor resistance. Also megger each of the leads to ground.

[Click here for Figure 87 — Motor End Cover O-Ring](#)

87. If everything is OK replace the motor end cover O-ring. Use guide bolts at 9 and 3 o'clock. Lift or rig the motor end cover into place. Push it over the guide bolts and start the cap screws. Tighten these cap screws.

[Click here for Figure 88 — Completed Chiller Assembly \(Front View\)](#)

88. To complete this compressor overhaul:

- Install the check valve flapper and connect the oil separator.
- Connect all flanges, pipes, tubing, conduit, and electrical connections.
- Change refrigerant filters, (if any).



- Perform leak testing.
- Add a new charge of compressor oil.
- Perform "Machine Dehydration"
- Replace the insulation, (if needed).
- Recharge the machine, and return the machine to normal operating conditions.

[Click here for Figure 89 — Completed Chiller Assembly \(Rear View\)](#)

89. In review, section 3 covered:

- Reassembly of the Rotors
- Measuring Clearances
- Replacing Bearings
- Reassembly of the Slide Valve
- Installation of the Motor Rotor and Stator

This completes our coverage of Carrier's 23XL Screw Compressor Liquid Chiller Stop Major. In this program we covered:

- Machine Familiarization
- Safety Considerations
- Tools Needed
- Pre-Disassembly Procedures
- Disassembly Procedures



- Inspecting the Internal Parts
- Recording Clearances, and
- Reassembly

We hope this program goes a long way to help you understand the 23XL machine, and how to service it.



[Click here for Rotor End Clearance Worksheet](#)

[Click here for 23XL Casings — Male Side View](#)

[Click here for 23XL Casings — Top Sectional View](#)

[Click here for 23XL Casings — Top View and Female Side View](#)

[Click here for Slide Valve Assembly — Two Piece Casing Shown](#)

[Click here for Slide Casing \(Internal and External\)](#)



[Click here for Rotor Bearings](#)

[Click here for 200 Ton Screw Compressor Torque Specification Chart for Metric and American Fasteners](#)

[Click here for Refrigerant — Oil Flow Schematic](#)



Quiz

Familiarization

1. True or False. The PIC controls and the slide valve provide capacity control for the screw compressor chiller.
2. The screw compressor uses all _____ dimensions and fasteners and heat exchanger fasteners are _____ standard dimensions.
3. True or False. During operation, oil is pushed from the oil separator to the compressor bearings and slide valve by system differential pressure.
4. True or False. For start-up, an auxiliary oil pump is used to provide pre-start lubrication.
5. The 23XL cooler is the typical flooded-type having:
 - a. water in the shell and refrigerant in the tubes.
 - b. water in the tubes and refrigerant in the shell.
 - c. neither of the above.
6. The economizer is used to:
 - a. vaporize some of the liquid refrigerant in order to cool the remaining liquid.
 - b. Superheat liquid refrigerant and inject it into the first stage.
 - c. not available on the 23XL.



7. The starter uses a Starter Management Module or _____ to communicate with the _____ in the _____ control box.
- SMM, SMAC, LID
 - SMM, operator, high voltage
 - SMM, PSIO, PIC
 - SMM, PSIO, CNN
8. True or False. The 23XL compressor uses hot gas bypass for surge protection.
9. Amps, volts, and operating information are relayed between the PSIO and the _____.
10. True or False. The 23XL compressor has an oil cooler which is mounted directly to the compressor.
11. True or False. The purpose of the oil heater in the separator is to ensure the correct oil/refrigerant mixture.
12. Low temperature, variable volume ratio control compressors contain _____ slide valve (capacity control) solenoid valves.
- two
 - four
 - six
 - none



Disassembly Procedures

13. When removing the slide valve assembly, you will probably find _____ coming from the discharge port of the outlet casing.

- a. refrigerant
- b. oil
- c. grease

14. True or False. When removing the motor, the stator is pulled before the rotor is removed.

15. There is a _____ in the discharge of the outlet casing that extends into the muffler.

- a. oil seal
- b. noise attenuator
- c. check valve
- d. pressure tap

16. The male rotor has _____ ball bearings and _____ cylindrical roller bearing(s) in the outlet casing.

- a. two, one
- b. four, two
- c. three, three
- d. four, one



17. The female rotor has _____ ball bearings and _____ cylindrical roller bearing(s) in the outlet casing.

- a. two, one
- b. four, two
- c. three, three
- d. four, one

18. If there is any wear on the rotors, it will show up on the _____ and _____ surfaces.

- a. lobes
- b. journals
- c. ends
- d. bores

19. True or False. When removing the rotors, always remove the male rotor first.

20. Before the slide valve assembly and separator plate are separated, be sure to remove the supply and return _____ _____ to relieve pressure from the oil.



Compressor Reassembly

21. Before re-assembling the rotors, polish any scratches with _____.
- emery cloth
 - Scotch Brite
 - polishing compound
 - Mr. Rub-Dub
22. To facilitate re-assembly of the roller bearings in the inlet casing, the bearings and sleeves should be _____.
- heated
 - chilled
 - lubricated
23. True or False. If the inner bearing races of the rotors are to be removed, they should be heated with a double tip torch.
24. The new inner bearing races of the rotors must be heated to _____ °F in an oven or oil bath prior to assembly.
25. True or False. When re-assembling the rotors, the male rotor is assembled first.
26. True or False. After the rotors are re-installed, check to see if both rotors are below the machined face of the rotor housing. The height difference should be .014 to .022 inches.



27. True or False. The outlet casing roller bearings are re-assembled using the same technique as for the inlet casing bearings.

28. The proper end clearance for the rotor is _____ to _____ inches and is obtained by installing _____.

29. True or False. The outlet casing ball bearings must be chilled for at least one half hour before re-assembling them.

30. True or False. It may be necessary to heat the motor rotor in order to get it installed on the shaft.

31. The motor air gap after reassembly should be from _____ to _____ inches.

a. .038, .047

b. .020, .030

c. .017, .037



Tool List

- A Gantry or adequate rigging
- 2-ton chain fall
- Guide bolts
- A temperature stick 225-250°F
- Two 16mm x 3cm long flush mount eye bolts
- Depth micrometer (6-inch head)
- Dial indicator with a magnetic base (.001 inch graduations)
- Large snap ring pliers
- Punch set
- Outside micrometer 0" to 3"
- Double-tipped torch
- Assortment of sleeves and shaft protectors
- Plastic hammers
- A suitable set of open end wrenches
- Torque wrenches 0-50 and 0-200 ft.-lbs.
- Nylon slings
- Universal swivel sockets - 1/2 and 3/8 inch drive
- Socket set 6-19mm
- Allen wrenches 2-19mm
- Socket Allen wrenches 2-19mm
- End clearance tool



- Roller bearing removal puller
- Blind collet-type bearing puller
- Inlet sleeve and bearing removal tool
- Rotor bearing removal tool
- Tiffin strips
- T-Bar measuring tool for end clearance check (make up locally)
- Motor rotor removal tool (puller)
- Tap 1/2 - 13 UNC
- O-ring grease
- Feeler gauges
- Megohmmeter
- "C" hook stator tool
- Stator alignment key push tool
- PVC tool
- Jacking bolts

Additional Materials:

- O-rings and filters
- Loctite
- Oil
- Dry ice
- Scotch Brite



23XL Quiz Key

Answer

Paragraph

Familiarization

1. True	23
2. metric, American	24
3. True	10
4. False	10
5. b	2
6. a	16
7. c	19, 20
8. False	14, 15
9. SMM	20
10. False	12
11. True	12
12. b	4, 5



Answer

Paragraph

Disassembly Procedures

13. b	30
14. True	35
15. c	39
16. d	44
17. a	44
18. a, c	50
19. False	47
20. pipe plugs	54

Compressor Reassembly

21. b	60
22. b	60
23. True	62
24. 250°F	63
25. True	64



Answer

Paragraph

Compressor Reassembly (Continued)

26. True	66
27. True	67
28. .004, .006, shims	72
29. False	73
30. True	83
31. a	86



[Click here for Rotor End Clearance Worksheet](#)

[Click here for 23XL Casings — Male Side View](#)

[Click here for 23XL Casings — Top Sectional View](#)

[Click here for 23XL Casings — Top View and Female Side View](#)

[Click here for Slide Valve Assembly — Two Piece Casing Shown](#)

[Click here for Slide Casing \(Internal and External\)](#)



[Click here for Rotor Bearings](#)

[Click here for 200 Ton Screw Compressor Torque Specification Chart for Metric and American Fasteners](#)

[Click here for Refrigerant — Oil Flow Schematic](#)



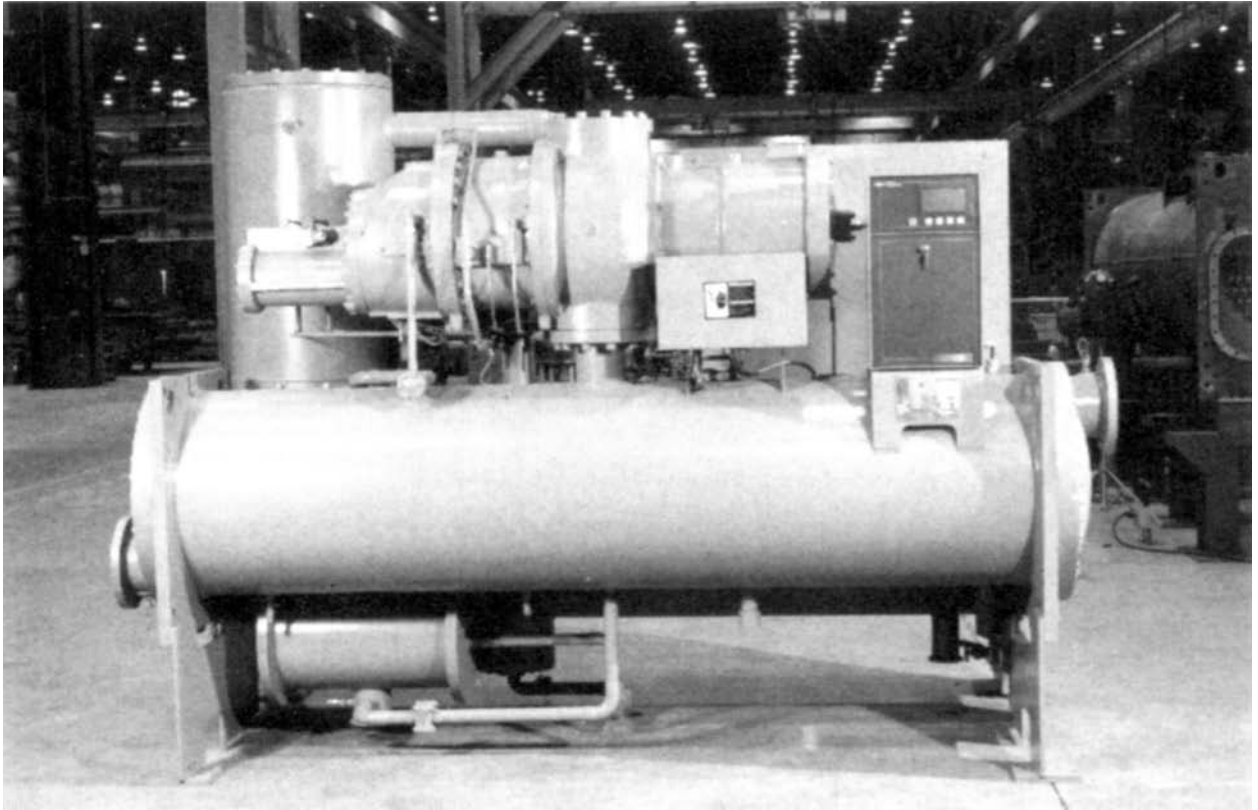

Figure 1 — 23XL Compressor Chiller

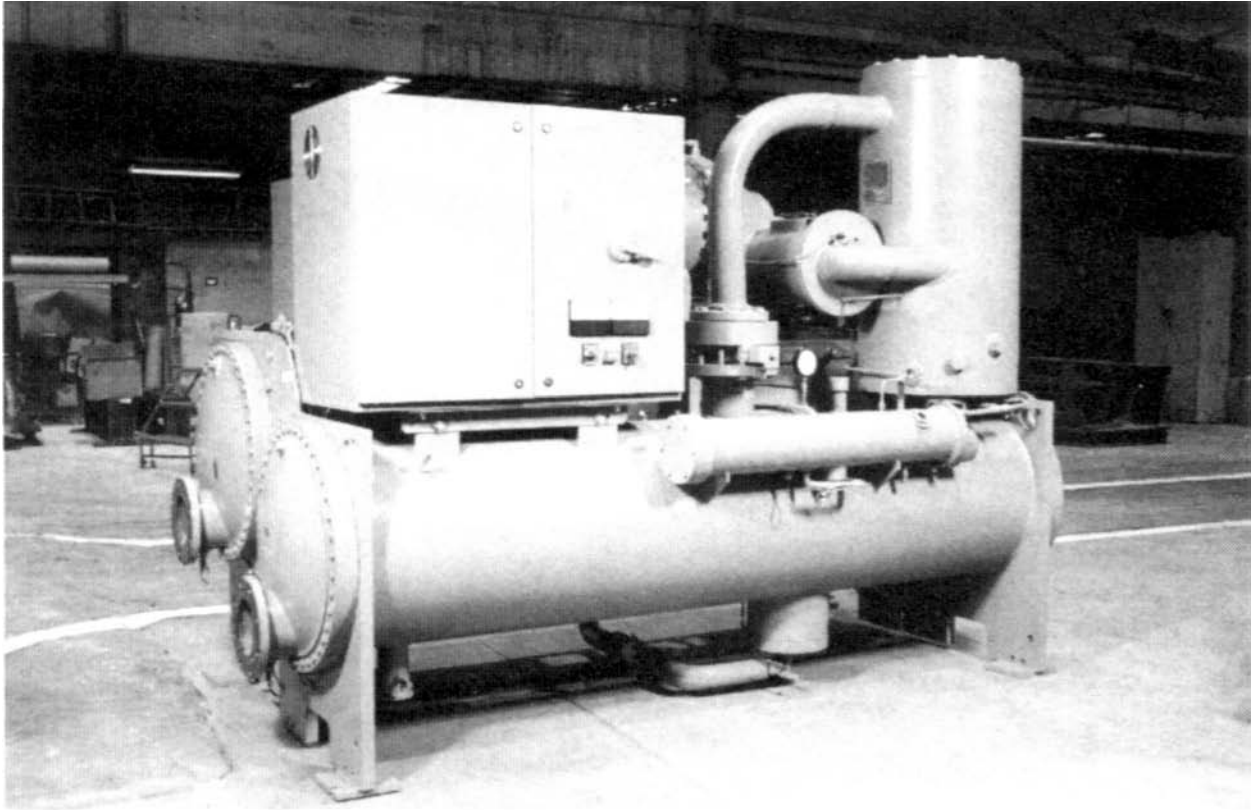

Figure 2 — 23XL Chiller

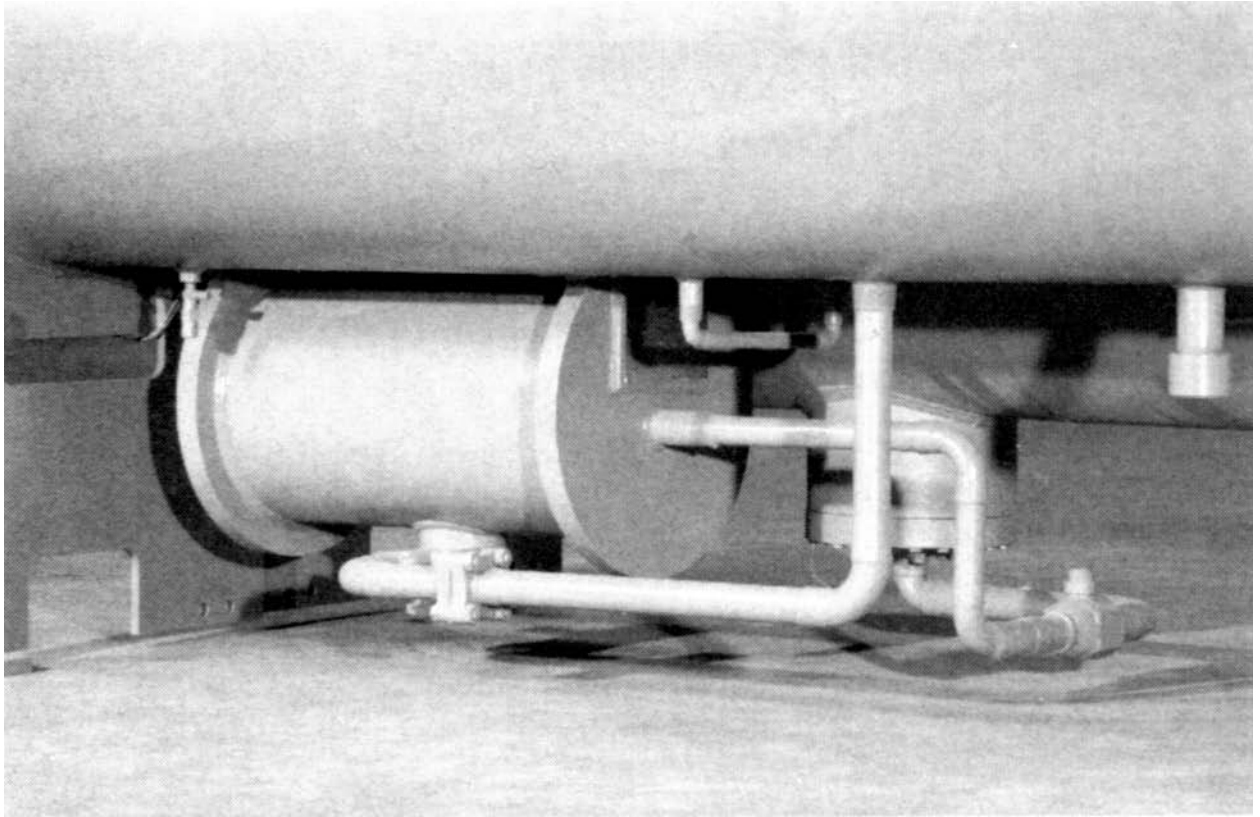

Figure 3 — Economizer

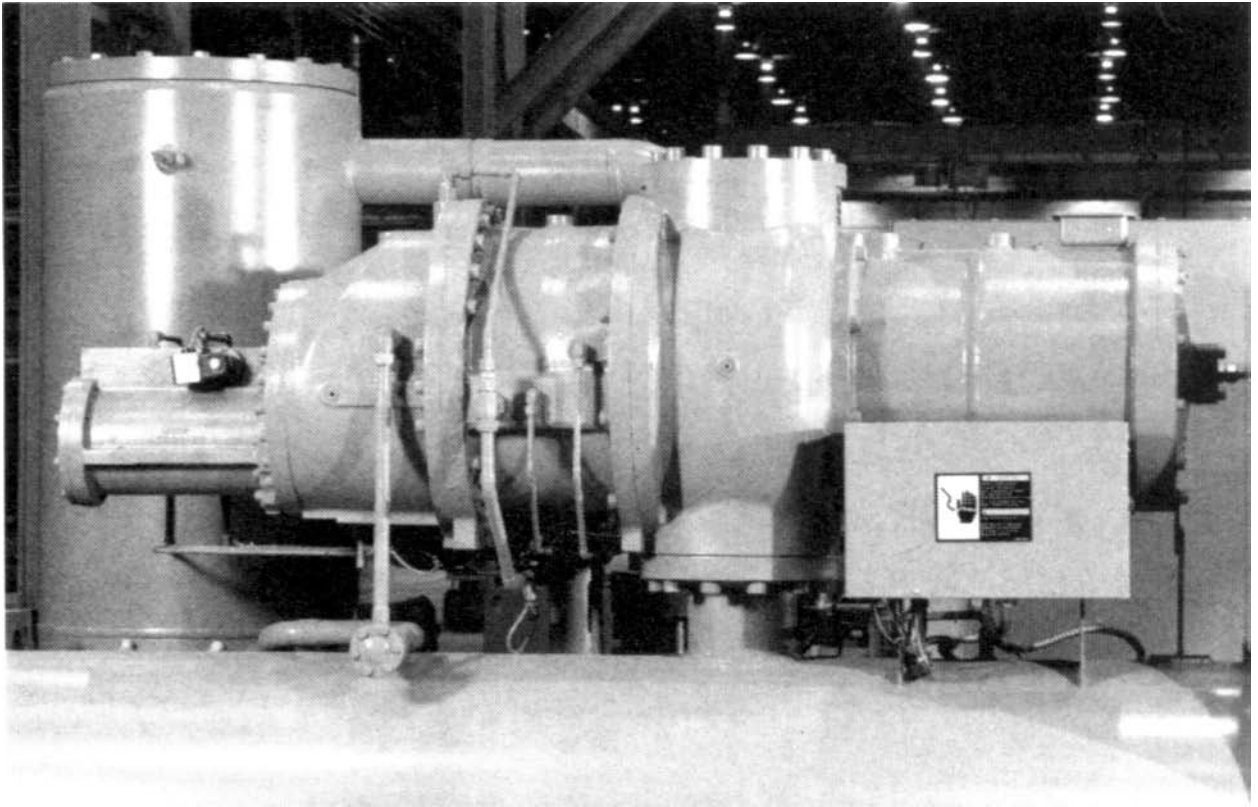

Figure 4 — Compressor

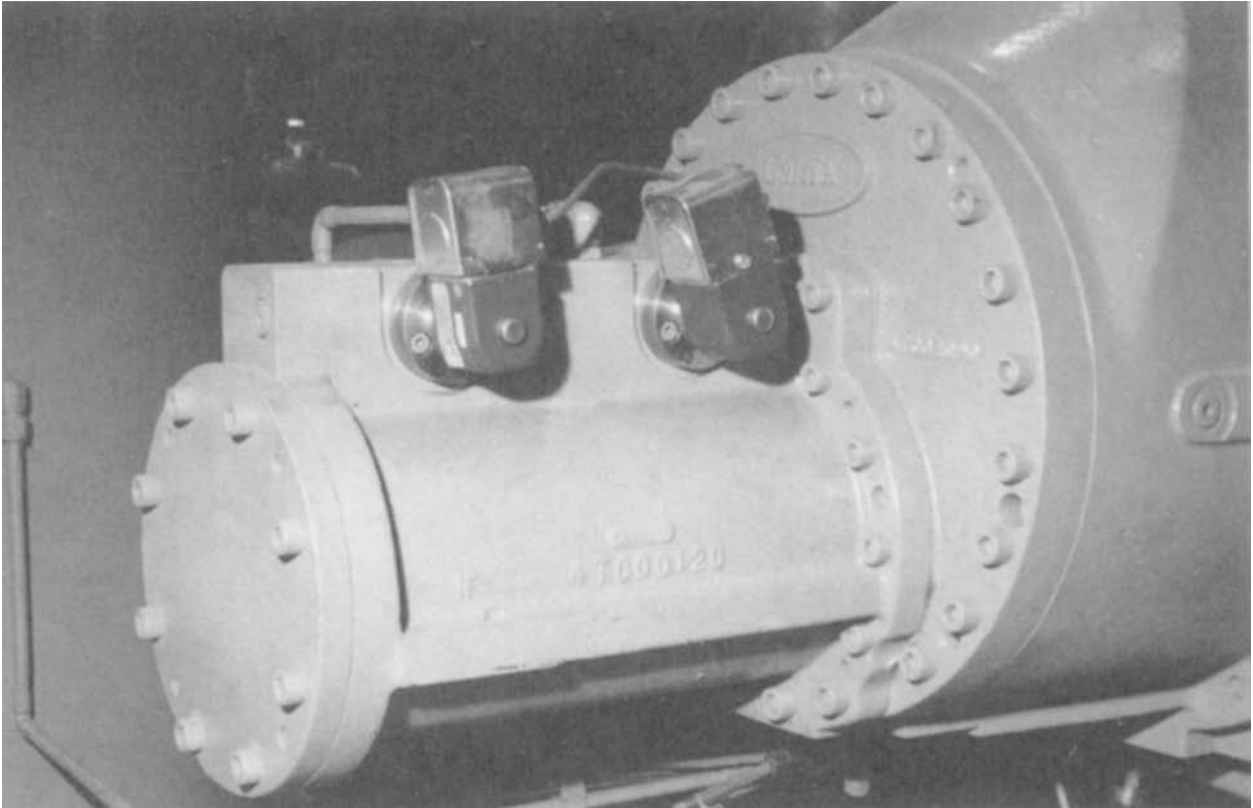

Figure 5 — Capacity Control Mechanism

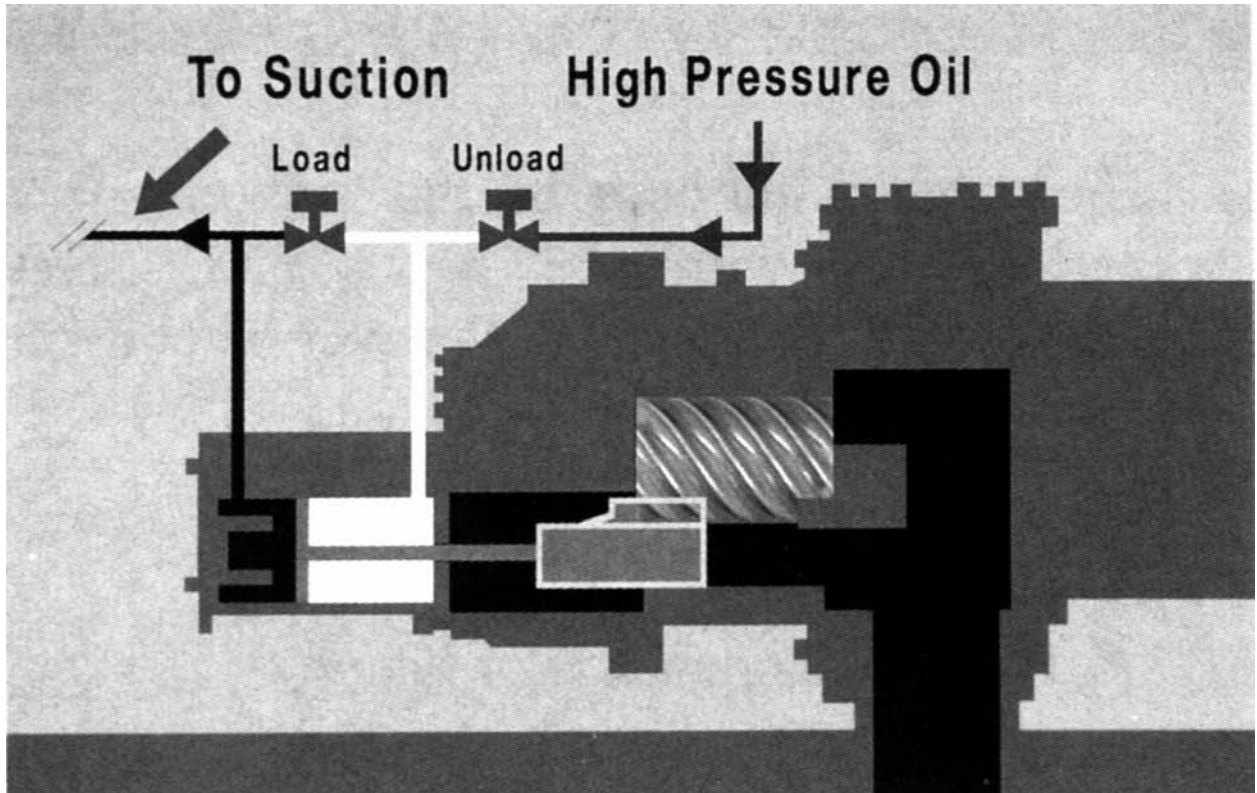

Figure 6 — Compressor Capacity

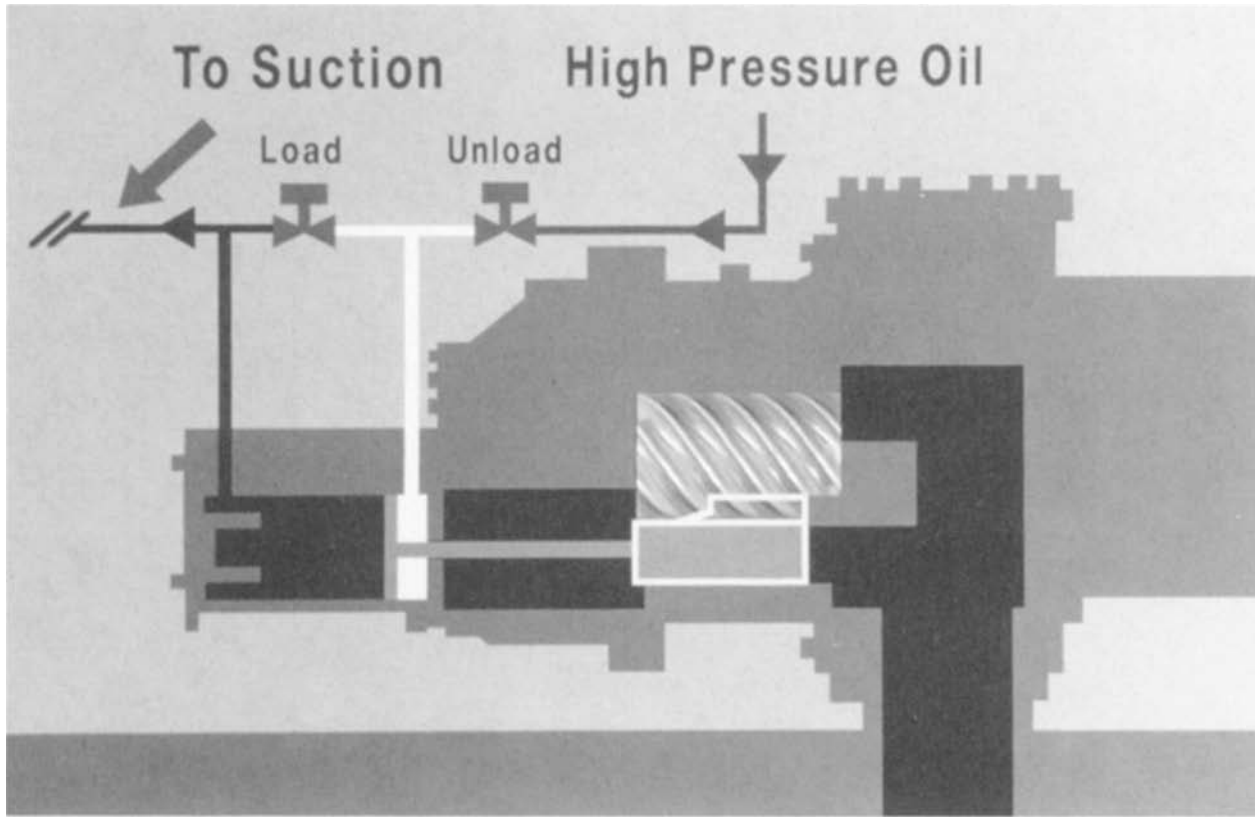

Figure 7 — Load Signal

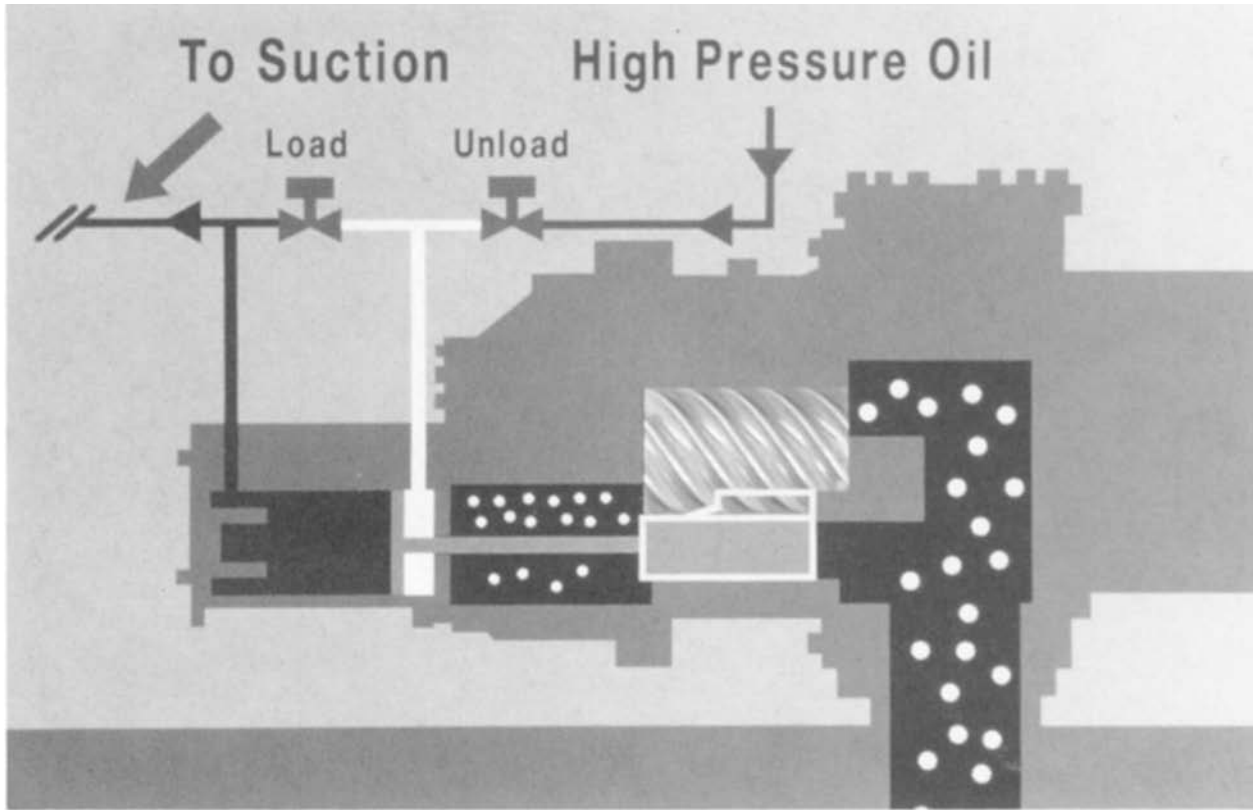

Figure 8 — Valve Operating Shaft, Full Extension

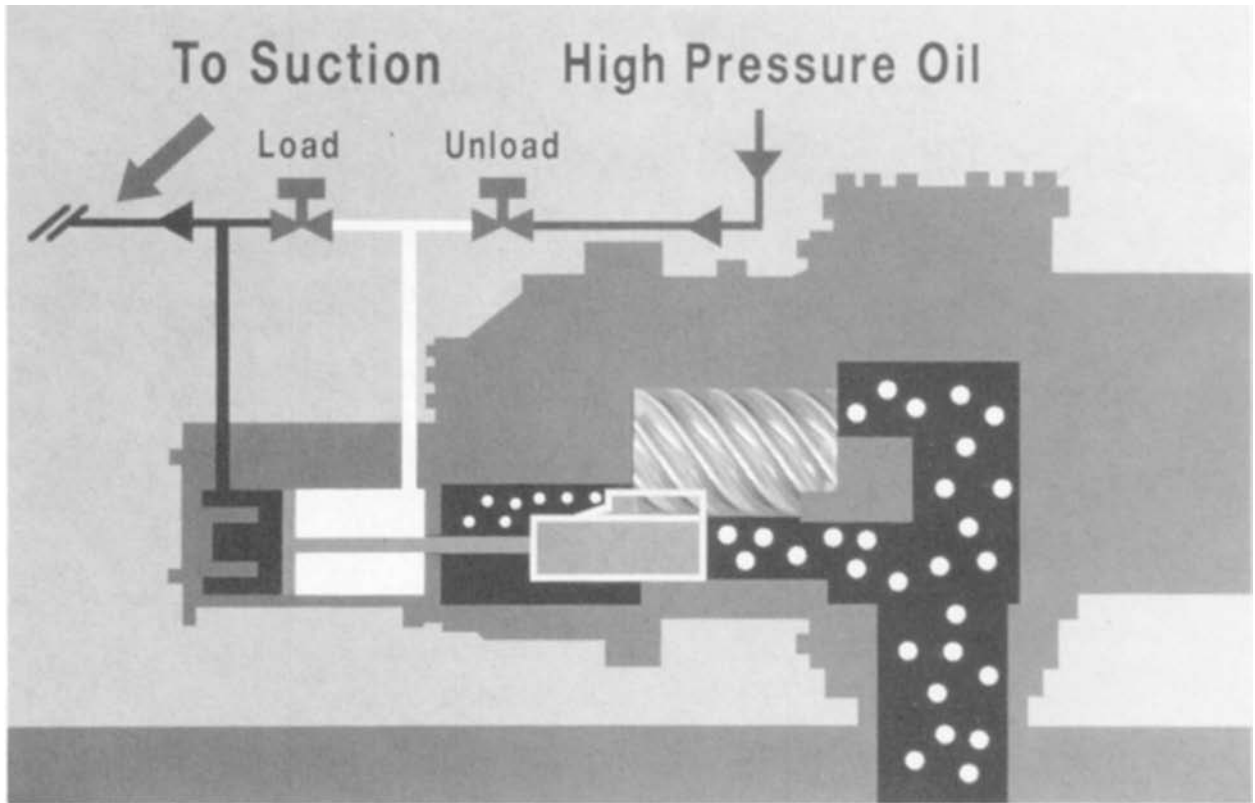

Figure 9 — Operator Shaft Retraction

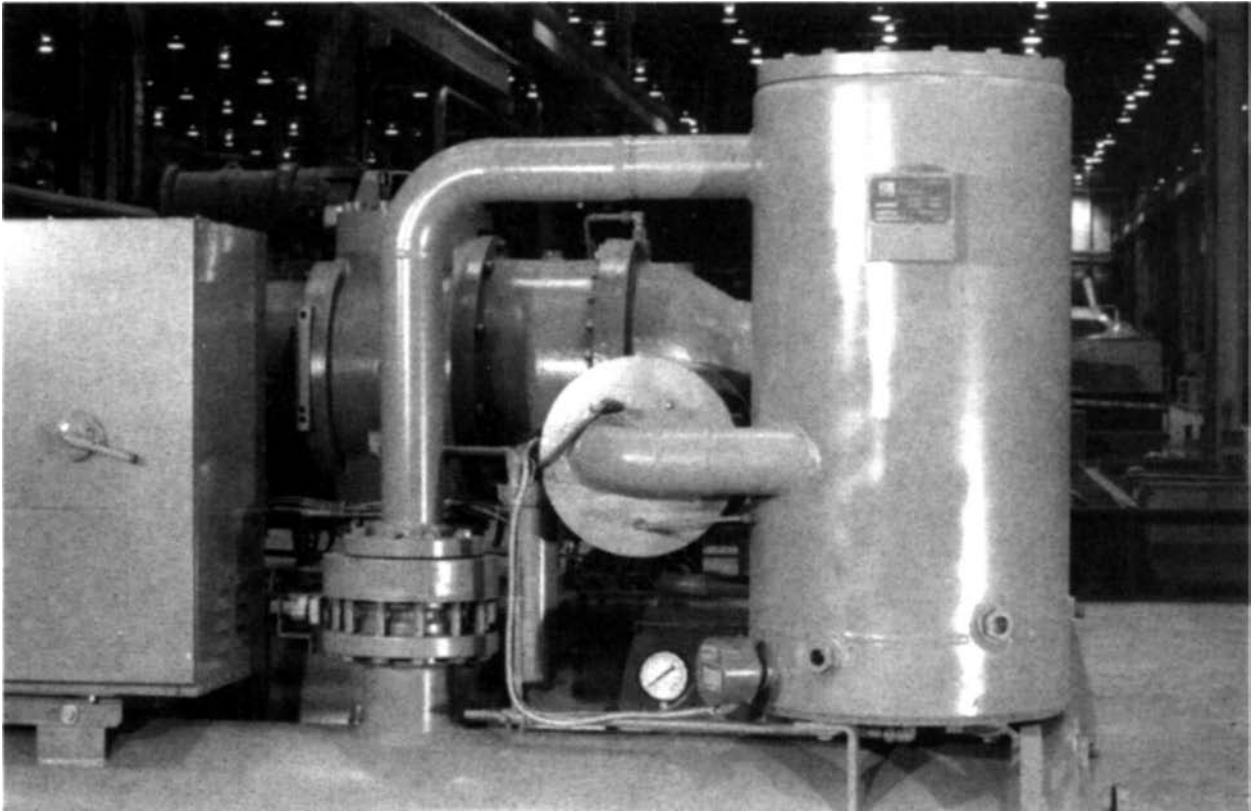

Figure 10 — Oil Separator

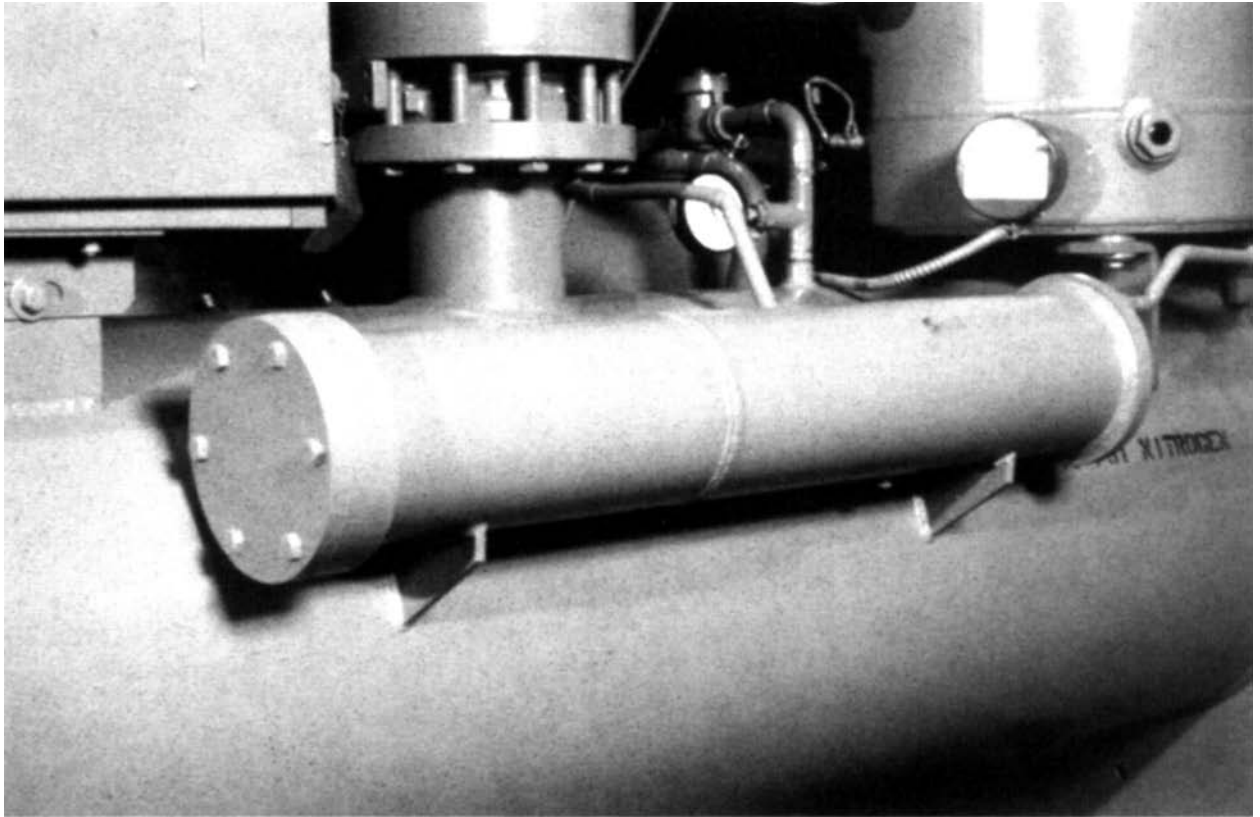

Figure 11 — Condenser



Figure 12 — Electric Heater

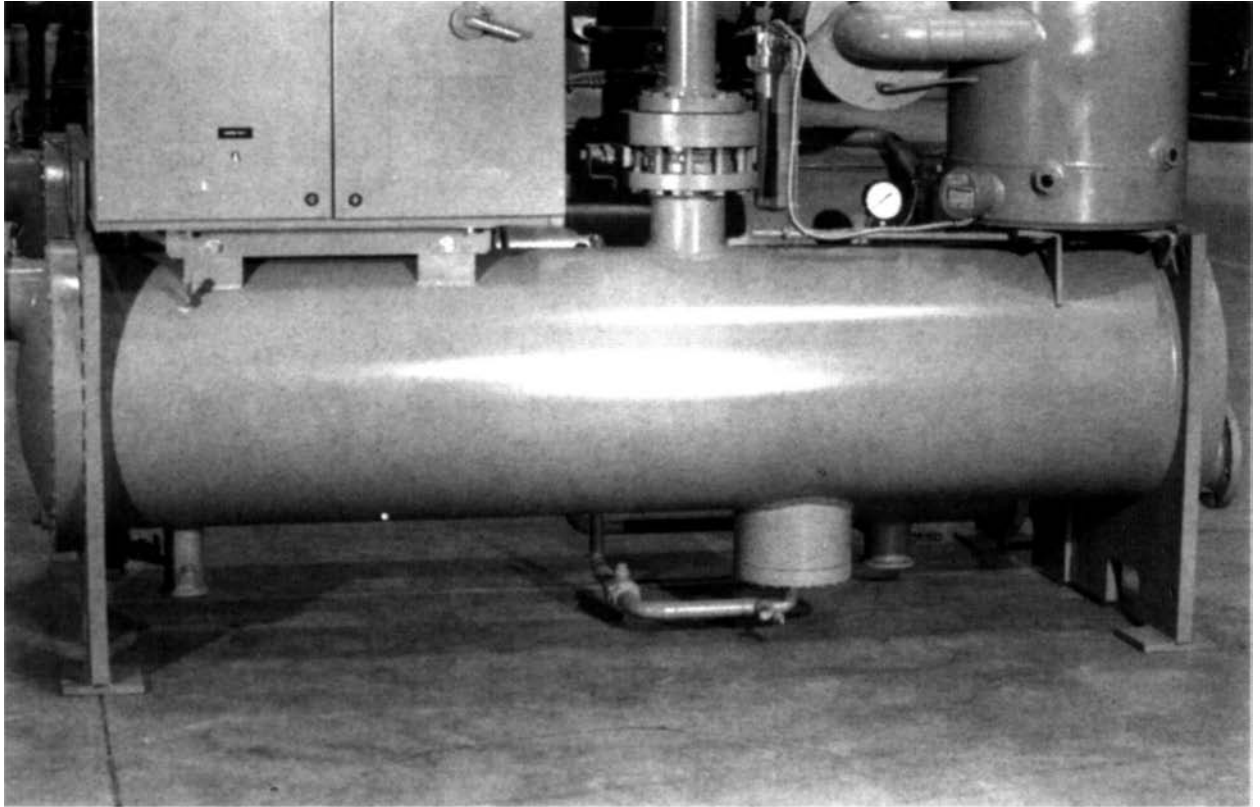

Figure 13 — Shell and Tube Construction

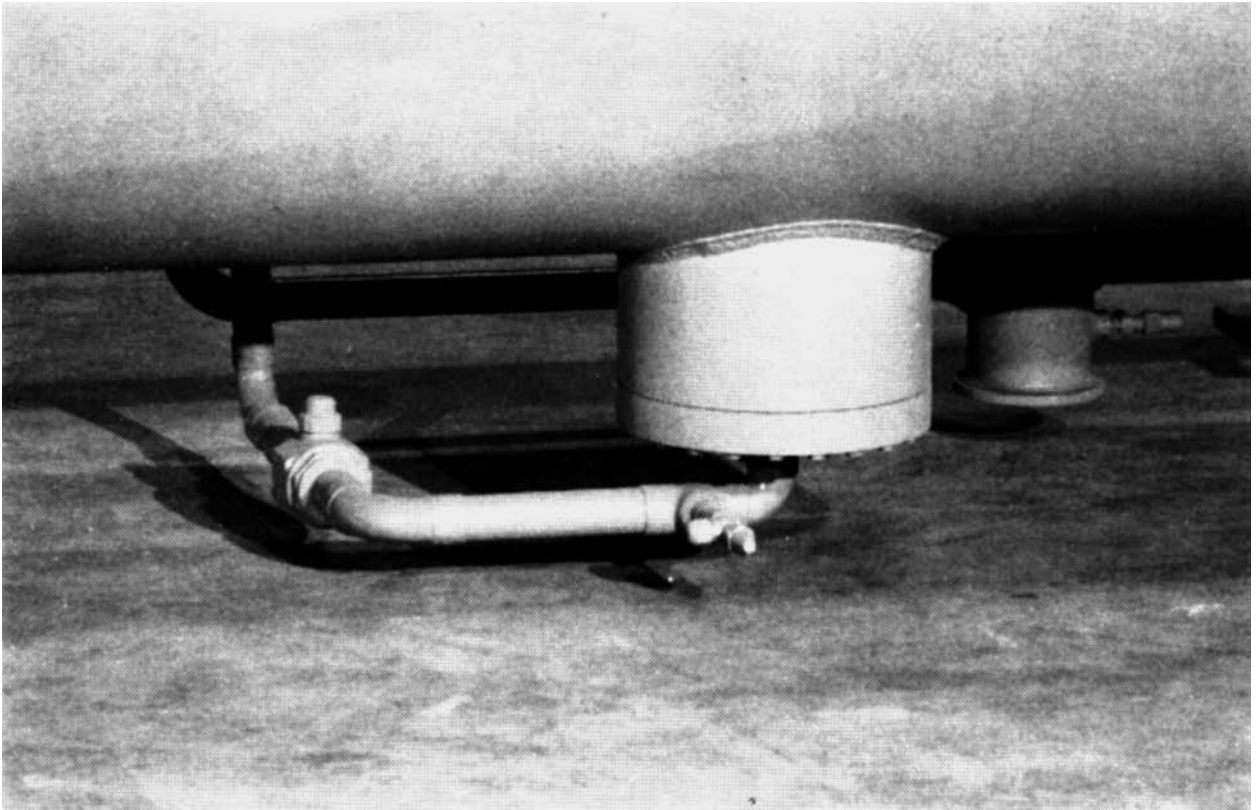

Figure 14 — Float Valve

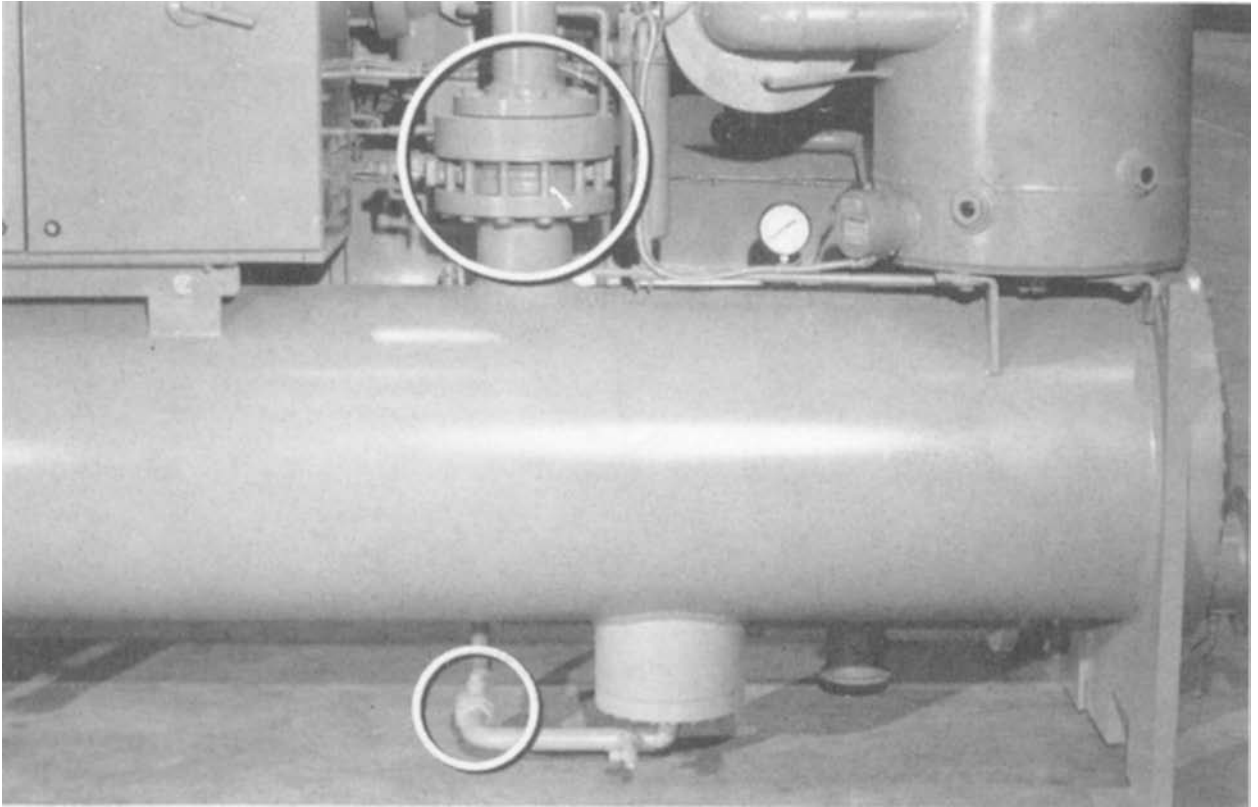

Figure 15 — Refrigerant Isolation Valves

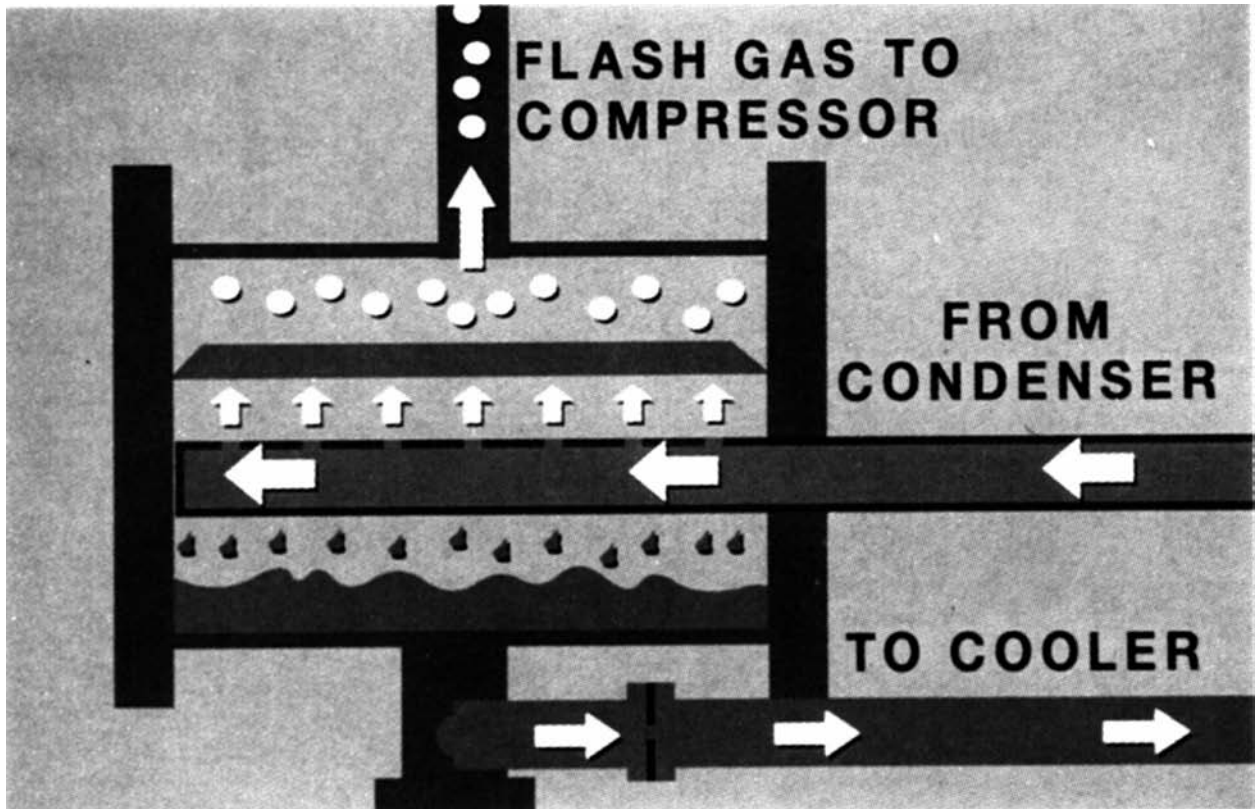

Figure 16 — Economizer Vessel



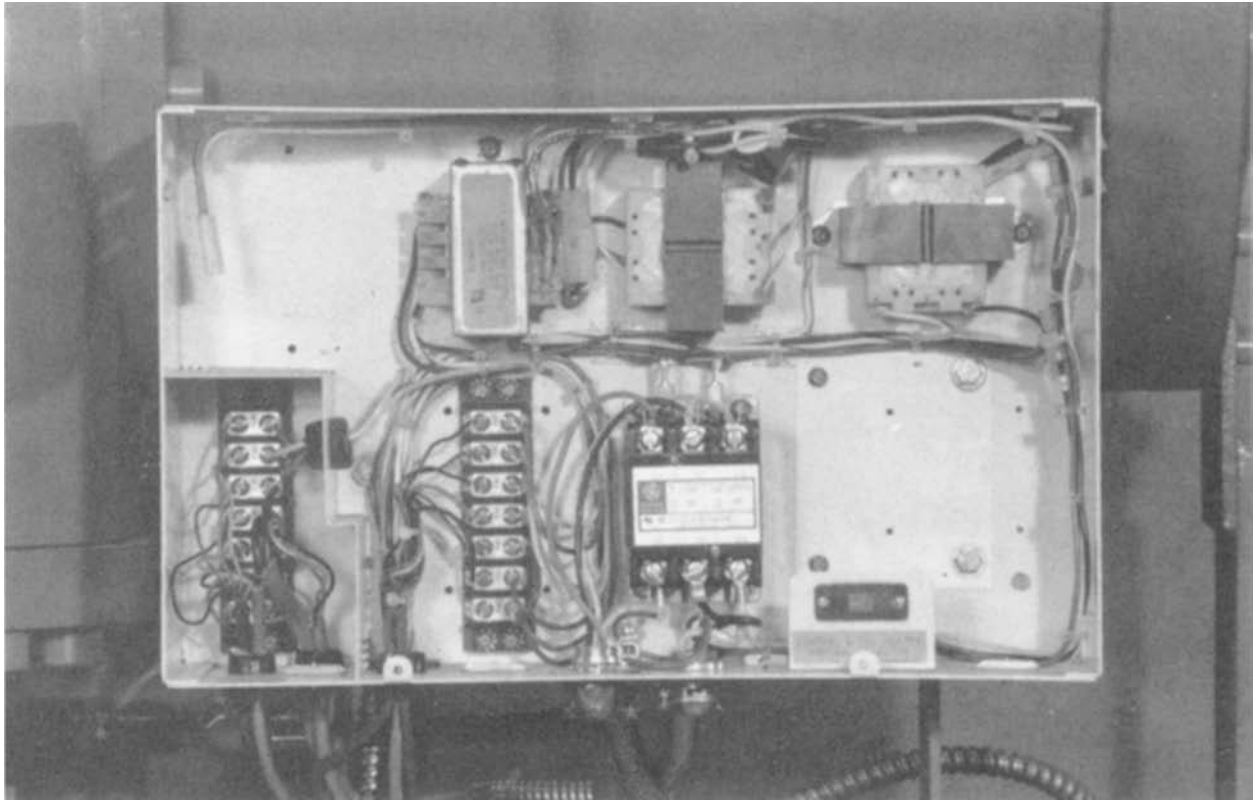

Figure 17 — Power Panel



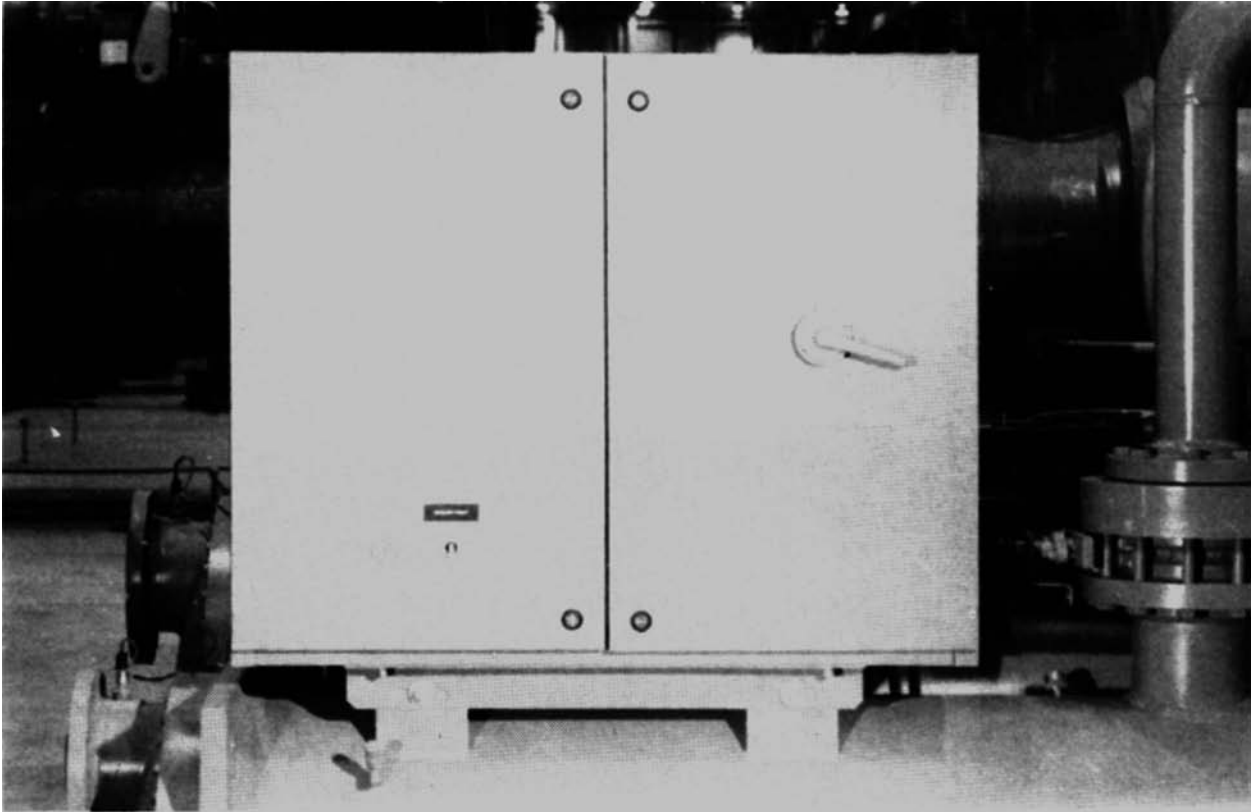

Figure 18 – Factory Mounted Starter

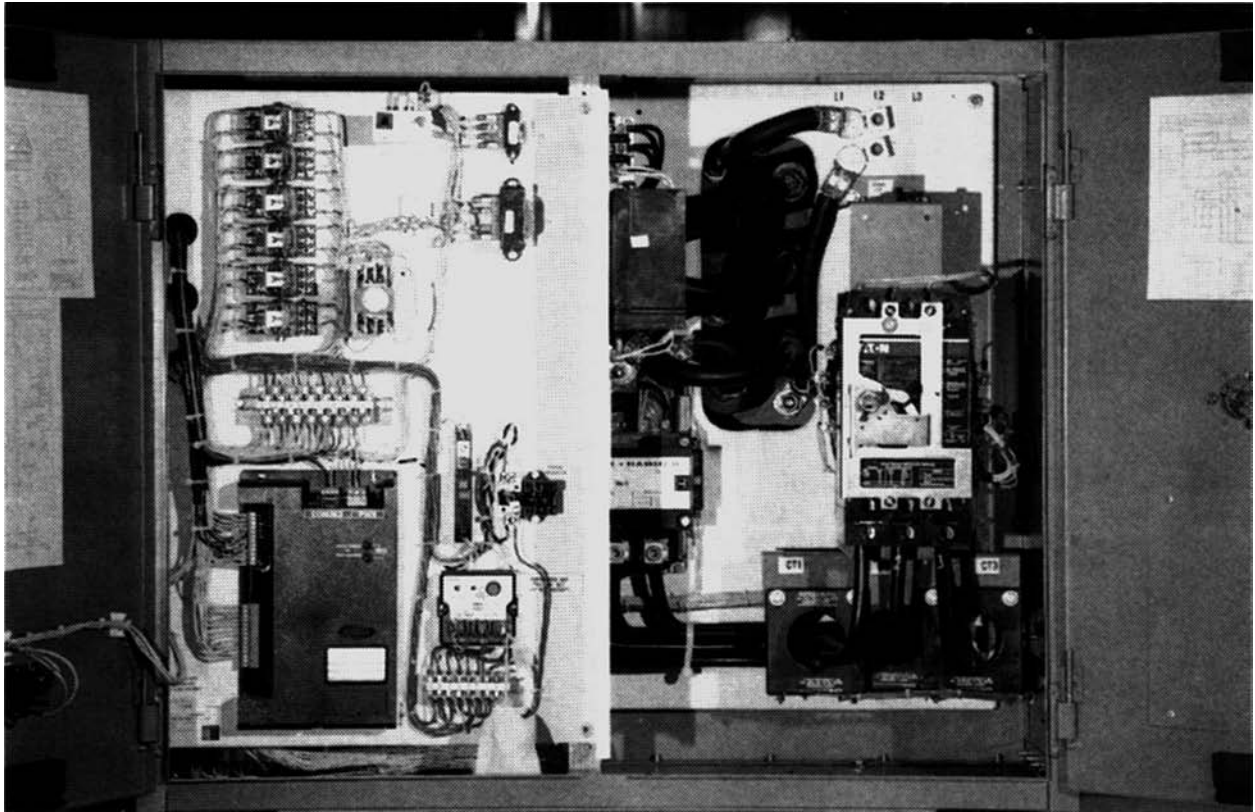

Figure 19 — Electro-Mechanical Starter Panel

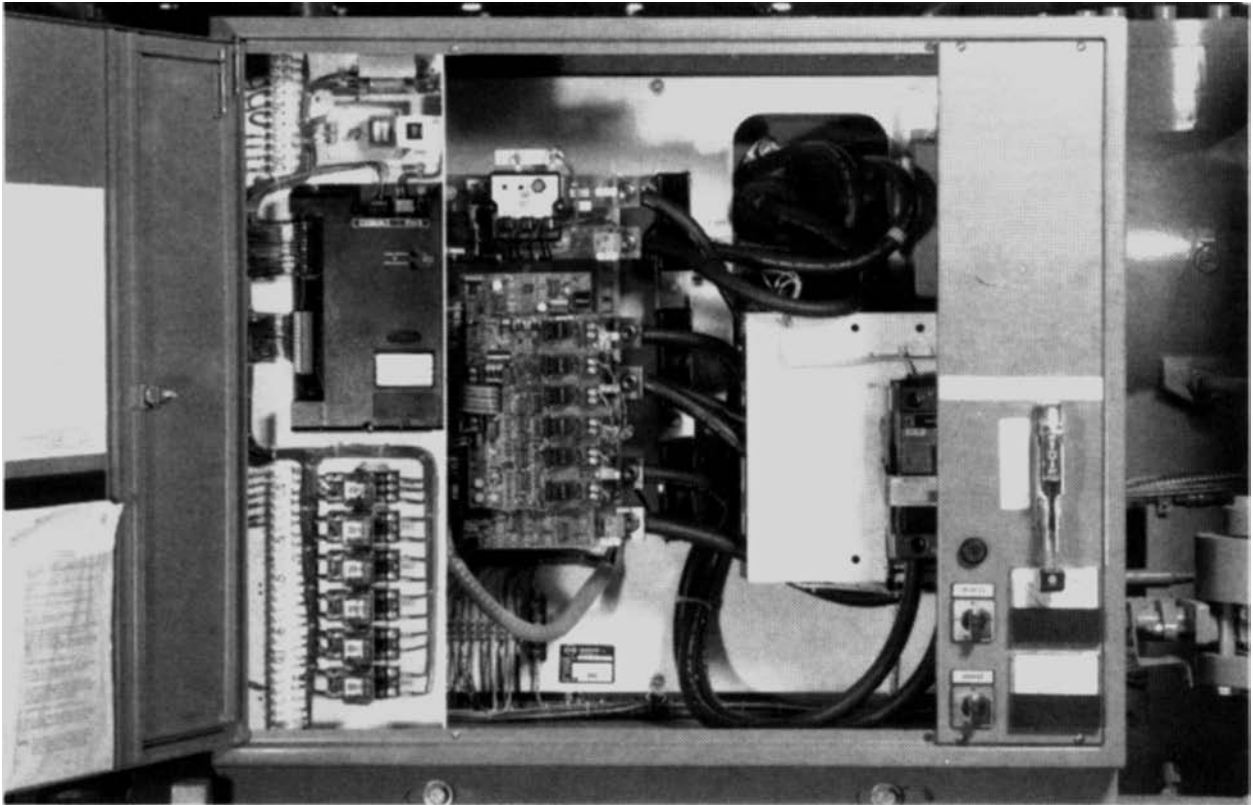

Figure 20 — Solid State Starter

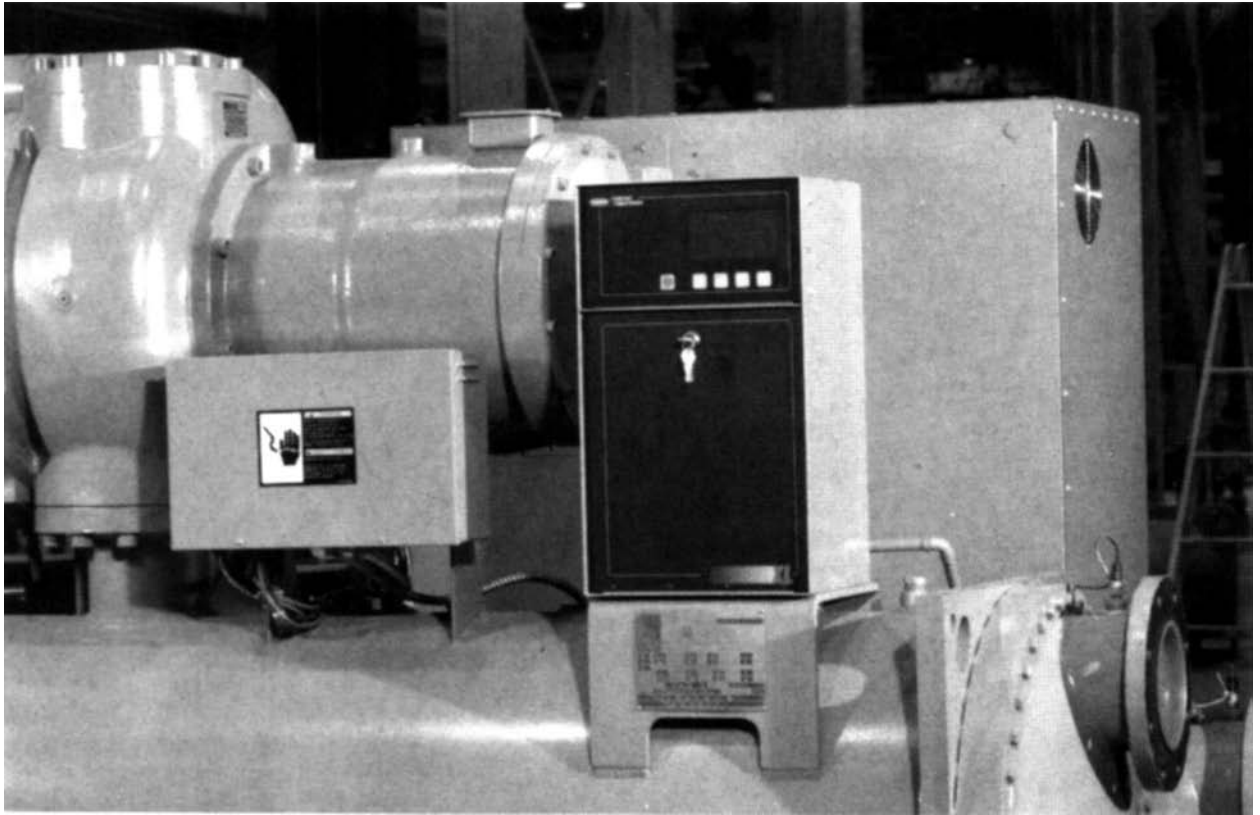

Figure 21 — Control Panel

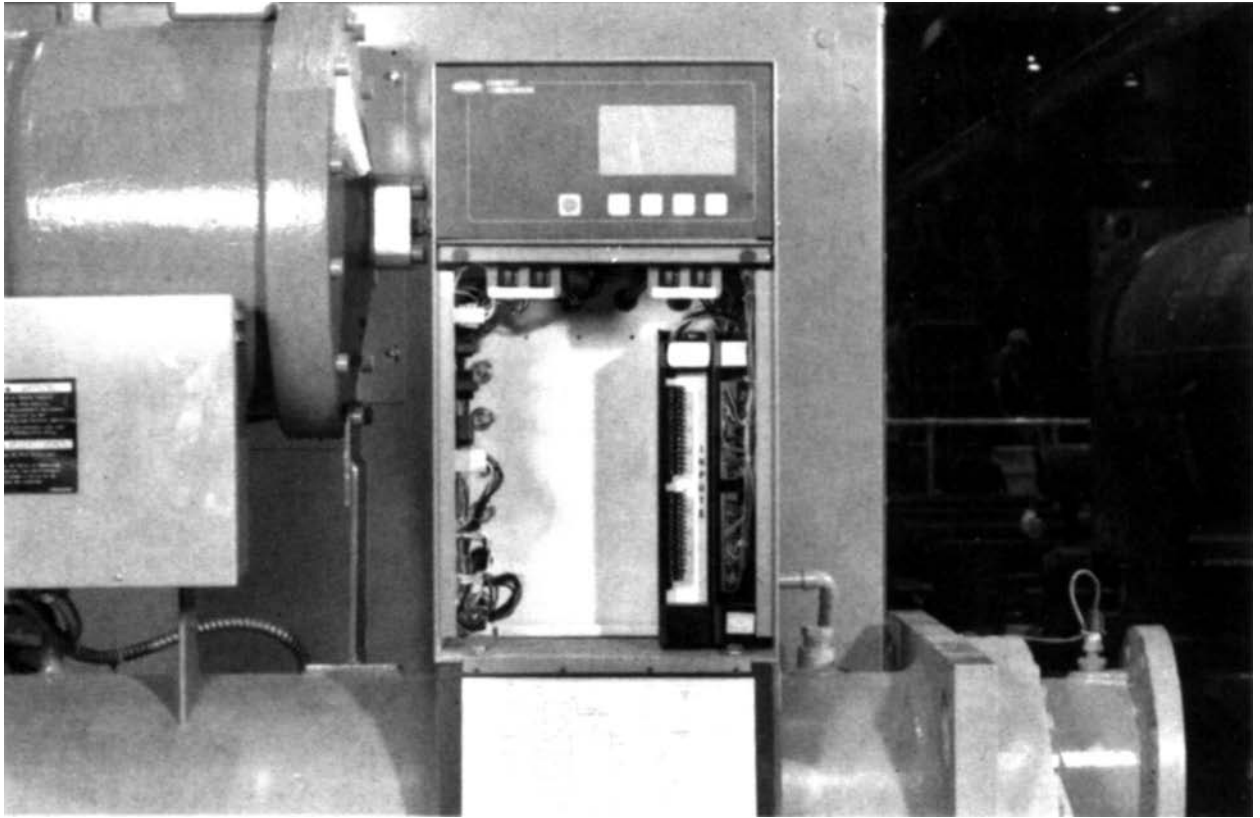

Figure 22 — PIC Control Panel (Front)

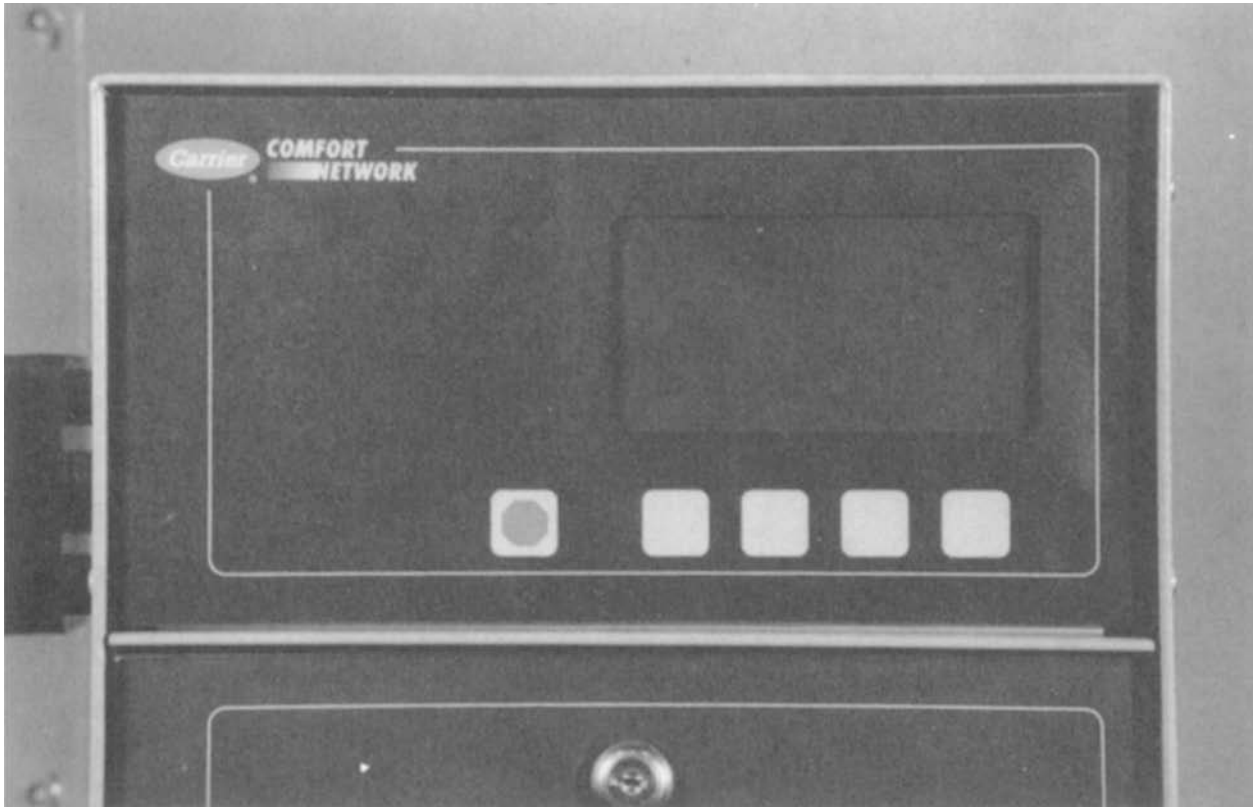

Figure 23 — Local Interface Device (LID)





Figure 24 — Disassembling the Compressor



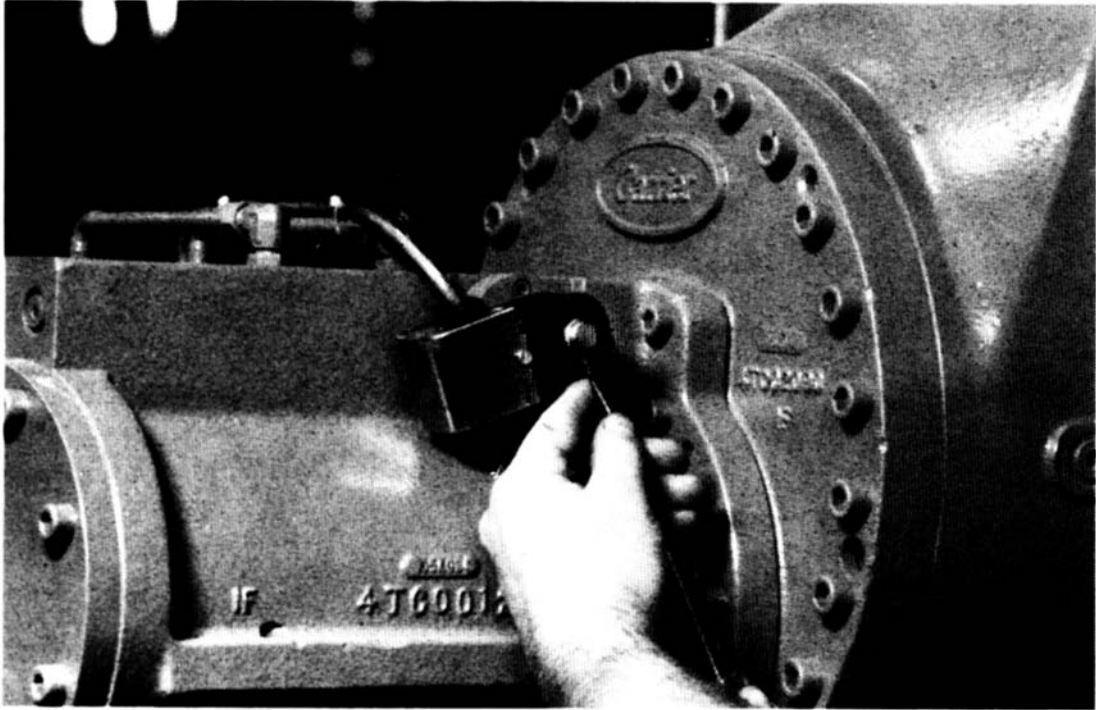

Figure 25 — Removing Solenoids

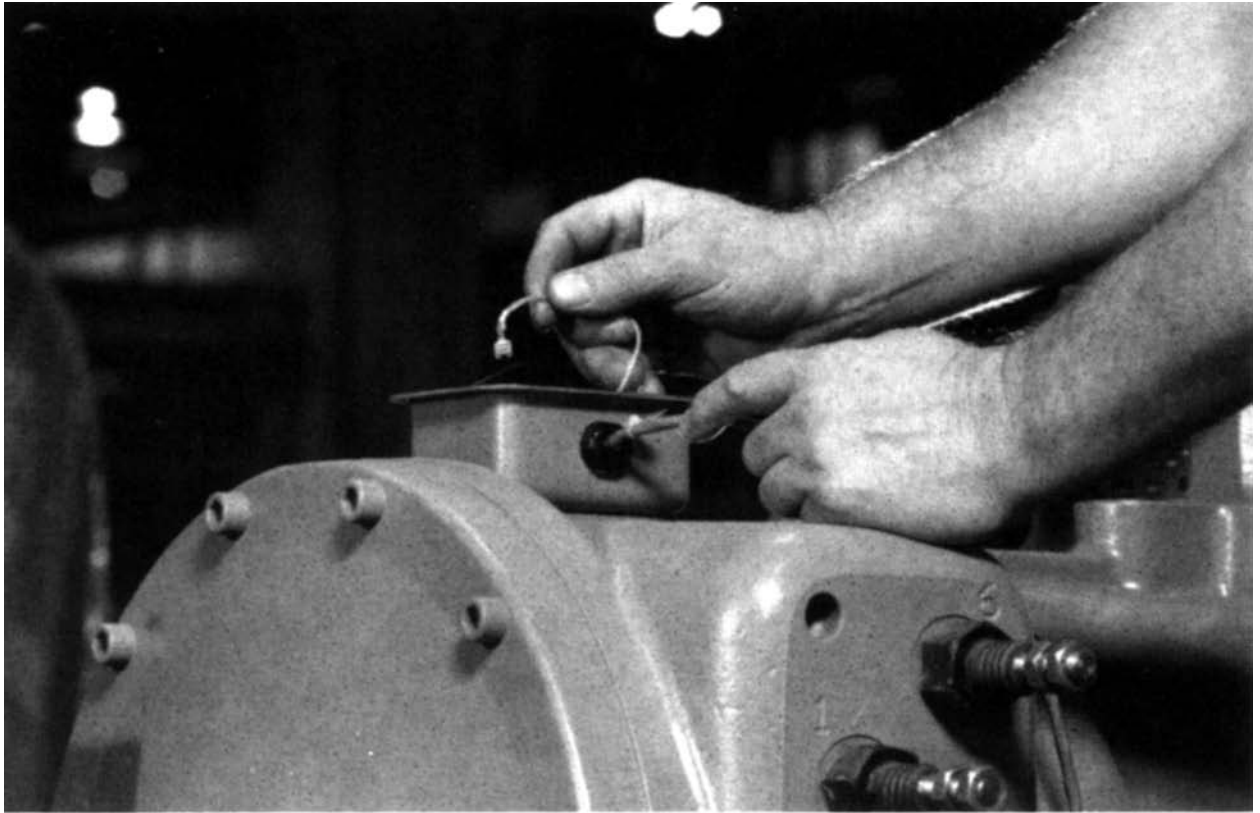

Figure 26 — Motor Terminal Cover

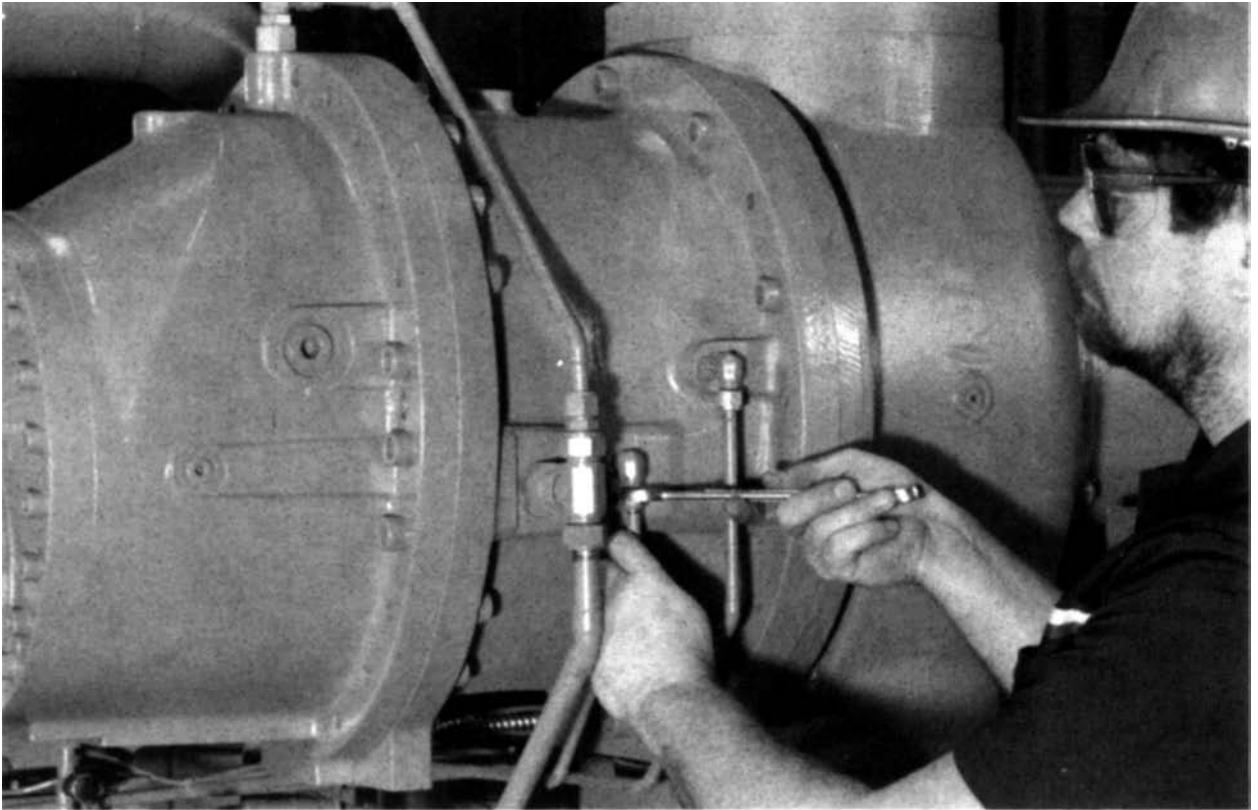

Figure 27 — Oil Supply Line

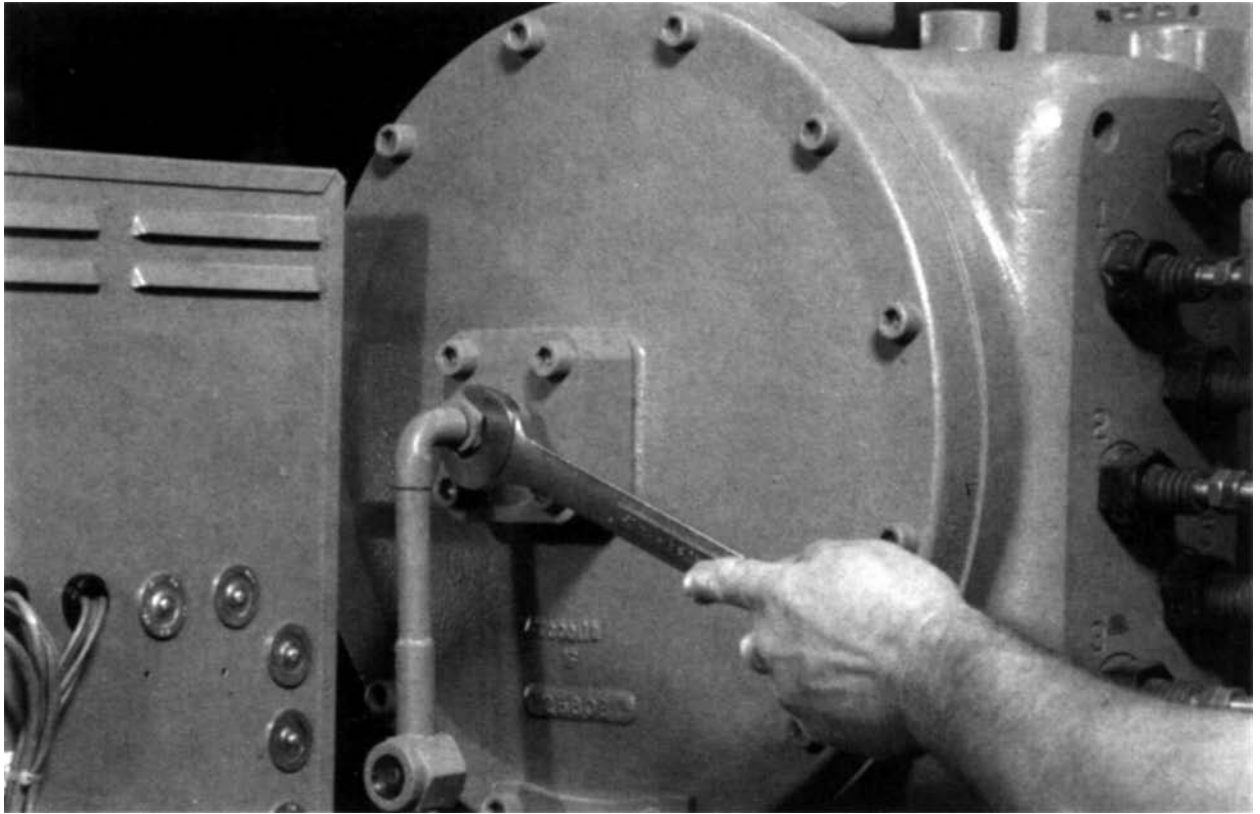

Figure 28 — Motor Cooling Line

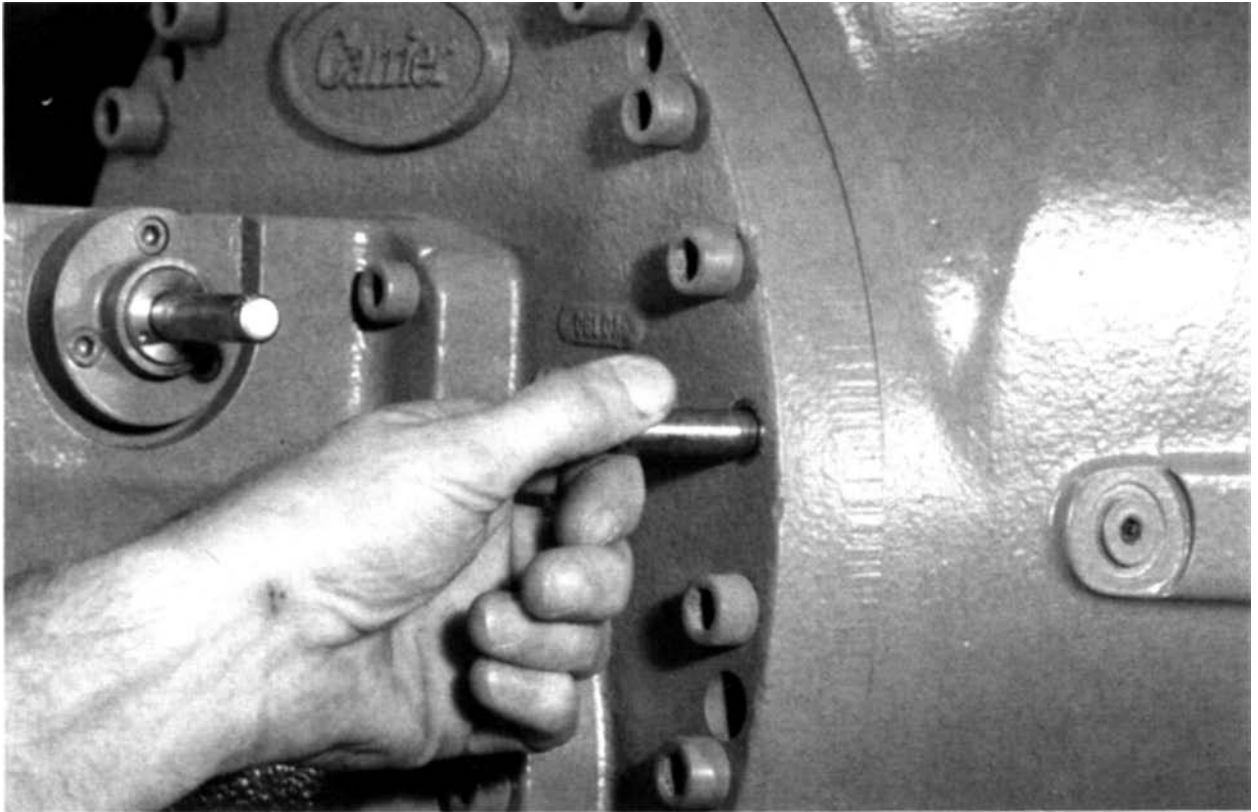

Figure 29 — Compressor Disassembly

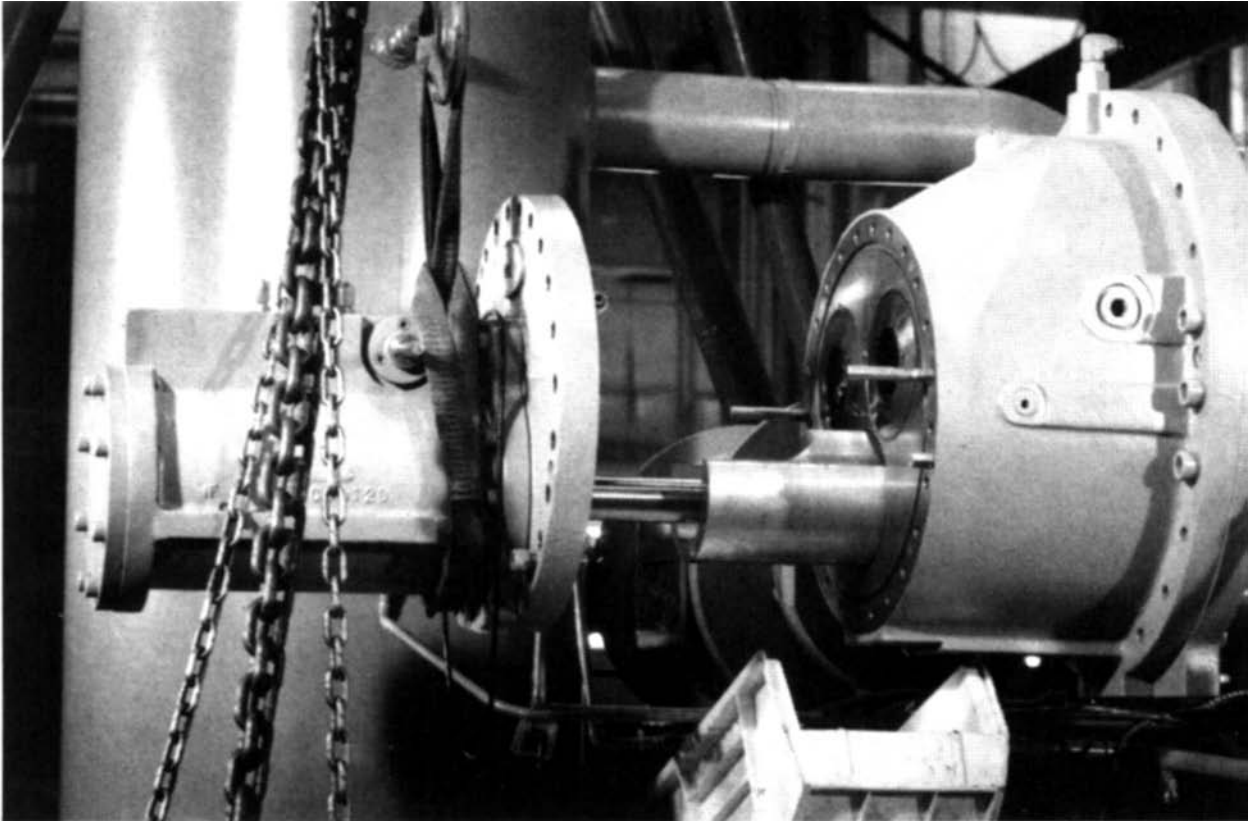

Figure 30 — Slide Valve Assembly

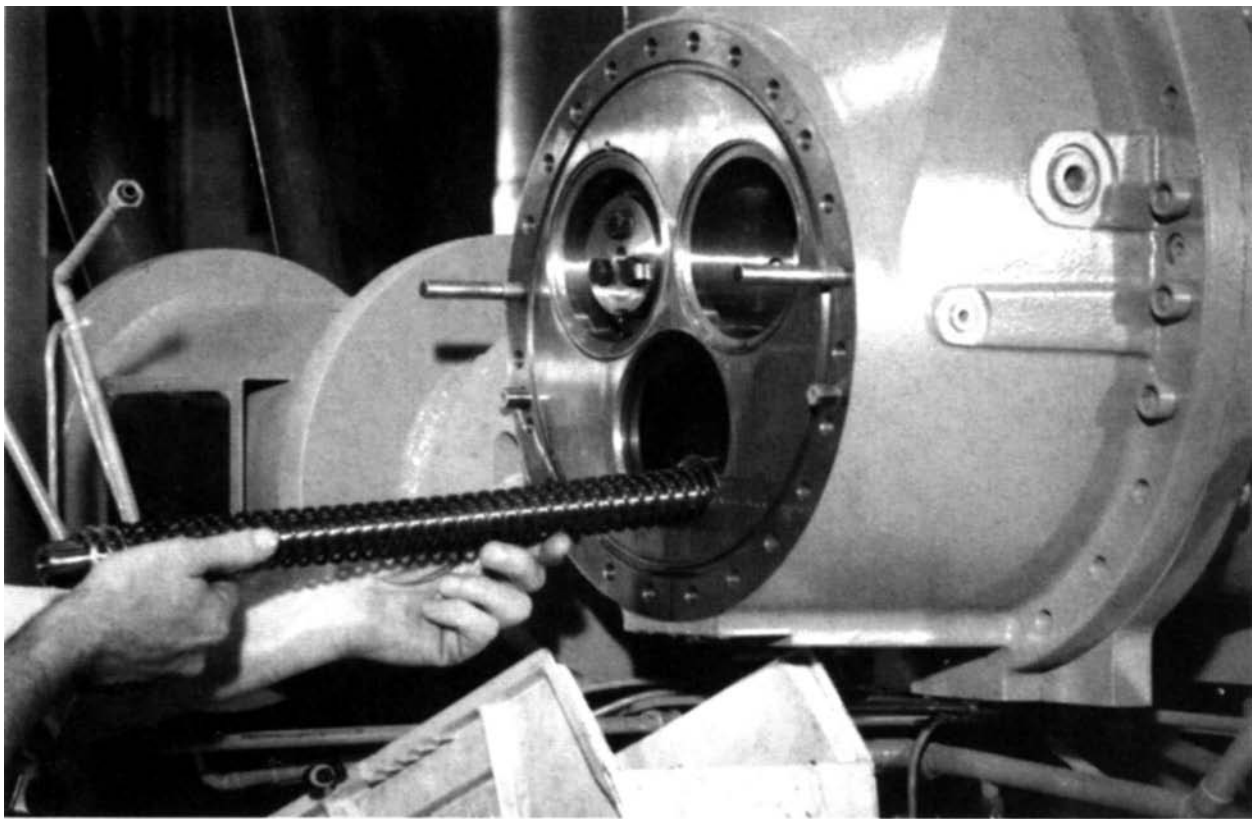

Figure 31 — Spring Retainer Assembly Removal

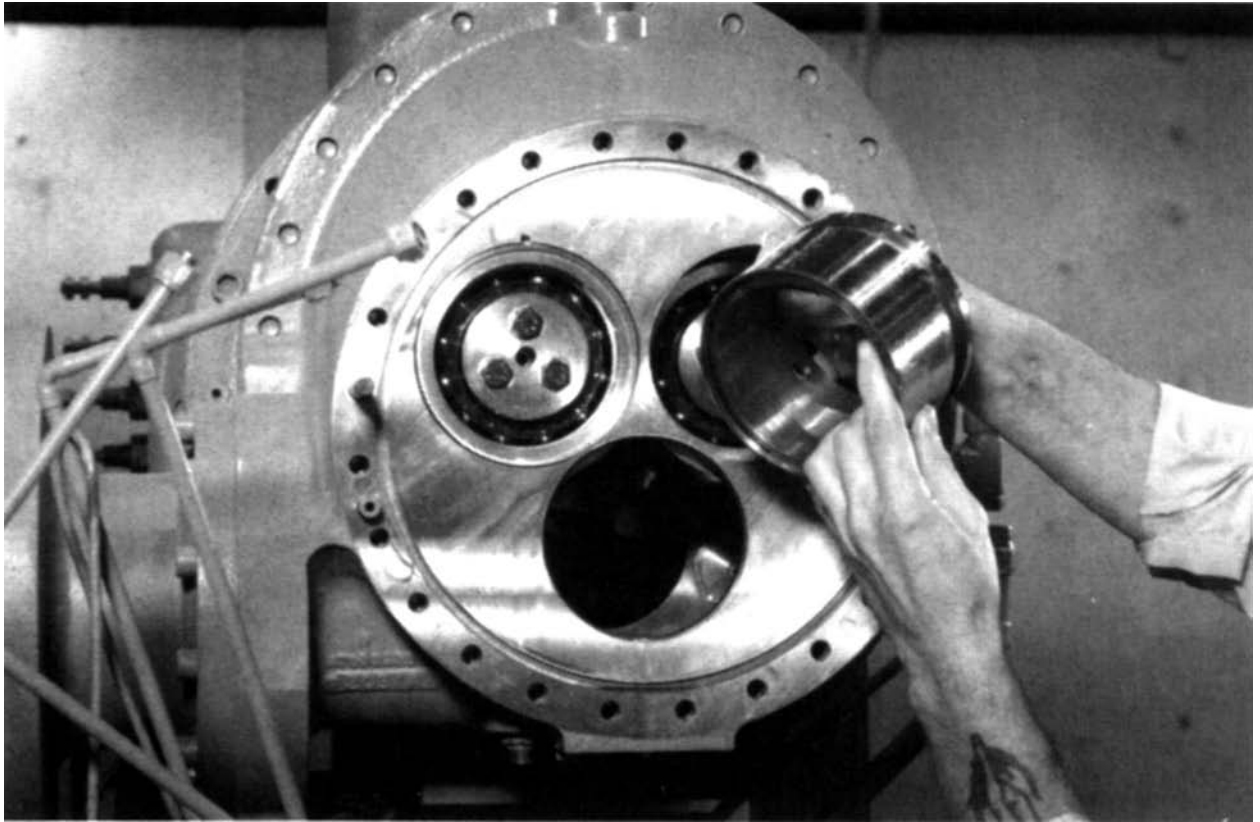

Figure 32 — Bearing Spacers

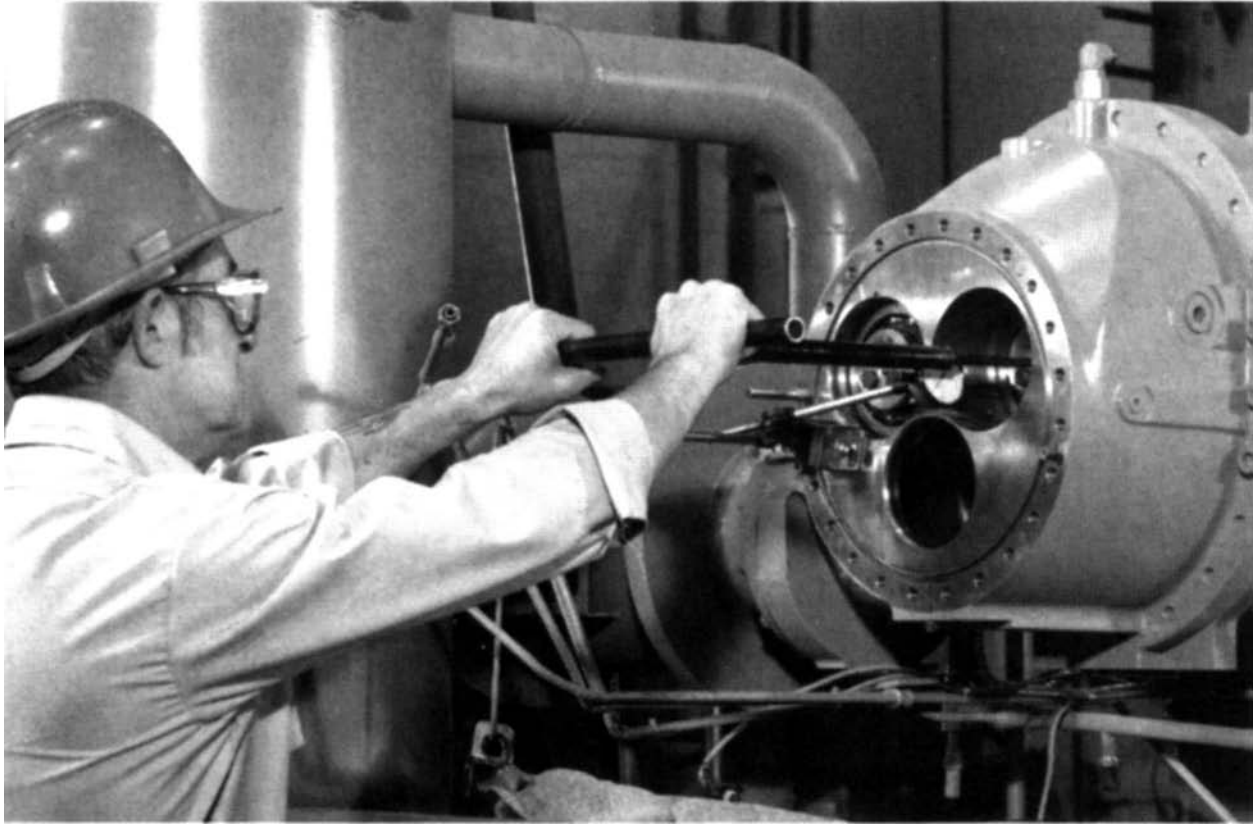

Figure 33 — Measuring Thrust or Rotor End Clearance

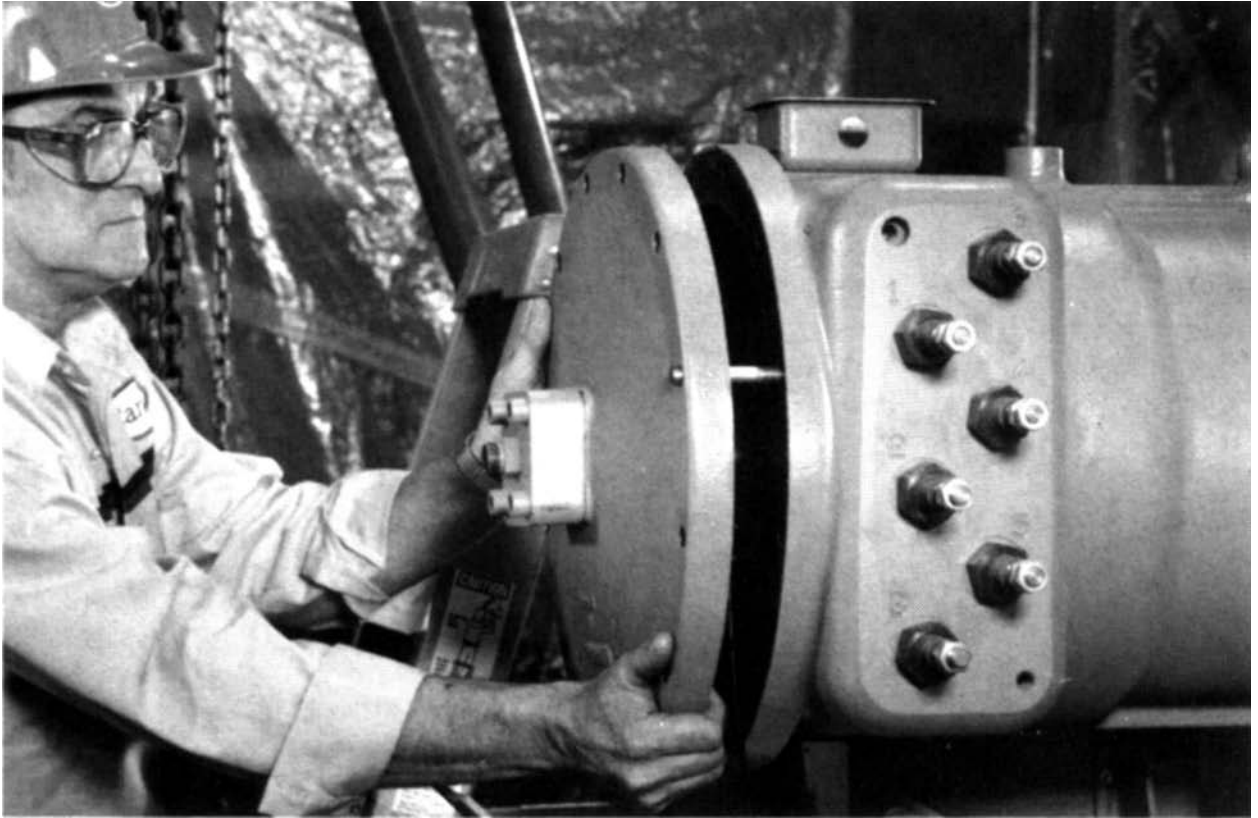

Figure 34 — Motor End Cover Removal

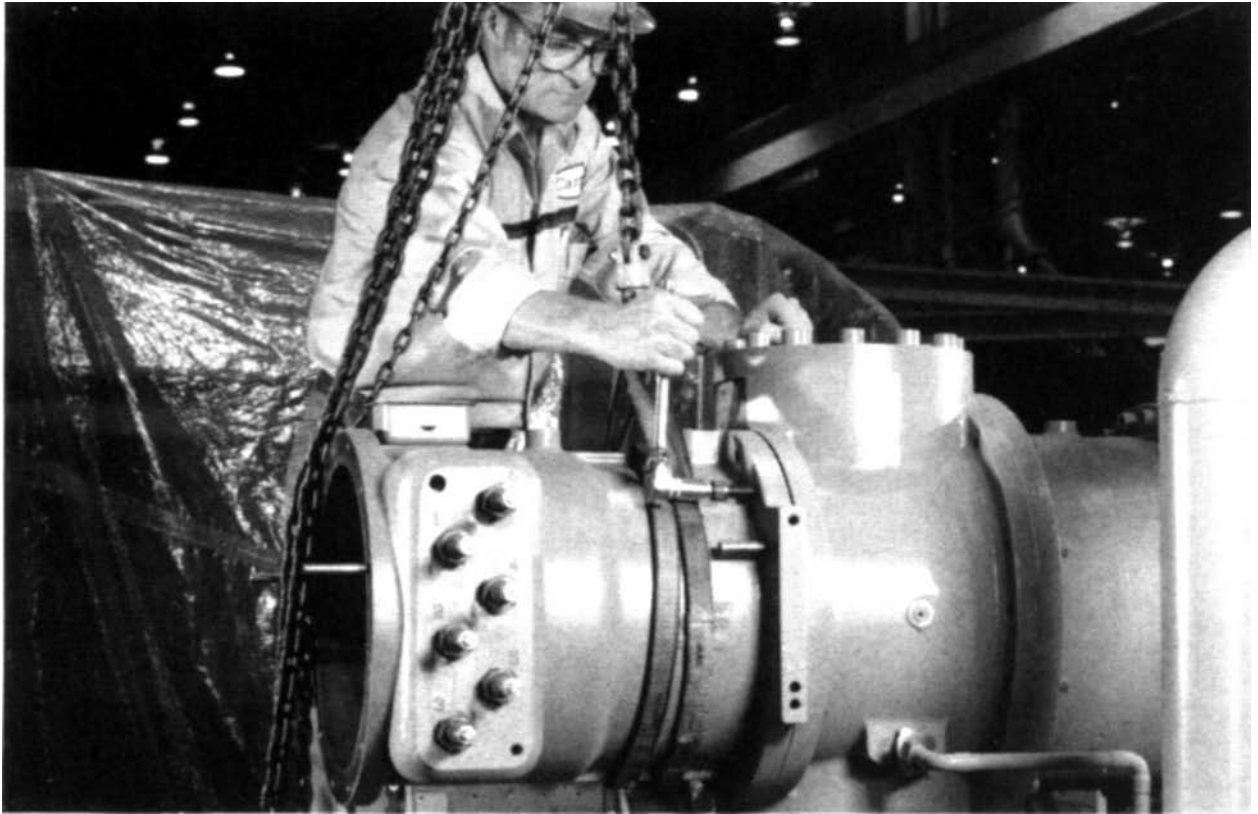

Figure 35 — Motor Casing Removal

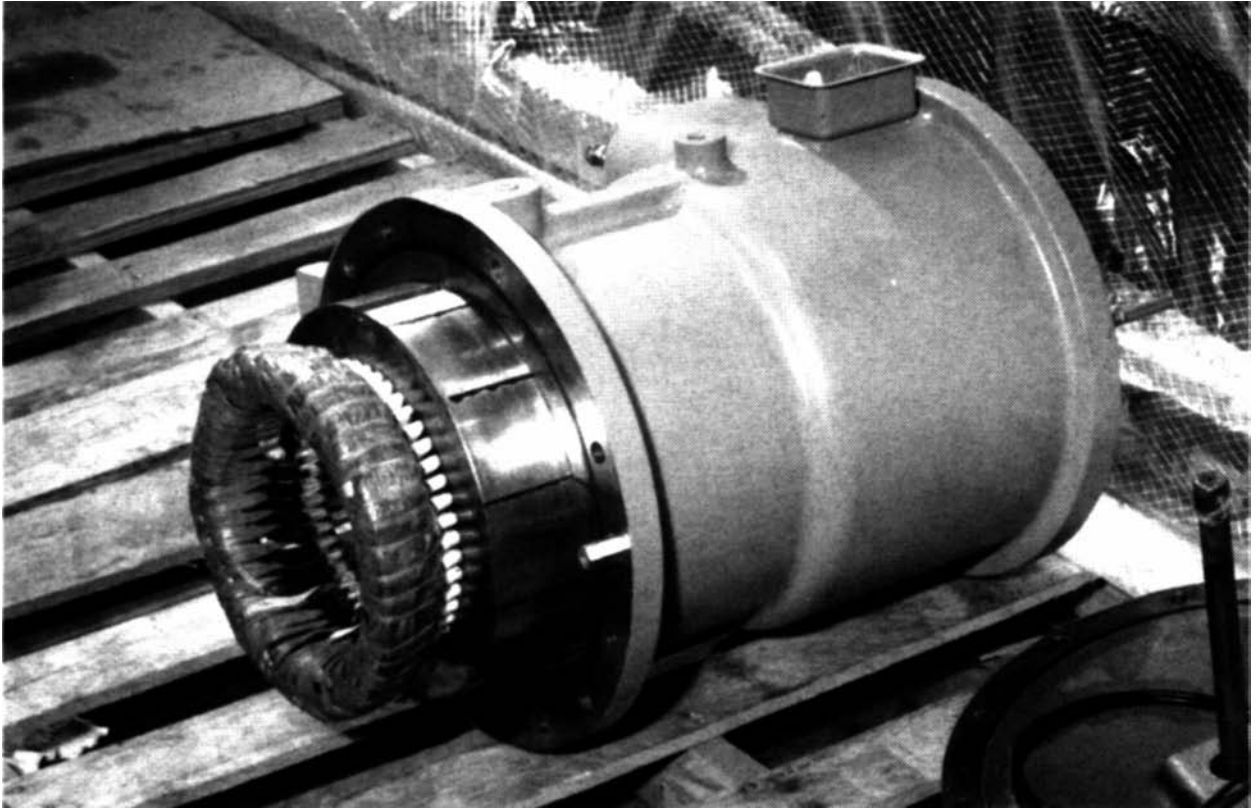

Figure 36 — Motor Casing



Figure 37 — Rotor



Figure 38 — Rigging the Rotor



Figure 39 — Outlet Casing

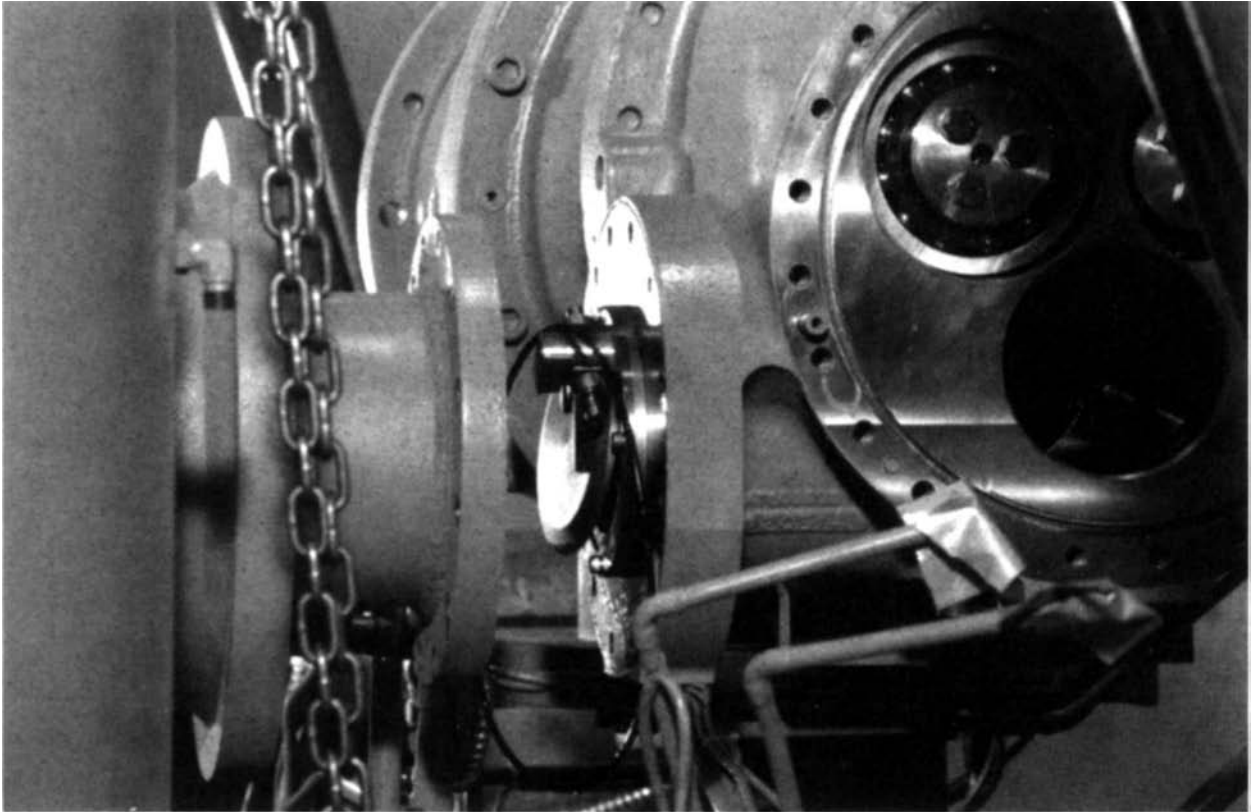

Figure 40 — Check Valve Flapper

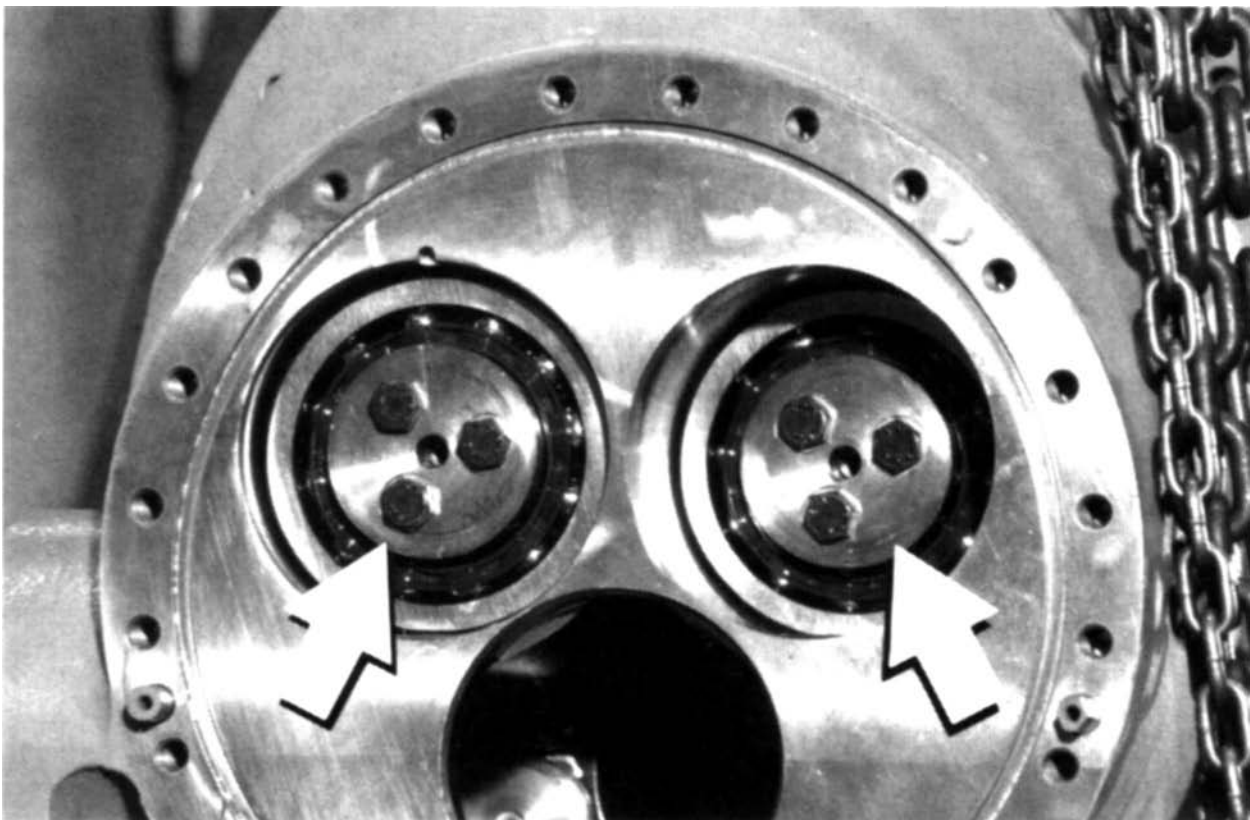

Figure 41 — Guide Bolt Locations

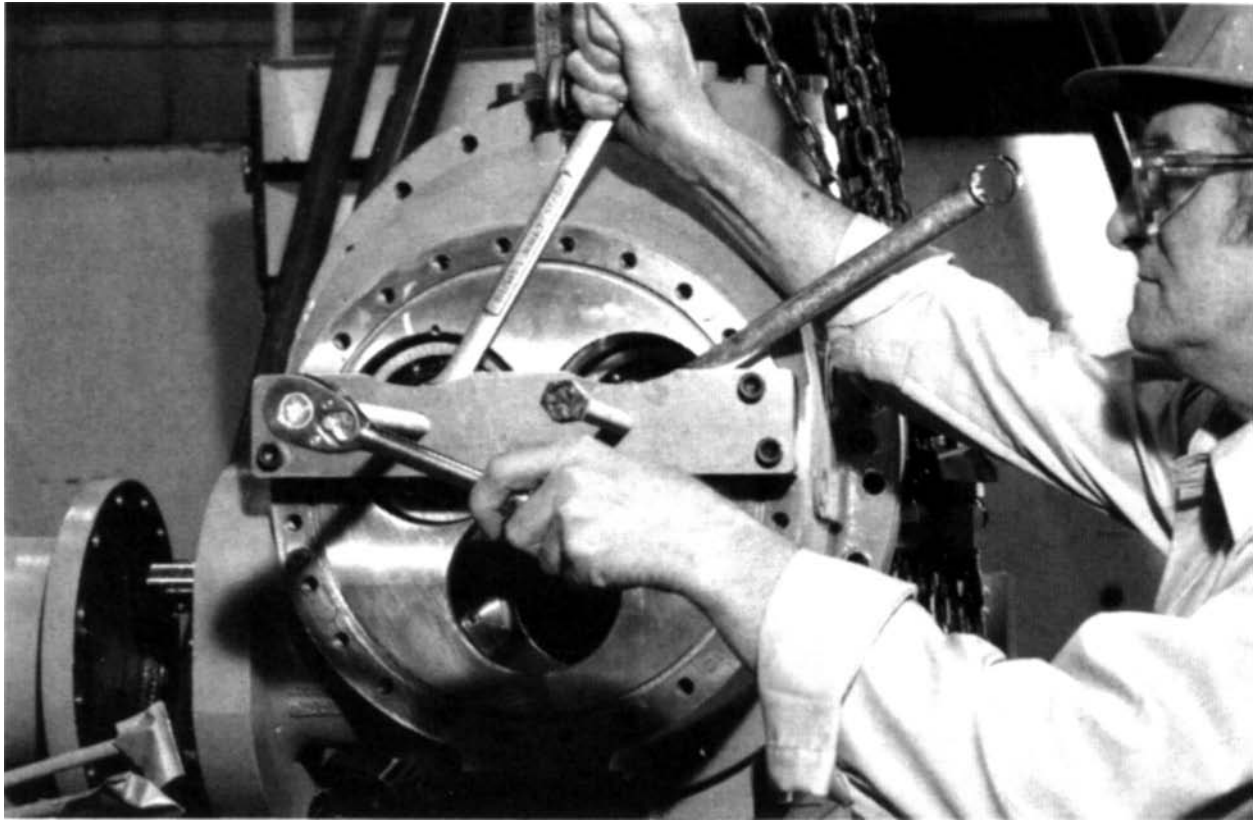

Figure 42 — Rotor Bearing Removal Tool

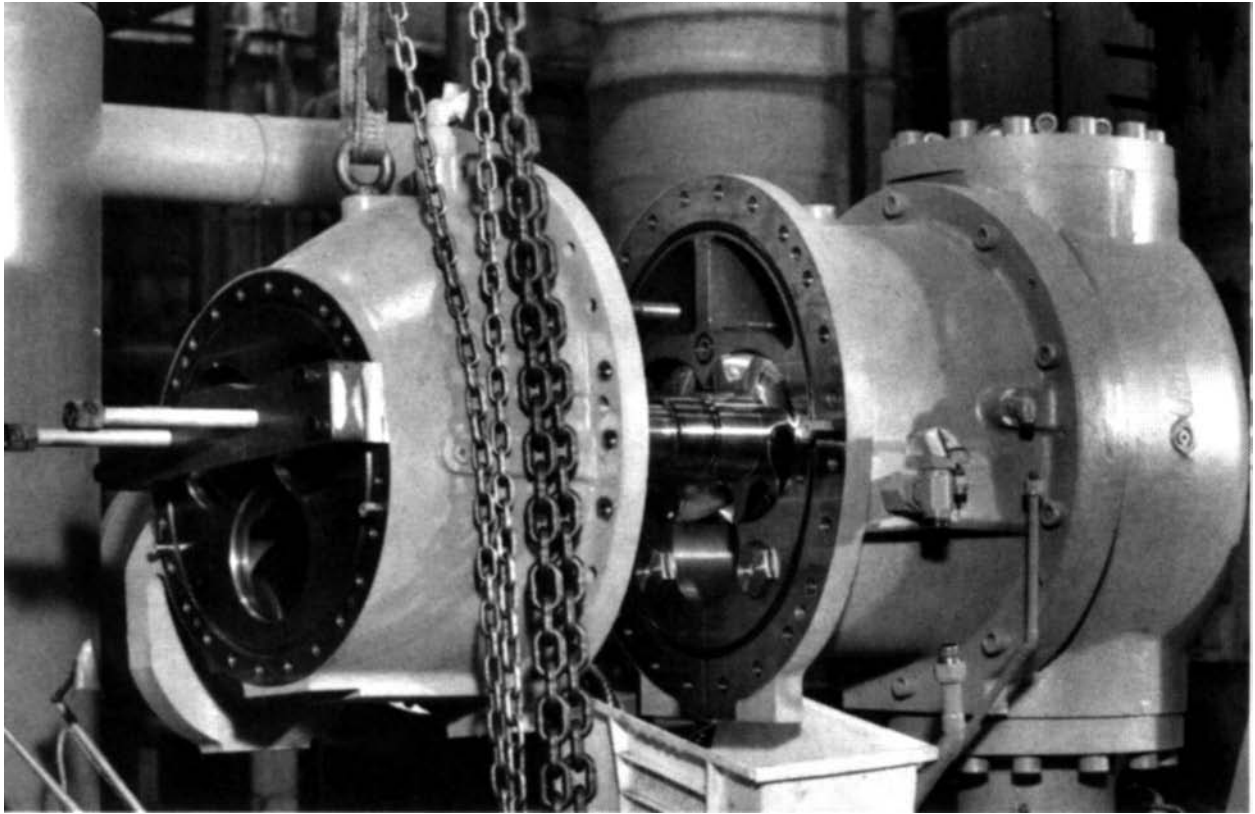

Figure 43 — Outlet Casing/Rotor Casing

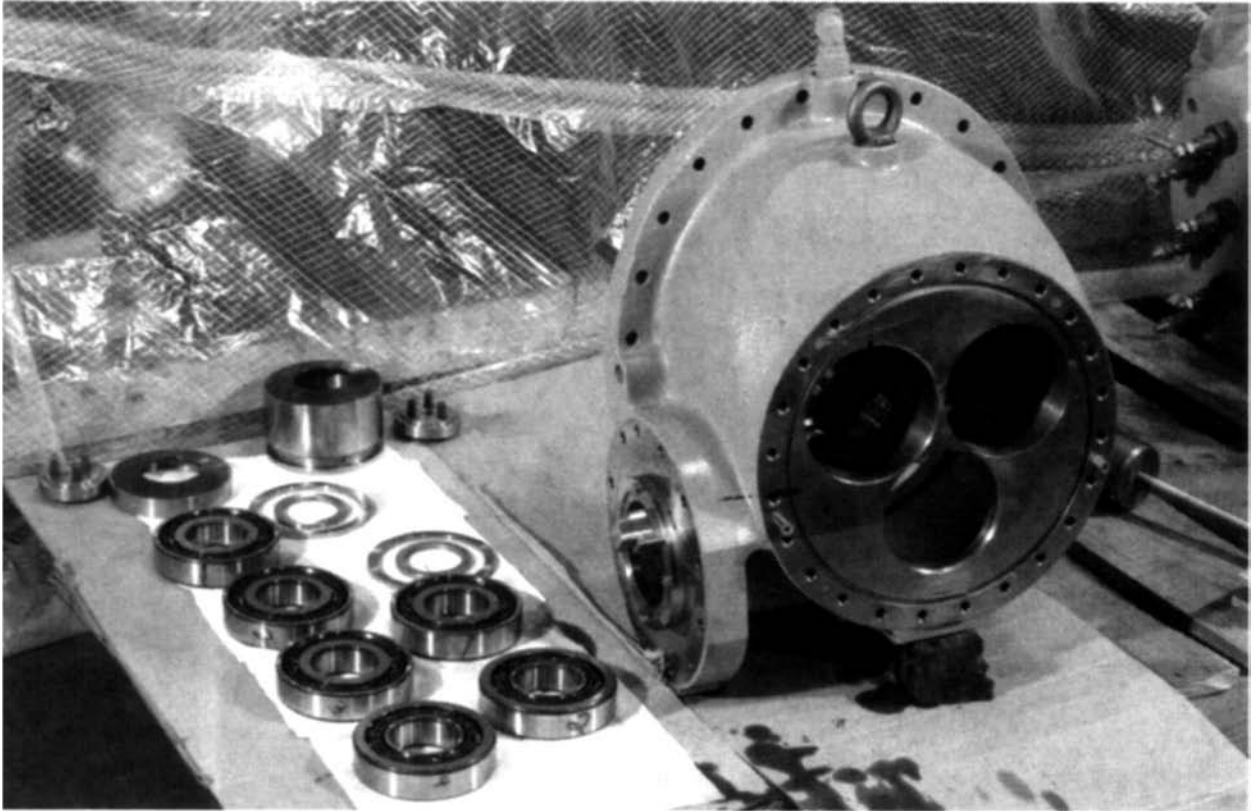

Figure 44 — Bearings

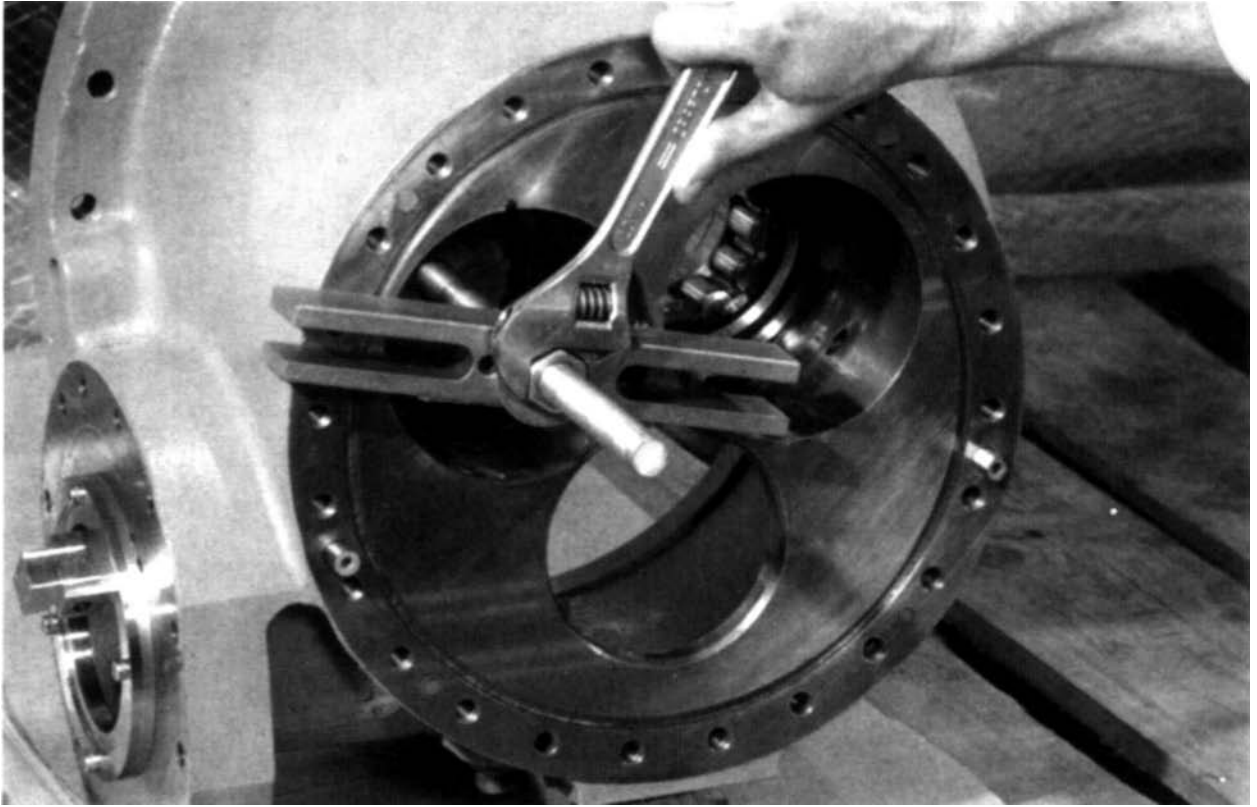

Figure 45 — Roller Bearing Puller

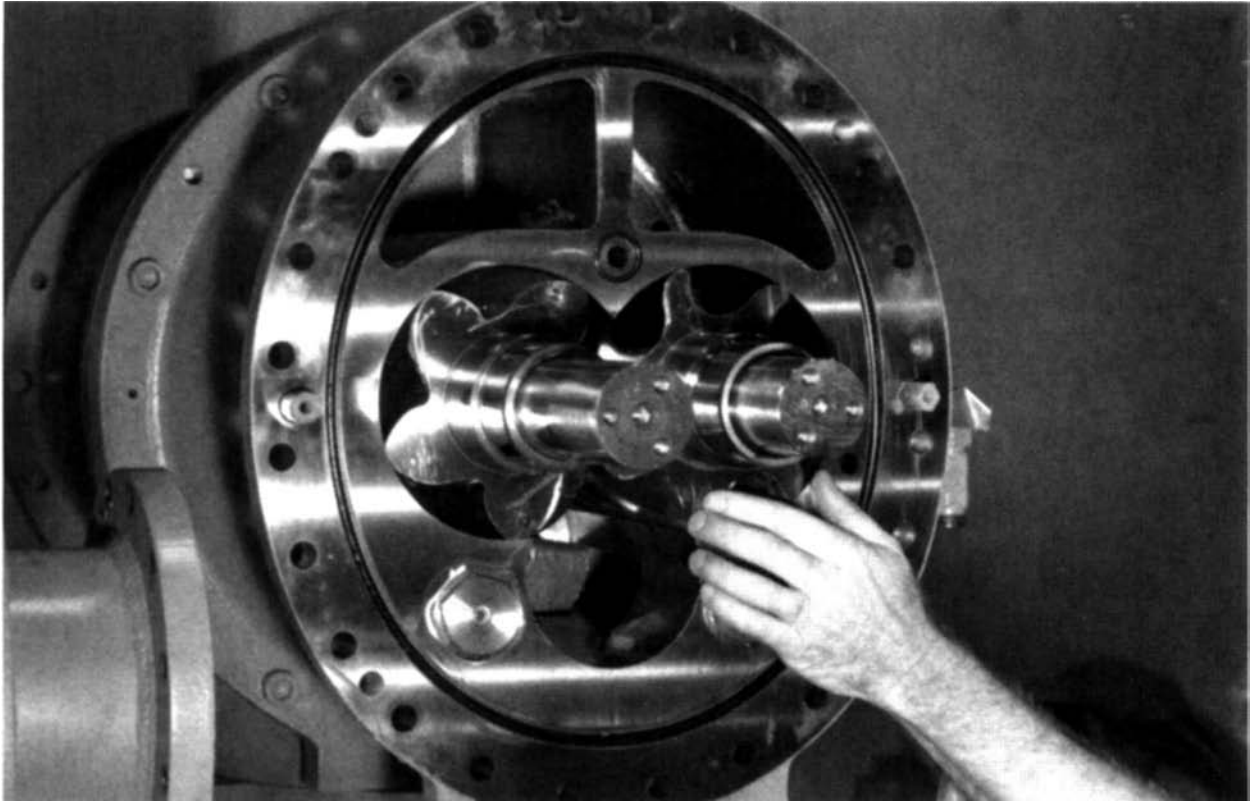

Figure 46 — Rotors

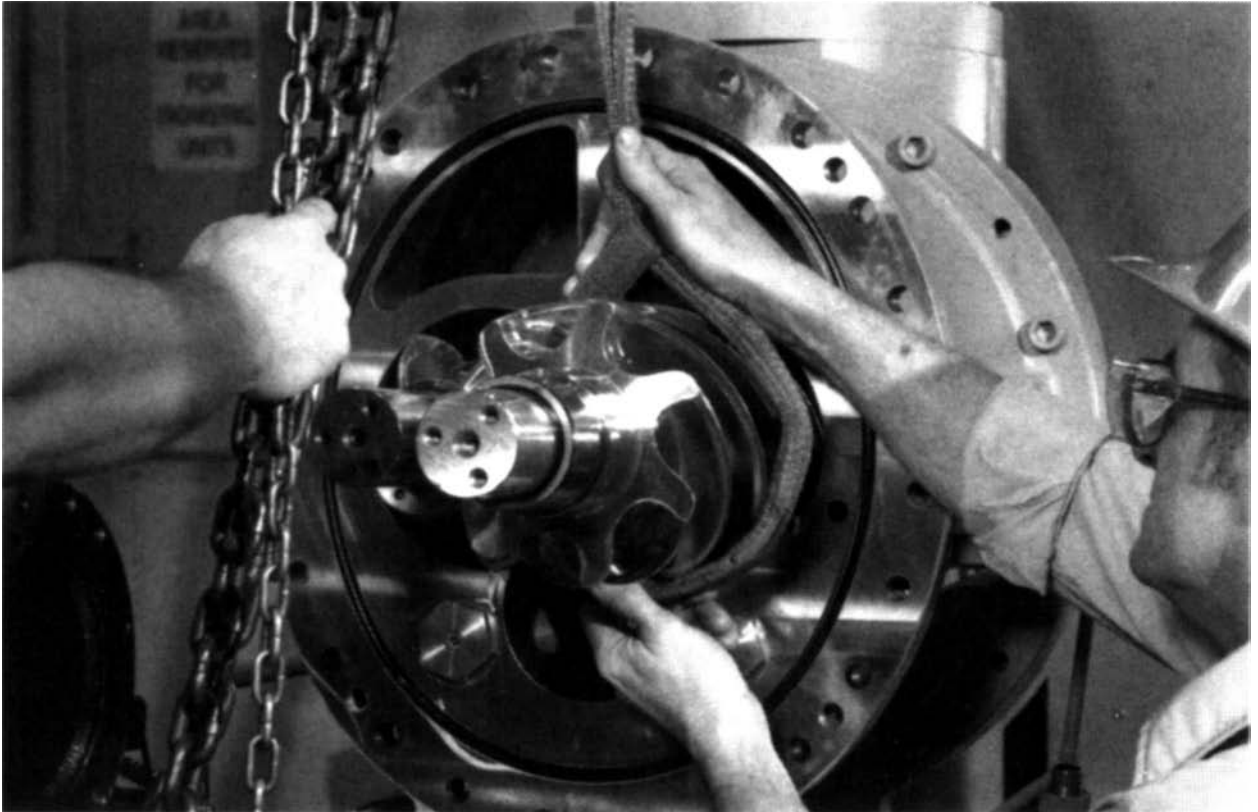

Figure 47 — Removing Female Rotor



Figure 48 — Removing Male Rotor



Figure 49 — Supporting Removed Rotors



Figure 50 — Rotor Inspection

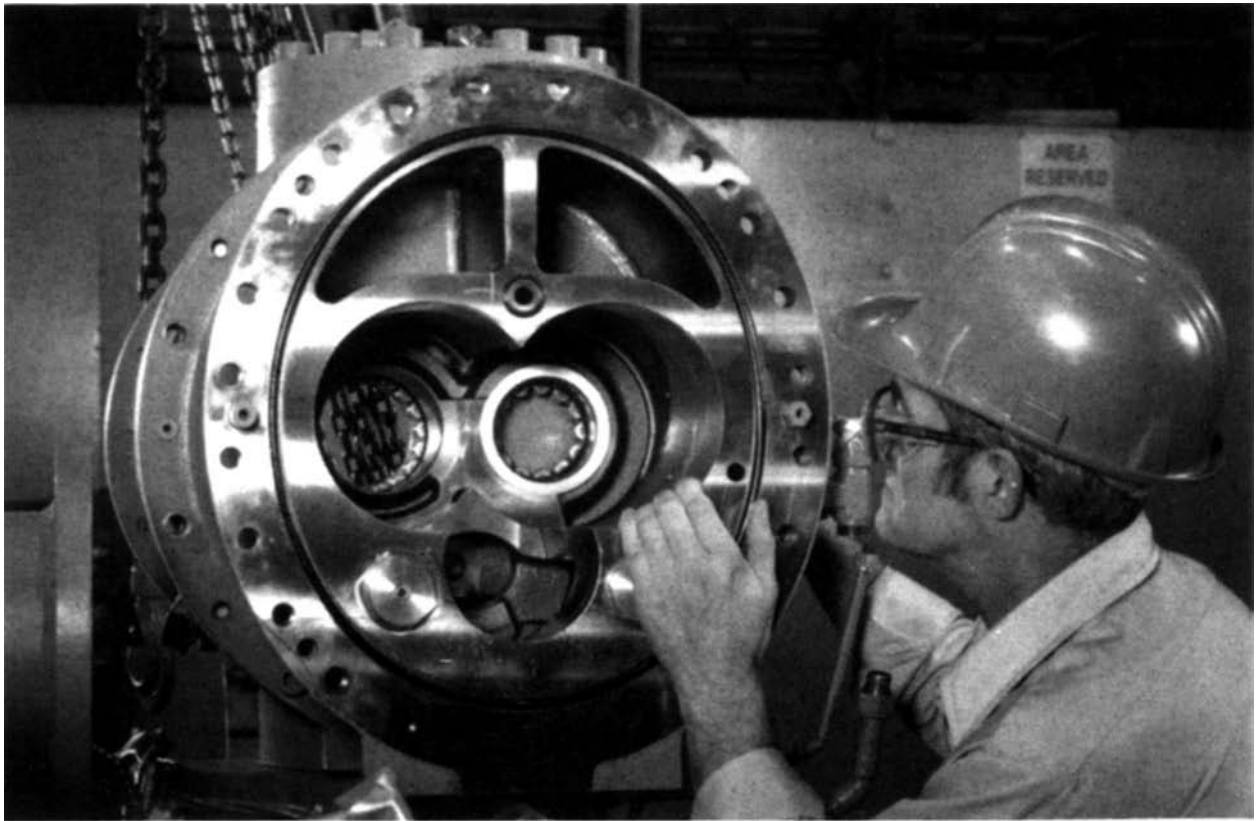

Figure 51 — Rotor Bores

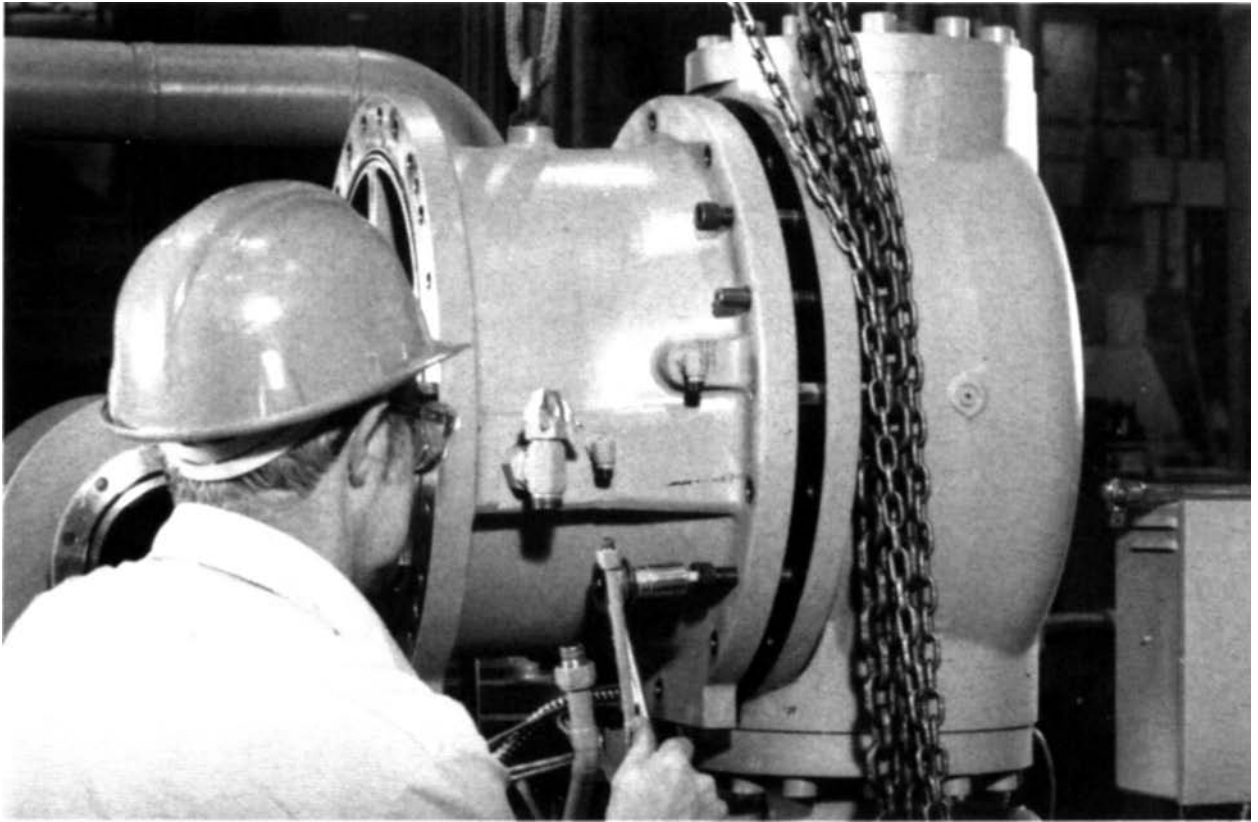

Figure 52 — Rotor Casing Removal

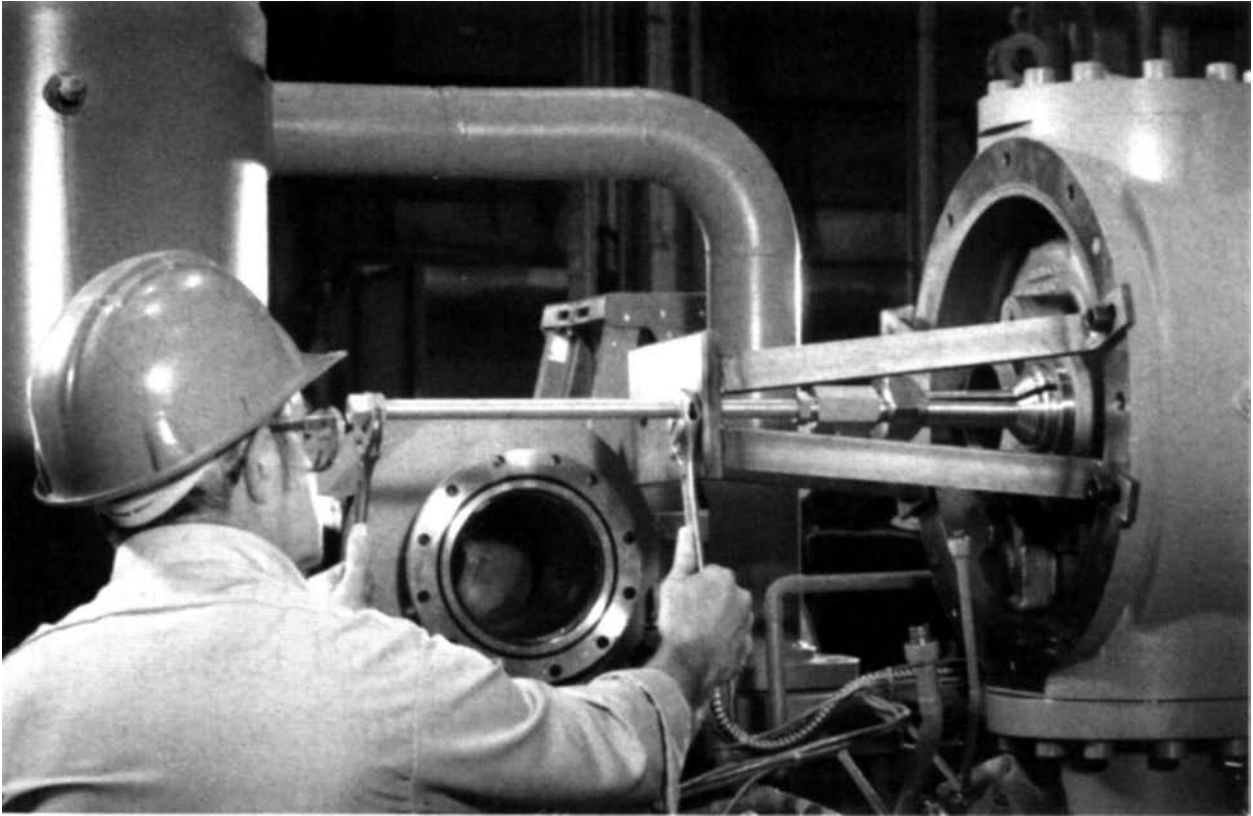

Figure 53 — Removing Female Inlet Case Bearing Sleeve

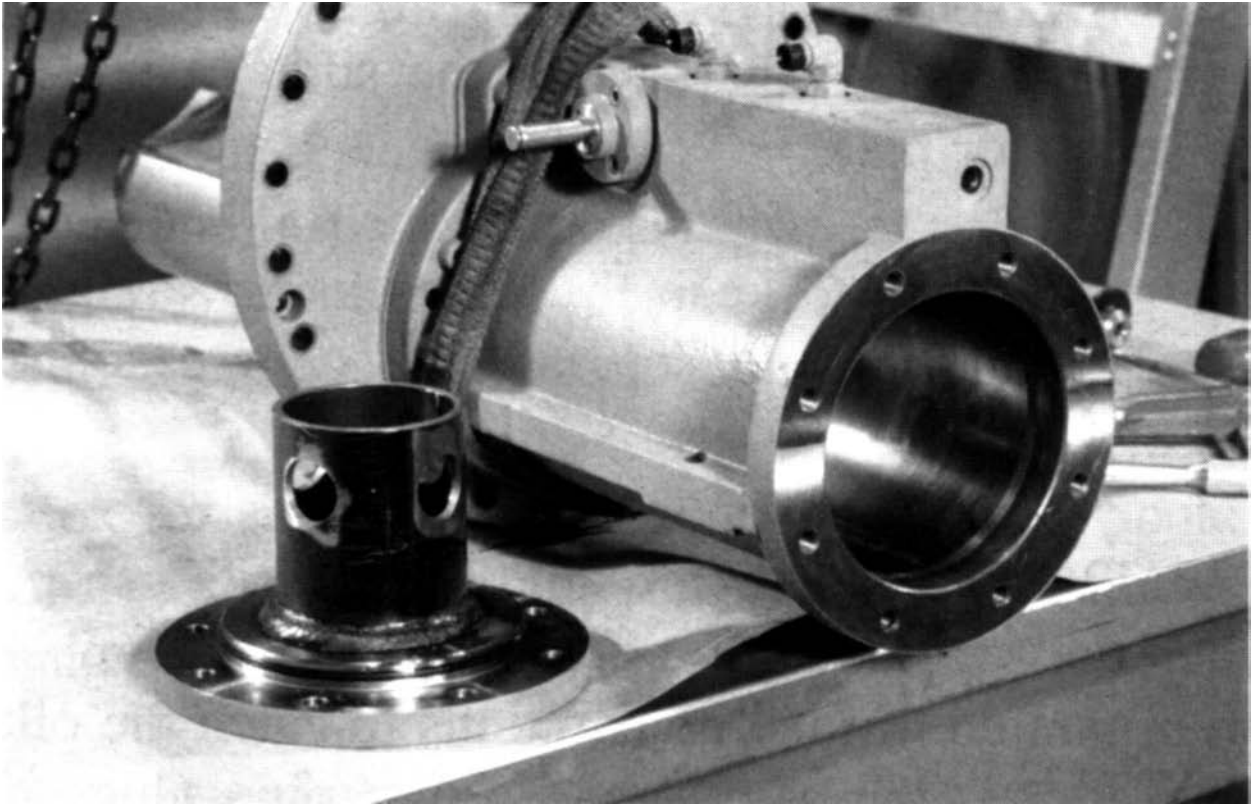

Figure 54 — Slide Valve Disassembly

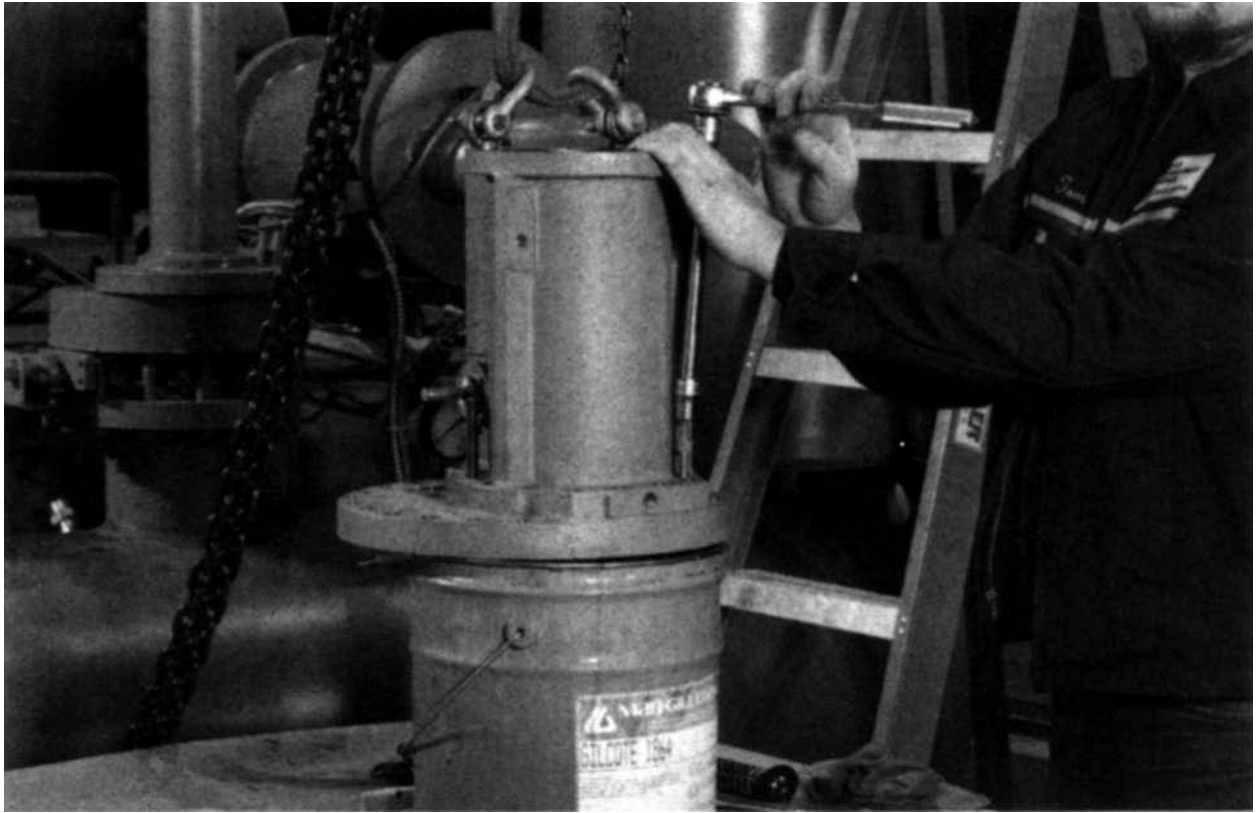

Figure 55 — Slide Valve Rigging



Figure 56 — Slide Casing and Piston

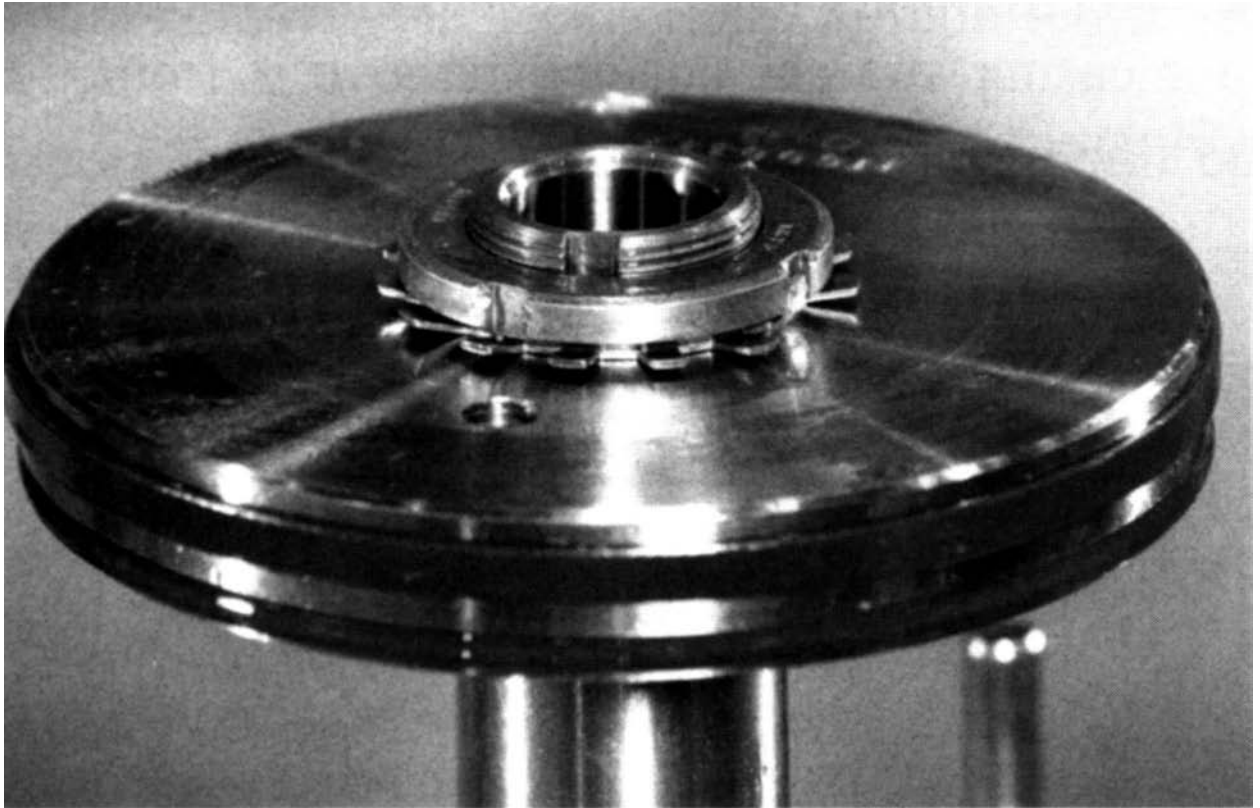

Figure 57 — Capacity Rod

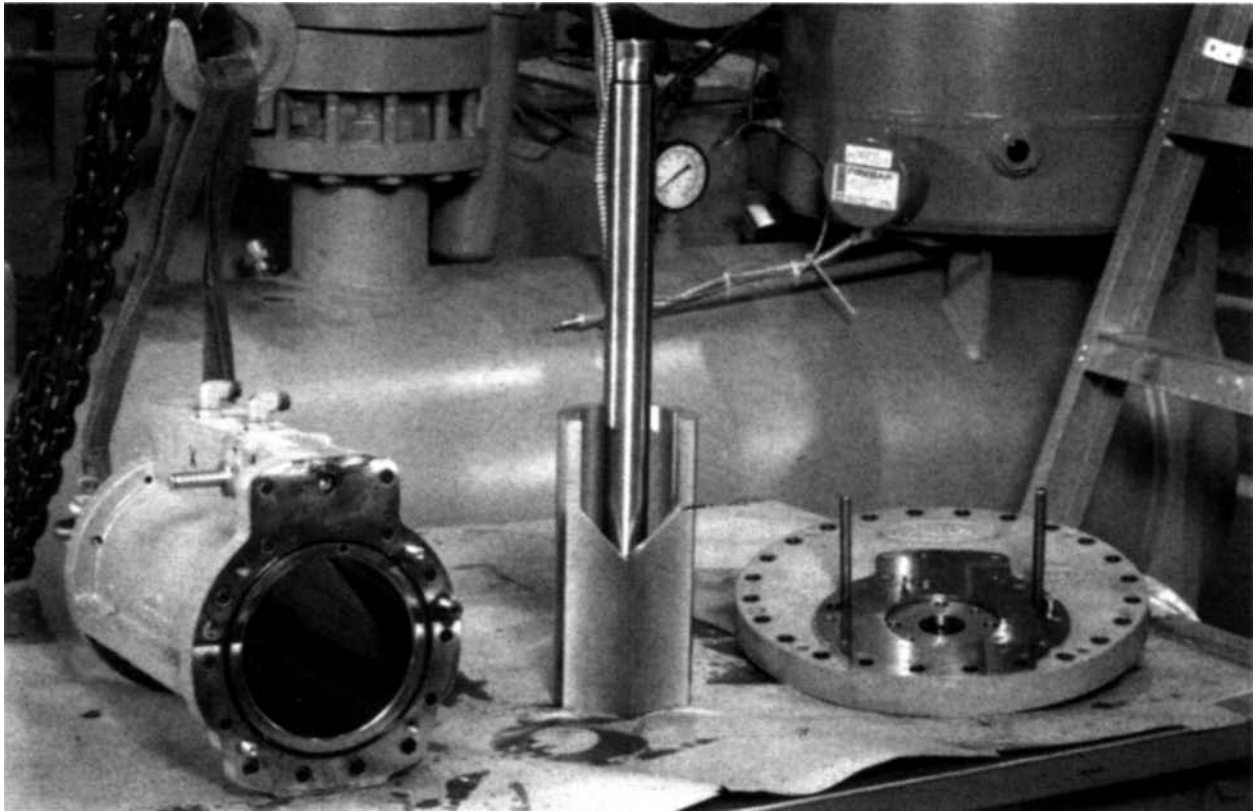

Figure 58 — Separator Plate

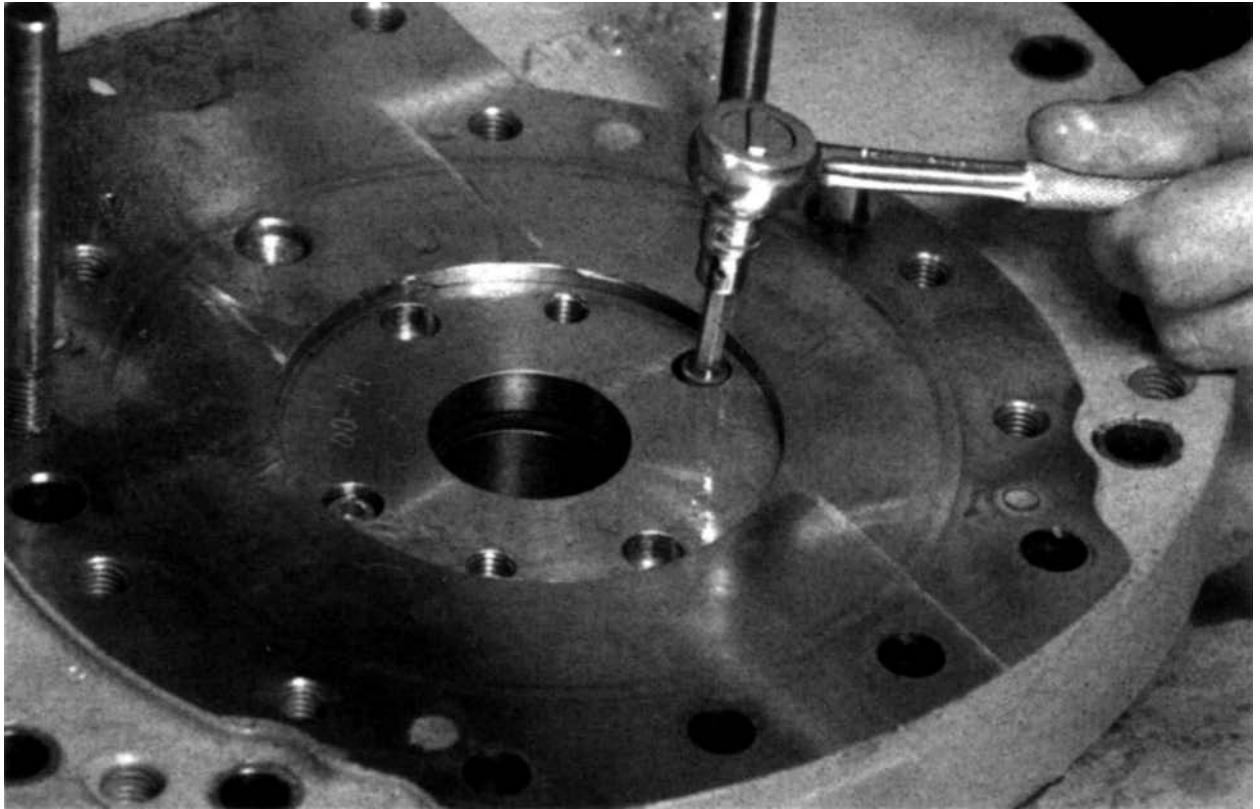

Figure 59 — Slide Seal Adaptor

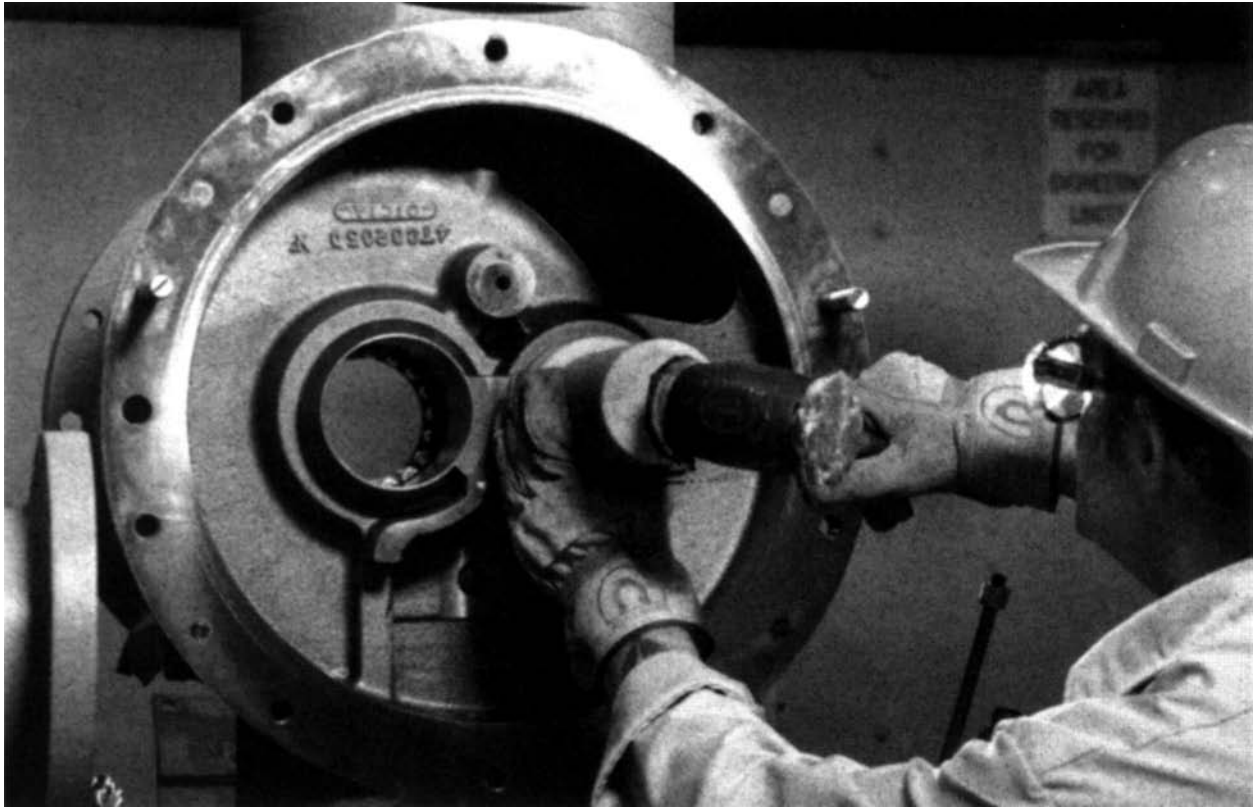

Figure 60 — Compressor Reassembly

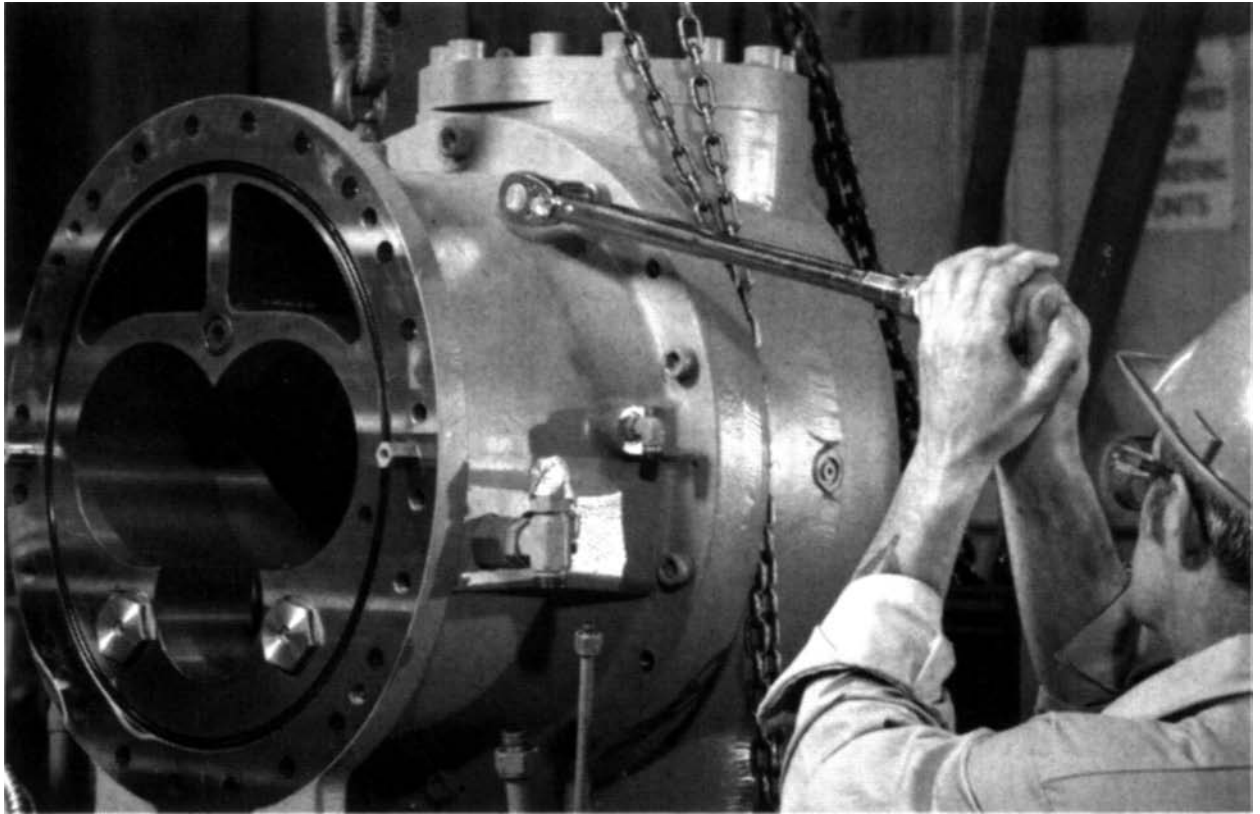

Figure 61 — Rotor Casing



Figure 62 — Rotors



Figure 63 — Heating Roller Bearings

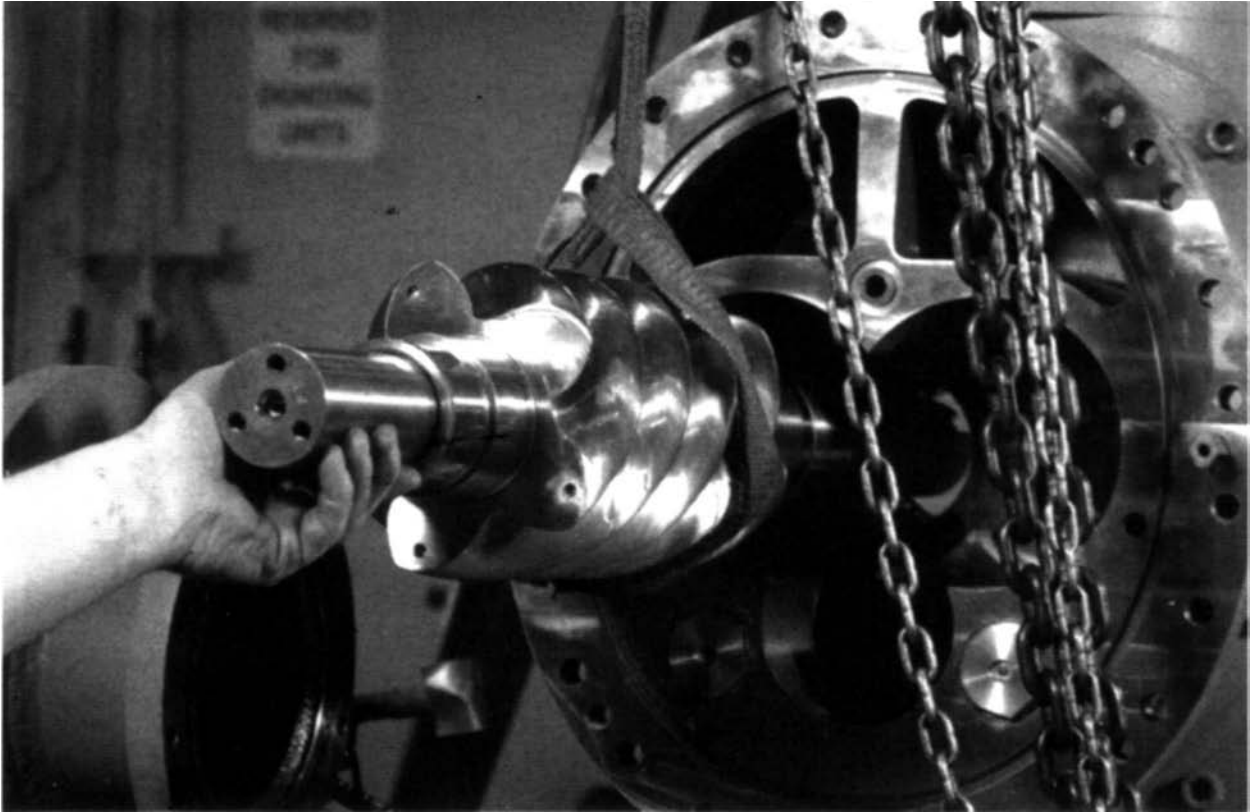

Figure 64 — Male Rotor Replacement

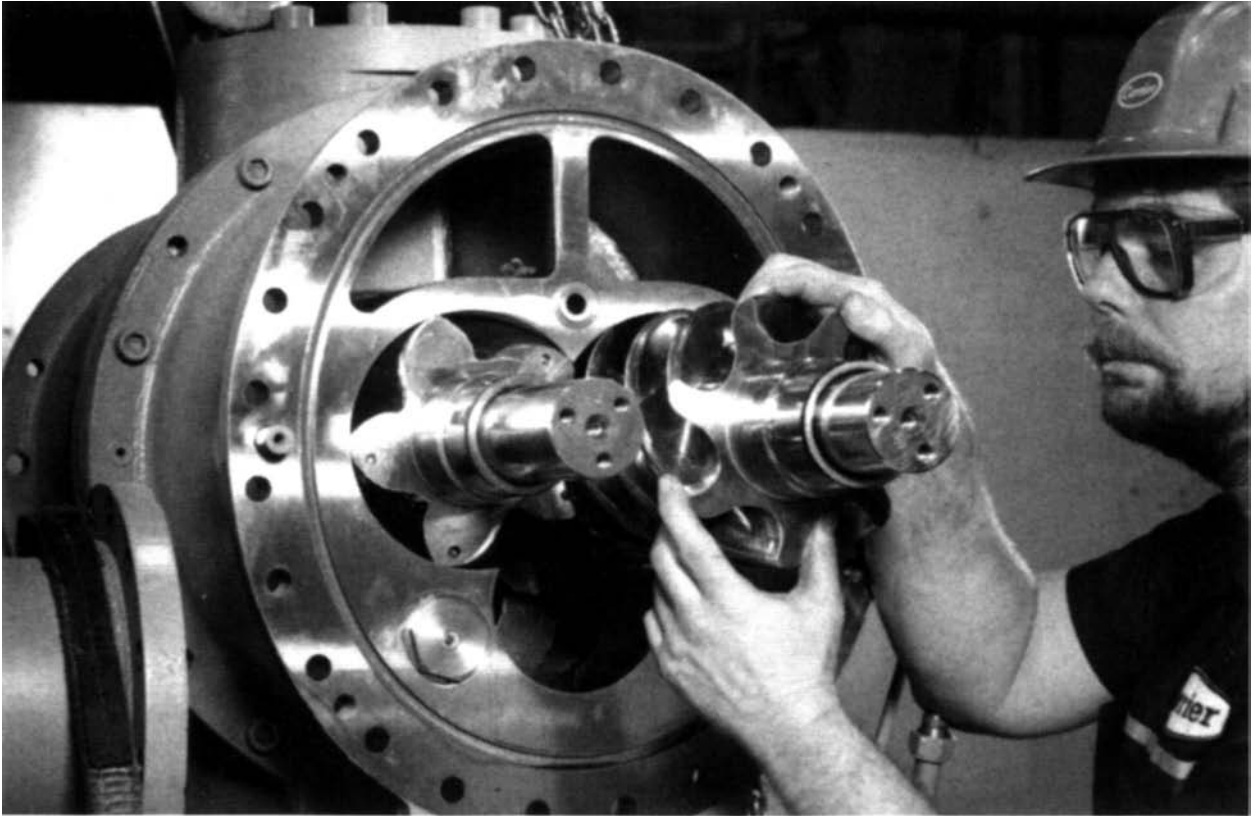

Figure 65 — Female Rotor Replacement

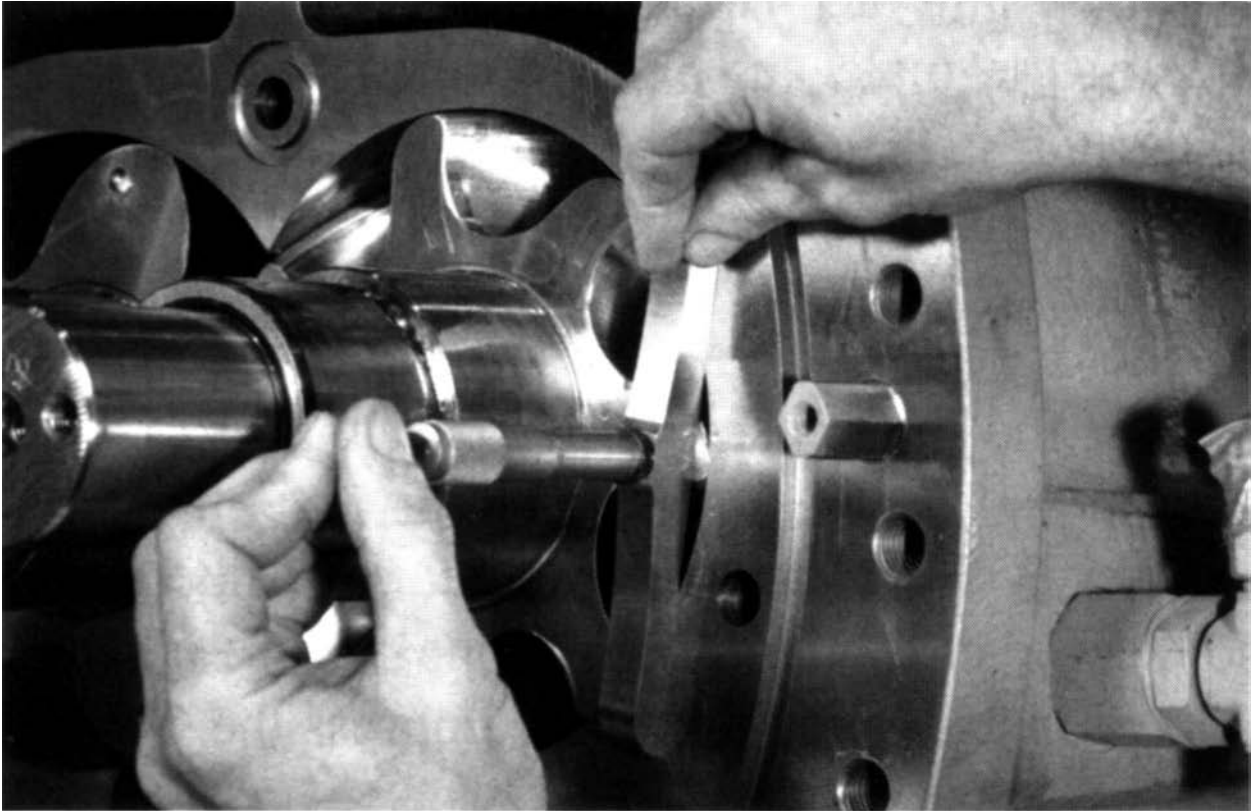

Figure 66 — Rotor Measure to Housing



Figure 67 — Outlet Casing Reassembly

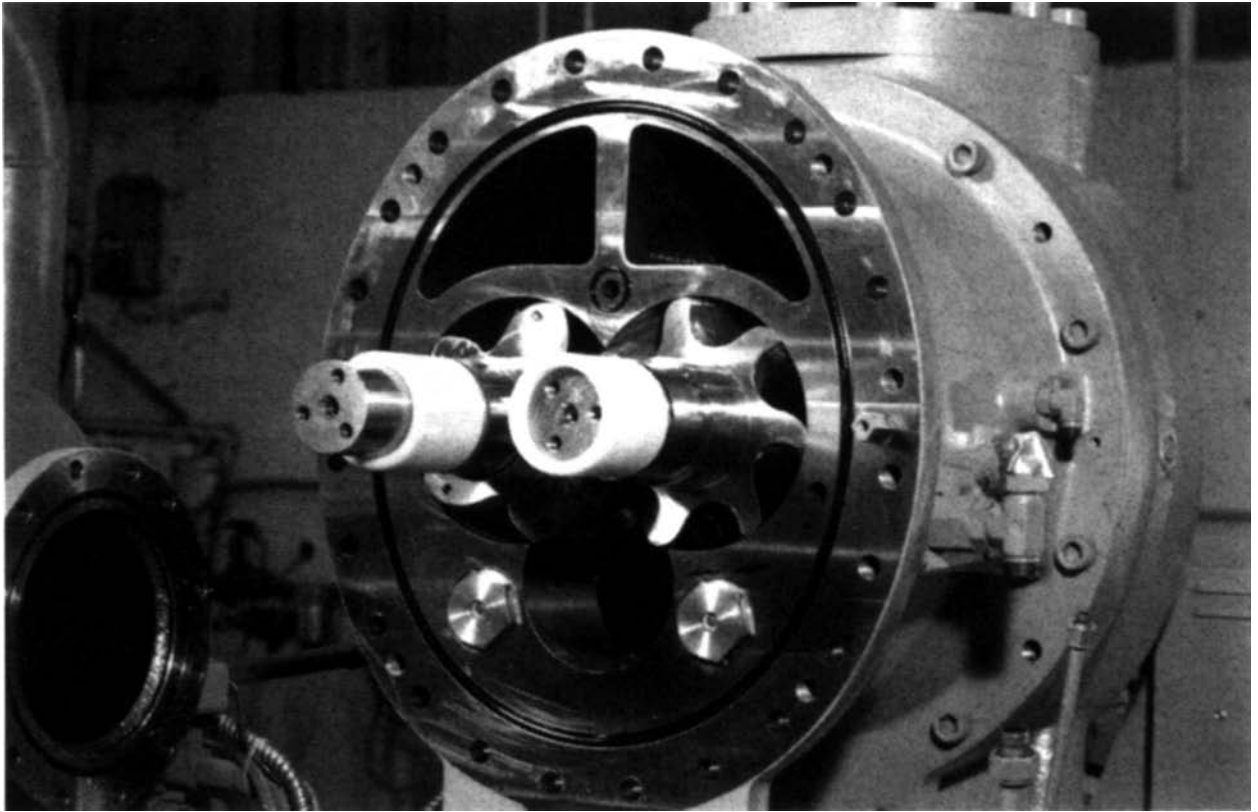

Figure 68 — Nylon Sleeve

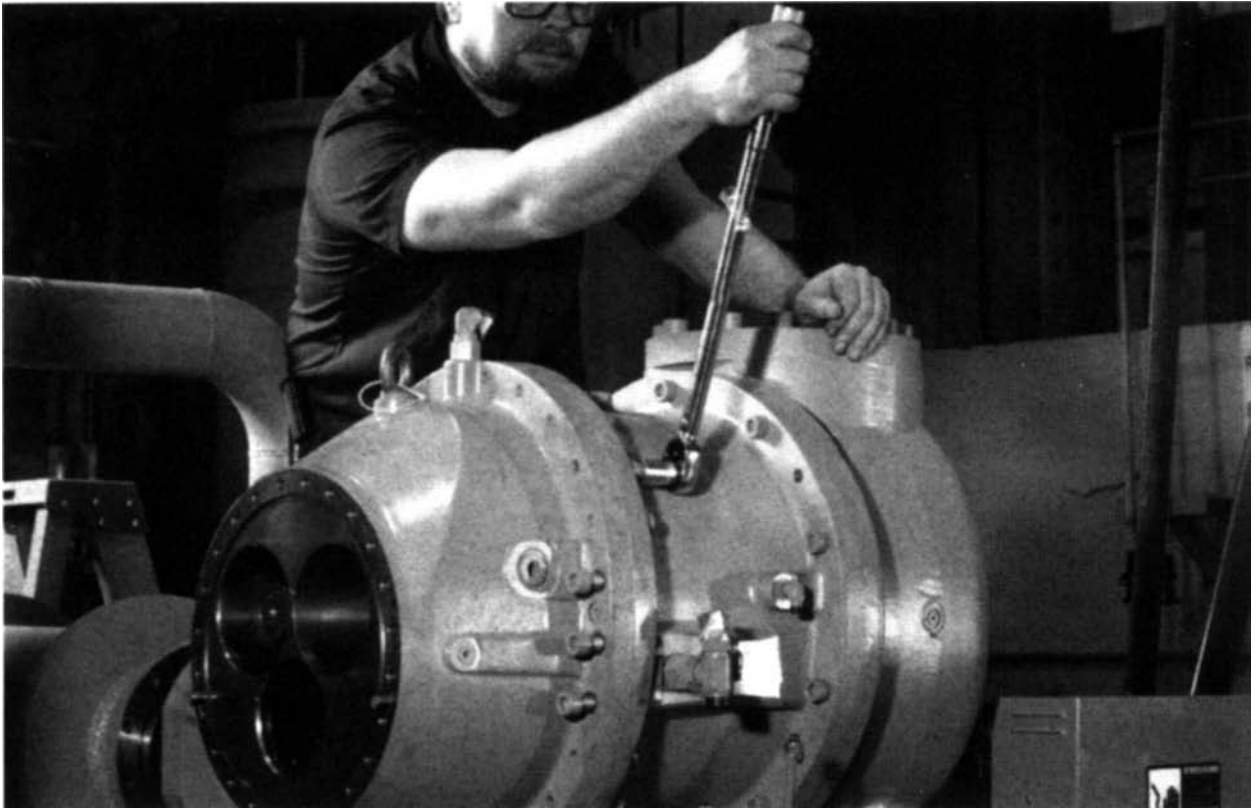

Figure 69 — Outlet Casing Rigging



Figure 70 — End Clearance (Rotors)

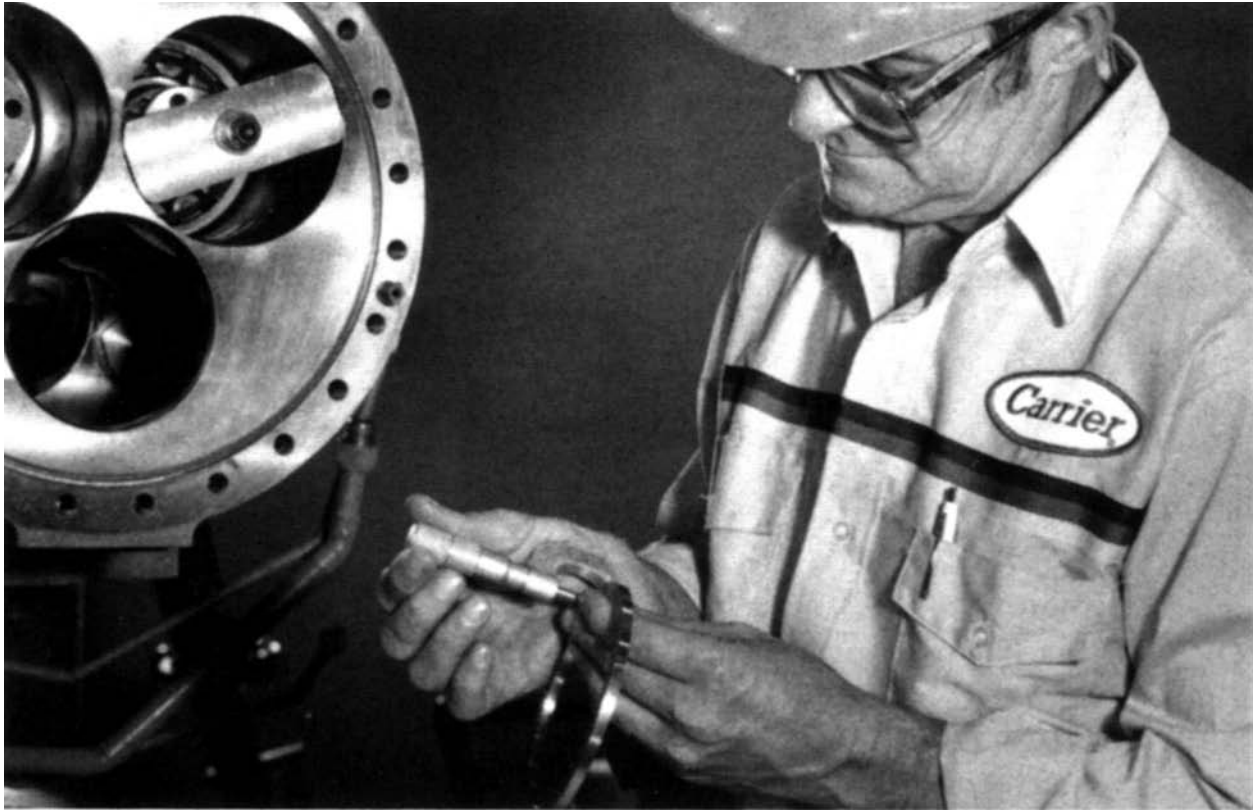

Figure 71 — Outer/Inner Bearing Spacer

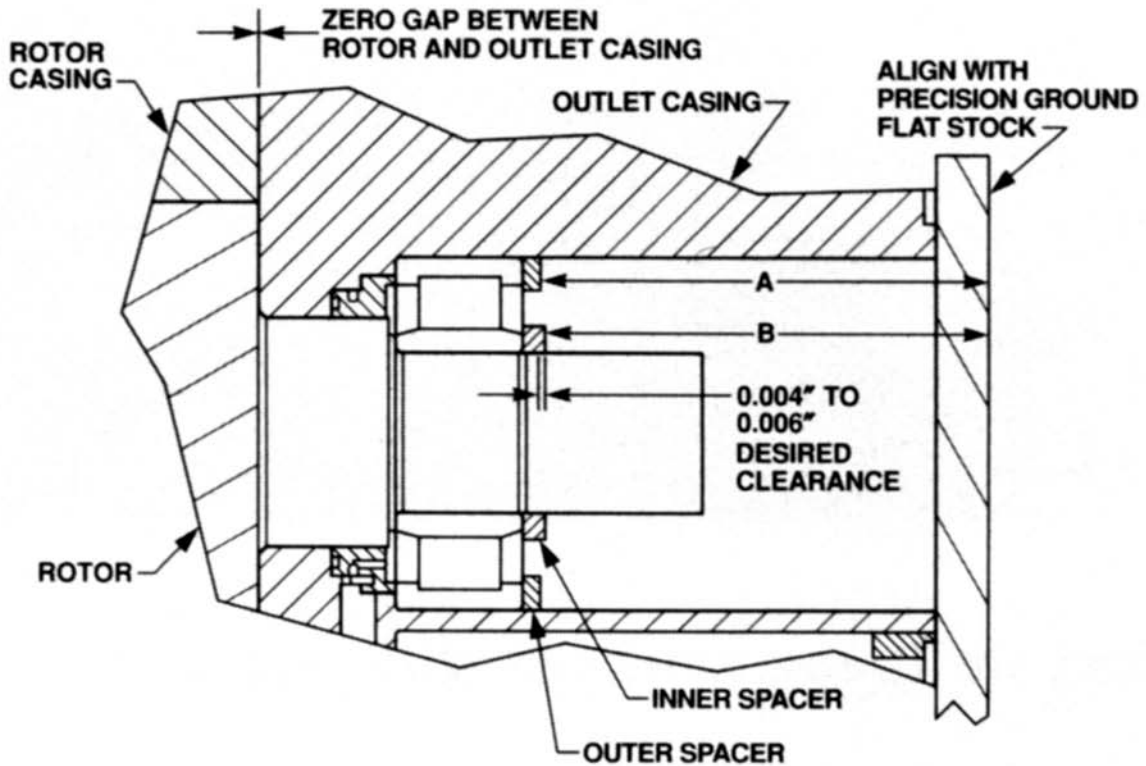

Figure 72 — Shim Calculation

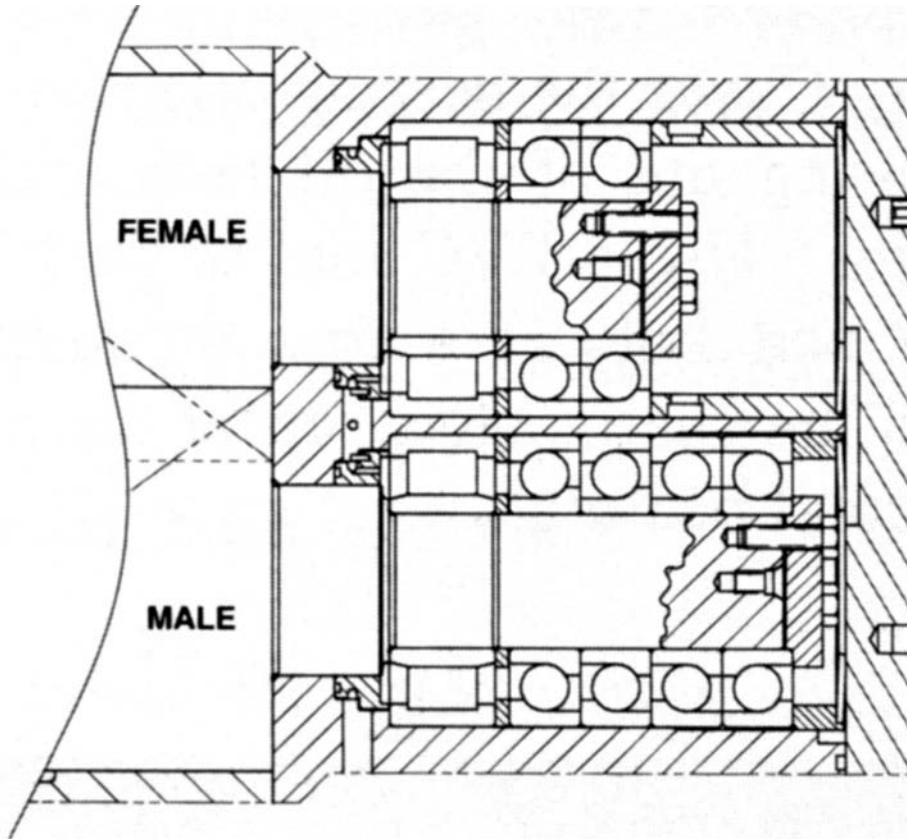

Figure 73 — Outlet Casing Ball Bearings

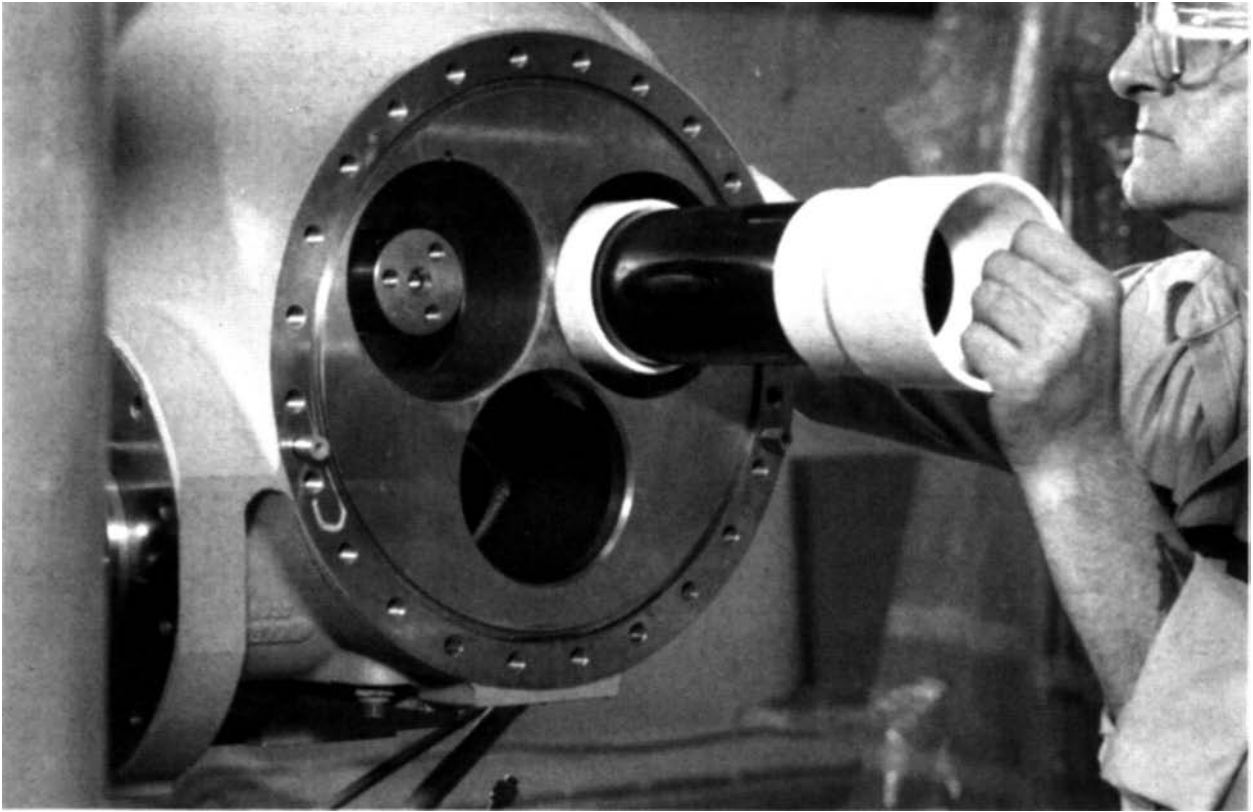

Figure 74 — Bearing Replacement

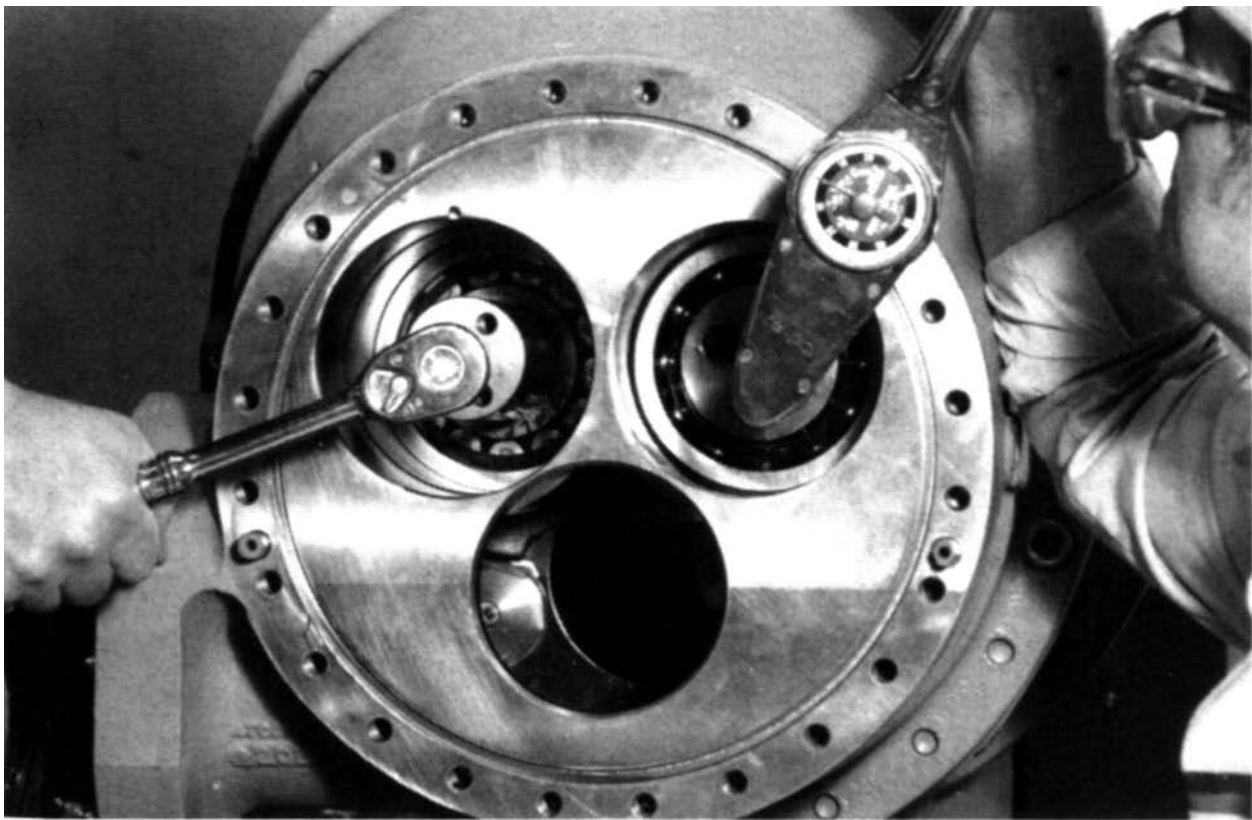

Figure 75 — Torque Rotor Bearing Bolts

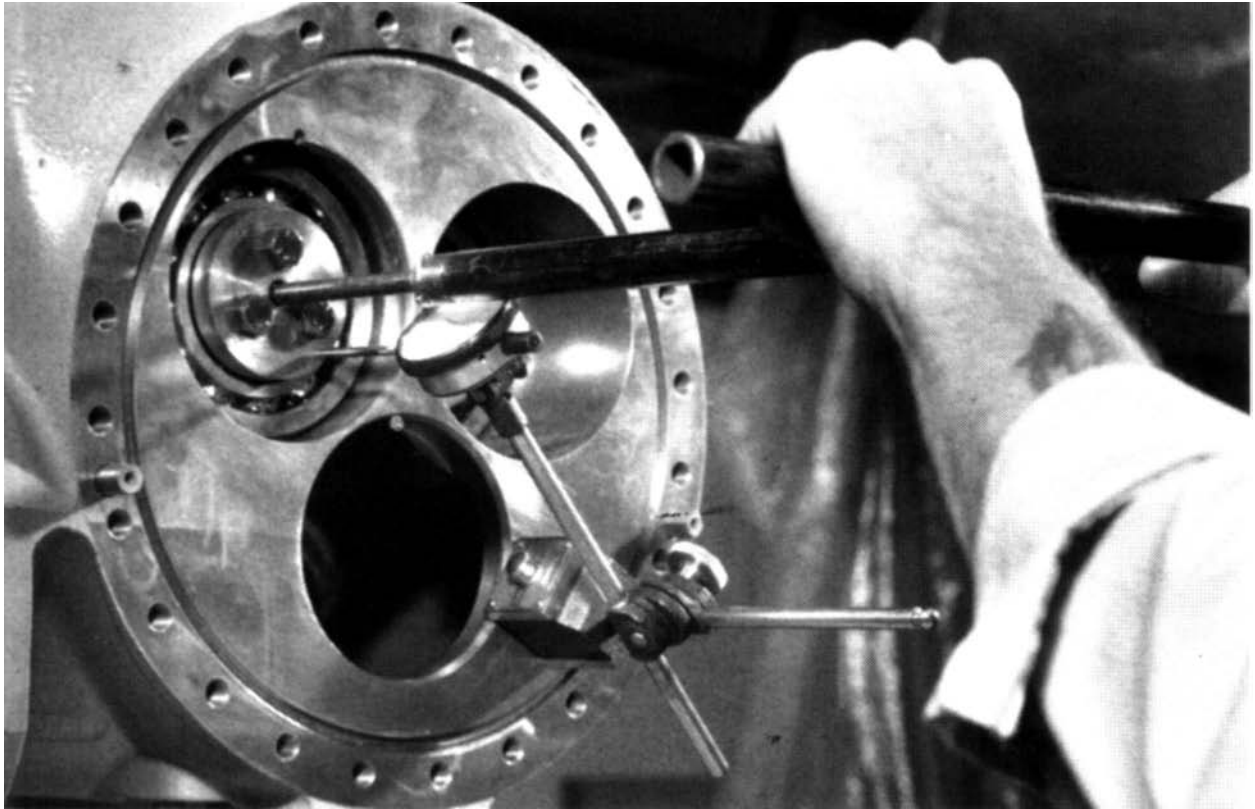

Figure 76 — T-Bar Tool/Dial Indicator

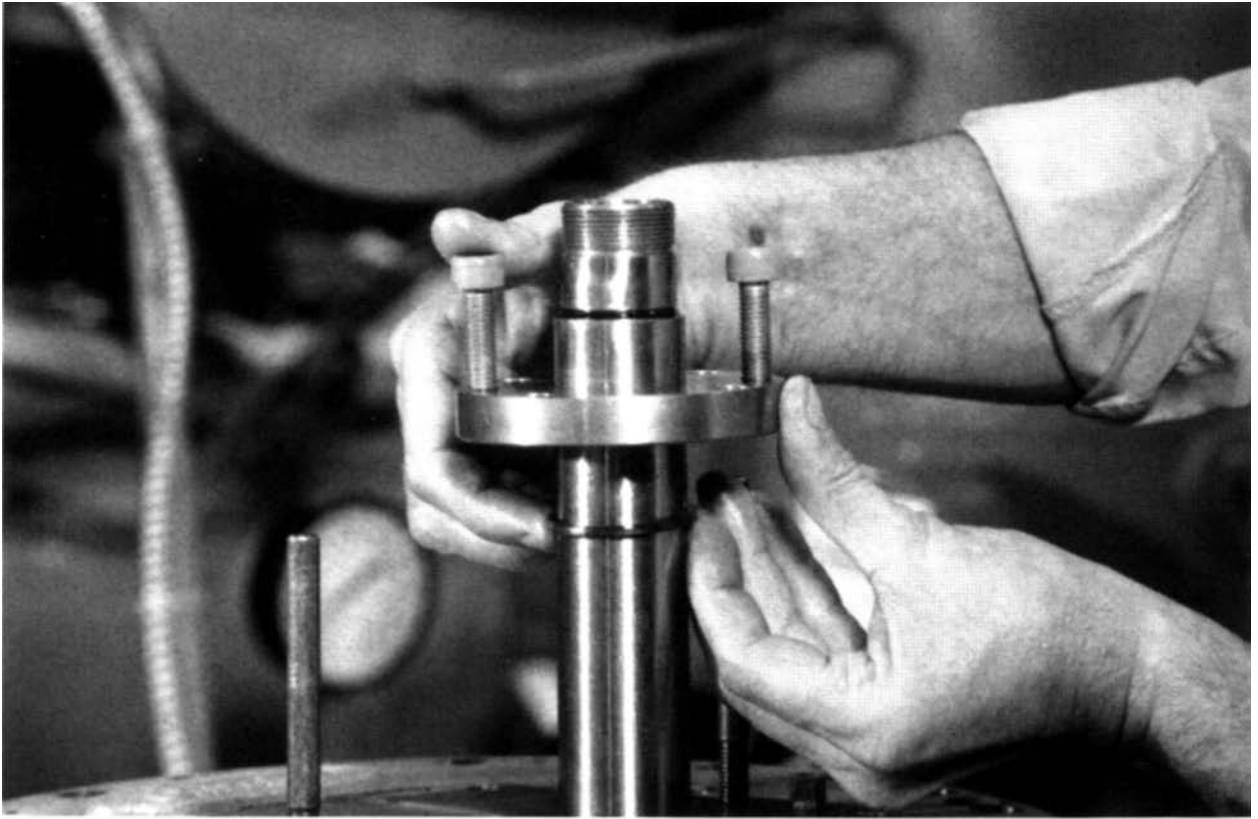

Figure 77 — Slide Valve

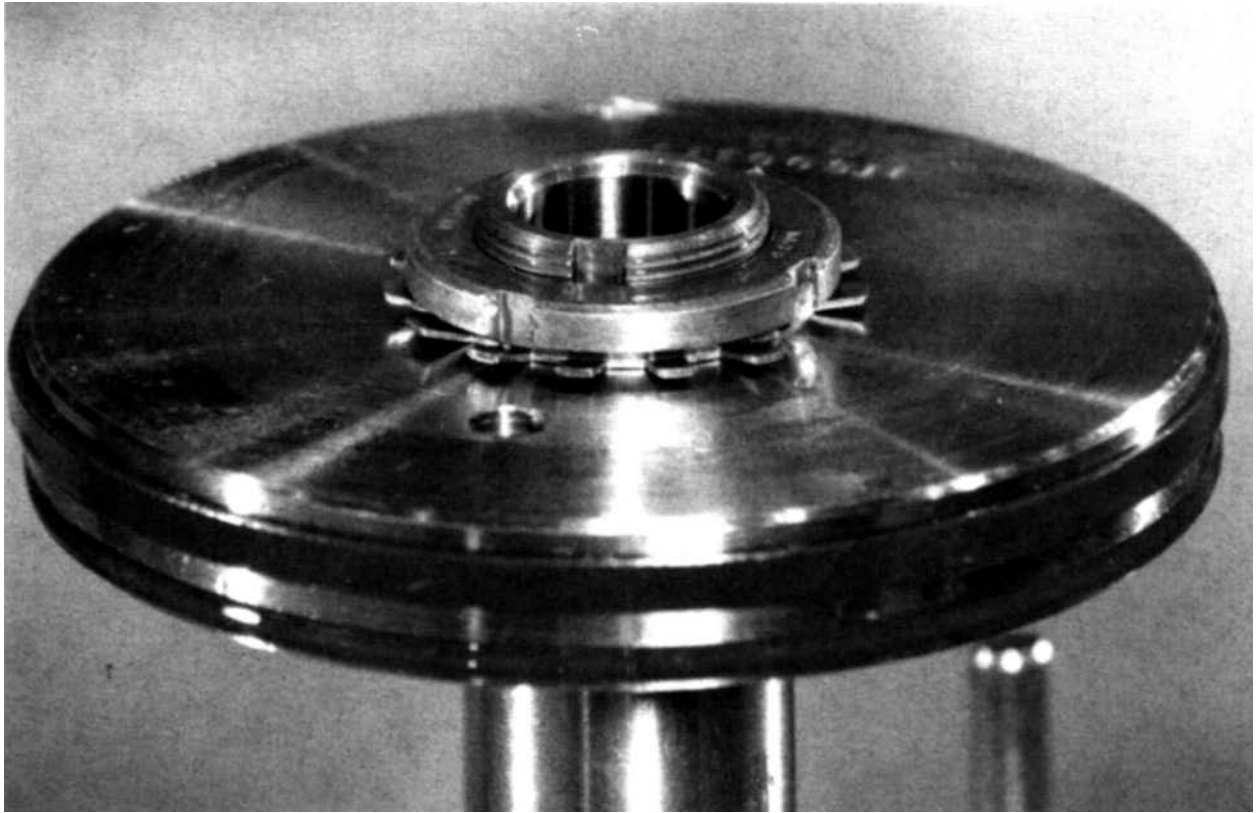

Figure 78 — Slide Valve Piston



Figure 79 — O-Ring/Slide Valve Casing

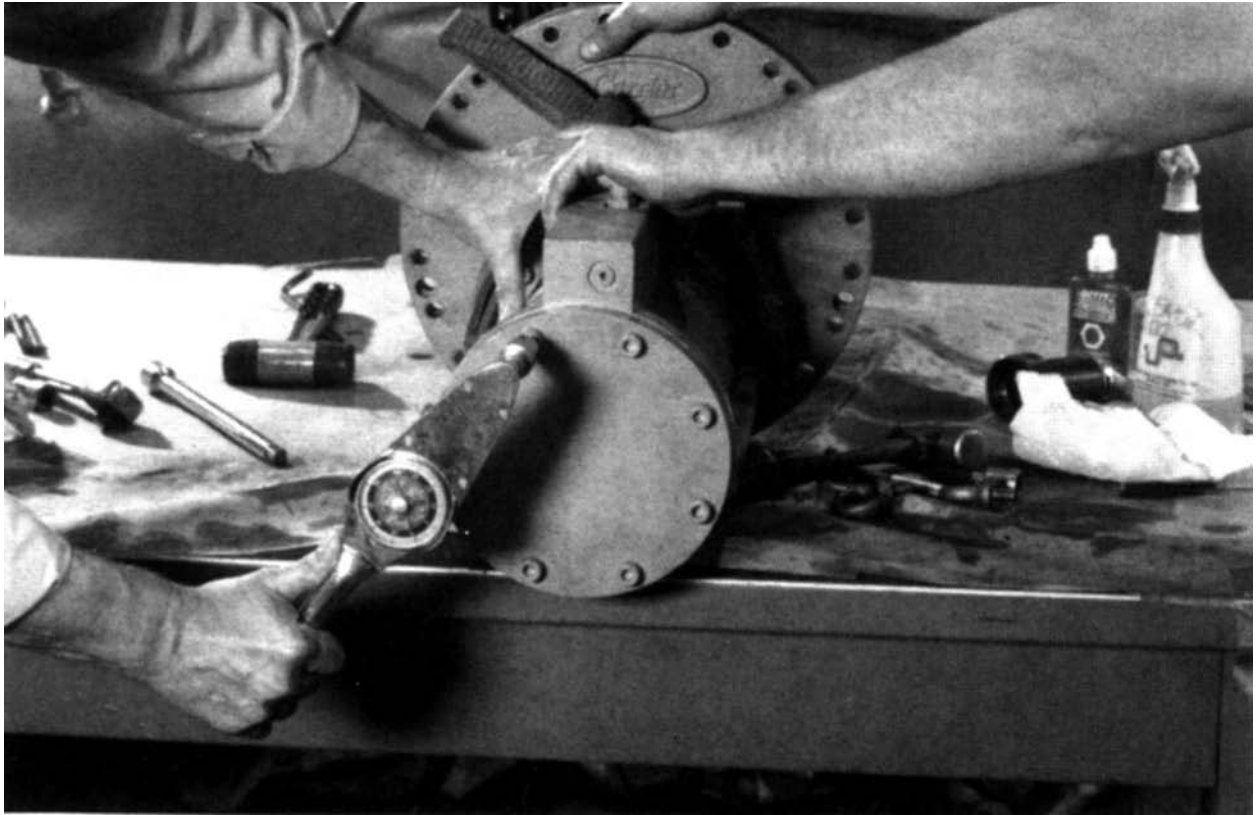

Figure 80 — Slide Assembly

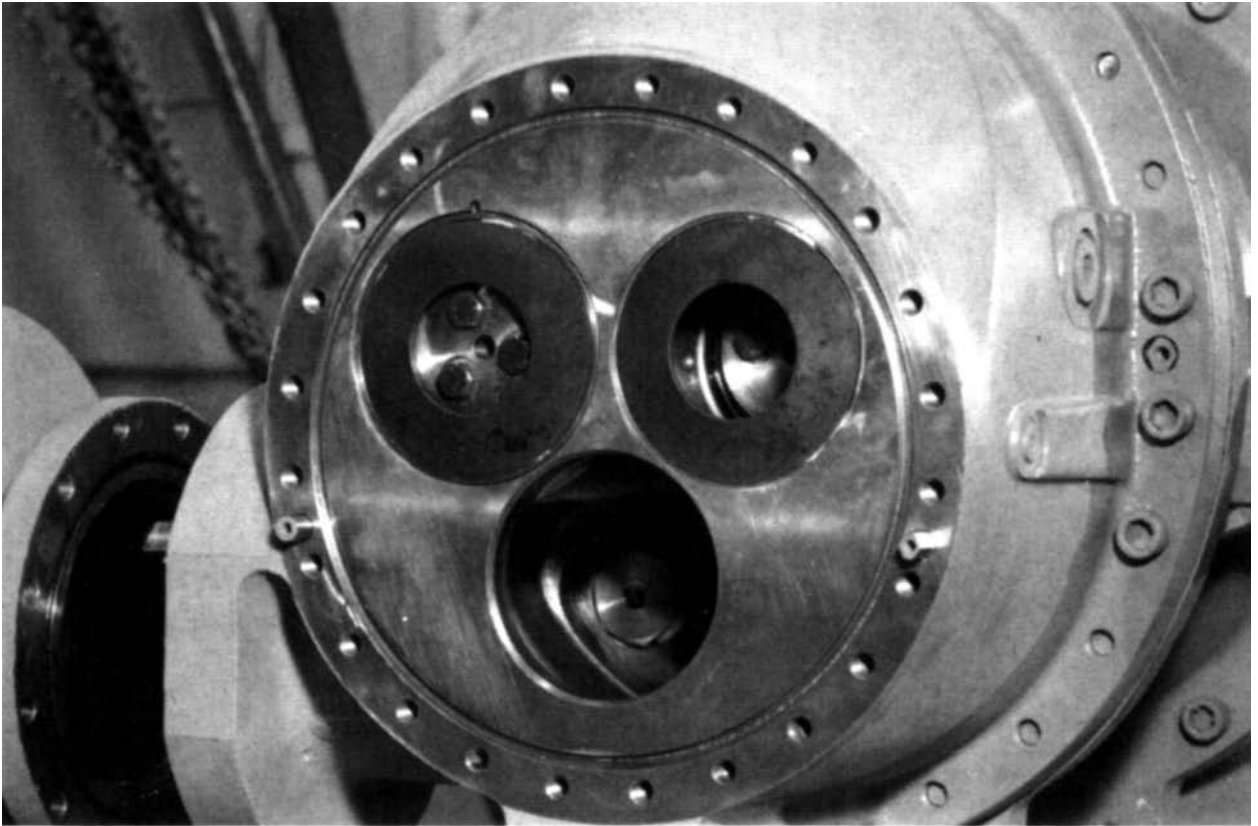

Figure 81 — Slide Valve Assembly

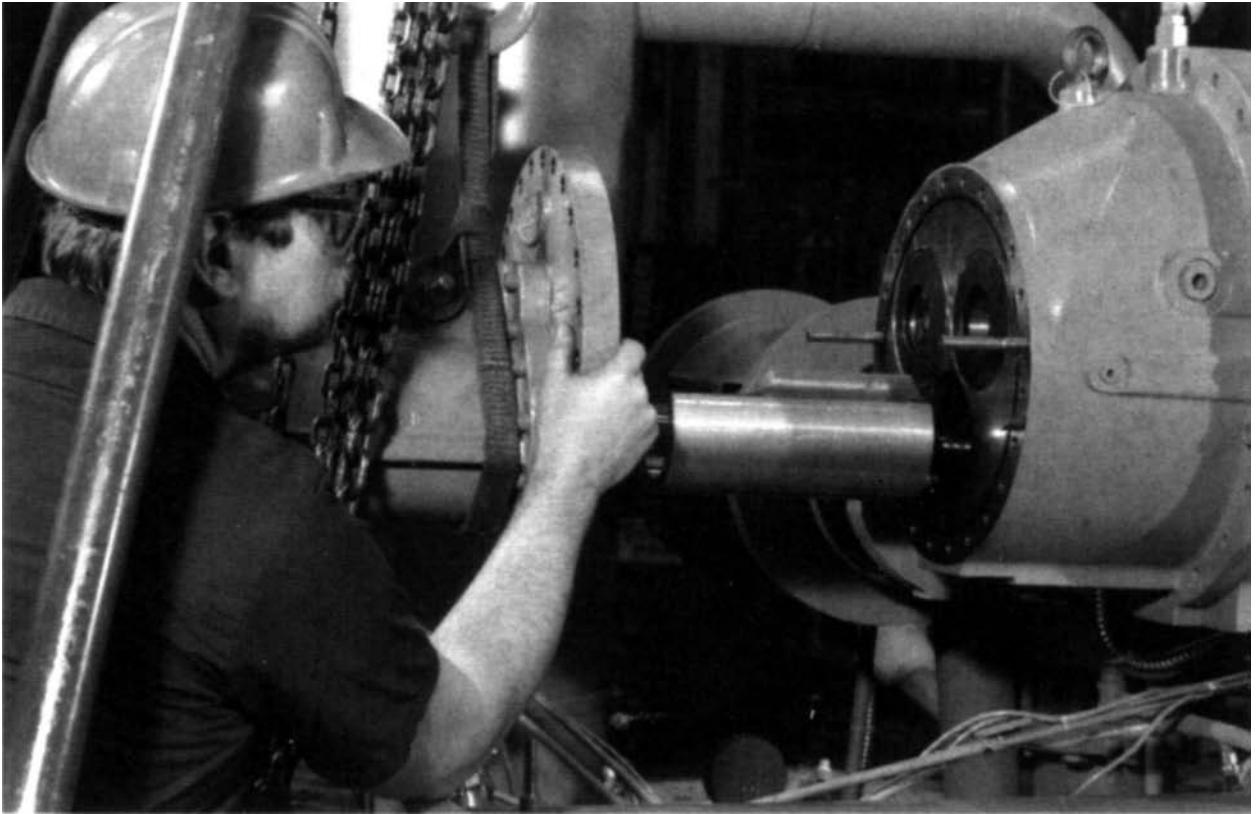

Figure 82 — Slide Valve Rigging

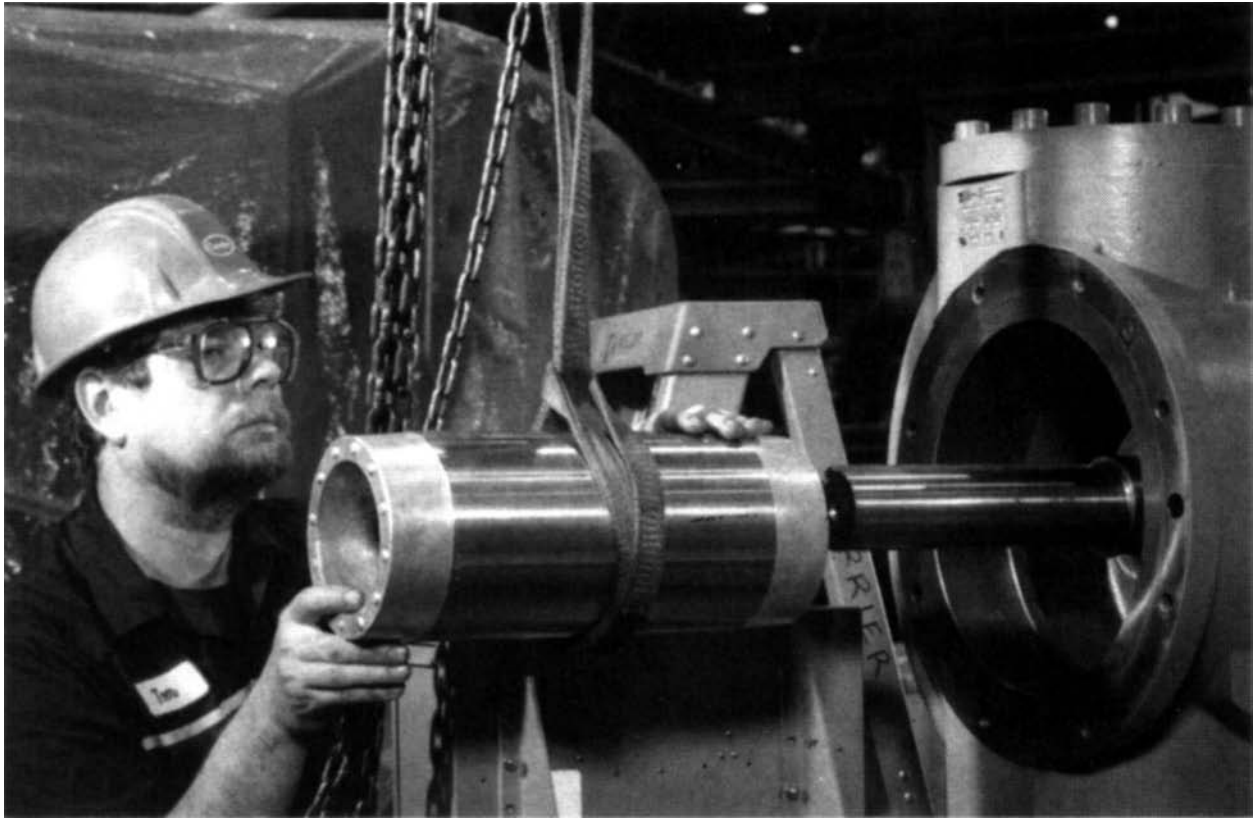

Figure 83 — Rotor Shaft

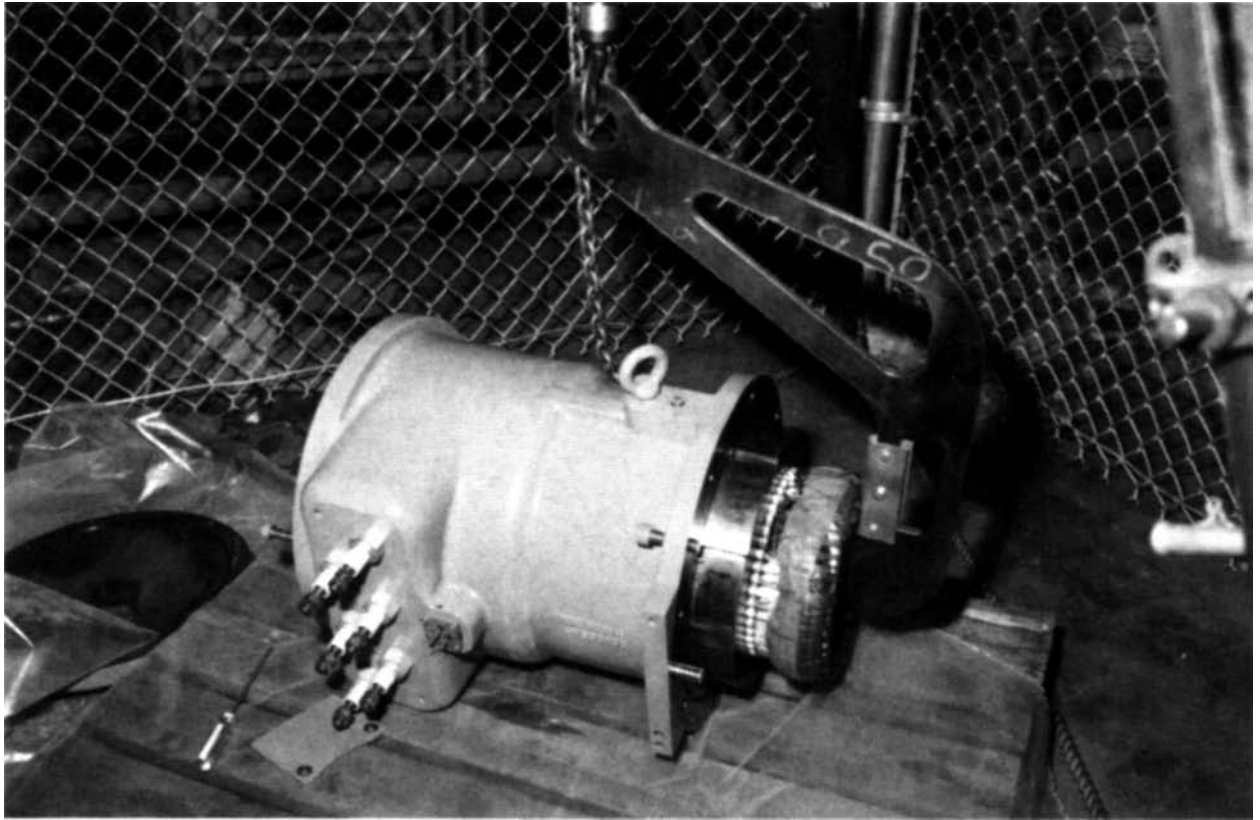

Figure 84 — Stator Replacement

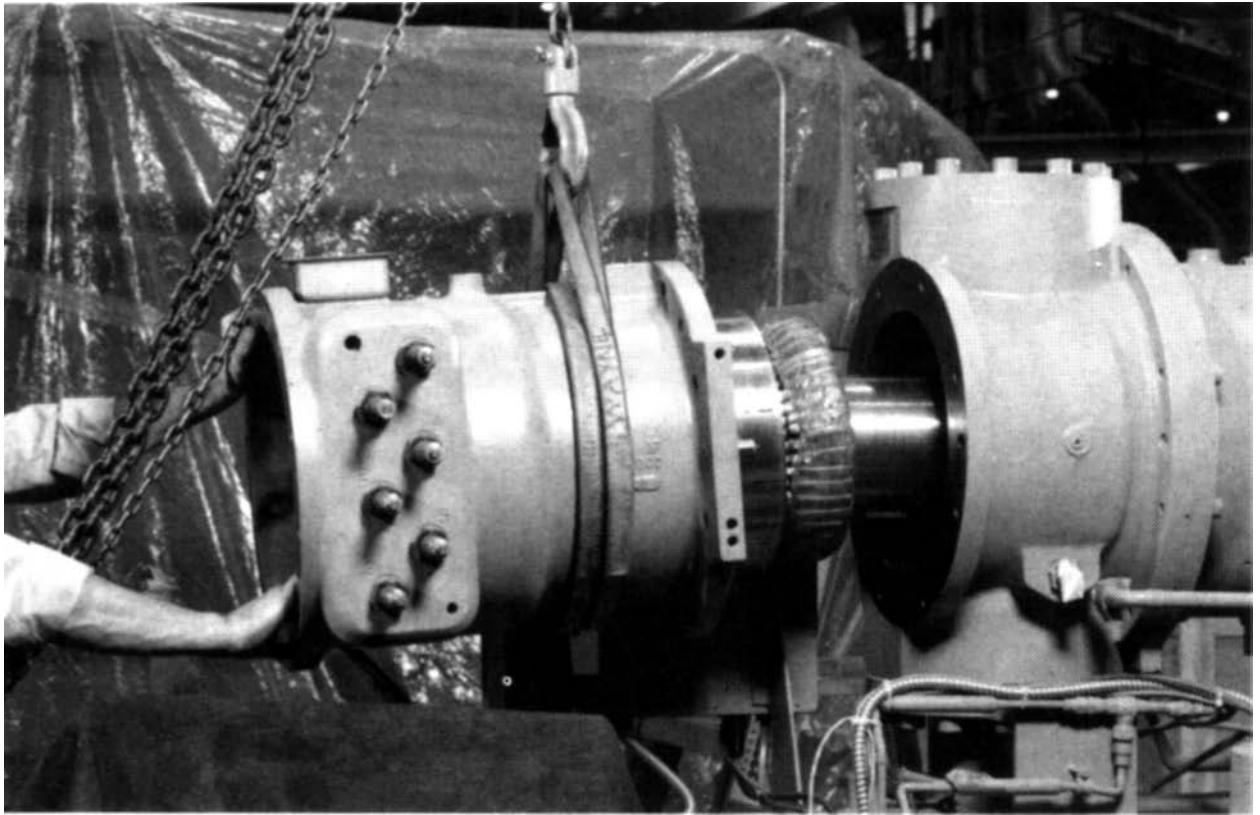

Figure 85 — Motor Casing

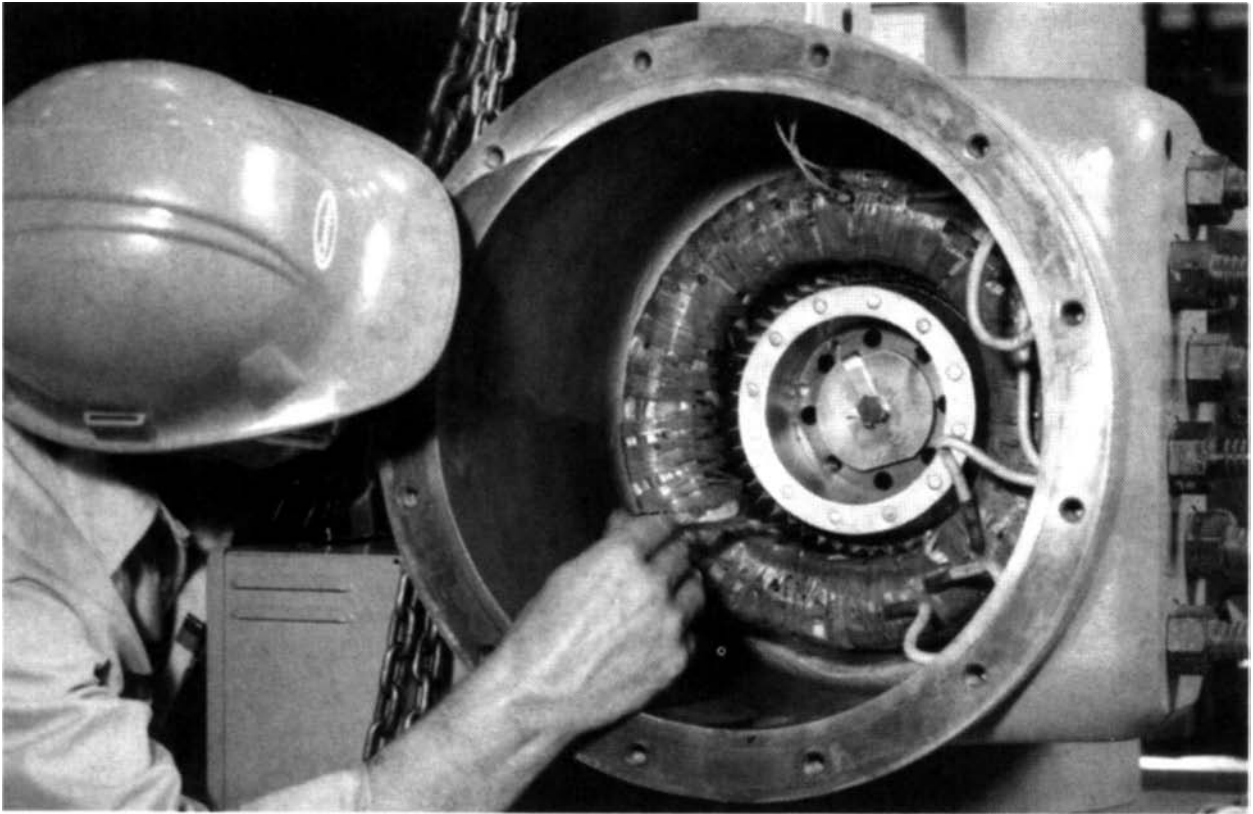

Figure 86 — Compressor

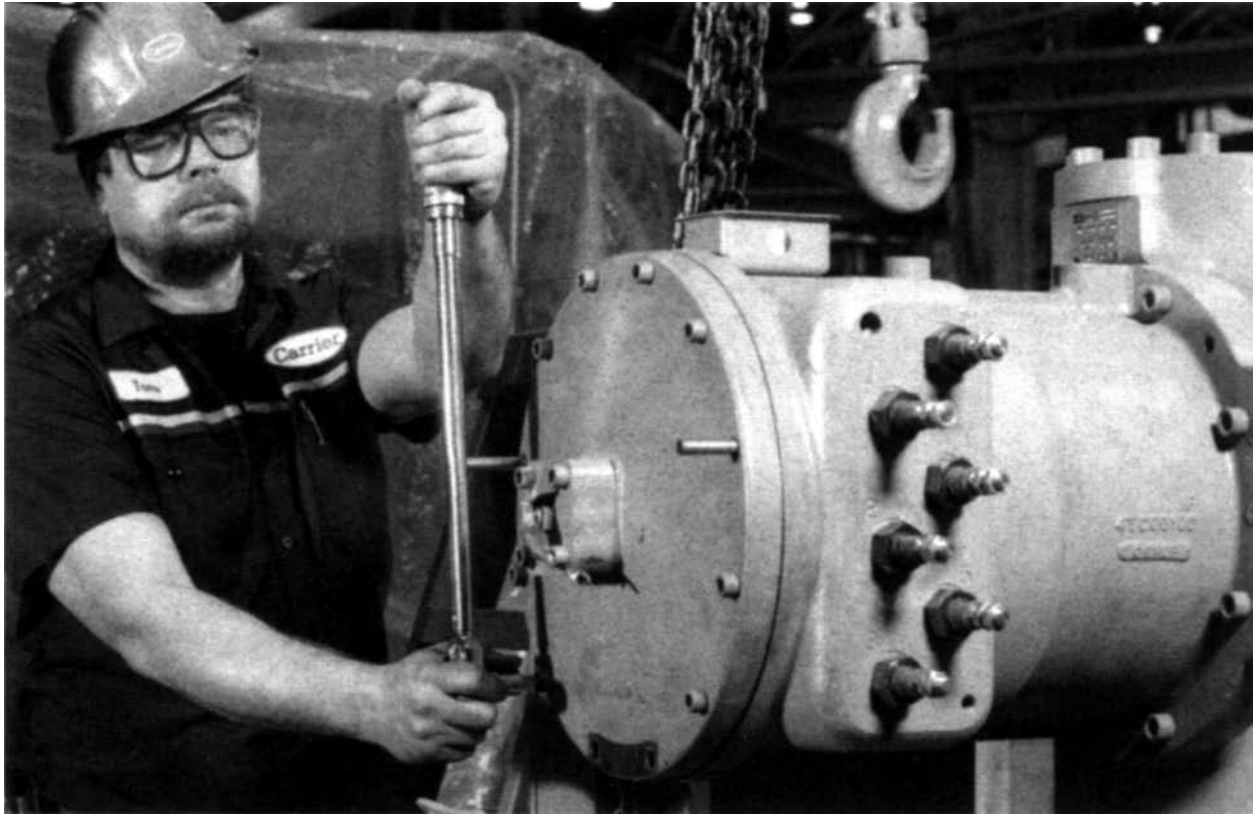

Figure 87 — Motor End Cover O-Ring

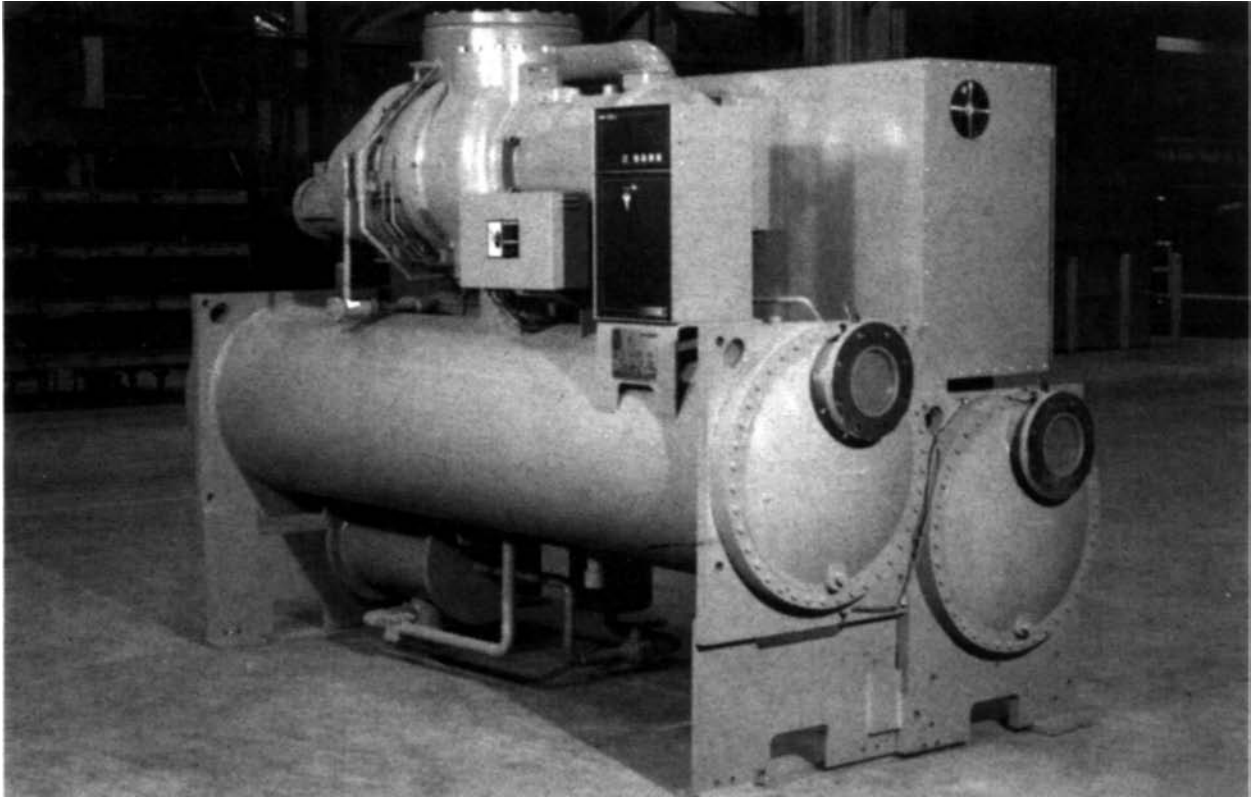

Figure 88 — Completed Chiller Assembly (Front View)

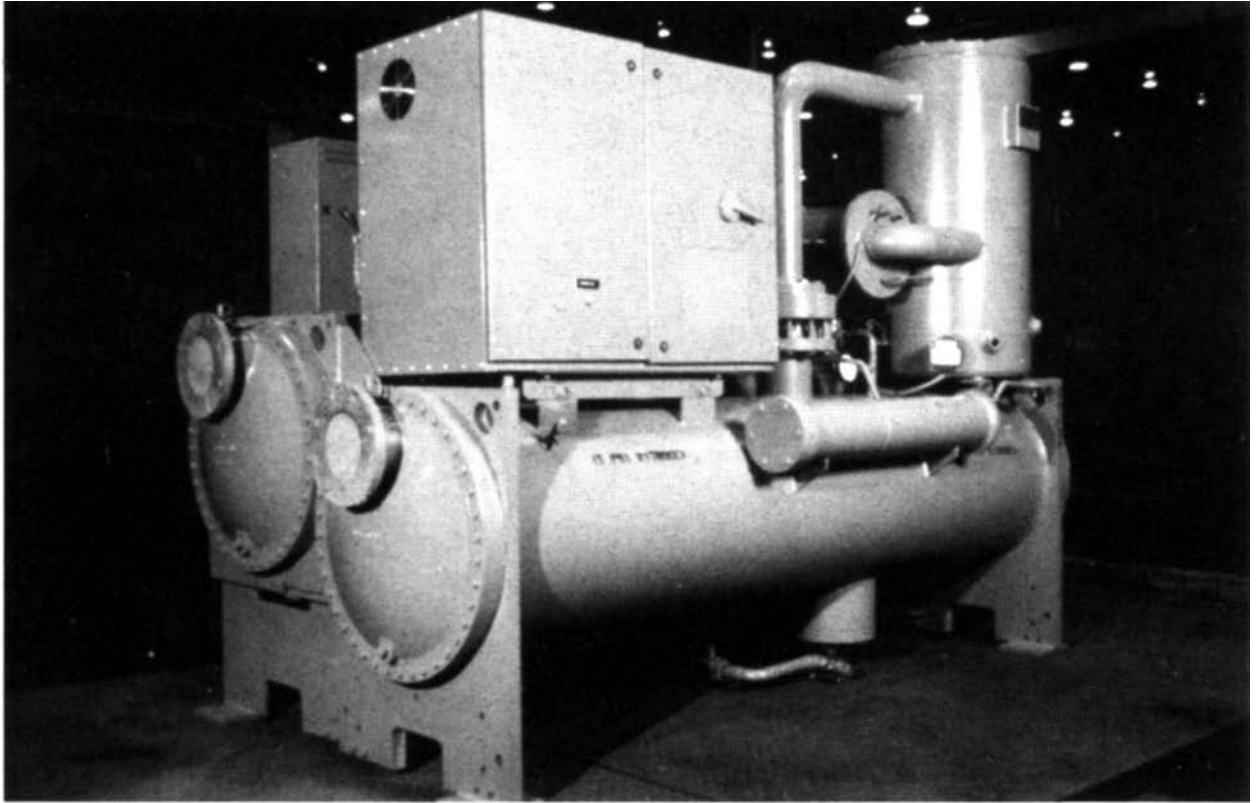
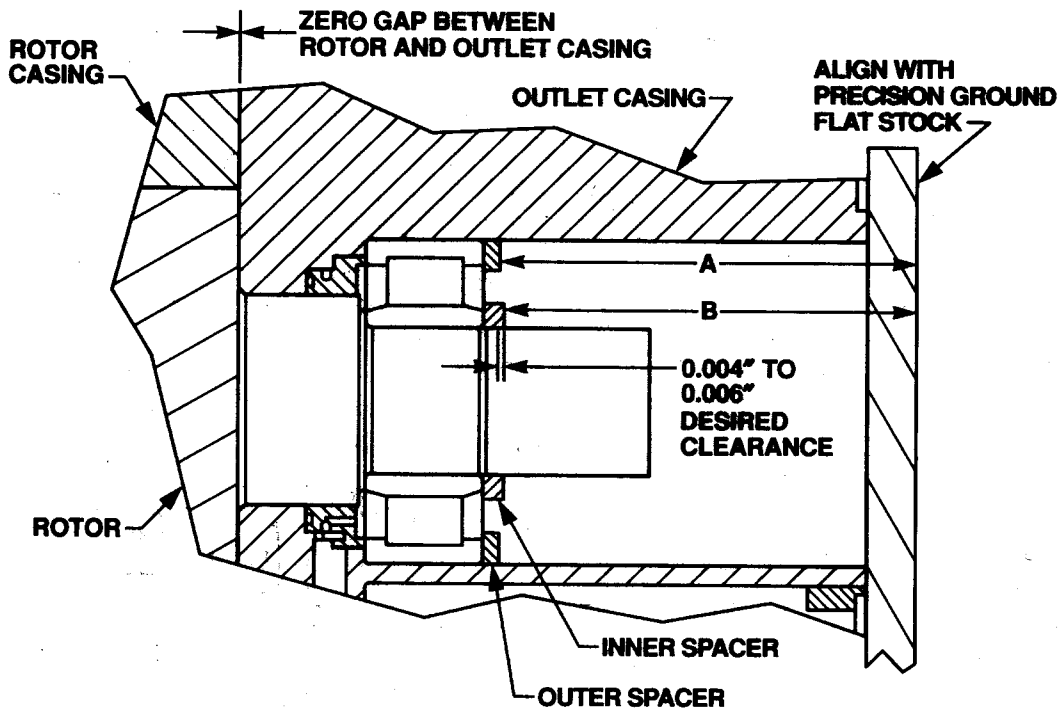
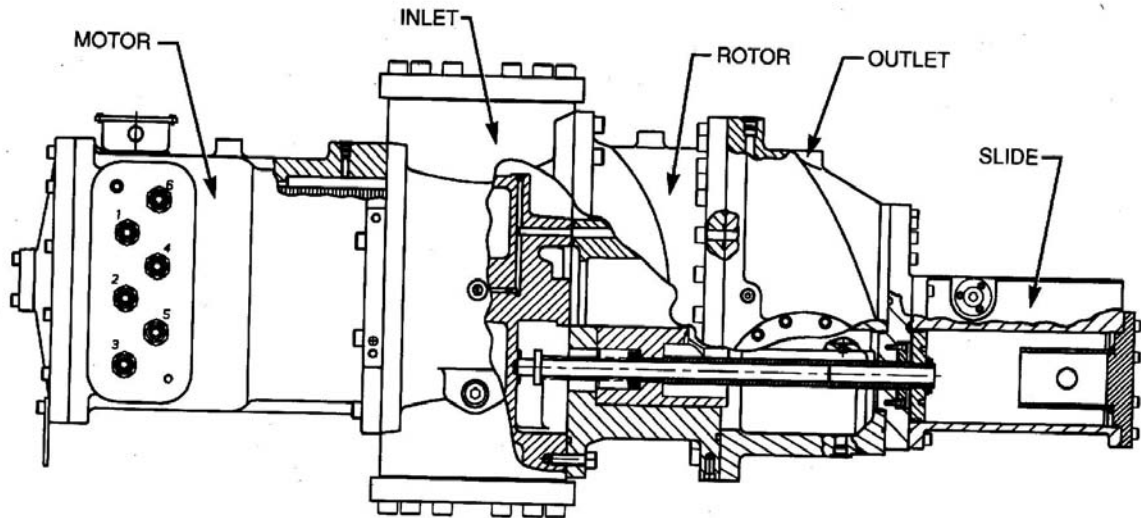

Figure 89 — Completed Chiller Assembly (Rear View)



	EXAMPLE ADD SHIM	EXAMPLE REMOVE SHIM	ADD - REMOVE SHIM	
Step A. Measure the outer distance (inches)	6.250	6.250		
Step B. Measure the inner distance (inches)	6.249	6.243		
Step C. Add desired clearance of .005" to Step B.	6.249 + .005 ----- 6.254*	6.243 + .005 ----- 6.248*	+ _____	+ _____
<i>*NOTE: If Step "C" is greater than Step "A" Add Shim. If Step "C" is smaller than Step "A" Remove Shim.</i>				
Step D. Calculate the difference between Step A and Step C. Result is amount of shim to be added or removed from inner spacer.	6.254 - 6.250 ----- .004	6.250 - 6.248 ----- .002	- _____	- _____
	Add	Remove		

Rotor End Clearance Worksheet



23XL Casings — Male Side View

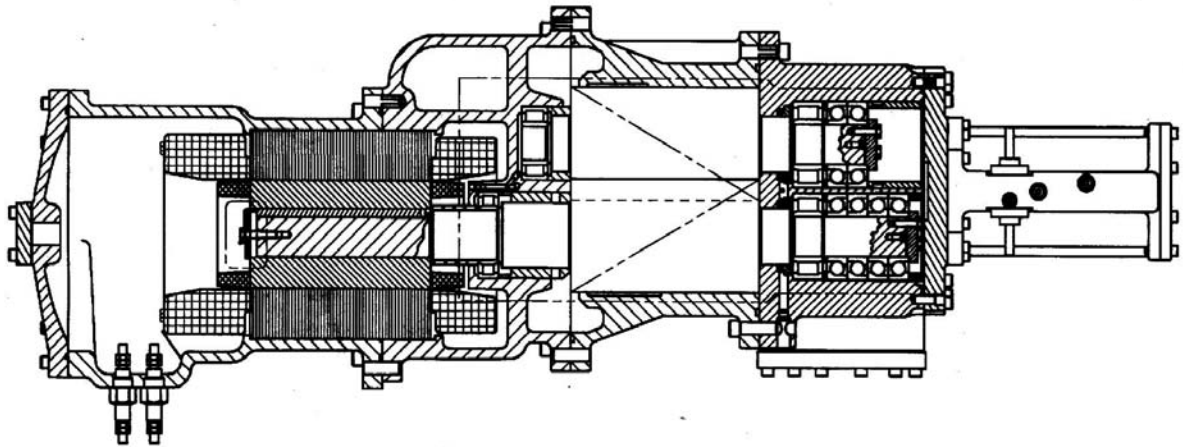

23XL Casings — Top Sectional View

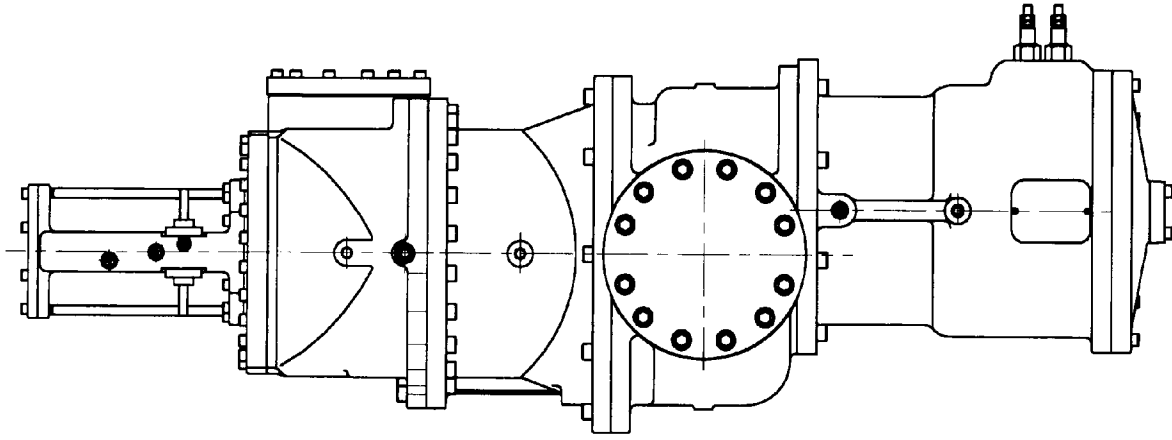

23XL Casings — Top View

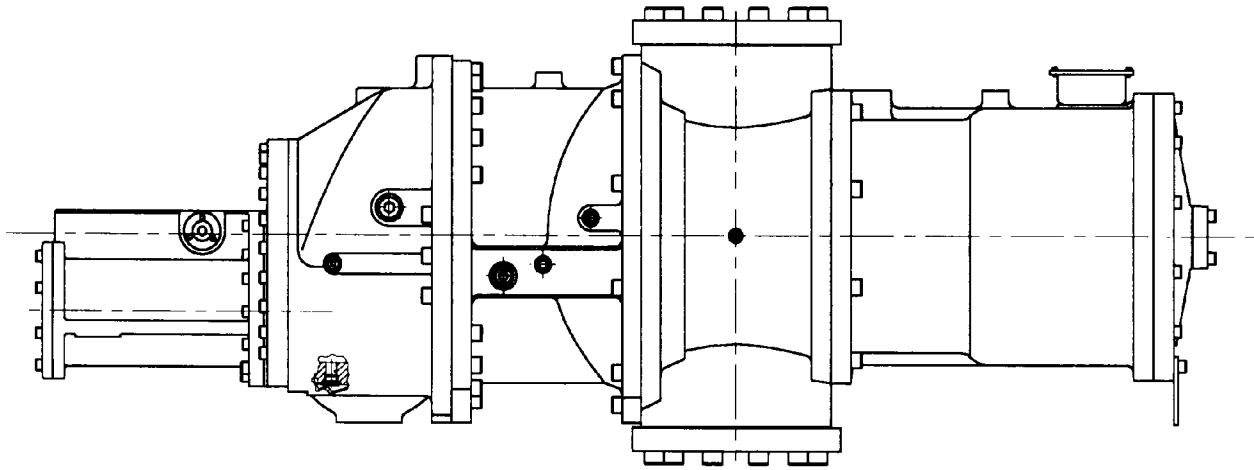

23XL Casings — Female Side View

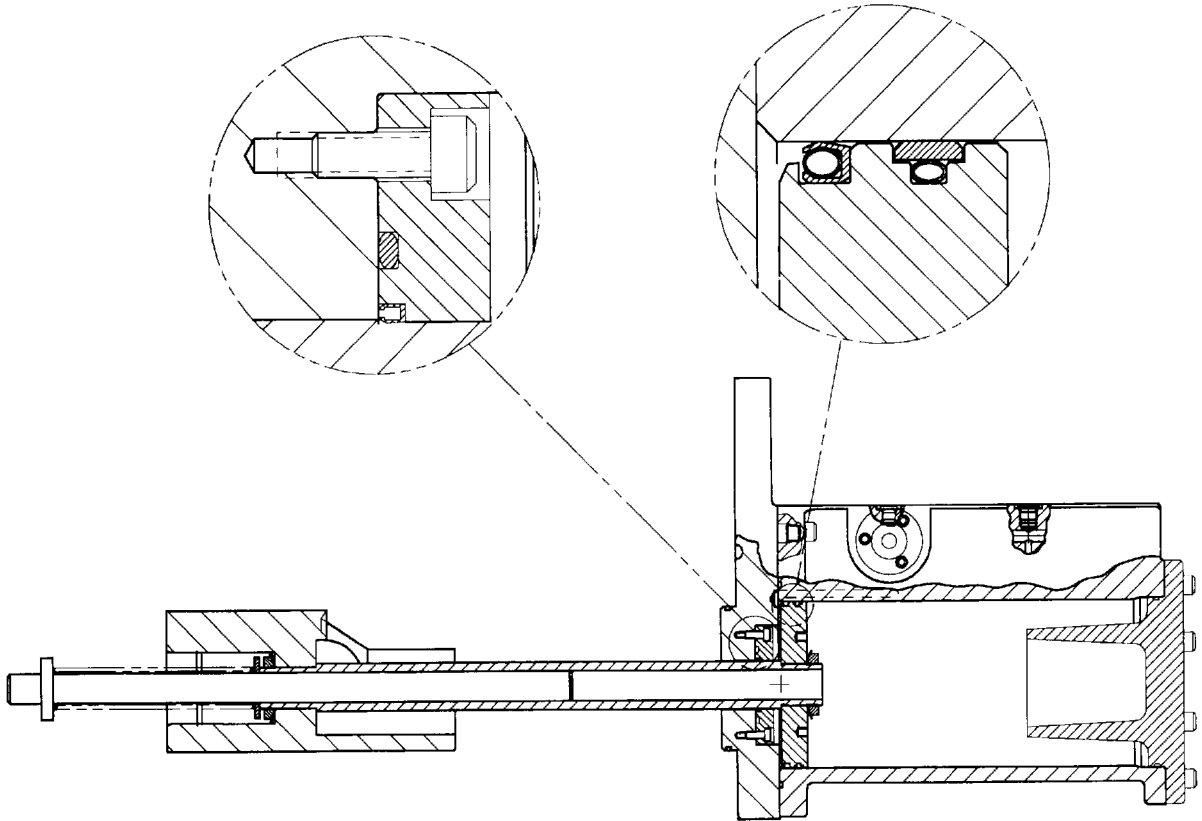

Slide Valve Assembly — Two Piece Casing Shown

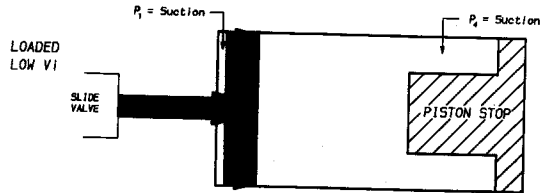
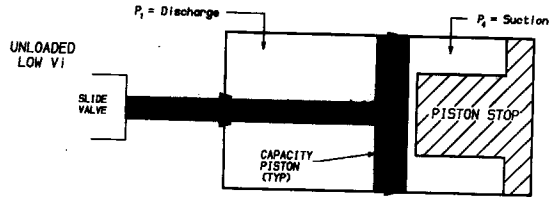

SLIDE CASING (INTERNAL)

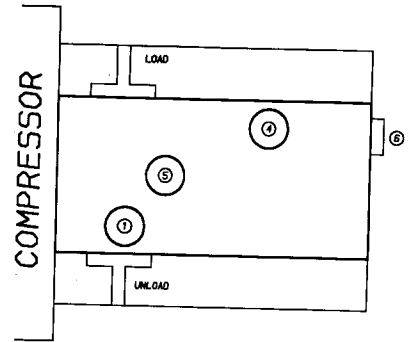

SLIDE CASING (EXTERNAL)

RESPECTIVE PRESSURE/PORT CONNECTION READINGS:

PORT ① = P_1 PORT ② = P_2

GENERAL NOTES:

- PORTS ① ② WILL ALWAYS READ SUCTION PRESSURE
- PORT ③ IS DISCHARGE PRESSURE OIL INLET PORT

Slide Casing (Internal and External)



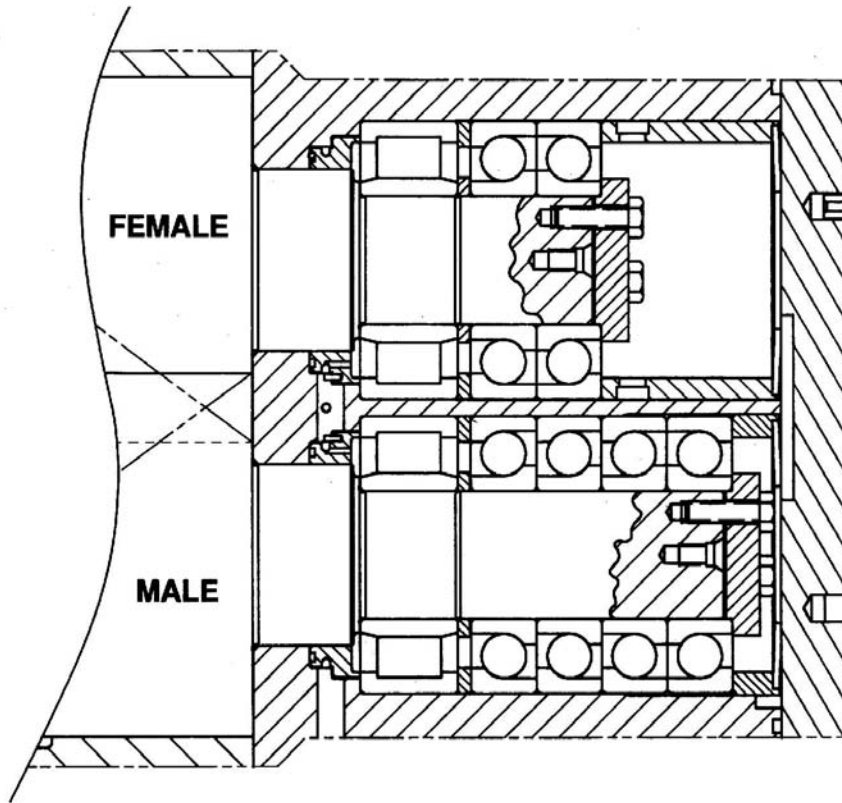

Rotor Bearings

200 TON SCREW COMPRESSOR TORQUE SPECIFICATION CHART FOR METRIC AND AMERICAN FASTENERS

CAP SCREW PART NO.	CAP SCREW SIZE & TYPE (mm)	GRADE	ASSEMBLY OPERATION	TORQUE		
				* Nm	LB-FT	LB-IN
8TC0091C	M5 X 0.8 X 12 S.H.	10.9	(B) FUSITE-MOTOR CASING, SLIDE SEAL RETAINER-CYLINDER STOP	4.1-5.4	3-4	36-48
8TC0092C	M6 X 1 X 16 S.H.	10.9	(B) CONTROL VALVES-SLIDE CASING SLIDE SEAL ADAPTOR-SEPARATOR PLATE	6.8-9.5	5-7	60-84
8TC0103C	M10 X 1.5 X 35 H.H.	10.9	BRG RETAINER-MALE ROTOR, BRG RETAINER-FEMALE ROTOR	41-47	30-35	
8TC0094C	M10 X 1.5 X 40 S.H.	10.9	SLIDE VALVE COVER-SLIDE CASING SLIDE CASING-SEPARATOR PLATE	41-47	30-35	
8TC0104C	M10 X 1.5 X 50 H.H.	10.9	MOTOR ROTOR-MALE ROTOR	19-24	14-18	
(B) 8TC0096C	M12 X 1.75 X 40 S.H.	10.9	(B) VALVE PAD-MOTOR COVER	68-81	50-60	
8TC0097C	M12 X 1.75 X 50 S.H.	10.9	(B) MOTOR COVER-MOTOR CASING, SEPARATOR PLATE-OUTLET CASING DISCHARGE COVER-OUTLET CASING	68-81	50-60	
8TC0098C	M12 X 1.75 X 60 S.H.	10.9	(B) MOTOR END PLATE-MOTOR COVER-MOTOR CASING	68-81	50-60	
8TC0099C	M12 X 1.75 X 80 S.H.	10.9	SLIDE CASING-SEPARATOR PLATE-OUTLET CASING	68-81	50-60	
(B) 8TC0100C	M16 X 2 X 55 S.H.	10.9	(B) ROTOR CASING-INLET CASING & OUTLET CASING MOTOR CASING-INLET CASING OPEN DRIVE END COVER-INLET CASING	183-197	135-145	
8TC0101C	M20 X 2.5 X 70 S.H.	10.9	INLET FLANGES-INLET CASING	352-380	260-280	
SET SCREW PART NO.	SET SCREW SIZE & TYPE (mm)		USAGE			
(B) 8TC0373C	M10 X 1.5 X 16 S.S.	10.9	OPEN DRIVE SEAL ADAPTER	41-47	30-35	
8TC0089C	M10 X 1.5 X 30 S.S.	10.9	(B) STATOR KEY LOCK	41-47	30-35	
PIPE PLUG PART NO.	PIPE PLUGS (AMERICAN)		LOCATION			
8TC0142C	1/8 NPTF		INLET CASING	20-27	15-20	180-240
8TC0290C	1/4 NPTF		SLIDE CASING	27-34	20-25	240-300
HEX PLUG PART NO.	HEX PLUG (AMERICAN)					
8TC0106C	7/16-20	(B)	INLET CASING, SLIDE CASING	13-16	10-12	130-140
8TC0107C	9/16-18		MOTOR CASING, OUTLET CASING, ROTOR CASING, SLIDE CASING	23-26	17-19	210-230
8TC0108C	3/4-16	(B)	OUTLET CASING	60-65	44-48	530-570
8TC0109C	1 1/16-12		INLET CASING, ROTOR CASING, OUTLET CASING	112-125	83-92	1000-1100
TERMINAL PIN PART NO.	TERMINAL PIN (AMERICAN)					
(B) 02XB35008801	1 3/16-12		MOTOR CASING	135-147	100-108	
LOCKNUT PART NO.	LOCKNUT SIZE (mm)		USAGE			
8TC0047C	M20 X 1		SLIDE VALVE ASSY	68-75	50-55	
8TC0048C	M35 X 1.5		SLIDE VALVE ASSY	95-102	70-75	
RELIEF VALVE PART NO.	THREAD SIZE (AMERICAN)		LOCATION			
(B) 8TC0287C	1-5/8-12 UN-2A		ROTOR CASING	345-379	254-279	
PLUG, ORIFICE PART NO.	THREAD SIZE (mm)					
1TC0044C	M8 X 1.25		INLET CASING	19-24	14-18	168-216
1TC0052C	M8 X 1.25		INLET CASING, OPEN DRIVE END COVER (B)	19-24	14-18	168-216

* Nm = Newton-meters



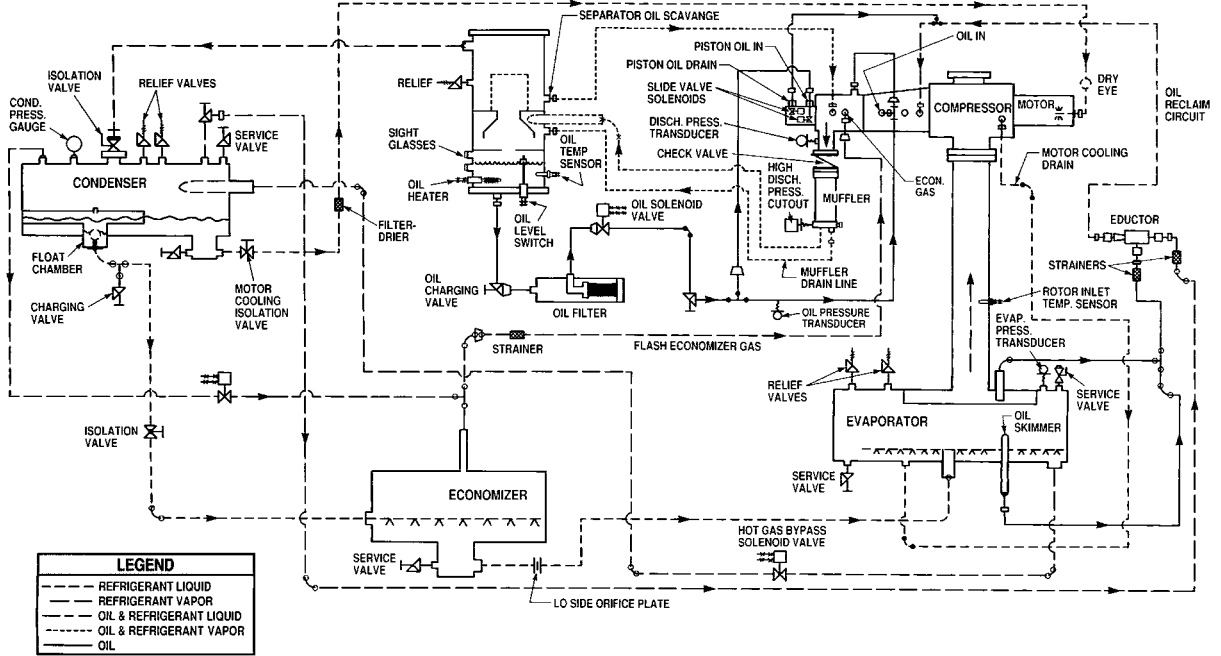

Refrigerant - Oil Flow Schematic

