

## Hermetic Centrifugal Liquid Chillers

### SAFETY CONSIDERATIONS

Centrifugal liquid chillers are designed to provide safe and reliable service when operated within design specifications. When operating this equipment use good judgment and safety precautions to avoid damage to equipment and property or injury to personnel.

Be sure you understand and follow the procedures and safety precautions contained in the machine instructions as well as those listed in this guide.

#### ▲ DANGER

DO NOT USE OXYGEN to purge lines or to pressurize a machine for any purpose. Oxygen gas reacts violently with oil, grease and other common substances.

NEVER EXCEED specified test pressures. VERIFY the allowable test pressure by checking the instruction literature and the design pressures on the equipment nameplate.

DO NOT VALVE OFF any safety device.

BE SURE that all pressure relief devices are properly installed and functioning before operating any machine.

#### ▲ WARNING

DO NOT WELD OR FLAME CUT any refrigerant line or vessel until all refrigerant (*liquid and vapor*) has been removed from chiller. Traces of vapor should be displaced with dry air or nitrogen and the work area should be well ventilated. *Refrigerant in contact with an open flame produces toxic gases.*

DO NOT USE eyebolts or eyebolt holes to rig machine sections or the entire assembly

DO NOT work on high-voltage equipment unless you are a qualified electrician.

DO NOT WORK ON electrical components, including control panels, switches, starters or oil heater until you are sure ALL POWER IS OFF and no residual voltage can leak from capacitors or solid-state components.

LOCK OPEN AND TAG electrical circuits during servicing. IF WORK IS INTERRUPTED, confirm that all circuits are de-energized before resuming work.

DO NOT syphon refrigerant by mouth.

AVOID SPILLING liquid refrigerant on skin or getting it into the eyes. USE SAFETY GOGGLES. Wash any spills from the skin with soap and water. If any enters the eyes, IMMEDIATELY FLUSH EYES with water and consult a physician.

NEVER APPLY an open flame or live steam to a refrigerant cylinder. Dangerous overpressure can result. When necessary to heat refrigerant, use only warm (110 F/43 C) water.

DO NOT REUSE disposable (nonreturnable) cylinders nor attempt to refill them. It is DANGEROUS AND ILLEGAL. When cylinder is emptied, evacuate remaining gas pressure, loosen the collar and unscrew and discard the valve stem. DO NOT INCINERATE.

CHECK THE REFRIGERANT TYPE before charging

machine. High-pressure refrigerant in a low-pressure machine can cause vessels to rupture if the relief devices cannot handle the refrigerant volume.

DO NOT ATTEMPT TO REMOVE fittings, covers, etc. while machine is under pressure or while machine is running. Be sure pressure is at zero psig before breaking any refrigerant connection.

CAREFULLY INSPECT all relief valves, rupture discs and other relief devices AT LEAST ONCE A YEAR. If machine operates in a corrosive atmosphere, inspect the devices at more frequent intervals.

DO NOT ATTEMPT TO REPAIR OR RECONDITION any relief valve when corrosion or build-up of foreign material (rust, dirt, scale, etc.) is found within the valve body or mechanism. Replace the valve.

DO NOT VENT refrigerant relief valves within a building; refer to ANSI/ASHRAE 15-1978. The accumulation of refrigerant in an enclosed space can displace oxygen and cause asphyxiation.

DO NOT install relief valves in series or backwards.

USE CARE when working near or in line with a compressed spring. Sudden release of the spring can cause it and objects in its path to act as projectiles.

#### ▲ CAUTION

DO NOT STEP on refrigerant lines. Broken lines can whip about and cause personal injury.

DO NOT climb over a machine. Use platform, catwalk or staging. Follow safe practices when using ladders.

USE MECHANICAL EQUIPMENT (crane, hoist, etc.) to lift or move inspection covers or other heavy components. Even if components are light, use such equipment when there is a risk of slipping or losing your balance.

BE AWARE that certain automatic start arrangements CAN ENGAGE THE STARTER. Open the disconnect ahead of the starter in addition to shutting off the machine or pump.

USE only repair or replacement parts that meet the code requirements of the original equipment.

DO NOT VENT OR DRAIN water boxes containing industrial brines, liquid, gases or semisolids without permission of your Process Control Group.

DO NOT LOOSEN water box cover bolts until the water box has been completely drained.

DOUBLE-CHECK that coupling nut wrenches, dial indicators or other items have been removed before rotating any shafts.

DO NOT LOOSEN a packing gland nut before checking that the nut has a positive thread engagement.

PERIODICALLY INSPECT all valves, fittings and piping for corrosion, rust, leaks or damage.

PROVIDE A DRAIN connection in the vent line near each pressure relief device to prevent a build-up of condensate or rain water.

## CONTENTS

	Page		Page
<b>SAFETY CONSIDERATIONS</b> .....	1	<b>Removing Refrigerant</b> .....	16
<b>INTRODUCTION</b> .....	5	<b>Trimming Refrigerant Charge</b> .....	16
<b>BEFORE INITIAL START-UP</b> .....	5-8	<b>Refrigerant Loss</b> .....	16
Job Data Required .....	5	<b>Air and Water Leaks</b> .....	16
Equipment Required .....	5	<b>Pressurizing the Machine</b> .....	16
Check Machine Tightness .....	6	<b>Guide Vane Linkage</b> .....	17
Inspect Piping .....	6	<b>TROUBLESHOOTING GUIDE</b> .....	18-22
Charge Refrigerant .....	6	Compressor Will Not Start .....	18
Inspect Wiring .....	7	Compressor Trips Off .....	19
Check Starter .....	7	Compressor Runs But Guide Vanes Will Not Open .....	20
Oil Charge .....	7	Chilled Water Temperature Too High ....	21
Check Oil Heater .....	8	Chilled Water Temperature Too Low ....	21
Check Safety Control Operation .....	8	Chilled Water Temperature Fluctuates, Vanes Hunt .....	20
Check Purge Operation .....	8	Oil Reservoir Temperature Too Low ....	20,21
<b>INITIAL START-UP</b> .....	8-11	Oil Reservoir Temperature Too High ...	21
Prepare Machine for Initial Start-Up ....	8	Purge Does Not Operate in AUTO. Position .....	21
Initial Start-Up .....	8	Purge Cycles Often in AUTO. Position ..	22
Set Safety Controls (Initial Start-Up)....	9	Excessive Refrigerant Loss .....	22
Check Operating Controls .....	9	<b>GENERAL DATA</b> .....	23
Check Machine Operating Condition ....	11	Machine Informative Plate .....	23
Trim Refrigerant Charge .....	11	System Components .....	23
<b>OPERATING INSTRUCTIONS</b> .....	12-13	<b>REFRIGERATION CYCLE</b> .....	23,24
Operator Duties .....	12	<b>MOTOR COOLING CYCLE</b> .....	24
Prepare Machine for Start-Up .....	12	<b>LUBRICATION CYCLE</b> .....	24,25
Start Machine .....	12	Summary .....	24
Check Running System .....	12	Details .....	24
To Stop Machine .....	12	<b>PURGE CYCLE</b> .....	25,26
After Limited Shutdown .....	12	Purge Operation .....	26
Extended Shutdown .....	12	<b>CONTROLS</b> .....	27-29
After Extended Shutdown .....	12	Description .....	27
Manual Operation .....	13	Program Timer .....	27
Refrigeration Log .....	13	Oil Heater and Thermostat .....	27
<b>WEEKLY MAINTENANCE</b> .....	13	Machine Control Wiring .....	27
Check Lubrication System .....	13	Typical Control Sequence — Machine Start .....	27
Check Purge Operation .....	13	Typical Control Sequence — Machine Stop .....	28
<b>SCHEDULED MAINTENANCE</b> .....	13-15	Typical Control Sequence — Machine Recycle .....	29
Inspect Control Center .....	13	<b>CONTROL OPTIONS</b> .....	30,31
Check Safety Controls .....	13	General .....	30
Change Oil and Oil Filter .....	14	Remote Thermostat .....	30
Change Refrigerant Filter and Volute Drain Filter .....	14	Lead-Lag Control .....	30
Compressor Bearing Maintenance .....	14	Safety Indicator Panel .....	30
Inspect Purge .....	14	Autostart Control .....	30
Inspect Refrigerant Flow Chamber .....	15	<b>INSTRUCTING THE OPERATOR</b> .....	31,32
Inspect Unishell Tubes .....	15		
Inspect Starting Equipment .....	15		
Ordering Replacement Parts .....	15		
<b>GENERAL MAINTENANCE</b> .....	16-17		
Refrigerant Properties .....	16		
Charging Refrigerant .....	16		

NOTE: Dual measurement notations shown are for English and SI metric units respectively. When vacuum readings are expressed as gage or absolute in English units, the corresponding metric units are expressed the same way.

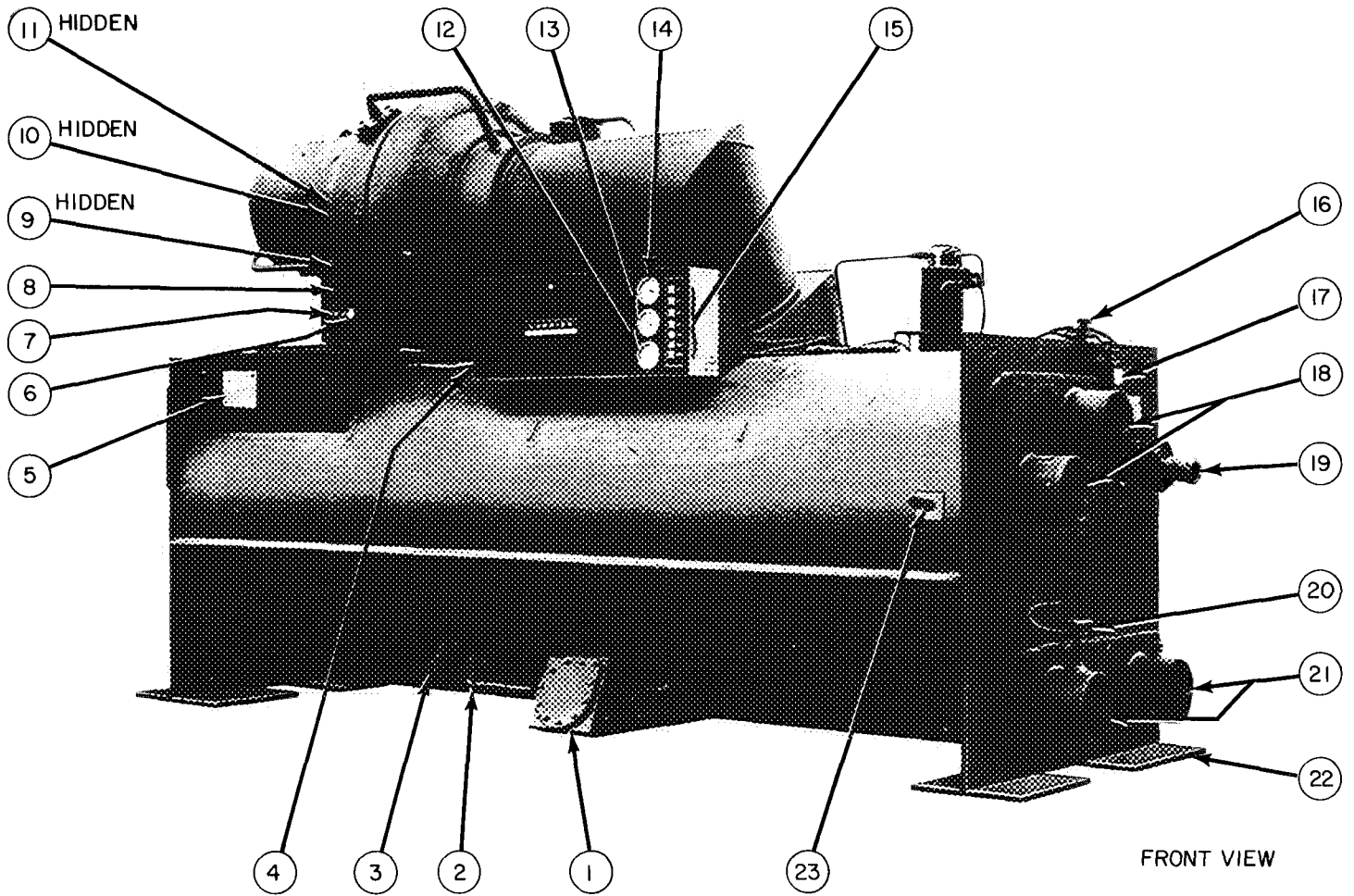

- |  |  |  |
|--|--|--|
| 1 — Flow Valve Chamber                     | 9 — Oil Reservoir Pressure Gage (Hidden)   | 17 — Chilled Water Low-Temperature Cutout and Recycle Switch |
| 2 — Cooler Charging Valve                  | 10 — Return-Oil Temperature Gage (Hidden)  | 18 — Condenser Water Nozzles                                 |
| 3 — Refrigerant Level Sight Glasses        | 11 — Compressor Nameplate (Hidden)         | 19 — Safety Relief Device                                    |
| 4 — Field Wiring Knockouts                 | 12 — Cooler Pressure Gage                  | 20 — Chilled Water Control Sensor                            |
| 5 — Machine Informative Plate              | 13 — Condenser Pressure Gage               | 21 — Cooler Water Nozzles                                    |
| 6 — Oil Reservoir Temperature Gage         | 14 — Oil Pump Differential Pressure Gage   | 22 — Support Plates  |
| 7 — Oil Heater and Thermostat Terminal Box | 15 — Control Buttons and Indicating Lights | 23 — Condenser Temperature Thermowell                        |
| 8 — Oil Level Sight Glass                  | 16 — Purge Valve No. 3                     |  |

24-49 — Shown on page 4.

**Fig. 1 — 19DK Machine Components**

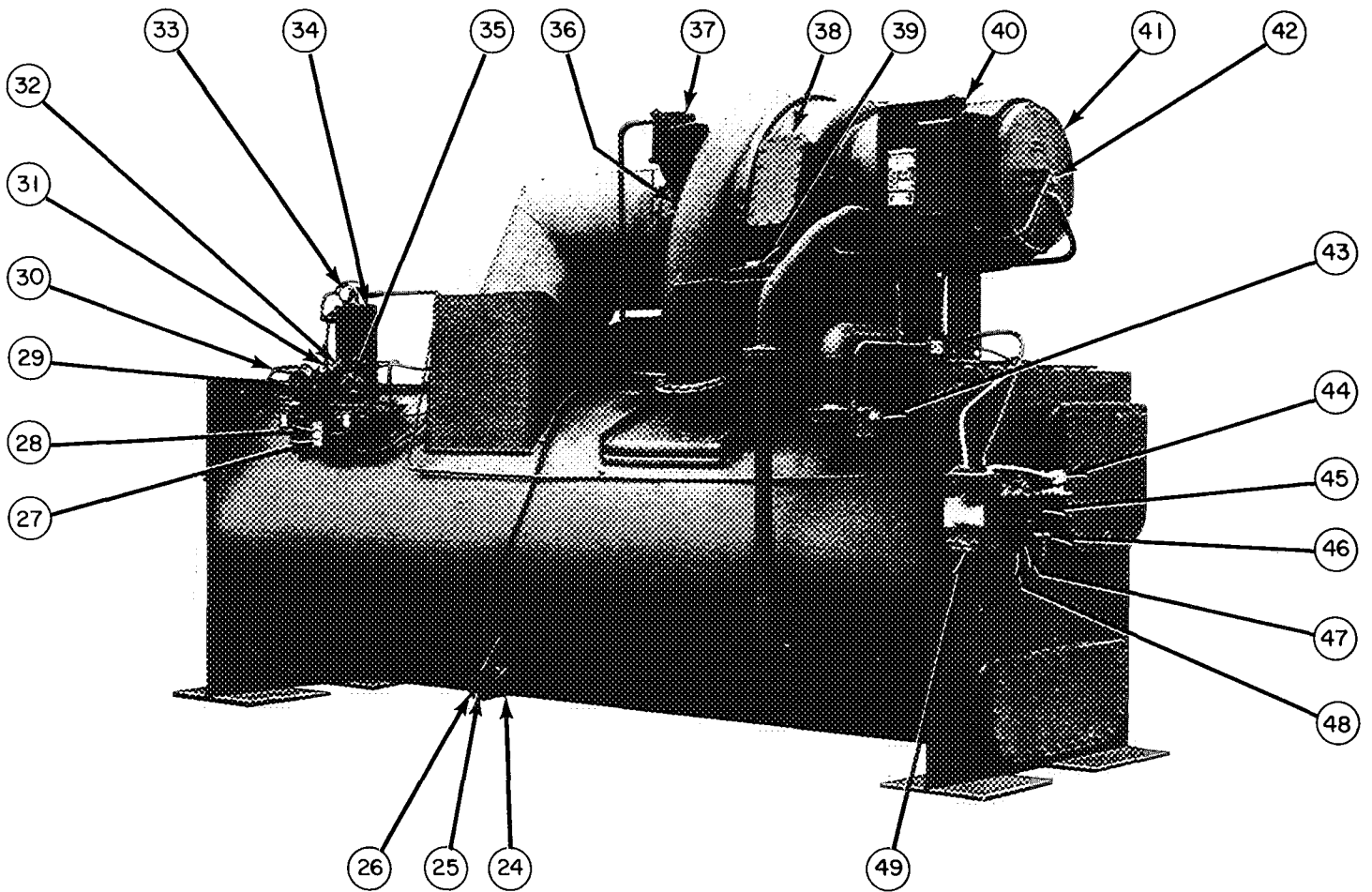

- |   |   |  |
|---|---|--|
| 24 — Refrigerant Low-Temperature Cutout | 33 — Purge Pressure Gage                  | 42 — Motor Rotation Sight Glass                  |
| 25 — Low-Temperature Cutout Element     | 34 — Purge Condensing Chamber             | 43 — Refrigerant Filter                          |
| 26 — Refrigerant Thermowell             | 35 — Refrigerant Sight Glass              | 44 — Oil Cooler Solenoid Valve and Plug Valve    |
| 27 — Purge Pump Switch                  | 36 — Vane Seal Oiler                      | 45 — Oil Pump, Cooler and Filter Assembly        |
| 28 — Purge Solenoid Switch              | 37 — Guide Vane Actuator                  | 46 — Oil Cooler Drain Plug                       |
| 29 — Purge Pump                         | 38 — Compressor Access Plate              | 47 — Oil Charging Valve                          |
| 30 — Purge Valve No 2                   | 39 — Inlet Volute Drain Filter            | 48 — Oil Pressure Regulating Valve (Factory Set) |
| 31 — Water Drain Valve                  | 40 — Compressor Terminal Box (less cover) | 49 — Oil Pump Starter, Factory Installed         |
| 32 — Water Level Sight Glass            | 41 — Motor End Cover                      |  |

**Fig. 1 — 19DK Machine Components (cont)**

## INTRODUCTION

Initial Start-Up Procedure . . . . . Pages 5 to 11  
Operation and Maintenance . . . . . Pages 12 to 17

**General** — The 19DK is factory assembled, wired and tested. Installation (not by Carrier) consists primarily of establishing water and electrical services to the machine. The contractor and/or customer perform rigging, installation, field wiring and field piping.

Carrier provides necessary labor for pressure testing refrigerant side, initial refrigerant charging, checking and setting controls, initial start-up and review of operating instructions with owner's representative on a one-trip, straight time basis.

All persons involved in the start-up and maintenance of the 19DK machine should be thoroughly familiar with these instructions, machine components, and other necessary job data before initial

start-up. Figure 1 shows machine components. Procedures in this book are arranged in the sequence required for proper machine operation.

## BEFORE INITIAL START-UP

### Job Data Required

1. List of applicable design temperatures and pressures.
2. Machine assembly, wiring and piping prints.
3. Starter details and wiring diagrams.
4. Prints and instructions for special controls.
5. 19DK Installation Instructions.

### Equipment Required

1. Mechanic's tools.
2. Volt-ohmmeter and clamp-on ammeter.
3. Leak detector, electronic or halide.
4. Absolute pressure manometer.

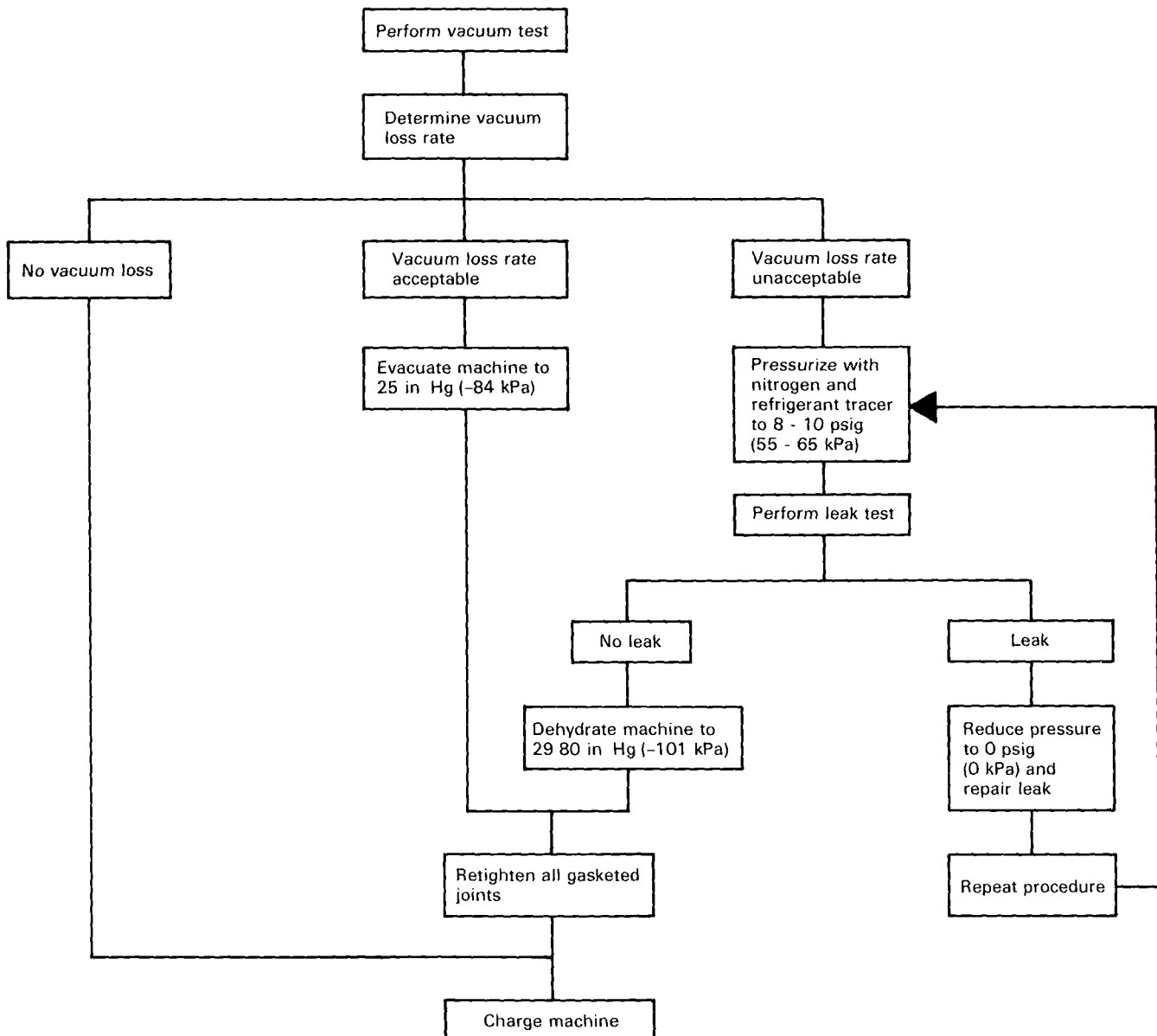

Fig. 2 — 19DK Leak Test Sequence and Procedures

5. Refrigerant drum charging valve.
6. 5/8-in. SAE x 3/4-in. MPT adapter.
7. Five to 10ft (1.5 to 3m) of copper tubing or plastic hose to fit 5/8-in. SAE connections.

**Check Machine Tightness** — Figure 2 outlines the proper sequence and procedures for leak testing.

19DK machines are shipped under refrigerant-side vacuum. Over a period of time, during shipment or storage, part of this vacuum may be lost. Perform vacuum test to determine whether the vacuum loss, if any, is within Carrier's machine tightness standards.

#### VACUUM TEST

1. Check machine for open valve or other open connection. Correct before proceeding.
2. Install absolute pressure manometer or wet bulb indicator at cooler charging valve. A dial gage cannot indicate the small amount of leakage acceptable.
3. Pull a vacuum of 25 in. Hg (-84 kPa) ref 30-in. bar. (2.5 psia) (17 kPa). Use external vacuum pump or purge pump (see purge valve operation chart, Fig. 12).
4. Let machine stand with vacuum for 24 hours or more. Then determine vacuum loss rate by this formula:

$$\text{Vacuum loss rate} = \frac{\text{vacuum difference}}{\text{no. days between readings}}$$

5. If loss rate is 0.05 in. Hg (.17 kPa) or less in 24 hours, machine is sufficiently tight. Perform Machine Dehydration.
6. If loss rate exceeds 0.05 in. Hg (.17 kPa) in 24 hours, make Refrigerant Pressure Test, repair leaks and then dehydrate machine.

#### REFRIGERANT PRESSURE TEST

1. Pull a vacuum of 5.0 in. Hg (-17.0 kPa) ref 30-in. bar. (12.5 psia) (86 kPa), using Operation 2 on the purge valve operation chart (Fig. 12). An external vacuum pump, attached to cooler charging valve (item 2, Fig. 1), may be used if desired.
2. Charge approximately one gallon (3.8 L) of Refrigerant 11 thru the cooler charging valve. See Charge Refrigerant for procedure.
3. Raise machine pressure to 8 - 10 psig (55 - 69 kPa) with dry air or nitrogen. Procedure is described under Pressurizing the Machine, page 16. *Do not exceed 10 psig (69 kPa).*
4. Test all valves, joints, fittings, etc. with a halide or electronic leak detector.
5. Reduce machine pressure to near 0 psig (0 kPa); repair any leaks and then retest to ensure repair. *Retighten all gasketed joints after leak testing.*

**MACHINE DEHYDRATION** — The refrigerant side of the 19DK machine is dehydrated at the factory. If the machine has been open for a considerable period of time due to compressor removal,

or if there has been excessive loss of shipping vacuum, dehydration should be repeated.

Dehydration is readily accomplished at normal or high room temperature. At low room temperature, special techniques must be employed; contact your field service representative.

#### ▲ CAUTION

Do not start compressor, oil pump or purge motor even for a rotation check, nor apply test voltage of any kind while machine is under dehydration vacuum. Motor insulation breakdown and serious damage can result.

1. Connect dehydration pump to cooler charging valve.
2. Close all valves on purge assembly. Valves are identified on purge valve operation chart (Fig. 12).
3. Connect an absolute pressure manometer to purge connection A (Fig. 10).
4. Operate dehydration pump until a vacuum of 29.80 in. Hg (-101 kPa) ref 30-in. bar. (0.1 psia) (0.7 kPa) is reached. Continue to operate pump for 2 more hours.
5. Close cooler charging valve; stop dehydration pump; record manometer reading.
6. After a 2-hour wait, read manometer again. If vacuum has not decreased, dehydration is complete. If vacuum has decreased, repeat steps 4, 5 and 6.
7. If vacuum fails to hold after several dehydration attempts, check for a machine leak by repeating Refrigerant Pressure Test. After repairing leak, repeat Vacuum Test and Machine Dehydration.

**Inspect Piping** — Refer to piping diagrams provided in Job Data and inspect piping to cooler, condenser and oil cooler. Be sure that flow directions are correct and that all piping specifications are met.

Piping systems must be properly vented, with no stress on water box nozzles or covers.

Water flow thru cooler and condenser must meet job requirements. Measure pressure drop across cooler and condenser or across pumps.

Oil cooler water and piping must meet the specifications set forth in Job Data and in 19DK Installation Instructions. If city water is used, make sure that drainage is visible. Adjustment of plug valve (item 44, Fig. 1), to provide proper bearing temperature, is made after compressor start.

**Charge Refrigerant** — Refrigerant supplied with the machine is more than that required for initial charging. Refer to Table 3, page 32, for correct amount of charge. Machine vacuum will draw refrigerant from drum.

After machine has been started, adjust charge as required for optimum machine performance. Refer to Trim Refrigerant Charge, page 11.

1. Connect short piece of plastic hose or copper tubing from refrigerant drum valve to cooler charging valve (item 2, Fig. 1).
2. Circulate chilled water during the charging process.
3. Charge refrigerant as a gas from the upright refrigerant drum until cooler vacuum becomes less than 18 in. Hg (-61 kPa); (6 psia) (41 kPa).

#### ▲ CAUTION

At a vacuum of 18 in. Hg (-61 kPa) or greater, liquid Refrigerant 11 flashes into gas and can cause tube freeze-up and extensive damage.

4. Be sure that oil heater (item 7, Fig. 1) is energized during the charging process.

### Inspect Wiring

#### ▲ WARNING

Do not check high-voltage supply without proper equipment and precautions. Serious injury may result. Follow power company recommendations.

1. Examine wiring for conformance to job wiring diagrams and applicable electrical codes.
2. Check nameplates of oil pump, oil heater, and machine control panel for agreement with supply voltage, phase and Hertz.
3. Check motor starter ratings against motor voltage and amperage requirements. Motor overload relay selection must satisfy electrical code requirements.
4. Starter for centrifugal compressor motor must contain the components and terminals required for refrigeration machine control. Check job drawings.
5. Check that fused disconnects have been supplied for oil pump and oil heater.
6. Check that electrical equipment and controls are properly grounded in accordance with applicable electrical codes.
7. Make sure customer/contractor has verified proper operation of water pumps, cooling tower fan and associated auxiliary equipment. This includes ensuring that motors are properly lubricated and have proper electrical supply and proper rotation.
8. Test machine compressor motor and its power lead insulation resistance with a 500-volt insulation tester such as a megohmmeter.

Do not apply test voltage of any kind while compressor is under dehydration vacuum.

- a. *Open starter main disconnect switch.*
- b. With tester connected to the motor side of the starter contactor in the starter, take 10-second and 60-second megohm readings as follows:  
Six-lead motor — Tie all 6 terminals together and test between terminal group and ground. Next tie terminals in pairs, 1 and 4, 2 and 5, 3 and 6. Test between each pair while grounding the third pair.  
Three-lead motor — Tie terminals 1, 2 and 3 together and test between group and ground.
- c. Divide the 60-second resistance reading by the 10-second reading. The ratio (or polarization index) must be 1.15 to 1 or higher. Both the 10-second and 60-second reading must be at least 50 megohms. If the readings are unsatisfactory, repeat the test at the motor terminals with the power leads disconnected. Satisfactory readings in this second test indicate that the fault is in the power leads.

#### ▲ CAUTION

BE AWARE that certain automatic start arrangements can engage the starter. Open the disconnect ahead of the starter in addition to shutting off the machine or pump.

### Check Starter

1. Remove contactor arc chutes. Be sure that contactors move freely and that shipping string has been removed. Replace arc chutes.
2. Check contactors for dirt and rust. Clean contact magnet surfaces lightly with sandpaper. *Do not sandpaper or file silverplated contacts.* Apply a very thin coat of petroleum jelly to magnet surfaces and then wipe it off. If starter has been in a dusty atmosphere, vacuum clean cabinet and wipe with lint-free cloth.
3. Remove fluid cups from magnetic overload relays. Add dashpot oil to cups per instructions on relay nameplate. Oil is usually shipped in small vials attached to starter frame near relays. Use only dashpot oil supplied with starter. *Do not substitute.* Overload relays are factory set at 108% of motor full load amperage.
4. Check transfer timer for proper setting. On reduced voltage starters, timer has an adjustable range up to one minute and is factory set at 30 seconds.
5. With main disconnect open, manually open and close main control relay 1CR to be sure that it operates freely.

**Oil Charge** — The oil charge of approximately 15 gallons (57 L) is shipped in the oil reservoir. Oil level should be visible at about 1/2 sight glass. If oil is added, it must meet Carrier specifications for hermetic centrifugal compressor usage.

Charge oil thru the oil reservoir charging valve (item 47, Fig. 1). With machine at vacuum, oil is drawn from the oil container. Continue charging until oil reaches middle of sight glass.

**Check Oil Heater** — Energize the oil heater (item 7, Fig. 1) to minimize absorption of refrigerant by the oil. An indicator light goes on when the oil heater is energized. The oil heater thermostat has been factory set to maintain 140 - 145 F (60 - 63 C) temperature at machine shutdown. Adjust if required.

**Check Safety Control Operation** — As the following checks are made, control panel lights should appear as indicated.

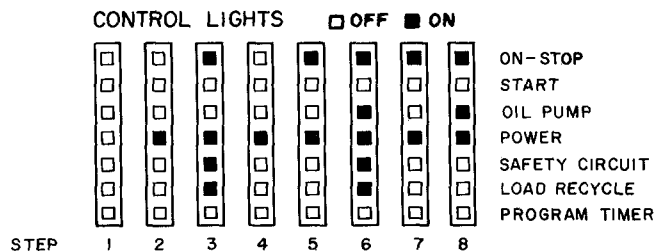

1. Open main disconnect (all power off to starter and controls). Then disconnect main motor leads in starter.
2. Provide control circuit power.
3. Press ON-STOP button (light goes on). If SAFETY CIRCUIT light does not go on, check resets on condenser high-pressure safety, low refrigerant safety, and compressor overloads in starter. Check 3-amp fuse in control center.

If SAFETY CIRCUIT light goes on but LOAD RECYCLE light stays off, check the chilled water recycle switch (AUTO.-RESET).

If both lights go on, manually trip and reset compressor motor overloads in starter, low-refrigerant temperature safety and condenser high-pressure safety. Tripping the chilled water recycle switch will cut off the LOAD RECYCLE light only.

4. Press ON-STOP button (light goes out). Remove and tag brown wire running between terminal 17 and 17 in control center.
5. Start chilled water and condenser water pumps. Press ON-STOP button (light goes on).
6. Press OIL PUMP button for several seconds. Pump should raise oil pressure to 20 - 25 psi (138 - 172 kPa) differential between pump discharge gage on control panel and oil reservoir gage. SAFETY CIRCUIT and LOAD RECYCLE lights should go on.
7. Release OIL PUMP button. SAFETY CIRCUIT and LOAD RECYCLE lights should go out.
8. With OIL PUMP button depressed, alternately stop and restart chilled water and condenser water pumps. SAFETY CIRCUIT and LOAD

RECYCLE lights should go out as each pump stops.

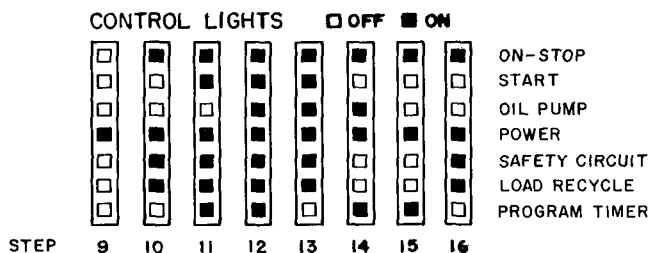

9. Shut off water pumps. Release OIL PUMP button. Press ON-STOP button (light goes out). Replace tagged wire on terminal 17.
10. Press ON-STOP button (light goes on).
11. Press machine START button (motor leads disconnected).
12. Oil pump starts within 30 seconds.
13. Compressor motor start contacts close 30 seconds later. Starter transfers to run condition 30 to 60 seconds after starter is energized.
14. Open oil pump disconnect. Compressor motor starter must de-energize. OIL PUMP light will remain on for about 30 seconds.
15. OIL PUMP light goes out.
16. Close oil pump disconnect. In approximately 15 minutes, the program timer will complete the anti-recycle portion of its cycle and the machine is ready to restart.
17. Remove all power and then reconnect motor leads. Restore power.

**Check Purge Operation** — Place purge operating valves (Fig. 10) in NORMAL AUTOMATIC position. Operate the purge pump momentarily by placing purge switch in MANUAL position. Then place purge switch again in NORMAL AUTOMATIC position.

## INITIAL START-UP

**Prepare Machine for Initial Start-Up** — Follow all steps described in Operating Instructions section under Prepare Machine for Start-Up, page 12.

**Initial Start-Up** — Before operating machine for any length of time, check compressor rotation and operation as follows:

Set the capacity control switch (item 19, Fig. 3) at the HOLD position.

Follow the Start machine procedures on page 12. As the compressor motor shaft begins to turn, check for clockwise rotation thru motor end bell sight glass. Let compressor come up to speed and note oil differential pressure on control center gage; differential should be 20 - 25 psi (138 - 172 kPa).

Press machine ON-STOP button after compressor has reached operating speed. Listen for any unusual sounds from compressor as it coasts to a stop. Confirm clockwise rotation as compressor coasts to a stop.

If rotation is not clockwise, correct the condition. Electric motor rotation can be reversed by reversing any 2 of the 3 power leads entering the starter. Recheck rotation after taking corrective action.

The program timer (item 3, Fig. 3) prevents rapid recycling of the compressor and allows restart 15 minutes after stop.

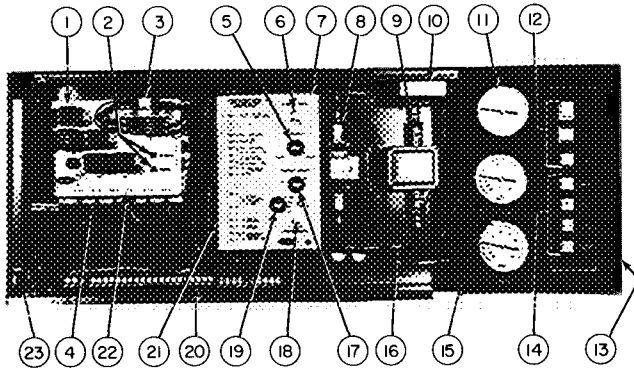

- |  |   |
|--|---|
| 1 — Control Relays: K1, K2, K3, KB and KM          | 12 — Push Button with Indicating Light  |
| 2 — Motor and Bearing Safety Indicator Lights      | 13 — Elapsed Time Indicator             |
| 3 — Program Timer                                  | 14 — Indicating Lights                  |
| 4 — Factory Wiring Terminal Strip                  | 15 — Refrigerant Pressure Gages         |
| 5 — Chilled Water Thermostat                       | 16 — Opening for Refrigerant Tubing     |
| 6 — Throttle Range Adjustment                      | 17 — Electrical Demand Control          |
| 7 — Capacity Control Module                        | 18 — Motor Current Calibration          |
| 8 — Oil Low-Pressure Cutout                        | 19 — Capacity Control Switch            |
| 9 — Vane-Close Oil Pressure Switch                 | 20 — Field Wiring Terminal Strips       |
| 10 — Condenser High-Pressure Cutout (manual reset) | 21 — Factory Wiring Terminal Strip      |
| 11 — Oil Pump Differential Pressure Gage           | 22 — Relay Module                       |
|  | 23 — Knockouts for Field Control Wiring |

**Fig. 3 — Machine Control Center**

**Set Safety Controls (Initial Start-Up)**

**▲ CAUTION**  
 While performing these checks, carefully monitor chilled water temperature to prevent freeze-up. Protection by safety controls cannot be assumed until all control settings have been confirmed.

Open main disconnect (all power off to starter and controls). Set capacity control switch at HOLD. Place clamp-on ammeter on one of the 3 starter leads. Install jumpers between terminals 41 and 43, and between 10 and 11 (per wiring label in control center).

Close disconnect(s), start compressor and check oil temperature and pressure (140 - 150 F) (60 - 66 C)

and 20-25 psid (138 - 172 kPa). With compressor running, manually operate guide vanes with capacity control switch. *Do not exceed 100% of full load amperage.*

1. Set controls 1 and 2 as indicated in Table 1.
2. Stop machine; open disconnect(s); remove jumpers and check settings of controls 3, 4, 5 and 6 as indicated in Table 1.

**Check Operating Controls** — Check guide vane linkage as described under Guide Vane Linkage, page 17.

**CALIBRATE MOTOR CURRENT**

1. Establish a steady motor current value for this calibration. Open guide vanes manually (capacity control at INC.) until full load current is reached. Motor current calibration (item 18, Fig. 3) may have to be turned counterclockwise to permit vanes to open as needed. *Do not exceed 105% of nameplate full load amperes.*

If full load current can be maintained for a period of time, calibrate at this condition. If not, pull down to and maintain (capacity control at HOLD) design leaving chilled water temperature, and calibrate at this condition.

2. Measure motor current at selected condition and determine its percentage of full load current.
3. Use this percentage to set the electrical demand control (item 17, Fig. 3) as follows:

PERCENT OF FULL LOAD MOTOR CURRENT	ELECTRICAL DEMAND ADJUSTMENT SETTING
105	100%
85 or above	80%
65 to 84	60%
45 to 64	40%
below 45	Control cannot be calibrated

4. Turn motor current calibration adjustment fully clockwise. Guide vanes will close part way.
5. Turn thermostat (item 5, Fig. 3) to COOLER (fully counterclockwise).
6. Set capacity control at INC. position.
7. Slowly turn motor current calibration counterclockwise. Allow the guide vanes to open until motor current reaches 5% above electrical demand setting.

NOTE: When adjusting motor current calibration, allow for a time lag of several seconds caused by feedback capacitance in the motor current circuit.

8. Check the foregoing motor current calibrations with machine under AUTO. control as follows:
  - a. Close vanes manually (capacity control to DEC.).
  - b. Turn capacity control to AUTO. Vanes should stop opening at electrical demand setting.

## Table 1 — Setting Safety Controls

### SAFETY OR CONTROL DEVICE

#### 1. Chilled Water Low-Temperature Cutout and Recycle Switch SWITCH MAY BE TYPE SHOWN IN 1A OR 1B

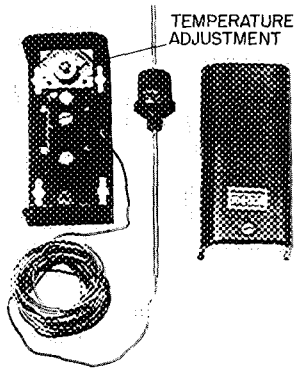

TYPE 1A

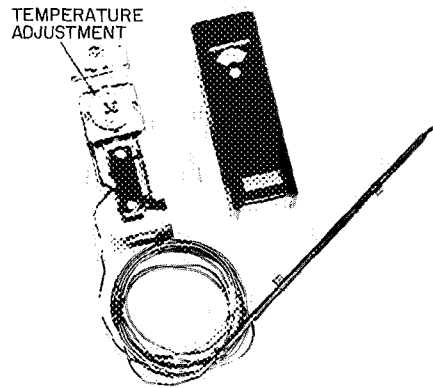

TYPE 1B

Switch shown in 1B has nonadjustable differential of 10 F (5.6 C).

1. With machine operating, adjust switch to open at approximately 5 F (2.8 C) below design chilled water temperature, or 36 F (2.2 C), whichever is higher.
2. If differential is adjustable, set at 10 F  $\pm$  1 F (5.6  $\pm$  0.5 C) so that when machine shuts down automatically at set point

- chosen in step 1, it will restart automatically on water temperature rise of 10 F (5.6 C) above the set point
- 3 This switch must open ahead of the cooler low refrigerant temperature cutout in order for the machine to recycle automatically

#### 2. Refrigerant Low-Temperature Cutout CUTOUT MAY BE TYPE SHOWN IN 2A or 2B

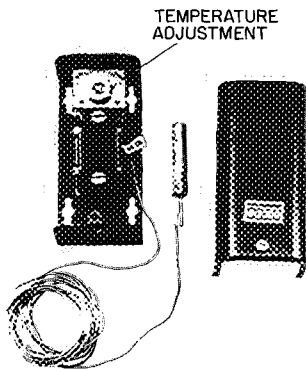

TYPE 2A

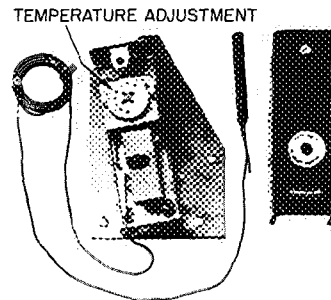

TYPE 2B

Set refrigerant low-temperature cutout at 33 F (0.5 C) or 1°F (0.5 C) below design refrigerant temperature, whichever is lower, while checking temperature at thermowell near switch

#### 3. Condenser High-Pressure Cutout

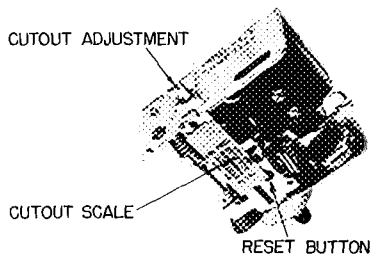

The condenser high-pressure cutout is factory set to shut machine down when condenser pressure reaches approximately 15 psig (103 kPa). Isolate the switch and check setting with a metered supply of air

#### 4. Oil Heater Thermostat

STOP MACHINE, REMOVE JUMPERS AND CHECK CONTROLS 3, 4, 5 AND 6

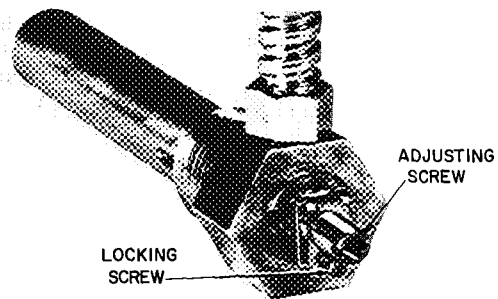

Set the oil heater thermostat to maintain a minimum oil reservoir temperature of 140 F (60 C) at shutdown. Turn screw counter-clockwise to raise set point

**Table 1 — Setting Safety Controls (cont)**

**SAFETY OR CONTROL DEVICE**

**5. Oil Low-Pressure Cutout**

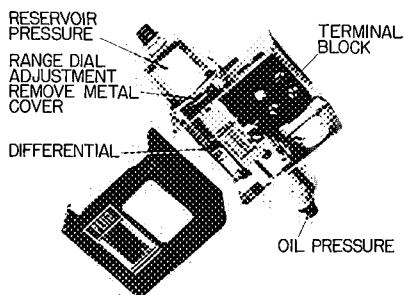

Oil low differential pressure switch is factory set to open at  $9.5 \pm 1$  psi ( $66 \pm 6.9$  kPa) and close at  $14.5 \pm 1$  psi ( $100 \pm 6.9$  kPa) differential pressure. Confirm settings with a regulated supply of air.

**6. Vane-Close Oil Pressure Switch**

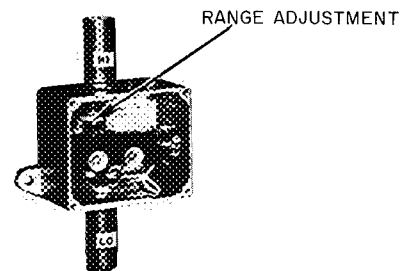

Vane-close oil pressure switch is factory set to close at  $18.5 (+1, -0)$  psi ( $128 [+6.9, -0]$  kPa) differential pressure (on rise), and open on a  $0.5$  psi ( $3.5$  kPa) drop in differential pressure. Switch does not require field calibration.

9. If control was calibrated at less than 100% load, turn electrical demand control to 100%. Control is now automatically calibrated for 100% full load current.
10. If control cannot be calibrated with above procedure, check voltage signal from signal resistor in starter. At 100% full load current, voltage between terminals 23 and 24 inside control center must be  $0.5 \pm 0.1$  volts. If not in this range, check sizing of resistor in starter and current transformer.

Both excess motor current and chilled water temperatures below the thermostat set point will override the capacity control setting. If the capacity control knob is in the INC. position, the guide vanes will stop opening. At any other knob position, the vanes will close as needed.

The motor current limiting circuit operates in 2 steps.

At 100% full load motor current, the vanes will stop opening further. If the motor current should increase to 105% because of some change in load conditions, the vanes will close until the current is reduced to about 102%.

When the motor current drops to 98% or below, control again responds to chilled water temperature.

The electrical demand adjustment allows the operator to set the maximum current drawn by the

motor and thus minimize the electrical demand rate during off-season operation.

**CHILLED WATER TEMPERATURE CALIBRATION**

1. Turn throttle range adjustment (item 6, Fig. 3) fully clockwise.
2. Adjust chilled water thermostat (item 5, Fig. 3) until design chilled water temperature is maintained. Mark this position on thermostat. If capacity control guide vanes hunt, turn throttle range adjustment counterclockwise in small steps until hunting ceases. Chilled water thermostat may require resetting.

**Check Machine Operating Condition** — Be sure that machine temperatures, pressures, water flow, oil and refrigerant levels indicate that the system is functioning normally. Refer to Check Running System on next page.

**Trim Refrigerant Charge** — If it is necessary to adjust the refrigerant charge to obtain optimum machine performance, operate the machine at full load and add or remove refrigerant slowly until the difference between leaving chilled water temperature and the cooler refrigerant temperature reaches design conditions or becomes a minimum. Mark the shutdown refrigerant level near the sight glasses (item 3, Fig. 1).

# OPERATING INSTRUCTIONS

Cond leaving water temp Over 65 F (18.3 C)  
Cooler refrig temp 30 - 40 F (-1.1 to +4.4 C)  
(refer to selected design temp)

## Operator Duties

1. Become familiar with machine and accessories before operating equipment.
2. Prepare system for start-up; start and stop machine; place system in shutdown condition.
3. Maintain log of operating conditions.
4. Monitor and inspect equipment, and make routine adjustments.
5. Protect equipment from damage during shutdown.

**Prepare Machine for Start-Up** — Before starting machine, check that:

1. Power is on to main starter, oil pump starter, water pumps and tower fan, oil heater, and machine control circuit.
2. Cooling tower water is at proper level and temperature.
3. Machine is charged with refrigerant.
4. Oil is visible in reservoir sight glass.
5. Oil reservoir temperature is 140 - 150 F (60 - 66 C) (with heater energized).
6. Oil cooler plug valve (item 44, Fig. 1) is partially open.
7. Valves in chilled water and condenser water circuits are open and water is circulating properly. *Do not run water warmer than 100 F (37.8 C) thru cooler.* Refrigerant over-pressure may break rupture disc and result in loss of refrigerant charge.
8. Purge valves and switches are in NORMAL AUTOMATIC position.

## Start Machine

1. Press ON-STOP button on control center (ON-STOP, SAFETY CIRCUIT and LOAD RECYCLE lights go on).
2. Press START button (light goes on).

Oil pump starts within 1/2 minute. If PROGRAM TIMER light is on, oil pump will start within 15 minutes. Compressor starts approximately 30 seconds after oil pump; program timer stops (light goes out).

**Check Running System** — After compressor starts, the operator should observe the following indications of normal operation.

Oil reservoir temp	140 - 150 F (60 - 66 C)
Bearing oil return temp	150 - 175 F (66 - 79 C)
Oil level	1/2 sight glass
Oil pressure	20 - 25 psi (138 - 172 kPa) differential between pump discharge and oil reservoir
Oil cooler water	Visible at open drain 75 - 105 F (24 - 40.6 C) (refer to selected design temp)

Purge pressure Midway between cooler and condenser operating pressures

NOTE: The compressor may operate at full capacity for a short time during pulldown even though the building load is small. The electrical demand control (item 17, Fig. 3) can be adjusted to avoid a high demand charge for the short period of full capacity operation.

## To Stop Machine

1. Press ON-STOP button (ON-STOP, START, SAFETY CIRCUIT and LOAD RECYCLE lights go out; PROGRAM TIMER light goes on). Compressor motor de-energizes and begins to coast down.
2. Stop water pumps and tower fan, if not automatic.
3. Oil pump stops within 40 seconds.
4. Machine can be restarted about 14 minutes after oil pump stops.

*If machine fails to stop, close guide vanes manually by turning capacity control switch to DEC. (decrease), and pull main circuit breaker. Do not attempt to stop machine by opening an isolating knife switch. DO NOT RESTART machine until malfunction has been corrected.*

**After Limited Shutdown** — No special preparations should be necessary. Follow regular preliminary checks and starting procedures.

**Extended Shutdown** — Ordinarily, refrigerant charge may be kept in machine. If machine pressure cannot be kept below atmospheric, removal and storage of refrigerant is recommended. (See Removing Refrigerant, page 16.)

If freezing temperatures are liable to occur in machine area, drain chilled water, condenser water and oil cooler water circuits to avoid freeze-up. Clear oil cooler lines with air. Keep water box drains open.

If refrigerant is left in machine and water lines are not drained, check refrigerant level weekly. An increase in refrigerant level indicates a water leak. Locate and repair such leaks immediately.

Leave the oil charge in the machine with the oil heater (item 7, Fig. 1) energized to keep oil temperature at 140 - 145 F (60 - 63 C).

**After Extended Shutdown** — Close water box drains. If the refrigerant has been removed, recharge the machine as directed in Charging Refrigerant section. Observe freeze-up precautions while charging.

Carefully make all regular preliminary and running system checks. If compressor oil level appears abnormally high, oil may have absorbed refrigerant; raise oil thermostat setting (item 7, Fig. 1) to drive off any refrigerant.

**Manual Operation** — Manual control permits the operator to change the leaving chilled water temperature without altering the automatic temperature control settings. It is useful in checking control operation and safety cutout points, in overcooling the building prior to a heavy load, or in controlling the machine in an emergency.

Turn the capacity control switch (item 19, Fig. 3) to DEC. (decrease) to close guide vanes and lower capacity.

HOLD maintains guide vane position.

INC. (increase) opens guide vanes and increases capacity. Manual control is overridden by the thermostat set point.

**Refrigeration Log** — The Carrier log sheet for 19D Series machines provides a convenient check list for routine maintenance and forms a continuing record of machine performance. It is an aid in scheduling maintenance and in diagnosing machine problems.

The log sheet is available from Carrier in pads of 50 each. When ordering, specify by form number E-56A, found at the lower left corner of the log sheet.

## WEEKLY MAINTENANCE

**Check Lubrication System** — Mark oil level on reservoir sight glass (item 8, Fig. 1) and observe level each week while machine is shut down. Record date and amount of oil added. Added oil must meet Carrier specifications for centrifugal compressor usage.

To add oil while machine is under vacuum, attach a tube to the oil charging valve (item 47, Fig. 1) and place the other end in an oil container. Keep tube end submerged to prevent air from entering machine. With machine at vacuum, oil is drawn from the container. Charge until oil reaches middle of sight glass.

If machine pressure is above atmospheric, a small hand pump will be required for pumping the oil into the reservoir.

A 1000-watt oil heater and a thermostat maintain oil reservoir at 140 - 145 F (60 - 63 C). The heater pilot light should be on whenever the heater is on. If the pilot light is out and the reservoir is warm, check heater terminals with a voltmeter to determine if the contacts are closed. Replace bulb if necessary.

If the pilot light is out and the reservoir is colder than normal, the thermostat may be set too low, thermostat may be faulty or power may be off. Check power source, reset thermostat, replace thermostat if necessary.

*Do not operate machine when oil temperature is less than 135 F (57 C).*

The oil level in the vane seal oiler (item 36, Fig. 1) should be marked and the level checked each week.

An appreciable drop in level may indicate an oil seal leak. A leaking seal must be replaced.

**Check Purge Operation** — Frequent operation of the purge pump (several times an hour) is an indication that air is entering the machine. Locate and repair any such leaks. For leak test procedures, see Check Machine Tightness.

If water is visible in the water level sight glass (item 32, Fig. 1) drain the water per Operation 4 on the purge valve operation chart (Fig. 12).

Measure and record the amount removed. If water is continually being removed, determine the source. If water is allowed to remain in the machine refrigerant side, serious damage will result.

## SCHEDULED MAINTENANCE

*Establish a regular maintenance schedule based on your actual machine conditions (machine load, hours of operation, water quality, etc.). The time intervals in this section are offered as guides.*

**Inspect Control Center** — Maintenance is normally limited to general cleaning, tightening of connections and replacement of relays and modules. In the event of machine malfunction, refer to Troubleshooting Guide for control check and adjustment procedures.

### ▲ WARNING

**Be sure power is off when making checks and adjustments inside control center.**

**Check Safety Controls** — To ensure machine protection, the safety controls should be checked at least once during the operating season, or at least once every 6 months if machine is operated continuously. Control illustrations are shown in Table 1.

**CHILLED WATER LOW-TEMPERATURE CUT-OUT AND RECYCLE SWITCH** (item 17, Fig. 1)

1. Prepare machine for start-up; start machine.
2. Open guide vanes slowly (see Manual Operation) while observing thermostat in leaving chilled water line.
3. Cutout should stop machine at approximately 5 F (2.8 C) below design chilled water temperature, or 36 F (2.2 C), whichever is higher.
4. Chilled water pump continues to run and chilled water temperature rises. Compressor should restart at  $10 \pm 1^\circ \text{F}$  ( $5.6 \pm 0.5 \text{C}$ ) above the cut-out temperature. Program timer must complete a 15-minute delay before machine can restart.
5. Adjust switch cutout point and differential ( $10 \pm 1^\circ \text{F}$ ) ( $5.6 \pm 0.5 \text{C}$ ) range if required. Check machine operation after each adjustment. Switch must open before refrigerant low-temperature cutout in order to have automatic recycle.

## REFRIGERANT LOW-TEMPERATURE CUT-OUT (item 24, Fig. 1)

1. Jumper chilled water temperature cutout (terminal ⑩ to ⑪).
2. Start machine.
3. Open guide vanes manually while observing chilled water and refrigerant temperatures.
4. Cutout should shut off machine at 33 F (0.5 C), or at 1° F (0.5 C) below design refrigerant temperature, whichever is lower.
5. Do not allow chilled water temperature to drop below 33 F (0.5 C). Refrigerant low-temperature switch should open before chilled water reaches 33 F (0.5 C).

**OIL LOW-PRESSURE CUTOFF (item 8, Fig. 3)** — Connect high-pressure side of switch (marked HP) to a metered supply of air. Open low-pressure side to atmosphere. Quickly plug tube ends to prevent loss of machine vacuum. Switch should close on pressure rise at  $14.5 \pm 1$  psi ( $100 \pm 6.9$  kPa) differential and open on pressure fall at  $9.5 \pm 1$  psi ( $66 \pm 6.9$  kPa) differential.

**CONDENSER HIGH-PRESSURE CUTOFF (item 10, Fig. 3)** — Disconnect and quickly plug tube end. Test switch with metered air supply. Contacts should open at  $15 \pm 1$  psig ( $103 \pm 6.9$  kPa) on pressure increase. Reset switch manually as pressure is reduced below 9 psig (62 kPa).

**VANE-CLOSE OIL-PRESSURE SWITCH (item 9, Fig. 3)** — Disconnect and quickly plug tube ends. Connect high-pressure side of switch to metered air supply. Leave low-pressure side open to atmosphere. Contacts should close at about 18.5 psi (128 kPa) differential on pressure rise. Contacts should open when pressure drops 0.5 psi (3.5 kPa) below the closing pressure.

**Change Oil and Oil Filter** (see item 45, Fig. 1) yearly or if machine is opened for repairs.

To remove the oil, turn off the oil heater and raise machine pressure to approximately 5 psig (35 kPa) with nitrogen or purge pump (see Pressurizing the Machine, page 16). Attach a tube to oil charging valve (item 47, Fig. 1) and drain the oil into a container. Drain the oil filter compartment thru the drain plug (item 46, Fig. 1).

With machine pressure at approximately 0 psig (0 kPa), remove lubrication package coverplate. Install a new filter cartridge. Cartridges can be obtained thru your nearest Carrier office. Remove any metallic particles from magnetic plug in coverplate.

Add new oil charge (approximately 15 gallons [57 L]) thru oil charging valve, using a hand pump. Charge to approximately 1/3 sight glass.

Warm oil to 140 - 145 F (60 - 63 C) with oil heater. Then run oil pump for 2 minutes by pressing OIL PUMP button on control center. Add oil, if required, to maintain original level.

Oil should be visible at reservoir sight glass under all operating and shutdown conditions. Use only high grade oil which conforms to the following specifications:

Viscosity at 100 F (at 38 C)	300 $\pm$ 25 SSU (59.2 to 70.1 mm <sup>2</sup> /s)
Viscosity at 210 F (at 99 C)	50 to 55 SSU (7.3 to 8.8 mm <sup>2</sup> /s)
Viscosity index (min)	95
Pour point (max)	-5 F (-21 C)
Flash point (min)	400 F (204 C)

Rust inhibiting characteristics: material shall pass ASTM Rust Test D665, latest revision. Use Procedure A with test period of 24 hours.

Oxidation resistance: material shall pass ASTM Oxidation Test D943, latest revision, for a minimum of 2000 hours. Acid number at end of test shall not exceed 2.0 mg, KOH per gram.

**Change Refrigerant Filter and Volute Drain Filter** (items 43 and 39, Fig. 1). If item 39 is an in-line strainer rather than a filter, remove and replace it yearly.

With machine pressure at 0 psig (0 kPa), remove the steel bolt, lower the bottom half of the filter housing and replace the filter cartridge yearly. Cartridges or strainer may be ordered thru your Carrier representative.

**Compressor Bearing Maintenance** — The best bearing maintenance consists of maintaining clean oil at proper temperature and pressure in the lubricating system.

With machine-side pressure at 0 psig (0 kPa), examine bearings on a scheduled basis for signs of wear. The frequency of examination is determined by the condition of the lubrication system, hours of machine operation, type of load on machine, etc.

The removal and examination of bearings should be done only by a trained service mechanic.

Excessive bearing wear can sometimes be detected thru increased vibration or increased bearing temperature.

**Inspect Purge** — A purge in good repair protects the machine against corrosive mixtures and can prevent damage to major components.

1. Remove the cover of the purge refrigerant float chamber and thoroughly clean the chamber and float valve. Make sure that the valve operates freely thru its full travel.
2. Remove and examine the float valve plunger. Replace the plunger and seat assembly if there are signs of wear.
3. Reassemble components, using a new O-ring on chamber cover.
4. Clean the 1/16-in. (1.6-mm) orifice in the purge sampling line (Fig. 11).
5. Replace the strainer element in the orifice-strainer assembly.

Yearly replacement of the purge pump inlet and outlet valves is recommended.

**Inspect Refrigerant Flow Chamber** — With machine pressure at 0 psig (0 kPa), remove the access cover and thoroughly clean the chamber and mesh screen. Check the clearance between the flow control valve and the mounting plate as indicated in Fig. 4. Make sure that the area is free of rust, scale or debris.

**CHECK VALVE TRAVEL** — Refer to the identification number on the valve face. Then read the proper travel for that valve on the Fig. 4 chart. Press the valve inward to make sure that it moves freely throughout its full travel.

**CHECK GASKET** — Examine gasket and replace if necessary.

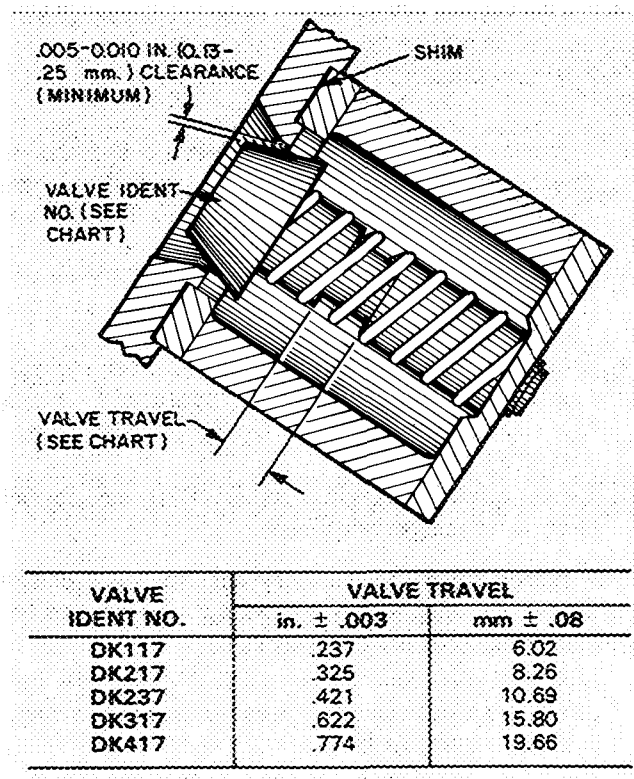

Fig. 4 — Flow Chamber Poppet Valve Detail

### Inspect Unishell Tubes

**COOLER** — Inspect and clean cooler tubes at end of first operating season. Tube condition at this time will establish the required frequency for cleaning and will indicate whether water treatment is needed in the chilled water circuit.

**CONDENSER** — Since this water circuit is usually an open system, the tubes may be subject to contamination by foreign matter and scale. Clean the condenser tubes at least once a year, and more often if the water is contaminated.

Higher than normal condenser pressures, together with inability to reach full refrigeration load, usually indicates dirty tubes, or air in the machine.

If the refrigeration log indicates a rise above normal condenser pressures, check the pressure against actual refrigerant condensing temperature as follows:

1. Install a thermometer in the condenser temperature thermowell (item 23, Fig. 1).
2. If the thermometer reading is more than 2 F (1.1 C) below the temperature corresponding to the existing pressure (see condenser pressure gage), air is present in the machine. Confirm that purge valves and switches are in Normal-Automatic position (Fig. 12). Air should vent automatically. If not, check purge operation as indicated in the Troubleshooting Guide section.
3. If, however, the thermometer reading and the temperature on the pressure gage correspond, the high condenser pressure is caused by dirty tubes or by abnormal conditions in the condensing water circuit, such as restricted flow, etc. Check operation of condensing water circuit. If water conditions (flow and temperature) appear normal, the tubes should be cleaned.

Tube cleaning brushes, specially designed to avoid scraping or scratching the tube walls, are available thru your Carrier office. *Do not use wire brushes.*

Hard scale may require chemical treatment for its prevention or removal. Consult a water treatment specialist for proper treatment.

**Inspect Starting Equipment** — Before working on any starter, shut off machine and open disconnect ahead of starter.

### ▲ WARNING

Never open isolating knife switches while equipment is operating. Electrical arcing can cause serious injury.

Inspect starter contact surfaces for wear or pitting. Do not sandpaper or file silverplated contacts. Follow starter manufacturer's instructions for contact replacement, lubrication and other maintenance requirements.

**Ordering Replacement Parts** — When ordering Carrier Specified Parts, the following information must accompany order:

1. Machine model number and serial number.
2. Name, quantity and part number of part required.
3. Delivery address and method of shipment.

## GENERAL MAINTENANCE

**Refrigerant Properties** — At normal atmospheric pressure, Refrigerant 11 is a colorless liquid which boils at 74.8 F (23.8 C). The vapor is much heavier than air and will, therefore, remain in an open container with little loss by evaporation. Above 74.8 F (23.8 C), closed containers of Refrigerant 11 are under pressure and should be opened with care.

Refrigerant 11 is practically odorless and is non-toxic (except in open flame) and noncombustible. It will, however, dissolve natural rubbers and oil, dry the skin and in heavy concentrations *displaces oxygen and may cause asphyxiation*. When handling refrigerant, protect hands and eyes and avoid breathing fumes.

**Charging Refrigerant** — Follow the instructions in the section entitled Charge Refrigerant, page 6.

### Removing Refrigerant

1. Raise cooler pressure to 5 - 8 psig (35 - 55 kPa) as described under Pressurizing the Machine.
2. Connect a length of plastic hose or copper tube to the refrigerant charging valve, and place the other end into a refrigerant container.
3. Open charging valve and allow refrigerant to flow into container.
4. Leave a space of about 3 in. (75 mm) above the liquid in the container to allow for refrigerant expansion. Above 75 F (24 C), Refrigerant 11 develops pressure in closed containers. Store containers in a cool place and open with care.

**Trimming Refrigerant Charge** — Follow procedure given in Trim Refrigerant Charge, page 11.

**Refrigerant Loss** — Some refrigerant is discharged from the machine when the purge unit removes air and noncondensables. Any leak which causes frequent purge cycling should therefore be repaired without delay.

**Air and Water Leaks** — Air in the machine causes higher than normal condenser pressure, compressor surge at start-up and frequent purge cycling. Locate and repair any air leaks as soon as possible.

Higher than normal condenser pressure can also be caused by dirty tubes, high entering water temperature or lack of condensing water. To determine if air is the cause, check condenser and refrigerant temperatures as described under Inspect Unishell Tubes, page 15.

**LEAK TESTING** — Refrigerant can remain in the machine when leak testing. Refrigerant removal, however, will minimize refrigerant loss. If the refrigerant is removed, charge approximately one gallon (3.8 L) of Refrigerant 11 into machine before pressurizing.

Pressurize the machine as described on this page and then test all joints and flanges with a halide or

electronic leak detector. Be sure room is free of concentrations of refrigerant when leak testing.

Water leaks during machine shutdown can be detected by a rise in refrigerant level. Water leaks during machine operation are indicated by frequent and excessive accumulation of water in the purge separation chamber. Water leaks should be repaired immediately.

### ⚠ CAUTION

Machine must be dehydrated after repair of water leaks. See Machine Dehydration, page 6.

**Pressurizing the Machine** — Whenever the machine vacuum must be broken for service work or for extended shutdown, nitrogen is recommended. Dry nitrogen is preferable to air as it does not introduce moisture into the machine. *Never use oxygen for pressurizing*. To pressurize with nitrogen or dry air:

1. Connect copper tube from pressure cylinder to cooler charging valve. Never apply full cylinder pressure to the pressurizing line. Follow the steps below in proper sequence.
2. Open cooler charging valve fully.
3. Open cylinder regulating valve slowly.
4. Observe cooler pressure gage and close cylinder regulating valve when test pressure of 5 - 8 psig (35 - 55 kPa) is reached. *Do not exceed 10 psig (69 kPa)!*
5. Close cooler charging valve. Remove copper tube if no longer required.

If nitrogen or bottled dry air are not readily available, the machine purge pump may be used for pressurizing with air as follows:

1. Open purge valve connection A (Fig. 10) and admit air until machine pressure reaches atmospheric (0 psig) (0 kPa).
2. Drain any water from purge condensing chamber thru valve 1 (Fig. 10).
3. Pressurize machine per Operation 3 on purge valve chart (Fig. 12).
4. Stop purge pump when machine pressure reaches 5 - 8 psig (35 - 55 kPa). *Do not exceed 10 psig (69 kPa).*

To return the machine to normal operating pressure, follow Operation 2 on the purge valve chart (Fig. 12). Remove sufficient air to allow the machine to operate. Then place purge valves and switches in Normal-Automatic condition.

**TESTING AT HIGHER PRESSURE** — If leaks are undetected at normal test pressure (5 - 8 psig) (35 - 55 kPa), tests may be made at a maximum of 15 psig (103 kPa) *with the following provisions*.

1. Equalize rupture disc pressure (see Fig. 5).
2. Pressurize machine to 15 psig (103 kPa) maximum.
3. Perform leak test.
4. *After pressure has been reduced to normal, remove equalizing line and provide full 2-in. (51-mm) passage to rupture disc.*

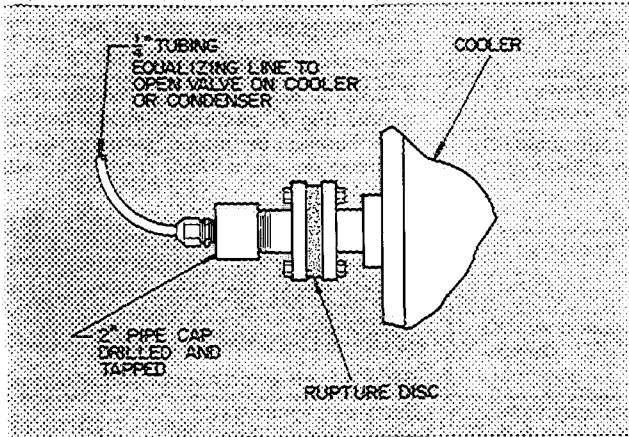

**Fig. 5 — Equalizing Rupture Disc Pressure**

**Guide Vane Linkage** — 19DK guide vane and linkage assembly is carefully adjusted at factory.

When the machine is off, the guide vanes are closed and the vane actuator is stopped by a limit switch at the position shown in Fig. 6.

If motor crankarm is in proper position at machine shutdown, but vane crankarm is not, guide vanes are not fully closed. Loosen vane crankarm

linkage connector; close vanes tightly by hand and reconnect linkage.

If motor crankarm is not in proper position, test relay K2 by substituting relay K3 (Fig. 3). If arm fails to move, loosen setscrews and examine shaft for slippage marks. If none, actuator switches or windings may be defective. Check for proper voltage at actuator terminals. If voltage is correct, replace actuator.

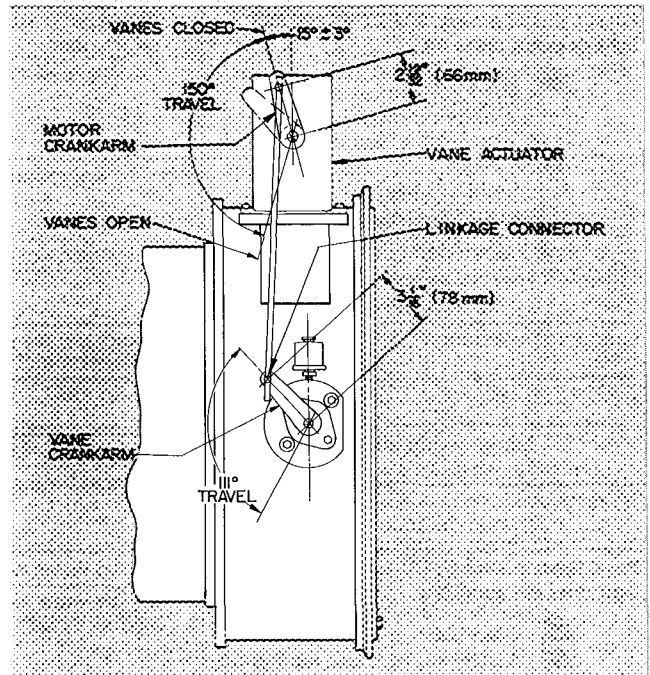
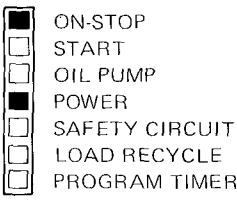
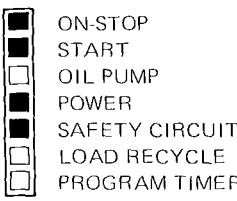

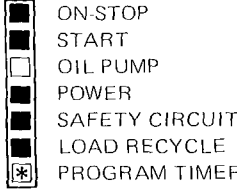

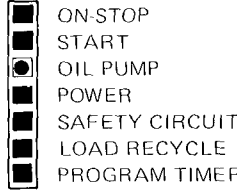

**Fig. 6 — Guide Vane Linkage (Closed Position)**

# TROUBLESHOOTING GUIDE

For pictorial identification of Design model, refer to Fig. 1 and 3.

## TROUBLE/SYMPTOM – COMPRESSOR WILL NOT START

SYMPTOM	PROBABLE CAUSE	REMEDY
<b>All panel lights out.</b>	No control power	Check for building power failure Check main circuit breaker
	Blown fuse	Check 15-amp fuse in control circuit; examine circuit for ground or short.
<b>Panel lights as shown; SAFETY CIRCUIT light does not come on.</b> 	Bearing or motor winding temperature switch open	If BRG or MTR indicating light on relay module (Fig 3) is lit, check immediately for high bearing or motor temperature. If temperatures are normal, check relay KB and KM  <div style="border: 1px dashed black; padding: 2px; width: fit-content;">                     If compressor trips out, check immediately for high bearing or motor temperatures. If present, DO NOT RE-START without proper corrective action.                 </div> Reset is made by pressing ON-STOP button.
	Cooler low-temperature or condenser high-pressure switch tripped	Reset switch manually
	Blown fuse	Check 3-amp fuse in control circuit; examine circuit for ground or short
	Compressor motor overloads tripped	Reset overloads in starter
	Program timer switch PT-4 in N C position	Remove control power and check continuity between (17) and (14), if open, check PT-4
<b>Panel lights as shown; LOAD RECYCLE light does not come on.</b> 	Chilled water temperature too low	Check water temperature
	Chilled water low-temperature switch incorrectly set	Check setting of switch
 <b>PROGRAM TIMER light goes on momentarily, then out.</b> 	1CR normally closed contact open	Check for 120 volts between (15) and (L2)
 <b>OIL PUMP light goes on 10 to 30 seconds after pushing START button; goes out after about one minute. START lights stays on.</b> 	Vane-Closed switch open	Check continuity between (V1) and (61); if none, check guide vane adjustment linkage per Fig. 6. If actuator is not in fully closed position, check relay K2.
	Start relay 1CR inoperative	Check for 120 volts between (V2) and (L2) Voltage should be present for 10 seconds approximately 1/2 minute after oil pump starts. If not, check PT-3; if so, then remove all power to main starter and examine 1CR relay

**TROUBLE/SYMP TOM – COMPRESSOR WILL NOT START**

SYMPTOM	PROBABLE CAUSE	REMEDY
<p><input checked="" type="checkbox"/> <b>OIL PUMP light goes on 10 to 30 seconds after pushing START button; goes out after about one minute. START light goes out.</b></p> <p> <input type="checkbox"/> ON-STOP  <input type="checkbox"/> START  <input checked="" type="checkbox"/> OIL PUMP  <input type="checkbox"/> POWER  <input type="checkbox"/> SAFETY CIRCUIT  <input type="checkbox"/> LOAD RECYCLE  <input type="checkbox"/> PROGRAM TIMER                 </p>	Water pumps not running	Start pumps Check pump starter(s) and relay(s)
	Water flow switches open (pumps running)	Check contacts of flow switches Check for air in water line; vent air
	Oil pump starter auxiliary contacts M3 open (oil pressure normal)	Check contacts
	Oil pump not operating (check by pressing OIL PUMP button)	Push ON-STOP button (light out) and then: Check for open oil pump disconnect Check for faulty pump wiring Check for faulty oil pump
	Oil pump operates but oil pressure low	Check oil level Check for dirty oil filters; replace. Check oil pressure regulating valve
	Oil low-pressure switch open (oil pressure normal)	Check setting of oil low-pressure switch Check that both sets of contacts close when oil pressure is normal

**TROUBLE/SYMP TOM – COMPRESSOR TRIPS OFF (Note: See Machine Recycle, page 29)**

SYMPTOM	PROBABLE CAUSE	REMEDY
<p>All panel lights out.</p>	Power failure	Check for building power failure Check main circuit breaker and/or fuses
	Blown fuse	Check 15-amp fuse in control circuit; examine circuit for ground or short
<p><input checked="" type="checkbox"/> <b>OIL PUMP light goes out approximately 40 seconds after compressor stops. START light goes out, but SAFETY CIRCUIT light stays on.</b></p> <p> <input type="checkbox"/> ON-STOP  <input type="checkbox"/> START  <input checked="" type="checkbox"/> OIL PUMP  <input type="checkbox"/> POWER  <input type="checkbox"/> SAFETY CIRCUIT  <input type="checkbox"/> LOAD RECYCLE  <input type="checkbox"/> PROGRAM TIMER                 </p>	Low oil pressure	Check oil level in reservoir Check for dirty oil filters
	Oil pump not operating (button depressed)	Check for open oil pump disconnect Check for faulty pump wiring Check for faulty oil pump
<p>Panel lights as shown; <b>START light and SAFETY CIRCUIT light go out.</b></p> <p> <input type="checkbox"/> ON-STOP  <input type="checkbox"/> START  <input type="checkbox"/> OIL PUMP  <input checked="" type="checkbox"/> POWER  <input type="checkbox"/> SAFETY CIRCUIT  <input type="checkbox"/> LOAD RECYCLE  <input checked="" type="checkbox"/> PROGRAM TIMER                 </p>	Water-flow switch(es) open	Pump(s) off; check starting equipment Insufficient water flow; check water valves Check for air in water lines; vent air Defective flow switch; check contacts of switch
	Bearing high temperature switch open; bearing temp light at relay module is on	<p>Check bearing thermometer. If over 180 F (82 C), or if no one was present when machine stopped, DO NOT ATTEMPT TO RESTART MACHINE until cause is determined.</p> <p>Check for high oil reservoir temperature Check oil cooler water flow Check relay KB</p>
	High motor winding temperature switch open; motor temp light at relay module is on	Check motor cooling system; clean orifices; clean refrigerant strainer Check relay KM
	Momentary power interruption. Motor temp light goes on	If power interruption is suspected, press ON-STOP button. If motor temp light then goes out, start machine and carefully monitor motor temperature
	Cooler low-temperature switch tripped	Manually reset switch and: Check that capacity control switch is at AUTO position Check for refrigerant loss. Determine and correct cause and add refrigerant Low chilled water recycle switch should trip out machine before cooler low temperature switch. If chilled water temperature is low, check settings of both switches

**TROUBLE/SYMP TOM – COMPRESSOR TRIPS OFF (Note: See Machine Recycle, page 29)**

SYMPTOM	PROBABLE CAUSE	REMEDY
Panel lights as shown; START light and SAFETY CIRCUIT light go out.	Condenser high-pressure switch tripped	Manually reset switch and: Check condensing water flow Check condenser water temperature; if high, examine cooling tower operation Check for air and water leaks, fouled tubes (see Maintenance section)
	Motor overload relays tripped	Manually reset relays in starter and: Check that guide vanes stop opening when motor current exceeds 100% of full load amps Adjust electrical demand control, if required, per 19DK Initial Start-Up section Check overload relay setting per starter manufacturer's instructions
	Blown fuse	Check 3-amp fuse in control circuit; examine circuit for ground or short

**TROUBLE/SYMP TOM – COMPRESSOR RUNS BUT MACHINE MALFUNCTIONS AS NOTED**

MALFUNCTION	PROBABLE CAUSE	REMEDY
COMPRESSOR RUNS BUT GUIDE VANES WILL NOT OPEN. K2 light is ON	Capacity control switch improperly set	Turn switch to AUTO position
	Compressor not in RUN condition	At least one minute after compressor starts, check for 120 volts across <b>18</b> and <b>L1</b> .
	K2 or K3 relay open	Check continuity between <b>73</b> and <b>74</b>
	Motor current calibration incorrect	See Calibrate Motor Current, page 9
	Chilled water probe defective	Check probe resistance per Fig 7 Replace.
	Incorrect voltage in capacity control module	Check voltage between terminals as indicated Replace module if voltage varies by more than amount specified in Table

MODULE TYPE	TEST VOLTAGES		
	<b>83</b> to <b>28</b>	<b>30</b> to <b>28</b>	<b>81</b> to <b>28</b>
A	28± 3 v ac	+24± 1 v dc	-24± 1 v dc
B	12± 1.5 v ac	+ 9± 5 v dc	—

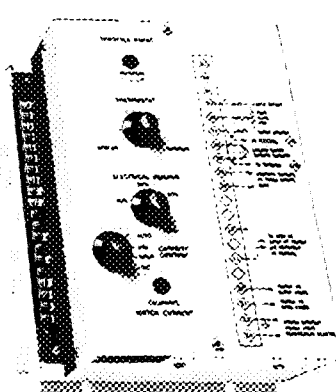

TYPE A

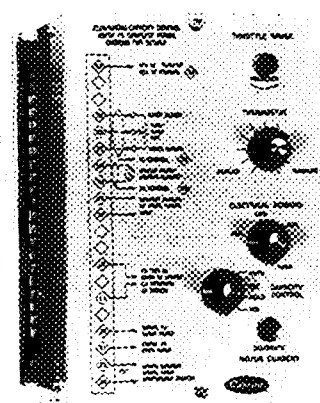

TYPE B

K2 light is OFF	Guide-vane-close oil pressure switch is open or defective	Ensure that oil pressure is at least 19 psi (131 kPa) differential Check for 120 volts between <b>31</b> and <b>L2</b>
CHILLED WATER TEMPERATURE TOO HIGH (machine running)	Thermostat set too high	Return thermostat to proper setting as marked on dial at initial start-up
	Excessive cooling load (machine at capacity)	Check for infiltration of outside air into conditioned spaces
	Condenser temperature too high	Check condensing water flow Check condensing water temperature; examine cooling tower operation Check for air and water leaks, fouled tubes
	Refrigerant level low	Check for leak; repair Add refrigerant
	Liquid bypass in water box.	Examine division plates and gaskets for leaks

**TROUBLE/SYMPOM – COMPRESSOR RUNS BUT MACHINE MALFUNCTIONS AS NOTED**

<b>MALFUNCTION</b>	<b>PROBABLE CAUSE</b>	<b>REMEDY</b>
<b>CHILLED WATER TEMPERATURE TOO HIGH (machine running)</b>	Excess throttling range (should be near minimum for proper control)	Reduce throttling range by turning adjusting screw clockwise in small increments
	Guide vanes fail to open fully.	Ensure that capacity control switch is in AUTO position. If vanes will not open with switch at INC, check for excessive cooling load (see above). Check relays K2 and K3. Check guide vane linkage (See Fig. 6 ) If all else fails, replace capacity control module
<b>CHILLED WATER TEMPERATURE TOO LOW (machine running)</b>	Thermostat set too low.	Return thermostat to setting marked on dial at initial start-up.
	Low chilled water switch improperly set	Water chilling duty – Switch should open at 5 F (2.8 C) below design chilled water temperature, or at 37 F (2.8 C), whichever is higher. Brine chilling duty – Switch should open at 5 F (2.8 C) below design leaving brine temperature.
	Excess throttling range (should be near minimum for proper control)	Reduce throttling range by turning adjusting screw clockwise in small increments
	Guide vanes fail to close	Ensure that capacity control switch is in AUTO position Check chilled water probe resistance per Fig. 7. Check guide vane linkage (See Fig 6 ) If all else fails, and vanes close in DEC. but not in AUTO, replace capacity control module
<b>CHILLED WATER TEMPERATURE FLUCTUATES: VANES HUNT</b>	Throttling range too narrow	Add throttling range by turning adjusting screw counterclockwise in small increments
	Defective capacity control module	Replace module
	Loose vane linkage	Adjust guide vane linkage (See Fig. 6.)
	Defective vane actuator	Replace actuator
<b>OIL RESERVOIR TEMPERATURE TOO LOW</b>	Oil cooler water flow too high	Throttle water to reduce flow
	Thermostat improperly set or defective	Check voltage across thermostat while adjusting it; if contacts do not close, replace thermostat
	Oil heater defective	If light indicates power but unit does not heat, check unit for open or short. Replace unit if required
<b>OIL RESERVOIR TEMPERATURE TOO HIGH</b>	Thermostat improperly set	Adjust thermostat
	Oil cooler water flow too low	Open plug valve (item 44, Fig 1)
	Oil cooler solenoid valve operating improperly	Check electrical operation of solenoid Inspect valve; if screen is fouled, install a 20-mesh screen ahead of valve
	Oil cooler tubes fouled	Clean or replace tubes if required
<b>PURGE DOES NOT OPERATE IN AUTO. POSITION</b>	Normal	Purge pump does not operate unless purge pressure is within 2 to 4 psi (14 to 28 kPa) of condenser pressure. Check gage readings
	Blown fuse (On some units )	Check 15-amp fuse inside purge electrical switch box (on some units).
	Loose connections or broken wires	Check purge control switch connections Check circuit to purge motor, indicator light, solenoid switch and solenoid valve by switching to MANUAL Check purge operating and safety switch connections
	Defective purge control switch	Check switch continuity; replace switch if required
	Incorrect purge safety or operating switch settings	Check switches per Table 2 with metered supply of air. Recalibrate or replace as required

**TROUBLE/SYMPTOM – COMPRESSOR RUNS BUT MACHINE MALFUNCTIONS AS NOTED**

MALFUNCTION	PROBABLE CAUSE	REMEDY
<b>PURGE CYCLES OFTEN IN AUTO. POSITION</b>	Purge valves not tightly closed	Check valve settings per purge valve chart (see Fig 12). Close applicable valves <i>securely</i>
	Solenoid and check valve leaking	Allow smoke to drift past connection B (Fig. 11) If smoke is drawn into line, repair or replace valves
	Incorrect purge operating switch setting	Check switch per Table 2 with metered supply of air. Recalibrate or replace as required
	Excessive air leakage into machine	Check machine for leaks per Air and Water Leaks section, page 16.
	Purge condensing chamber float valve stuck in closed position, or refrigerant return line plugged	If refrigerant level is above sight glass, valve is stuck or line is plugged. Correct as required
<b>EXCESSIVE REFRIGERANT LOSS</b>	Purge pump cycles often	See Purge Cycles Often in AUTO Position, above

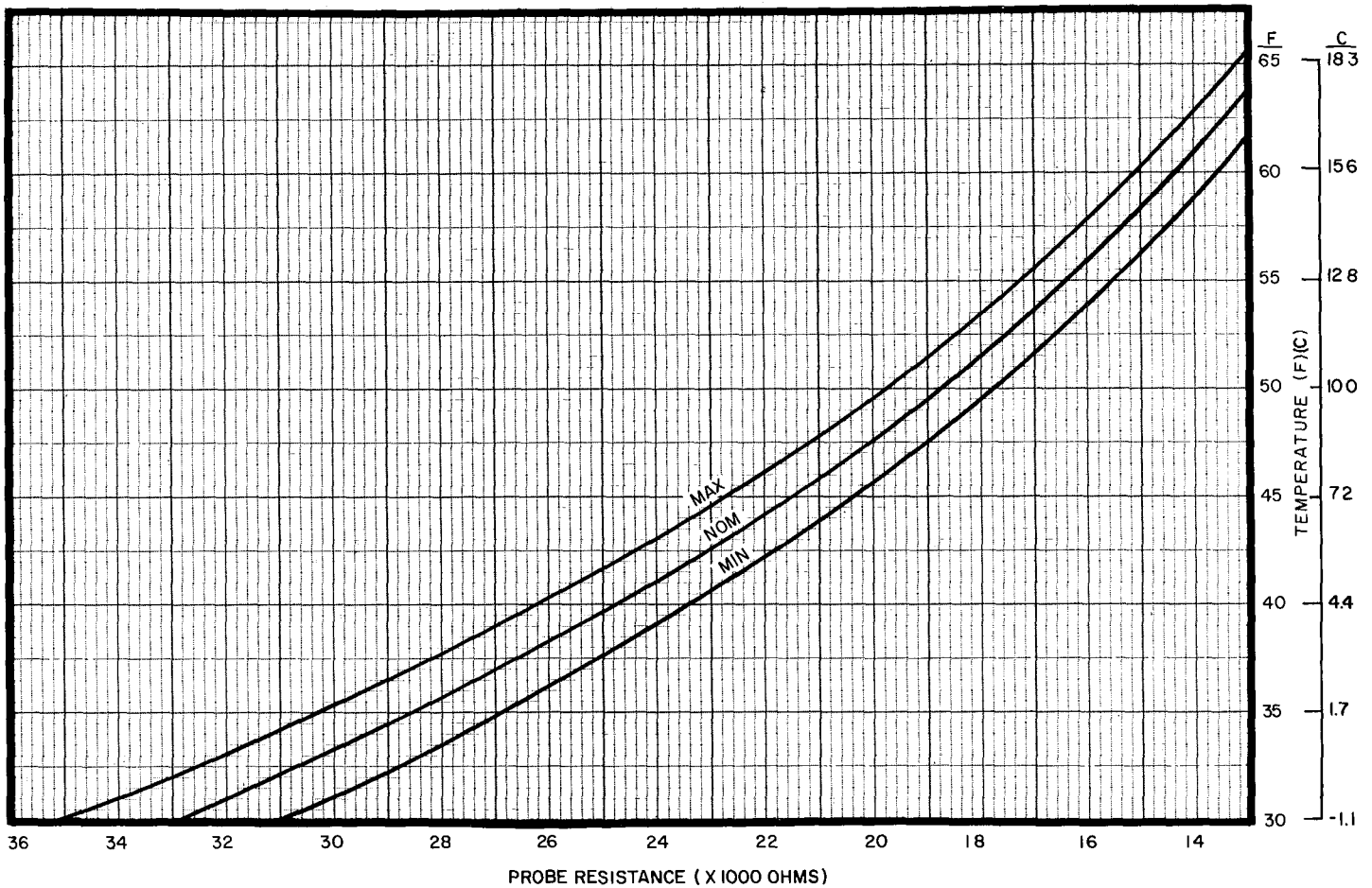

**Fig. 7 — Chilled Water Probe Resistance versus Temperature (Electronic Control Only)**

## GENERAL DATA

**Machine Informative Plate** (item 5, Fig. 1) is located on the compressor support base at the left of the machine control center.

**System Components** include cooler and condenser heat exchangers within a single shell (unishell), motor-compressor, lubrication package, purge and control center.

**COOLER** — This heat exchanger, in the bottom portion of the unishell, is maintained at low temperature-pressure so that evaporating refrigerant can remove heat from water flowing thru its tubes.

**CONDENSER** — Heat exchanger, in the unishell upper portion, operates at a higher temperature-pressure at which heat may be removed from the refrigerant and be passed out of the system.

**MOTOR-COMPRESSOR** maintains system temperature-pressure differences and moves the heat carrying refrigerant from cooler to condenser.

**LUBRICATION PACKAGE**, consisting of oil pump, filter, cooler and thermostatically controlled heater, lubricates the motor-compressor, maintains the oil at proper operating temperature and pressure and removes foreign particles.

**PURGE** automatically separates air or other non-condensables from the refrigerant and collects any water for periodic manual removal. Purge may also be used for machine evacuation or pressurization.

**CONTROL CENTER** regulates machine capacity as required, registers cooler, condenser and lubricating system pressures, shows machine operating condition thru indicating lights, contains machine safety devices and records machine operating hours. Machine start, stop and recycle is sequenced by a program timer within the control center.

## REFRIGERATION CYCLE

The compressor continuously draws refrigerant vapor from the cooler, at a rate set by the amount of guide vane opening. As the compressor suction reduces the pressure in the cooler, the remaining refrigerant boils at a fairly low temperature (typically 34 - 38 F (1 - 3 C)). The energy required for boiling is obtained from the water flowing thru the cooler tubes. With heat energy removed, the water becomes cold enough for use in an air conditioning circuit or process liquid cooling.

After taking heat from the water, the refrigerant vapor is compressed. Compression adds still more heat energy and the refrigerant is quite warm (typically 100 - 105 F [38 - 41 C]) when it is discharged from compressor into condenser.

Relatively cool (typically 65 - 85 F [18 - 29 C]) water flowing thru the condenser tubes removes heat from the refrigerant and the vapor condenses to liquid. The condensing water carries the heat out of the system while the cooled liquid refrigerant passes thru orifices into the FLASC chamber. See Fig. 8.

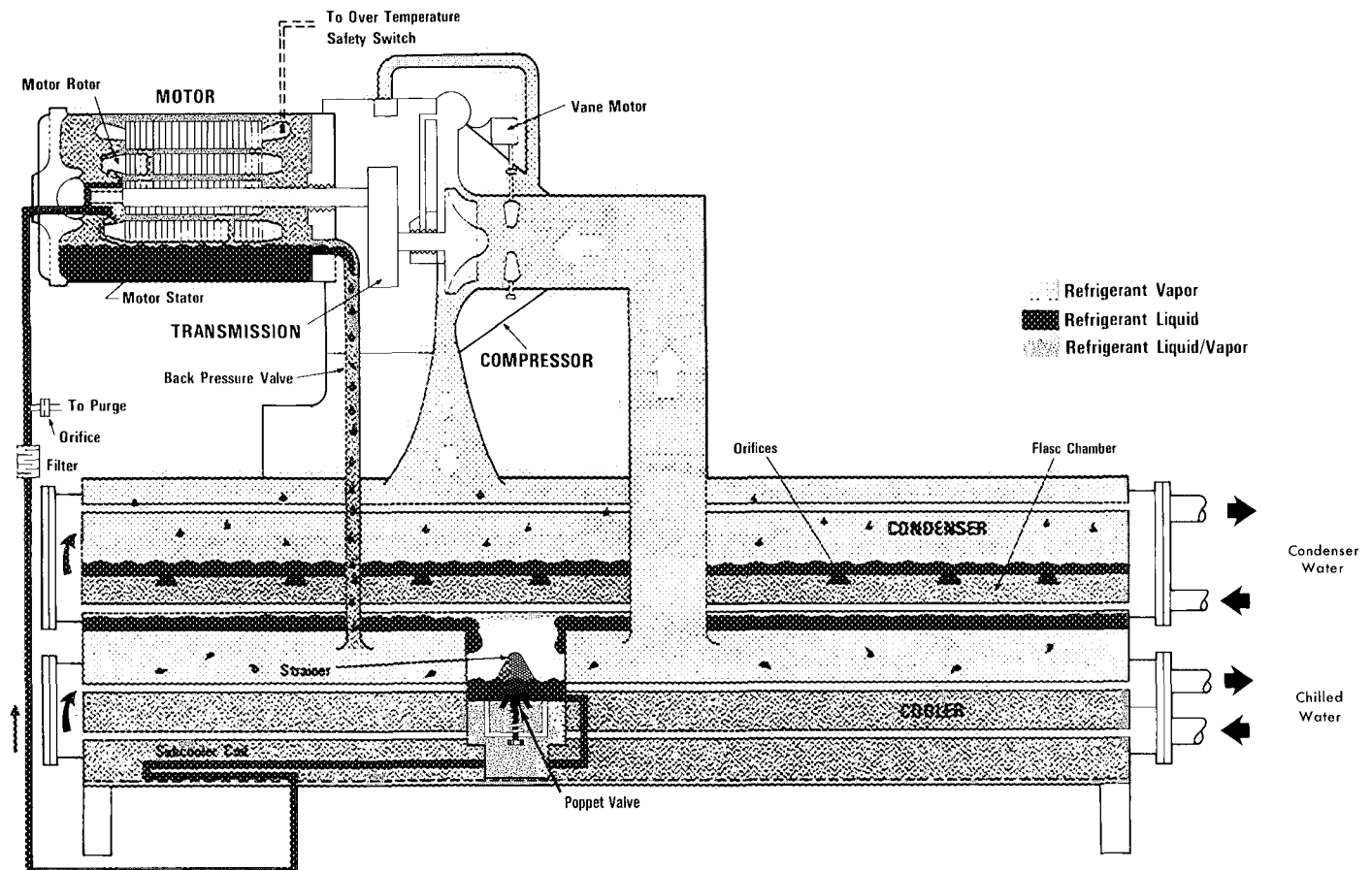

Fig. 8 — Refrigeration and Motor Cooling Cycles

At this lower pressure, part of the liquid refrigerant flashes to gas, thus cooling the remaining liquid. The FLASC vapor is condensed by the coolest (entering water) condenser tubes. The liquid drains into a flow chamber between the FLASC chamber and cooler. Here a poppet valve forms a liquid seal to keep FLASC chamber vapor from entering the cooler and to maintain a pressure difference of at least 6 - 8 psi (41 - 55 kPa) between FLASC chamber and cooler.

When liquid refrigerant passes thru the valve, some of it flashes to vapor in the reduced pressure on the cooler side. In flashing, it removes heat from the remaining liquid. The refrigerant is now at temperature and pressure at which cycle began.

At low loads, the poppet valve allows small amounts of FLASC chamber gas to pass into the cooler. The gas agitates the liquid refrigerant, which raises the effective refrigerant level and improves heat transfer.

### MOTOR COOLING CYCLE

The motor is cooled by refrigerant taken from the poppet valve chamber at FLASC pressure. The flow is maintained by pressure difference in the system.

The liquid refrigerant first flows thru a subcooler coil at the bottom of the cooler (Fig. 8). It then

passes thru a filter to spray nozzles at the end of the rotor. The spray nozzles direct the refrigerant over both the rotor and the stator. The cycle is completed by the return of the refrigerant to the cooler.

When the condensing temperature and pressure are low, as at start-up and low load, the poppet valve (Fig. 4 and 8) remains closed until cooler-condenser pressure difference is sufficient for good refrigerant flow thru the motor cooling circuit.

The compressor motor is protected against high temperature by a thermostat imbedded in the windings. Above-normal motor temperature will immediately shut down the machine.

### LUBRICATION CYCLE

**Summary** — The oil pump, filter and cooler make up a package located partially within the end of the unishell (Fig. 9). The oil is pumped thru the filter-cooler to remove foreign particles and excess heat. Part of the oil flow is directed to the compressor motor end bearing. The remaining flow lubricates the compressor transmission, journal and thrust bearings. Oil then drains into the reservoir to complete the cycle.

**Details** — Oil is charged into the lubrication package thru a hand valve. A sight glass in the oil reservoir permits oil level observation.

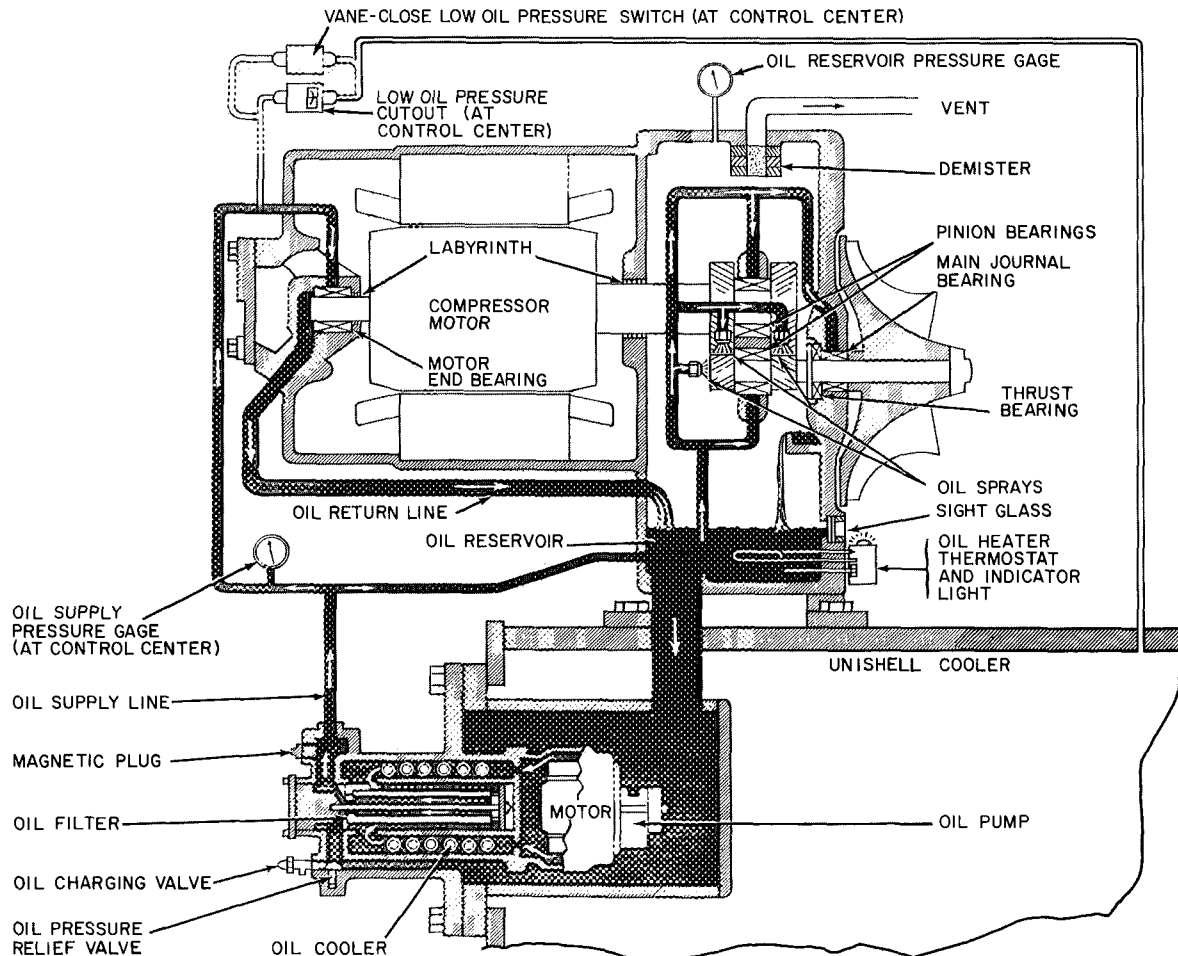

Fig. 9 — Lubrication Cycle

Oil pump discharges oil thru oil filter and oil cooler coils. Oil cooler water flow may be adjusted by a plug valve to maintain proper oil temperature (140 - 150 F) (60 - 66 C). If desired, the customer may install a throttling valve for this purpose. A solenoid valve shuts off the water supply at machine shutdown.

An oil pressure relief valve maintains 20 - 25 psi (138 - 172 kPa) differential pressure in the system. This differential pressure can be read by subtracting oil reservoir pressure from oil supply pressure.

Oil leaving the filter cooler passes over a magnetic plug which removes any metallic particles. A portion of the oil then flows to the motor end bearing and the balance lubricates the compressor thrust and journal bearings and the transmission. As the oil leaves the transmission and main bearings, its temperature is registered on a gage.

The oil now drains into a reservoir at the base of the compressor. Gages on the compressor casing register the temperature and pressure of the oil in the reservoir. An oil heater, with thermostat and indicating light, maintains oil reservoir temperature at 140 - 145 F (60 - 63 C) on machine shutdown.

To ensure proper compressor lubrication during start-up and coastdown, a program timer in the machine control center energizes the oil pump for about 30 seconds before the compressor starts and keeps the pump running for about 40 seconds after the compressor motor is de-energized.

A guide-vane-close oil pressure switch minimizes oil foaming at start-up. If the guide vanes open quickly, the sudden drop in suction pressure can cause any refrigerant in the oil to flash. The resulting oil foam cannot be pumped efficiently; oil pressure falls off and lubrication is poor. The vane-close switch opens when oil pressure drops below 18.0 psi differential (124.5 kPa) and causes the guide vanes to close by de-energizing relay K2.

If oil pressure drops to approximately 10 psi (69 kPa) differential, an oil low-pressure cutout will shut down the machine.

### PURGE CYCLE

The purge removes water, air or other non-condensable gases from the refrigerant system. It indicates air and water leaks and may be used to evacuate or pressurize the machine.

A sampling line from the condenser (Fig. 11) continually brings refrigerant gas, and any contaminants, into the purge condensing chamber. Here the gas-vapor mixture passes over a cooling coil. Since the refrigerant liquid within the coil is colder than the mixture surrounding it, the refrigerant gas and water are condensed to liquid.

Water, if present, separates from and floats on the heavier refrigerant. The water level may be observed thru a sight glass and the water may be withdrawn manually at the water drain valve (Fig. 10). The

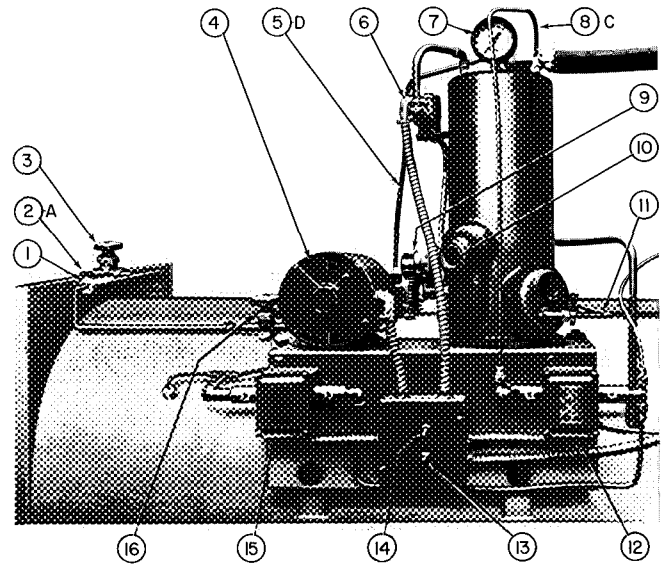

- |   |  |
|---|--|
| 1 — Strainer-Orifice Assembly                       | 9 — Valve No 1 (Water Drain)                         |
| 2 — Connection A, 1/2-in Flare                      | 10 — Water Sight Glass                               |
| 3 — Valve No. 3                                     | 11 — Refrigerant Level Sight Glass                   |
| 4 — Purge Pump                                      | 12 — Purge Operating Switch, P2                      |
| 5 — Tubing D (solenoid valve to purge pump suction) | 13 — Purge Pump Switch (Auto.-Off-Man.)              |
| 6 — Solenoid Valve                                  | 14 — Solenoid Switch                                 |
| 7 — Purge Pressure Gage                             | 15 — Purge Safety Switch, P1 (on purge-to-P2 tubing) |
| 8 — Flare Connection C                              | 16 — Valve No 2                                      |

Fig. 10 — Purge Component Location

liquid refrigerant flows thru a U-trap and a float valve back to the cooler.

Air and other noncondensable gases collect in the upper part of the condensing chamber. When accumulating air raises the chamber pressure to within 2 psi (14 kPa) of machine condenser pressure, the purge operating switch energizes the purge pump and opens the purge vent solenoid. The air is then discharged thru connection B (valve 6), Fig. 10.

Since machine condenser pressure and purge chamber pressure also equalize at machine shutdown, air and then refrigerant could be discharged each time the machine stops. To prevent this, a purge safety switch opens whenever cooler and condenser pressure difference drops below 6 - 8 psi (41 - 55 kPa). The safety switch deactivates the purge AUTO. circuit until machine operation again builds up pressure differences within the refrigerant system.

Table 2 — Safety and Operating Switch Settings

SWITCH	NORMAL POSITION	DIFFERENTIAL PRESSURE SETTING		CONNECTION
		Cutout	Cut-in	
Purge Safety (P1)	Open	6 psi (41 kPa)	8 psi (55 kPa)	Cond-Cooler
Purge Oper (P2)	Closed	4 psi (28 kPa)	2 psi (14 kPa)	Purge Cond-Machine Cond

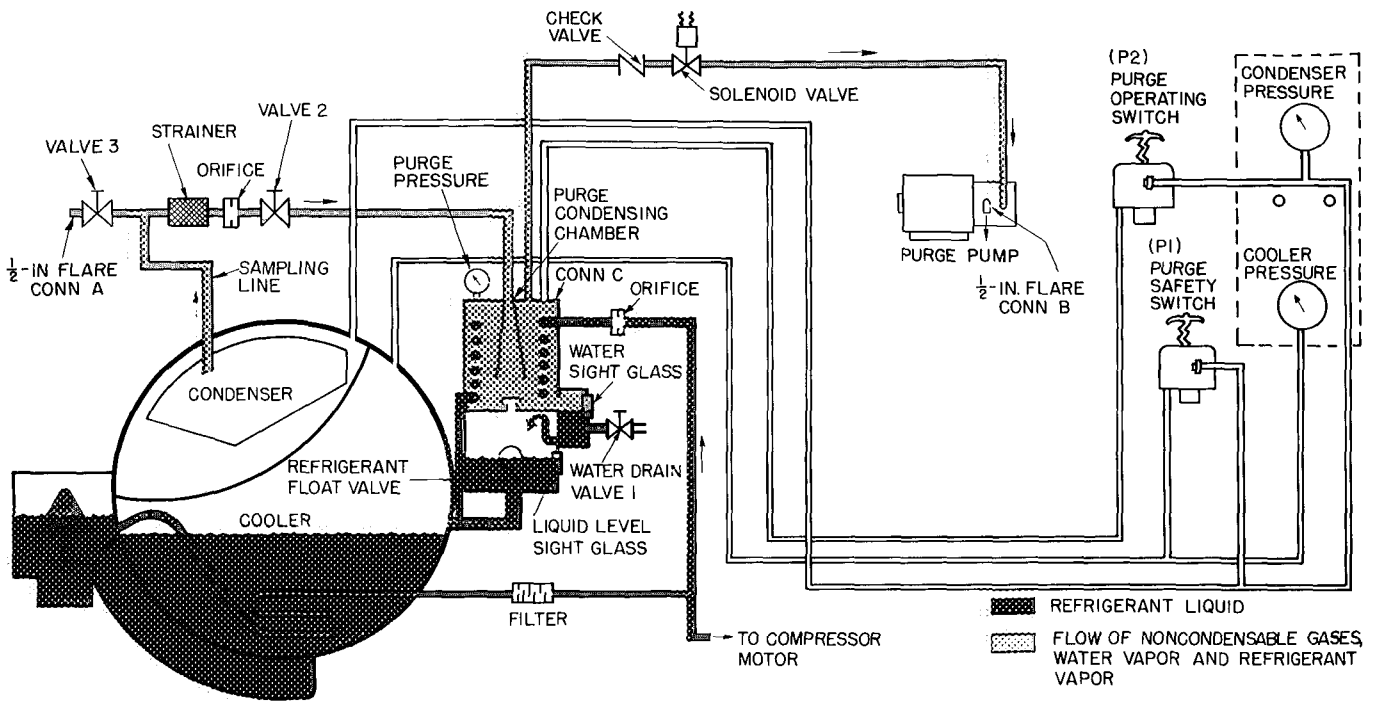

Fig. 11 — Purge Cycle

OPERATION	VALVE NUMBER			SWITCH	
	1	2	3	Purge	Sol
1 Normal-Automatic	Close	Open	Close	Auto	On
2 Remove air after opening machine (See Note 1)	Close	Close	Open	Man	Off
3 Pressurize system for leak test (See Note 2)	Close	Close	Open	Man	Off
4 Remove water (See Note 3)	Open Note 3	Close	Close	Off	Off

NOTES:

- 1 Remove tubing D (Fig 10) between purge solenoid valve and purge pump suction. Connect tubing or hose between connection A and pump suction.
- 2 Connect hose or tubing between connection A at valve 3 and connection B at purge pump outlet (see Fig. 11). Remove tubing D between purge solenoid valve and purge pump suction.
- 3 If possible, raise machine pressure by raising chilled water temperature. This will minimize the amount of air admitted into the system. Open flare connection C (Fig 10). When purge pressure reaches atmospheric, open water drain valve 1.

Fig. 12 — Purge Valve and Switch Settings

**Purge Operation** — The standard operating mode is NORMAL-AUTOMATIC. The purge MANUAL-OFF-AUTO. switch is placed at AUTO. position and the solenoid switch at ON. As the machine starts up, the purge safety switch will close and the purge operating switch will open. The purge pump and solenoid valve will be energized whenever purge chamber pressure nears machine condenser

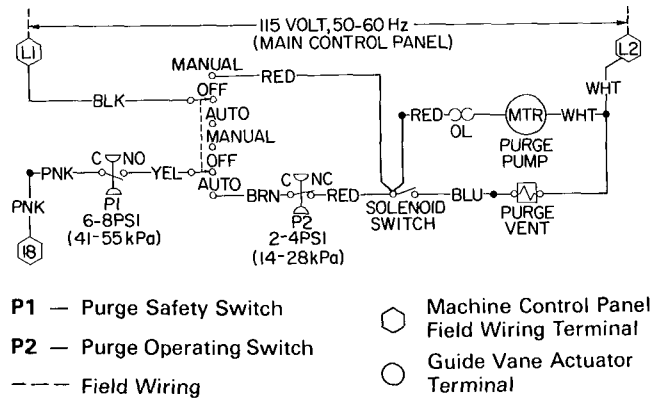

Fig. 13 — 19DK Purge Wiring Schematic

pressure. When the chamber pressure drops during air discharge, the pump and solenoid valve will de-energize automatically.

If the control switch is placed at the MANUAL position, the purge pump will operate continuously without regard to whether the safety and operating switches are closed or open. Manual operation is used for removing air from the machine after service work or for pressurizing the machine for leak testing.

## CONTROLS

**Description** — Machine capacity is controlled by the opening and closing of compressor guide vanes. A temperature sensing probe in the leaving chilled water circuit transmits signals to a capacity control module. In response to probe signals, the module activates the compressor guide vane motor, moving the guide vanes towards a closed position as chilled water temperature decreases, and opening the vanes as temperature rises.

If at any time compressor motor current requirements should exceed the electrical demand control setting (item 17, Fig. 3), a signal from the compressor motor starter overrides the signal from chilled water temperature probe. The guide vanes will then move towards a closed portion until motor current falls below electrical demand setting.

Safety controls shut down machine to protect it against damage from compressor bearing high temperature, motor-winding high temperature, cooler refrigerant low temperature, condenser high pressure, low oil pressure and loss of water flow. These shutdowns require manual restart.

If chilled water temperature should drop approximately 5 F (3 C) below the selected set point, the chilled water low-temperature cutout and recycle switch will stop the compressor. The compressor will restart automatically when the water temperature rises to approximately 5 F (3 C) above the set point and the program timer has completed a 15-minute delay between compressor stop and restart.

The vanes-closed switch ensures that compressor starts in an unloaded condition (guide vanes closed).

The guide-vane-close oil pressure switch is described in the Lubrication Cycle section, page 24.

**Program Timer** (item 3, Fig. 3) — The 19DK program timer ensures positive compressor lubrication prior to compressor start and during coastdown after machine stop. It prevents short cycling and motor damage by preventing compressor restart until 15 minutes after stop.

The program sequences are graphically illustrated in Fig. 14. Switch numbers and positions are those marked on the machine wiring schematic, Fig. 16.

**Oil Heater and Thermostat** — These items are typically wired by the field as indicated in Fig. 15.

**Machine Control Wiring** — Typical machine control is shown schematically in Fig. 16.

Your machine wiring may differ in some details. Check your individual Job Data.

Numbers at the right side of the diagram indicate location of relay contacts. Underlining indicates that the contact is normally closed.

### Typical Control Sequence — Machine Start (Refer to Fig. 16.)

1. Supply power to machine.

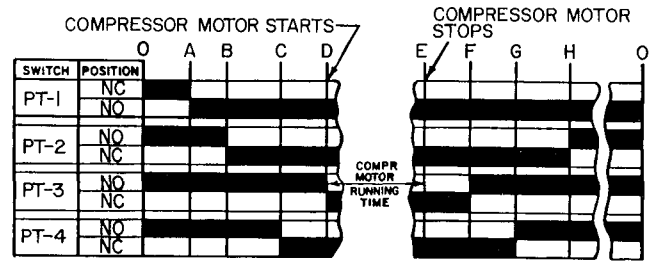

- O = Starting sequence begins (condition shown on schematic)
- A = 13 ± 5 sec after O
- B = 10 ± 5 sec after A (oil pump starts)
- C = 15 ± 5 sec after B
- D = 13 ± 5 sec after C (compressor motor starts and program timer stops)
- E = Time at which compressor motor stops and program timer restarts
- F = 13 ± 5 sec after E
- G = 13 ± 5 sec after F
- H = 15 ± 5 sec after G (oil pump stops)
- O = 15 min ± 15 sec total cycle time (E-D)
- NC — Normally Closed
- NO — Normally Open

Fig. 14 — Program Timer Sequence

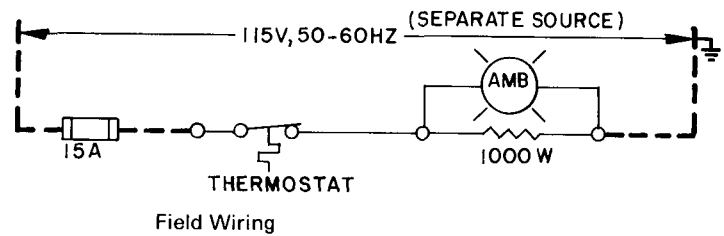
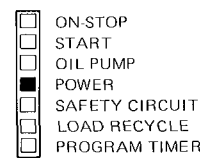

Fig. 15 — Oil Heater Wiring Schematic

- a. POWER light goes on.



- b. Relays KM and KB (lines 10 and 12) are energized thru normally closed contact of machine ON-STOP switch (line 11) and the motor and bearing temperature sensors.
2. Press water pump start button (line 1).
    - a. Pilot relay PR (line 3) energizes starters for water pumps and cooling tower fans. PR contact (line 2) holds relay in.
    - b. Water flow switches (line 17) close.
  3. Press machine ON-STOP button.
    - a. Relays KM and KB remain energized thru KM contact (line 10) and KB contact (line 11). Circuit is completed thru cooler refrigerant low-temperature cutout, condenser high-pressure cutout and compressor motor overloads (line 14), and thru the chilled water recycle switch (line 20).

- b. Oil low-pressure switch and water flow switches (line 17) are temporarily bypassed thru program timer switch PT-4 (line 16).
- c. ON-STOP, SAFETY CIRCUIT and LOAD RECYCLE lights go on.

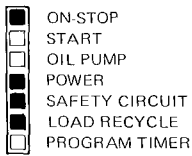

4. Press machine START button.

- a. Relay K1 (line 16) is energized and is held in by its holding contact. Second K1 contact (line 20) closes circuit to program timer motor PT (line 27).
- b. START and PROGRAM TIMER lights go on.

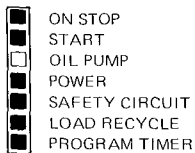

- 5. Program timer switch PT-1 moves to NO position (line 27). Timer motor is kept energized thru ICR NC contact.

- 6. PT-2 moves to NC position (line 5).
  - a. Power reaches oil pump starter M3.
  - b. OIL PUMP light goes on.

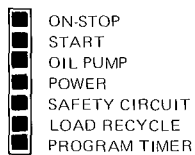

- c. Oil pressure builds up. Pressure switch contacts (lines 17 and 20) close. Guide-vane-close oil pressure switch (line 25) closes.
- d. Relay K2 (line 25) is energized thru the vane closed switch and the guide-vane-close oil pressure switch. K2 contact (line 26) holds in the K2 relay. Second K2 contact (line 35) opens to remove CLOSE signal from guide vane actuator. Third contact in the actuator OPEN circuit (line 36) closes. K2 indicating light goes on.

- 7. In 15 seconds, contact PT-4 (line 16) moves to the NC position and the safety circuit is now completed thru the flow switches, oil low-pressure switch and M3 contact (line 17).

- 8. PT-3 moves to the NC position 13 seconds later. Compressor motor start relay ICR is energized thru the K2 holding contact (line 26). Compressor starts.

- a. Normally open ICR contact (line 20) closes to hold in ICR relay.
- b. Normally closed ICR contact (line 27) opens; program timer stops and PROGRAM TIMER light goes out.

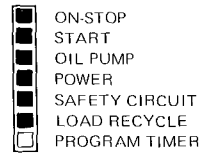

9. Compressor reaches run condition.

- a. Run contact (line 29) closes.
- b. Relay K3, oil cooler solenoid valve and capacity control module are energized.
- c. Normally open K3 contacts (lines 3 and 4) close to interlock oil pump, water pumps and cooling tower fans with compressor motor.
- d. The K2 and K3 contacts (line 36) are now closed and allow an OPEN signal to reach the guide vane actuator.

**Typical Control Sequence — Machine Stop (See Fig. 16.)**

- 1. Push machine ON-STOP switch.
  - a. Machine control relays K1 and K2, and motor start relay ICR are de-energized.
  - b. As ICR relays drop out, compressor stops, ICR contact (line 27) closes and program timer starts. Run contact (line 29) opens and de-energizes relay K3.
  - c. As K3 relay drops out, its contacts (lines 3 and 4) open and remove the interlocking circuit to water pumps, cooling tower fans and oil pump starter. Pumps and fan remain energized thru PR contact (line 2); oil pump remains energized thru PT-2 (line 5).
  - d. A third K3 contact (line 36) and both K2 contacts in the vane actuator circuit return to the de-energized condition and the guide vanes close.
  - e. ON-STOP, START, SAFETY CIRCUIT and LOAD RECYCLE lights go off. PROGRAM TIMER light goes on.

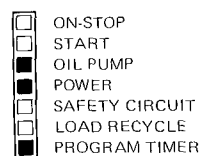

- 2. In a few seconds, PT-3 moves to its NO position, preventing compressor start relay from being energized for 15 minutes.
- 3. Oil pump stops approximately 40 seconds after ON-STOP button is pushed when PT-2 moves to its NO position. OIL PUMP light goes off.

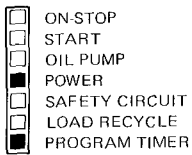

4. In approximately 15 minutes after compressor stop, PT-1 moves to its NC position. Program timer stops, PROGRAM TIMER light goes out and machine can be restarted.

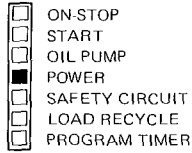

5. Water pumps and cooling tower fans are stopped by pushing water pump stop button (line 1).

**Typical Control Sequence — Machine Recycle**  
 — During normal cooling, the building load may drop low enough to make continuous operation of the refrigeration machine unnecessary. When the chilled water temperature reaches its low cutout point, the machine will shut off automatically. It will remain off for a minimum of 15 minutes and until the rise in chilled water temperature closes the switch contacts. The machine will then restart automatically.

1. Machine operating normally

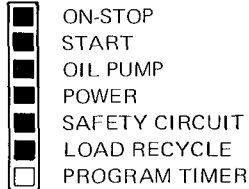

2. Low chilled water temperature cutout opens.  
 Relay 1CR is de-energized.  
 Compressor stops  
 Program timer starts.

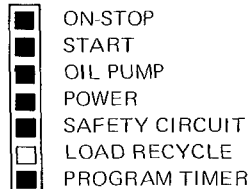

3. Oil pump stops approximately 40 seconds after compressor



4. Chilled water temperature rises and low chilled water temperature cutout closes.



5. Program timer completes its cycle; machine restarts automatically (15 minutes from stop to start)

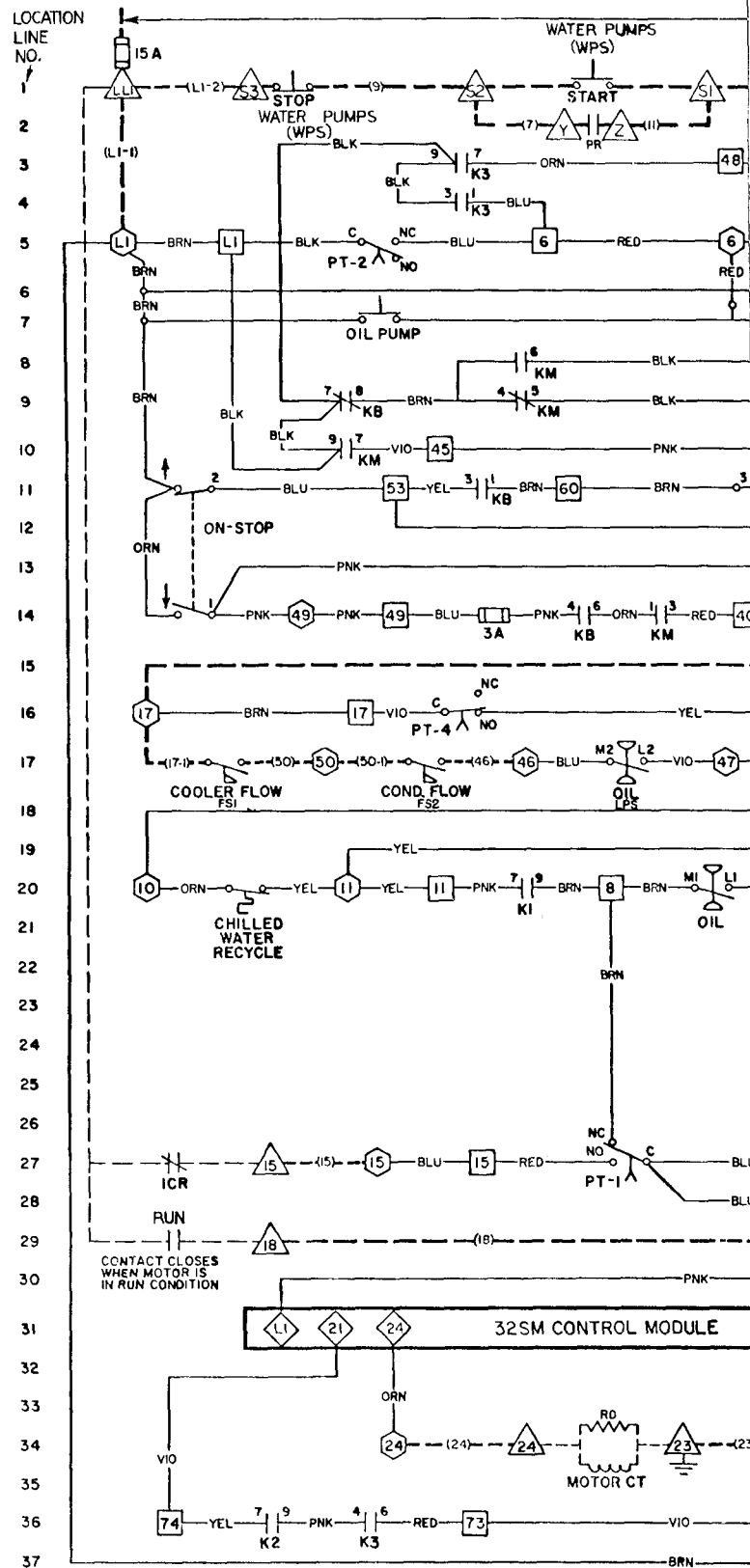
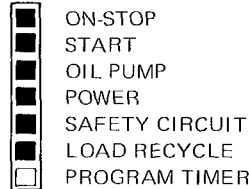

---(---) Field Wiring  
 - - - - Starter Wiring  
 \_\_\_\_\_ Factory Wiring  
 \_\_\_\_\_ Printed Circuit

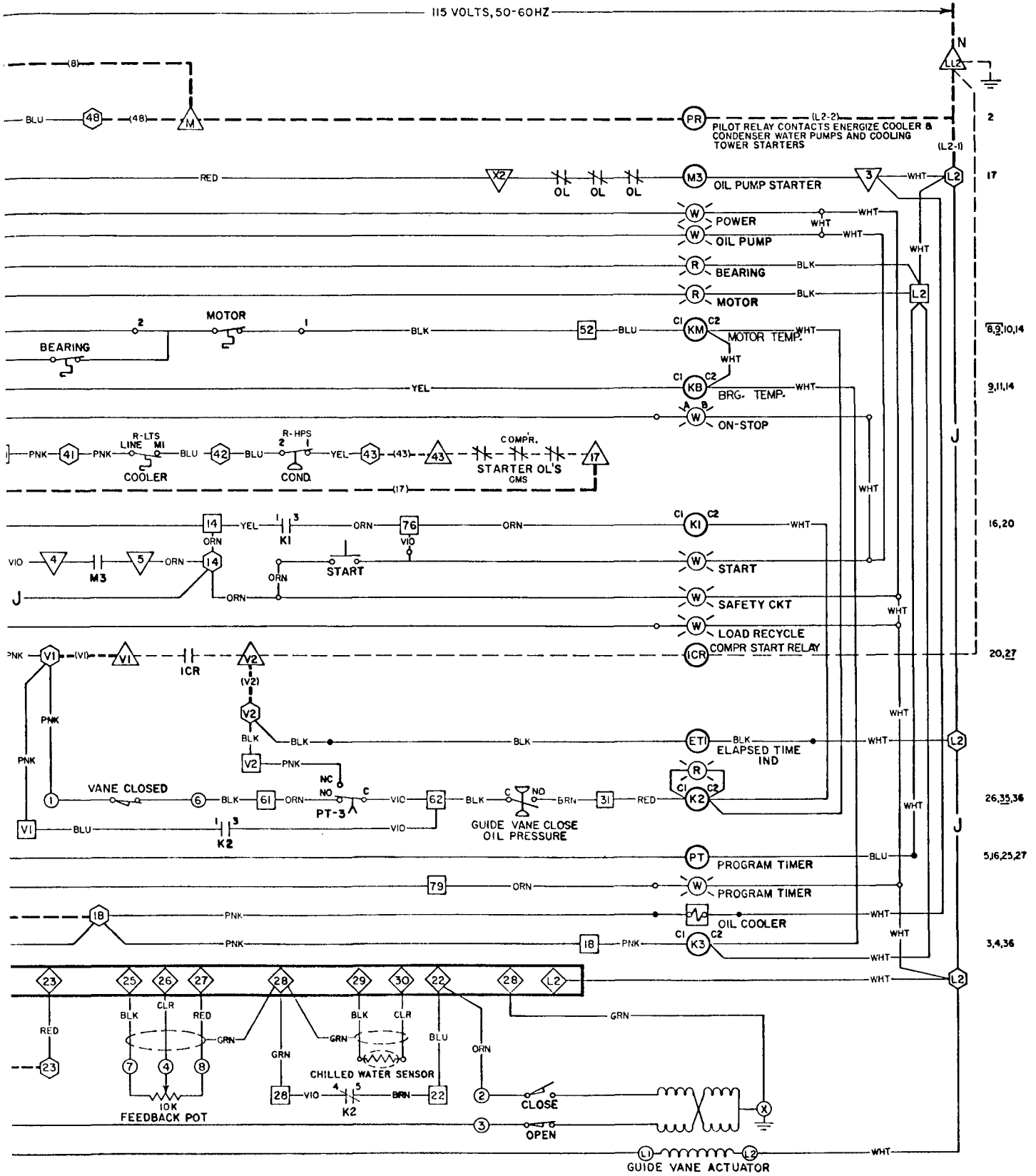

- Field Wiring Terminal
- Relay Module Terminal
- △ Starter Terminal
- Guide Vane Actuator Terminal
- ◇ Capacity Control Module Terminal

J. 16 — Machine Control Wiring Schematic

## CONTROL OPTIONS

**General** — This section presents a brief description of the more common optional controls and their operation. Installation and calibration of optional controls are covered in the instructions accompanying each accessory package. Your nearest Carrier office can provide you with this information if required.

**Remote Thermostat** — This set point control permits selection and alteration of the leaving chilled water temperature from a central station or other location of the customer's choice.

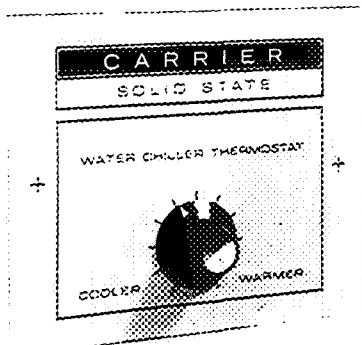

**Lead-Lag Control** provides centralized control of 2 refrigeration machines. Control may be applied to parallel machines, series machines with a common control point or series machines with a split control point.

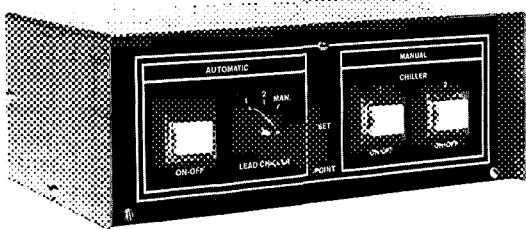

**PREPARATION** — On initial start only, push the ON-STOP and START buttons (lights go on) at each control center. Machine start and stop can now be made at the lead-lag control.

**AUTOMATIC OPERATION** — When the lead-lag ON-OFF button at the left side of the control is pushed and lighted, the chillers, water pumps and tower fans will start and stop automatically in response to a field-supplied outside-air thermostat or other device. The transfer switch permits selection of either machine for part-load recycle.

**MANUAL OPERATION** — With the transfer switch at MAN. position, either or both chillers may be stopped or started manually by pushing the ON-OFF buttons at the right side of the control.

**Safety Indicator Panel** provides "first out" indication for each of the 7 machine safety controls listed below, plus the sounding or lighting of an optional remote alarm.

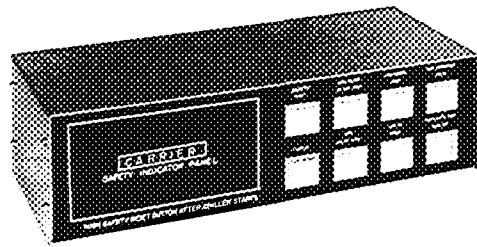

First-out indication is given for:

1. High motor or bearing temperature
2. Low refrigerant temperature
3. High condenser pressure
4. Motor overload
5. Insufficient water flow (cooler and condenser)
6. Low oil pressure
7. Low chilled water temperature

**SETTING INDICATOR PANEL** — After refrigeration machine has been started, press the panel SAFETY RESET button. Panel is now in ready condition.

The SAFETY RESET button is equipped with a light. Light goes out when button is pressed and panel is reset.

All lights remain off until machine shuts down on a safety cutout. The indicator lamp for that particular safety then lights and (except for LOAD RECYCLE/AUTO. OFF lamp) remains lit until the panel is reset. The LOAD RECYCLE/AUTO. OFF lamp goes out when chilled water temperature rises and the switch remakes.

### RESETTING INDICATOR PANEL

1. Correct the condition which caused the safety tripout (except low chilled water temperature).
2. Reset the safety control if manual reset.
3. Restart the refrigeration machine.
4. Press indicator panel SAFETY RESET button.

**PRESS-TO-TEST FEATURE** — To check the condition of any of the indicator lamps, merely press the lamp button. The lamp should light. A burned out lamp does not affect the operation of the alarm circuit. This lamp test does not in any way indicate whether the safety control itself is tripped or not.

If an alarm has been added to the panel, it will sound and/or light while the LOW OIL PRESSURE button is pressed.

**Autostart Control** — Automatic machine and auxiliary start and stop in response to an outside-air thermostat, time clock or other customer-supplied device is available as a modification to the refrigeration machine starter. Figure 17 shows a typical autostart circuit. For application of this circuit to machine control system, refer to your Job Wiring Data.

## INSTRUCTING THE OPERATOR

Be sure that the operator understands all operating instructions. Point out the various machine parts and explain their function within the system.

**Compressor-Motor Assembly** — guide vanes, vane motor and linkage, refrigerant cooling system.

**Unishell Cooler-Condenser** — flow chamber, sight glasses, thermowells, relief devices, charging valve.

**Purge System** — sight glasses, gage, valves and system operation, importance of purge.

**Lubrication System** — oil pump, starter, cooler, filter, heater, thermostat, temperature and pressure gages, pressure regulating valve, solenoid valve, plug valve, operating levels and temperatures.

**Control System** — indicating lights, gages, adjustment of safety and operating controls, auxiliary and special controls.

**Auxiliary Equipment** — starters, pumps, cooling tower.

**Review Maintenance** — importance of log sheet, water treatment.

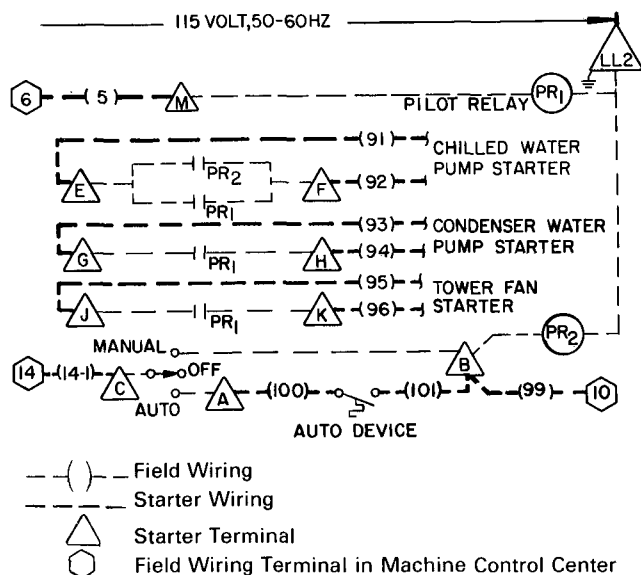
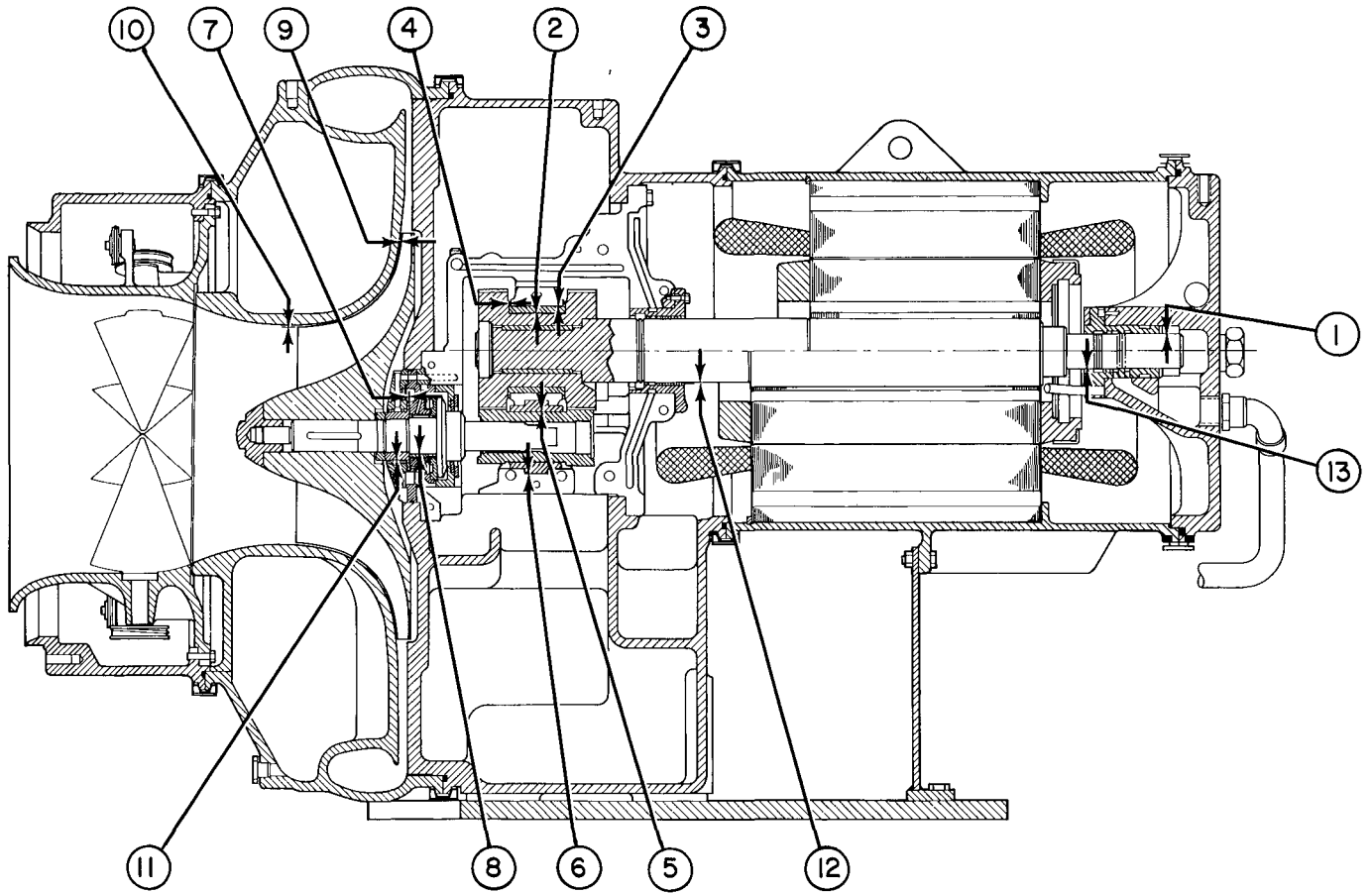

**Fig. 17 — Autostart Connection Diagram (Typical)**

**Table for Fig. 18**

ITEM	DESCRIPTION	COMPR SIZE*	CLEARANCE				TYPE OF MEASURE
			Minimum		Maximum		
			in.	mm	in.	mm	
1	Motor End Bearing	11	.0015	.038	.0030	.076	Diam
		21					
		31					
2	Gear Journal Bearing	11	.0025	.064	.0040	.102	Diam
		21					
		31					
3	Driving Gear Bearing to Housing	11	.0005	.013	.0025	.063	Diam
		21					
		31					
4	Thrust Clearance on Gear Bearing (each side)	11	.010	.254	.018	.460	Axial
		21					
		31					
5	Pinion Gear Journal Bearing	11	.0020	.051	.0035	.088	Diam
		21					
		31					
6	Pinion Gear Bearing to Housing	11	.001	.025	.003	.076	Diam
		21					
		31					
7	Thrust Bearing	11	.008	.203	.014	.356	Axial
		21					
		31					
8	High Speed Journal Bearing	11	.0010	.026	.0025	.063	Diam
		21					
		31					
9	Front of Impeller to Volute Wall	11	.032	.810	.036	.910	Axial
		21					
		31					
10	Impeller Eye to ID of Inlet Ring	11	.017	.430	.035	.890	Radius
		21					
		31					
11	Labyrinth Behind Impeller to Spacer Ring	11	.007	.178	.011	.279	Diam
		21					
		31					
12	Labyrinth Behind Transmission and Motor Shell	11	.006	.152	.010	.254	Diam
		21					
		31					
13	End-Bell Bearing Labyrinth	11	.0045	.114	.0070	.178	Diam
		21					
		31					

\*Refer to Model Number on compressor nameplate



**Fig. 18 — Compressor Fits and Clearances**

**Table 3 — Machine Charge**

UNISHELL SIZE	MACHINE CHARGE			
	Refrig (R-11)		Water	
	lb	kg	lb	kg
42	500	227	360	163
44	525	238	380	172
46	550	249	420	191
50	575	261	530	240
51	575	261	560	254
53	600	272	600	272
55	625	283	635	288
57	625	283	690	313
61	775	352	985	447
63	810	367	1030	467
65	850	386	1120	508
71	975	442	1140	517
72	985	447	1190	540
73	1010	458	1250	567
76	1100	499	1400	635
77	1150	522	1520	689
78	1200	544	1630	739

For replacement items use Carrier Specified Parts.

Manufacturer reserves the right to discontinue, or change at any time, specifications or designs without notice and without incurring obligations

Book	2
Tab	5a

Form 19DK-1SSM New

Printed in U S A

5-82

PC 211

Catalog No 531-912