

## E7 Drive User Manual

*This Manual  
also available on  
[www.drives.com](http://www.drives.com)*



Model: E7U

Document Number: TM.E7.01

## Quick Reference for E7 Parameters

Parameter Number	Factory Setting	User Setting	Parameter Number	Factory Setting	User Setting	Parameter Number	Factory Setting	User Setting	Parameter Number	Factory Setting	User Setting
A1-00	0		b5-07	0		E1-07	3		L4-02	2	
A1-01	2		b5-08	0		E1-08	18		L4-05	1	
A1-03	0		b5-09	0		E1-09	1.5		L4-06	80	
A1-04	0		b5-10	1		E1-10	10.8		L5-01	0	
A1-05	0		b5-11	0		E1-11	0		L5-02	0	
A2-01			b5-12	0		E1-12	0		L5-03	180	
A2-02			b5-13	0		E1-13	0		L6-01	6	
A2-03			b5-14	1		E2-01	kVA Dep.		L6-02	15	
A2-04			b5-15	0		E2-03	kVA Dep.		L6-03	10	
A2-05			b5-16	0		E2-05	kVA Dep.		L8-01	0	
A2-06			b5-17	0		F6-01	1		L8-02	kVA Dep.	
A2-07			b5-18	0		F6-02	0		L8-03	4	
A2-08			b5-19	0		F6-03	1		L8-06	kVA Dep.	
A2-09			b5-20	1		F6-05	0		L8-09	1	
A2-10			b5-21	1		H1-01	24		L8-10	0	
A2-11			b5-22	0		H1-02	14		L8-11	300	
A2-12			b5-23	0		H1-03	3		L8-12	45	
A2-13			b5-24	0		H1-04	4		L8-15	1	
A2-14			b5-25	0		H1-05	6		L8-18	1	
A2-15			b5-26	0		H2-01	0		L8-19	20	
A2-16			b5-27	60		H2-02	A		n1-01	1	
A2-17			b5-28	0		H3-02	100		n1-02	1	
A2-18			b5-29	1		H3-03	0		n3-01	5	
A2-19			b5-30	0		H3-08	2		n3-02	150	
A2-20			b8-01	0		H3-09	2		n3-03	1	
A2-21			b8-04	kVA Dep.		H3-10	100		n3-04	40	
A2-22			b8-05	20		H3-11	0		o1-01	6	
A2-23			b8-06	0		H3-12	0.3		o1-02	1	
A2-24			C1-01	30		H3-13	0		o1-03	0	
A2-25			C1-02	30		H4-01	2		o1-05	3	
A2-26			C1-03	30		H4-02	100		o1-06	0	
A2-27			C1-04	30		H4-03	0		o1-07	2	
A2-28			C1-09	10		H4-04	8		o1-08	3	
A2-29			C1-11	0		H4-05	50		o2-01	1	
A2-30			C2-01	0.2		H4-06	0		o2-02	1	
A2-31			C2-02	0.2		H4-07	0		o2-03	0	
A2-32			C4-01	1		H4-08	0		o2-04	kVA Dep.	
b1-01	1		C4-02	200		H5-01	1F		o2-05	1	
b1-02	1		C6-01	2		H5-02	3		o2-06	1	
b1-03	0		C6-02	kVA Dep.		H5-03	0		o2-07	0	
b1-04	1		C6-03	kVA Dep.		H5-04	3		o2-08	1	
b1-07	0		C6-04	kVA Dep.		H5-05	1		o2-09	1	
b1-08	0		C6-05	0		H5-06	5		o2-10	0	
b1-11	0		d1-01	0		H5-07	1		o2-12	0	
b1-12	0		d1-02	0		H5-08	0		o2-14	0	
b2-01	0.5		d1-03	0		H5-09	2		o2-15	1	
b2-02	50		d1-04	0		L1-01	1		o3-01	0	
b2-03	0		d1-17	6		L1-02	8		o3-02	0	
b2-04	0		d2-01	100		L1-03	3		T1-02	kVA Dep.	
b2-09	0		d2-02	0		L1-04	1		T1-04	kVA Dep.	
b3-01	2		d2-03	0		L1-05	0.2				
b3-02	120		d3-01	0		L2-01	2				
b3-03	2		d3-02	0		L2-02	kVA Dep.				
b3-05	0.2		d3-03	0		L2-03	kVA Dep.				
b3-14	1		d3-04	1		L2-04	kVA Dep.				
b4-01	0		d4-01	0		L2-05	Voltage Dep.				
b4-02	0		d4-02	10		L3-01	1				
b5-01	0		E1-01	240V or 480V		L3-02	120				
b5-02	2		E1-03	F		L3-04	1				
b5-03	5		E1-04	60		L3-05	1				
b5-04	100		E1-05	240V or 480V		L3-06	120				
b5-06	100		E1-06	60		L4-01	0				

# Warnings and Cautions

---

*This Section provides warnings and cautions pertinent to this product, that if not heeded, may result in personal injury, fatality, or equipment damage. Yaskawa is not responsible for consequences of ignoring these instructions.*

## **WARNING**

YASKAWA manufactures component parts that can be used in a wide variety of industrial applications. The selection and application of YASKAWA products remain the responsibility of the equipment designer or end user. YASKAWA accepts no responsibility for the way its products are incorporated into the final system design. Under no circumstances should any YASKAWA product be incorporated into any product or design as the exclusive or sole safety control. Without exception, all controls should be designed to detect faults dynamically and fail safely under all circumstances. All products designed to incorporate a component part manufactured by YASKAWA must be supplied to the end user with appropriate warnings and instructions as to that part's safe use and operation. Any warnings provided by YASKAWA must be promptly provided to the end user. YASKAWA offers an express warranty only as to the quality of its products in conforming to standards and specifications published in the YASKAWA manual. **NO OTHER WARRANTY, EXPRESS OR IMPLIED, IS OFFERED.** YASKAWA assumes no liability for any personal injury, property damage, losses, or claims arising from misapplication of its products.

## **WARNING**

- Read and understand this manual before installing, operating, or servicing this Drive. All warnings, cautions, and instructions must be followed. All activity must be performed by qualified personnel. The Drive must be installed according to this manual and local codes.
- Do not connect or disconnect wiring while the power is on. Do not remove covers or touch circuit boards while the power is on. Do not remove or insert the digital operator while power is on.
- Before servicing, disconnect all power to the equipment. The internal capacitor remains charged even after the power supply is turned off. Status indicator LEDs and Digital Operator display will be extinguished when the DC bus voltage is below 50 VDC. To prevent electric shock, wait at least five minutes after all indicators are OFF and measure DC bus voltage level to confirm safe level.
- Do not perform a withstand voltage test on any part of the unit. This equipment uses sensitive devices and may be damaged by high voltage.
- The Drive is not suitable for circuits capable of delivering more than the specified RMS symmetrical amperes. Install adequate branch short circuit protection per applicable codes. Refer to the specification. Failure to do so may result in equipment damage and/or personal injury.
- Do not connect unapproved LC or RC interference suppression filters, capacitors, or overvoltage protection devices to the output of the Drive. These devices may generate peak currents that exceed Drive specifications.
- To avoid unnecessary fault displays caused by contactors or output switches placed between Drive and motor, auxiliary contacts must be properly integrated into the control logic circuit.
- YASKAWA is not responsible for any modification of the product made by the user; doing so will void the warranty. This product must not be modified.
- Verify that the rated voltage of the Drive matches the voltage of the incoming power supply before applying power.
- To meet CE directives, proper line filters and proper installation are required.

 **WARNING**

- Some drawings in this manual may be shown with protective covers or shields removed, to describe details. These must be replaced before operation.
- Observe electrostatic discharge procedures when handling circuit cards to prevent ESD damage.
- The equipment may start unexpectedly upon application of power. Clear all personnel from the drive, motor, and machine area before applying power. Secure covers, couplings, shaft keys, and machine loads before energizing the Drive.
- Please do not connect or operate any equipment with visible damage or missing parts. The operating company is responsible for any injuries or equipment damage resulting from failure to heed the warnings in this manual.

### ■ Intended Use

Drives are intended for installation in electrical systems or machinery.

For use in the European Union, the installation in machinery and systems must conform to the following product standards of the Low Voltage Directive:

EN 50178, 1997-10, Equipping of Power Systems with Electronic Devices

EN 60201-1, 1997-12 Machine Safety and Equipping with Electrical Devices

Part 1: General Requirements (IEC 60204-1:1997)/

EN 61010, 1997-11 Safety Requirements for Information Technology Equipment

(IEC 950:1991 + A1:1992 + A2:1993 + A3:1995 + A4:1996, modified)

CE certification per EN 50178 can be achieved using the line filters specified in this manual and following the appropriate installation instructions.

### ■ Other

The E7 Drive is suitable for use on a circuit capable of delivering not more than 100,000 RMS symmetrical amperes, 240Vac maximum (240V Class) and 480Vac maximum (480V Class).

# Introduction

*This Section describes the applicability of the Manual*

The E7 Drive is a Pulse Width Modulated Drive for 3-Phase AC induction motors. This type of Drive is also known as an Adjustable Frequency Drive, Variable Frequency Drive, AC Drive, AFD, ASD, VFD, and Inverter. In this manual, the E7 Drive will be referred to as the “Drive”.

The E7 Drive is a variable torque AC drive, designed specifically for HVAC applications in building automation, including fans, blowers and pumps. A new benchmark for size, cost, performance, benefits, and quality, the E7 includes numerous built-in features such as network communications, H/O/A, PI, parameter storage and copy functions.

The E7 has embedded communications for the popular building automation protocols, Johnson Controls Metasys® and Siemens APOGEE™ FLN, as well as Modbus®. An optional LONWORKS® interface card is also available.

The LCD keypad/operator is equipped with Hand/Off/Auto functions, copy feature, 7 language choices, and 5 lines of display with 16 characters per line. User parameter settings can be recovered at any time via “user initialization”. Optional software allows upload/download, as well as graphing and monitoring of drive parameters from a PC for ease of drive management.

Built-in PI control eliminates the need for closed loop output signals from a building automation system. It includes feedback display, inverse, square root and differential control functions, and maintains setpoint for closed loop control of fans and pumps for pressure, flow, or temperature regulation.

This manual is applicable to E7 Drives defined by model numbers CIMR-E7U\_ \_ \_ \_ . This manual reflects the Software Version 3020.

This manual is subject to change as product improvements occur. The latest version of the manual can be obtained from the Yaskawa website [www.drives.com](http://www.drives.com) . The date shown on the rear cover is changed when revisions are made. The latest version of Drive software is also shown.

This manual may describe trademarked equipment, which is the property of other companies. These trademarks are the property of the registered owner companies and may include the following:

APOGEE™ FLN, trademark of Siemens Building Technologies, Inc.

Metasys®, trademark of Johnson Controls Inc.

Modbus®, trademark of Schneider Automation, Inc.

LONWORKS®, trademark of Echelon Corporation

Other Documents and Manuals are available to support special use or installation of this product. These documents may be provided with the product or upon request. Contact Yaskawa Electric America, Inc. as required. Documents may include the following:

TM.E7.02.Programming... Manual included on CD ROM with product

TM.E7.11.Modbus... Manual included on CD ROM with product

TM.E7.20.LONWORKS... Manual included on CD ROM with product

TM.E7.21.APOGEE ... Manual included on CD ROM with product

TM. E7.22. Metasys... Manual included on CD ROM with product

TM.E7B.01. Bypass... This manual should be used when the E7 Drive is packaged with Bypass Control

DriveWizard ... Software and Manual...Included on CD ROM with product

Option Instructions... Included on CD ROM with product

# Table of Contents

---

Quick Reference Parameter List .....	Inside front cover
Warnings and Cautions .....	i
Introduction .....	iii

## **Chapter 1- Physical Installation .....1-1**

E7 Model Number and Enclosure Style .....	1-2
Confirmations Upon Delivery .....	1-3
Component Names .....	1-5
Exterior and Mounting Dimensions .....	1-7
Heat Loss Data .....	1-11
Checking and Controlling the Installation Site.....	1-13
Installation Orientation and Clearances .....	1-14
Removing and Attaching the Terminal Cover.....	1-15
Removing/Attaching the Digital Operator and Front Cover.....	1-16

## **Chapter 2- Electrical Installation.....2-1**

Terminal Block Configuration .....	2-2
Wiring Main Circuit Terminals.....	2-3
Control Wiring .....	2-12

## **Chapter 3- Digital Operator.....3-1**

Digital Operator Display .....	3-2
Digital Operator Keys .....	3-3
Drive Mode Indicators .....	3-5
Drive Main Menu .....	3-7
Quick Setting Menu (-QUICK-).....	3-12
Programming Menu (-ADV-).....	3-13
Example of Changing a Parameter .....	3-15

<b>Chapter 4- Start Up</b> .....	<b>4-1</b>
Drive Start Up Preparation .....	4-2
Drive Start Up Procedures .....	4-5
<b>Chapter 5- Basic Programming</b> .....	<b>5-1</b>
A1 Initialization.....	5-2
b1 Sequence.....	5-4
b2 DC Braking.....	5-9
b3 Speed Search .....	5-11
b5 PI Function.....	5-15
b8 Energy Savings.....	5-24
C1 Accel/Decel.....	5-25
d2 Reference (Speed Command) Limits.....	5-26
d3 Jump Frequencies.....	5-27
E1 V/f Pattern.....	5-28
E2 Motor Setup .....	5-31
F6 Com OPT Setup.....	5-32
H3 Analog Inputs.....	5-33
L2 Momentary Power Loss Ride-thru Function.....	5-39
L3 Stall Prevention .....	5-40
L4 Speed Command Loss Detection.....	5-43
L5 Fault Restart.....	5-44
L6 Torque Detection .....	5-46
L8 Hardware Protection .....	5-48
o1 Monitor Configuration.....	5-50
o2 Key Selections .....	5-54
o3 Digital Operator Copy Function.....	5-56
T1 Auto-Tuning .....	5-59
<b>Chapter 6- Diagnostic &amp; Troubleshooting</b> .....	<b>6-1</b>
Fault Detection.....	6-2
Alarm Detection.....	6-8
Operator Programming Errors (OPE).....	6-11

Auto-Tuning Faults .....	6-12
Digital Operator COPY Function Faults .....	6-13
Troubleshooting .....	6-14
Main Circuit Test Procedure .....	6-20
Drive Date Stamp Information .....	6-24
<b>Chapter 7- Maintenance .....</b>	<b>7-1</b>
Periodic Inspection.....	7-2
Preventive Maintenance.....	7-3
Heatsink Cooling Fan Replacement.....	7-4
Removing and Mounting the Terminal Card.....	7-6
<b>Appendix A - Parameters .....</b>	<b>A-1</b>
Parameter List.....	A-2
Monitor List.....	A-26
Fault Trace List .....	A-28
Fault Trace History.....	A-29
Decimal to Hex Conversion.....	A-30
<b>Appendix B - Capacity Related Parameters .....</b>	<b>B-1</b>
Drive Capacity.....	B-2
Parameters Affected by o2-04 .....	B-3
<b>Appendix C - Specifications .....</b>	<b>C-1</b>
Standard Drive Specification .....	C-2

<b>Appendix D - Communication .....</b>	<b>D-1</b>
Using Modbus Communication .....	D-2
Modbus Function Code Details .....	D-7
Modbus Data Tables .....	D-9
Modbus Self- Diagnosis .....	D-14
<b>Appendix E - Peripheral Devices .....</b>	<b>E-1</b>
Branch Circuit Short Circuit Protection.....	E-2
Branch Circuit Overload Protection.....	E-5
Peripheral Devices .....	E-6
<b>Appendix F - Spare Parts .....</b>	<b>F-1</b>
E7 Primary Spare Parts - 208/230/240VAC .....	F-2
E7 Primary Spare Parts - 480VAC .....	F-3
<b>Appendix G - EMC Compatibility .....</b>	<b>G-1</b>
EMC Compatibility.....	G-2
Electromagnetic Compatibility (EMC) .....	G-3
Index .....	Index-1
Support Services .....	Inside rear cover

# Chapter 1

## Physical Installation

---

*This chapter describes the requirements for receiving and installing the E7 Drive.*

E7 Model Number and Enclosure Style .....	1-2
Confirmations upon Delivery .....	1-3
Component Names.....	1-5
Exterior and Mounting Dimensions.....	1-7
Heat Loss Data .....	1-11
Checking and Controlling the Installation Site .....	1-13
Installation Orientation and Clearances.....	1-14
Removing and Attaching the Terminal Cover .....	1-15
Removing/Attaching the Digital Operator and Front Cover.....	1-16

# E7 Model Number and Enclosure Style

Table 1.1 E7 Model Numbers and Enclosure Style				
Input Voltage 3-Phase	E7 Model Number	Enclosure Style	Rated Output Current	Nominal Hp
208-240Vac	CIMR-E7U20P4	NEMA Type 1 (IP20)	3.6	0.5/0.75
	CIMR-E7U20P7	NEMA Type 1 (IP20)	4.6	1
	CIMR-E7U21P5	NEMA Type 1 (IP20)	7.8	1.5/2
	CIMR-E7U22P2	NEMA Type 1 (IP20)	10.8	3
	CIMR-E7U23P7	NEMA Type 1 (IP20)	16.8	5
	CIMR-E7U25P5	NEMA Type 1 (IP20)	23.0	7.5
	CIMR-E7U27P5	NEMA Type 1 (IP20)	31.0	7.5/10
	CIMR-E7U2011	NEMA Type 1 (IP20)	46.2	15
	CIMR-E7U2015	NEMA Type 1 (IP20)	59.4	20
	CIMR-E7U2018	NEMA Type 1 (IP20)	74.8	25
	CIMR-E7U2022	NEMA Type 1 (IP20)	88.0	30
	CIMR-E7U2030	NEMA Type 1 (IP20)	115.0	40
208-230Vac	CIMR-E7U2037	Open Chassis (IP00)	162.0	50/60
	CIMR-E7U2045	Open Chassis (IP00)	192.0	60/75
	CIMR-E7U2055	Open Chassis (IP00)	215.0	75
	CIMR-E7U2075	Open Chassis (IP00)	312.0	100/125
	CIMR-E7U2090	Open Chassis (IP00)	360.0	125/150
	CIMR-E7U2110	Open Chassis (IP00)	415.0	150
480Vac	CIMR-E7U40P4	NEMA Type 1 (IP20)	1.8	0.5/0.75
	CIMR-E7U40P7	NEMA Type 1 (IP20)	2.1	1
	CIMR-E7U41P5	NEMA Type 1 (IP20)	3.7	1.5/2
	CIMR-E7U42P2	NEMA Type 1 (IP20)	5.3	3
	CIMR-E7U43P7	NEMA Type 1 (IP20)	7.6	5
	CIMR-E7U45P5	NEMA Type 1 (IP20)	12.5	7.5
	CIMR-E7U47P5	NEMA Type 1 (IP20)	17.0	10
	CIMR-E7U4009	NEMA Type 1 (IP20)	21.0	15
	CIMR-E7U4011	NEMA Type 1 (IP20)	27.0	20
	CIMR-E7U4015	NEMA Type 1 (IP20)	34.0	25
	CIMR-E7U4018	NEMA Type 1 (IP20)	40.0	30
	CIMR-E7U4024	NEMA Type 1 (IP20)	52.0	40
	CIMR-E7U4030	NEMA Type 1 (IP20)	67.2	50
	CIMR-E7U4037	NEMA Type 1 (IP20)	77.0	60
	CIMR-E7U4045	NEMA Type 1 (IP20)	96.0	75
	CIMR-E7U4055	NEMA Type 1 (IP20)	125.0	100
	CIMR-E7U4075	Open Chassis (IP00)	156.0	125
	CIMR-E7U4090	Open Chassis (IP00)	180.0	150
	CIMR-E7U4110	Open Chassis (IP00)	240.0	200
	CIMR-E7U4160	Open Chassis (IP00)	304.0	250
CIMR-E7U4185	Open Chassis (IP00)	414.0	300/350	
CIMR-E7U4220	Open Chassis (IP00)	515.0	400/450	
CIMR-E7U4300	Open Chassis (IP00)	675.0	500+	

# Confirmations upon Delivery

## ◆ Receiving Checks

Check the following items as soon as the Drive is received.

Item	Method
Has the correct model of Drive been delivered?	Check the model number on the nameplate on the right side of the Drive. Reconcile with packing slip and/or order information.
Is the Drive damaged in any way?	Inspect the entire exterior of the Drive to see if there are any dents, scratches or other damage resulting from shipping.
Are any screws or other components loose?	Use a screwdriver or other tool to check for tightness.

If there are any irregularities in the above items, contact the shipping company, the distributor or representative who sold the Drive, or a Yaskawa office immediately.

The E7 is thoroughly tested at the factory. Any damages or shortages evident when the equipment is received must be reported immediately to the commercial carrier that transported the material. Shipping damage is not covered by the Yaskawa warranty. After unpacking and inspecting for damage, verify that internal wire connections have not come loose during shipment by spot checking wire terminations with a screwdriver or the appropriate tool.

E7 Drive storage must be in a clean and dry location. Maintain the factory packaging and provide covering as needed to protect the E7 from construction site dirt, water, debris and traffic prior to and during construction.

## ◆ Nameplate Information

A nameplate is attached to the right side of each Drive. The following nameplate is an example for a standard Drive.



Note: The Drive Model Number and Drive Spec Number are required to completely identify a Drive.

Fig 1.1 E7 Drive Nameplate

## ◆ Drive Model Numbers

The model number on the nameplate indicates the design specification, voltage, and rating of the Drive in alphanumeric codes.

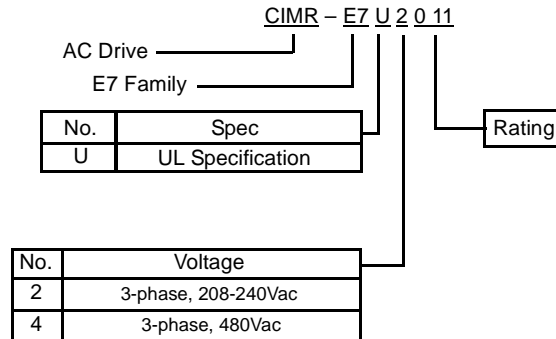

Fig 1.2 Drive Model Number Structure

## ◆ Drive Enclosure and Revision Code

The Drive SPEC number on the nameplate indicates the voltage, Drive rating, enclosure type, and the revision code of the Drive in alphanumeric codes.

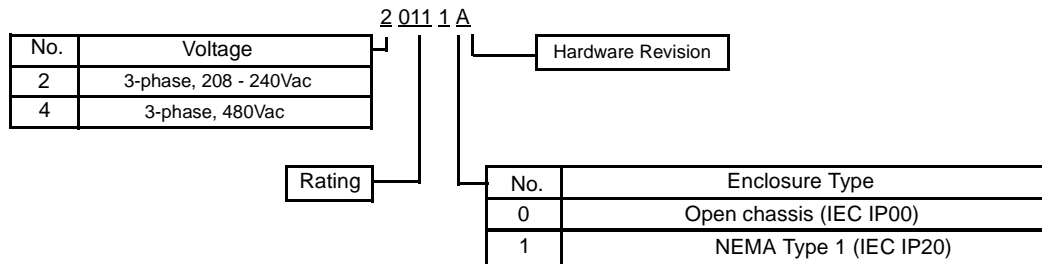

Fig 1.3 SPEC Number Structure

### TERMS

#### Open Chassis Type (IEC IP00)

Protected so that parts of the human body cannot reach electrically charged parts from the front when the Drive is mounted in a control panel, also called (protected chassis).

#### NEMA Type 1 (IEC IP20)

The Drive is shielded from the exterior, and can thus be mounted to the interior wall of a building (not necessarily enclosed in a control panel). The protective structure conforms to the standards of NEMA Type 1 in the USA. All protective covers (Fig 1.4) must be installed to conform with IEC IP20 and NEMA Type 1 requirements.

# Component Names

## ◆ Models CIMR-E7U20P4 thru 2018 (25HP @ 208V/240V) and 40P4 thru 4018 (30HP @ 480V)

The external appearance, component names, and terminal arrangement of the Drive are shown in Fig 1.4. and 1.5.

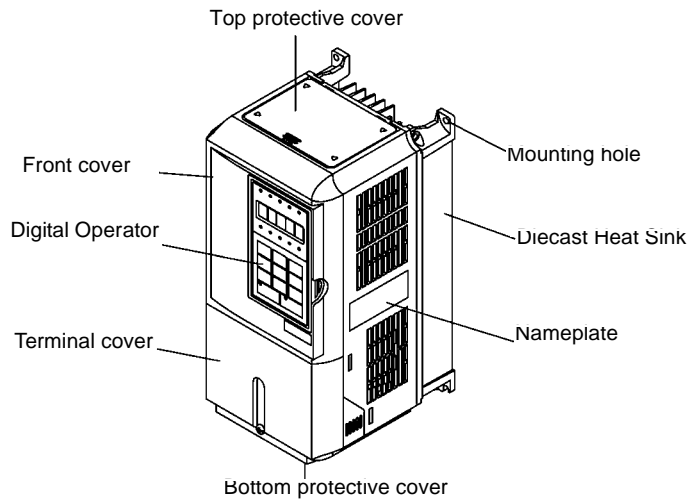

Fig 1.4 Drive Appearance

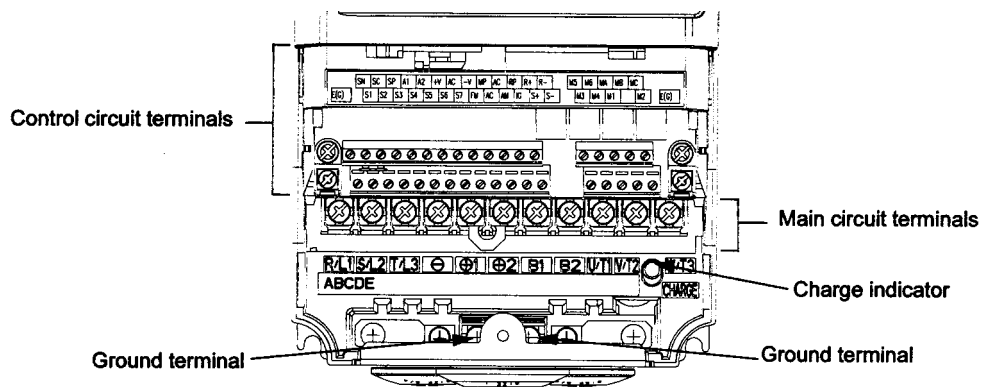

Fig 1.5 Terminal Arrangement (Terminal Cover Removed)

◆ **Models CIMR-E7U2022 thru 2110 (30HP and above @ 208V/240V) and 4030 thru 4300 (40HP and above @ 480V)**

The external appearance, component names, and terminal arrangement of the Drive are shown in Fig 1.6 and 1.7.

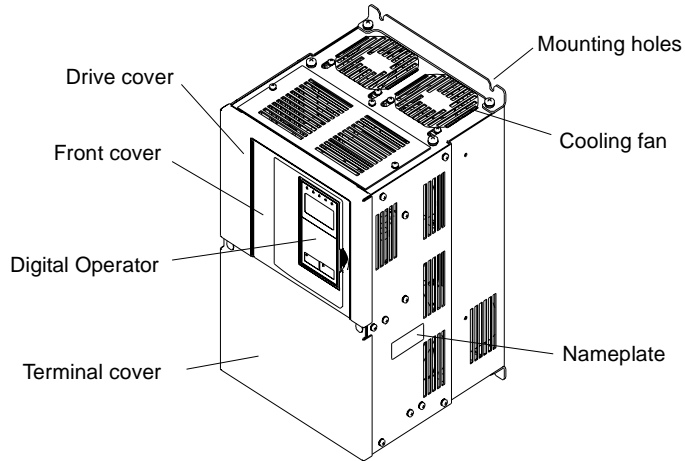

Fig 1.6 Drive Appearance

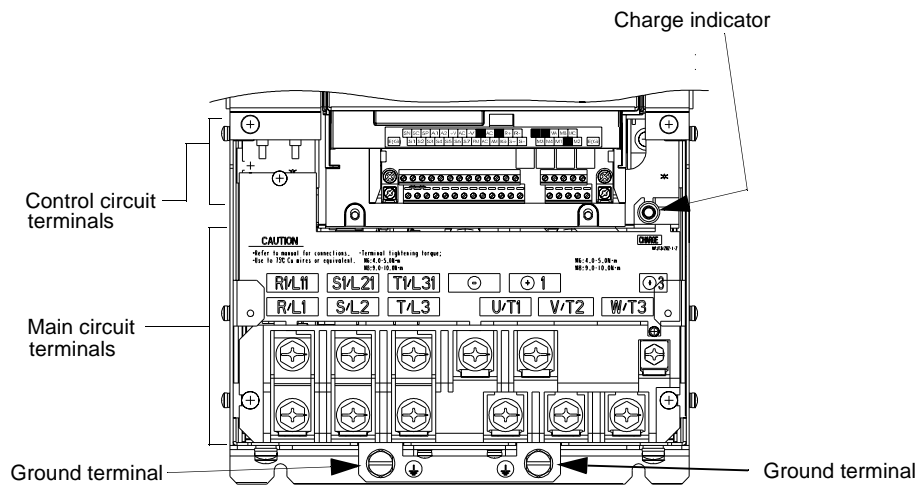
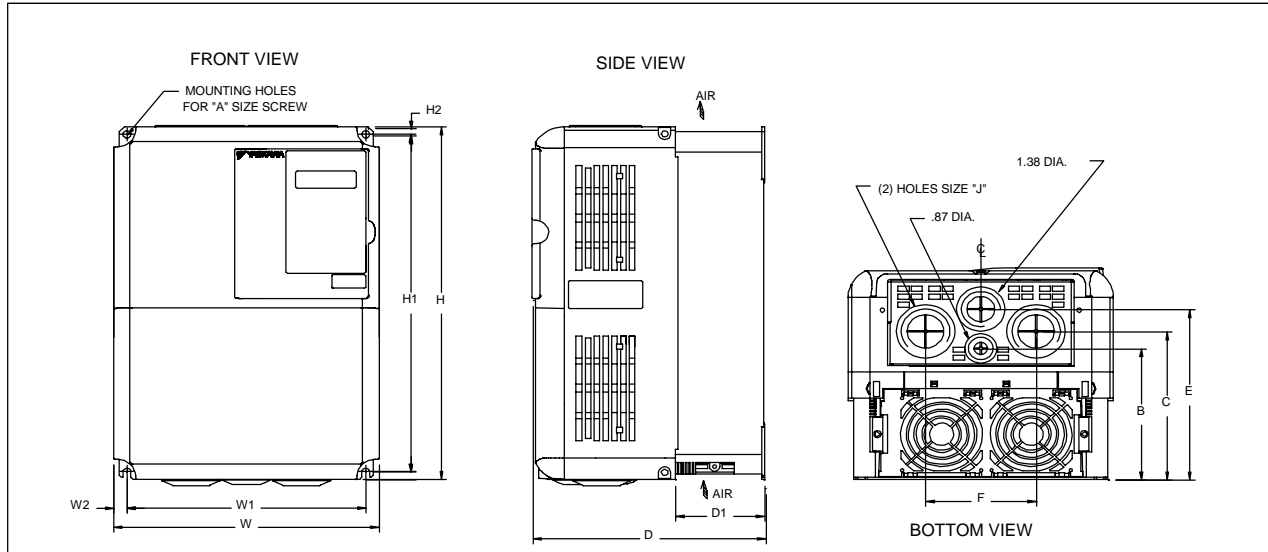

Fig 1.7 Terminal Arrangement (Terminal Cover Removed)

# Exterior and Mounting Dimensions

DIMENSIONS: E7 (NEMA 1) 208/240V (3.6-74.8 AMPS) 480V (1.8- 40.0 AMPS)

S - 5516



RATED INPUT	MODEL CIMR-E7U	RATED OUTPUT CURRENT (AMPS)	NOMINAL HP	DIMENSIONS IN INCHES														APPROX. WEIGHT (LBS.)
				MOUNTING		H	W	H2	W2	D	D1	A	B	C	E	F	J	
				H1	W1													
208V	20P41	3.6	1/2 3/4	10.47	4.96	11.02	5.51	.28	.28	6.30	1.54	#10	---	3.35	4.73	1.97	1.10	6.6
	20P71	4.6	1	10.47	4.96	11.02	5.51	.28	.28	6.30	1.54	#10	---	3.35	4.73	1.97	1.10	6.6
	21P51	7.8	2	10.47	4.96	11.02	5.51	.28	.28	6.30	1.54	#10	---	3.35	4.73	1.97	1.10	6.6
	22P21	10.8	3	10.47	4.96	11.02	5.51	.28	.28	6.30	1.54	#10	---	3.35	4.73	1.97	1.10	6.6
	23P71	16.8	5	10.47	4.96	11.02	5.51	.28	.28	7.09	2.32	#10	---	4.14	5.52	1.97	1.10	8.8
	27P51	31.0	7.5-10	11.22	7.32	11.81	7.87	.28	.28	7.87	2.58	1/4	4.63	5.11	6.21	3.07	1.38	13.2
	20111	46.2	15	11.22	7.32	12.20	7.87	.28	.28	7.87	2.58	1/4	4.63	5.11	6.21	3.07	1.38	15.4
	20151	59.4	20	13.19	8.50	13.78	9.45	.30	.47	8.27	3.07	1/4	5.12	5.79	6.65	3.94	1.73	24.2
	20181	74.8	25	13.19	8.50	14.96	9.45	.30	.47	8.27	3.07	1/4	5.12	5.79	6.65	3.94	1.73	24.2
240V	20P41	3.6	1/2 3/4	10.47	4.96	11.02	5.51	.28	.28	6.30	1.54	#10	---	3.35	4.73	1.97	1.10	6.6
	20P71	4.6	1	10.47	4.96	11.02	5.51	.28	.28	6.30	1.54	#10	---	3.35	4.73	1.97	1.10	6.6
	21P51	7.8	2	10.47	4.96	11.02	5.51	.28	.28	6.30	1.54	#10	---	3.35	4.73	1.97	1.10	6.6
	22P21	10.8	3	10.47	4.96	11.02	5.51	.28	.28	6.30	1.54	#10	---	3.35	4.73	1.97	1.10	6.6
	23P71	16.8	5	10.47	4.96	11.02	5.51	.28	.28	7.09	2.32	#10	---	4.14	5.52	1.97	1.10	8.8
	25P51	23.0	7.5	10.47	4.96	11.02	5.51	.28	.28	7.09	2.32	#10	---	4.14	5.52	1.97	1.10	8.8
	27P51	31.0	10	11.22	7.32	11.81	7.87	.28	.28	7.87	2.58	1/4	4.63	5.11	6.21	3.07	1.38	13.2
	20111	46.2	15	11.22	7.32	12.20	7.87	.28	.28	7.87	2.58	1/4	4.63	5.11	6.21	3.07	1.38	15.4
	20151	59.4	20	13.19	8.50	13.78	9.45	.30	.47	8.27	3.07	1/4	5.12	5.79	6.65	3.94	1.73	24.2
480V	40P41	1.8	1/2 3/4	10.47	4.96	11.02	5.51	.28	.28	6.30	1.54	#10	---	3.35	4.73	1.97	1.10	6.6
	40P71	2.1	1	10.47	4.96	11.02	5.51	.28	.28	6.30	1.54	#10	---	3.35	4.73	1.97	1.10	6.6
	41P51	3.7	2	10.47	4.96	11.02	5.51	.28	.28	6.30	1.54	#10	---	3.35	4.73	1.97	1.10	6.6
	42P21	5.3	3	10.47	4.96	11.02	5.51	.28	.28	7.09	2.32	#10	---	4.14	5.52	1.97	1.10	8.8
	43P71	7.6	5	10.47	4.96	11.02	5.51	.28	.28	7.09	2.32	#10	---	4.14	5.52	1.97	1.10	8.8
	45P51	12.5	7.5	10.47	4.96	11.02	5.51	.28	.28	7.09	2.32	#10	---	4.14	5.52	1.97	1.10	8.8
	47P51	17.0	10	11.22	7.32	11.81	7.87	.28	.28	7.87	2.58	1/4	4.63	5.11	6.21	3.07	1.38	13.2
	40091	21.0	15	11.22	7.32	11.81	7.87	.28	.28	7.87	2.58	1/4	4.63	5.11	6.21	3.07	1.38	13.2
	40111	27.0	20	11.22	7.32	11.81	7.87	.28	.28	7.87	2.58	1/4	4.63	5.11	6.21	3.07	1.38	13.2
	40151	34.0	25	13.19	8.50	13.78	9.45	.30	.47	8.27	3.07	1/4	5.12	5.79	6.65	3.94	1.73	22
40181	40.0	30	13.19	8.50	13.78	9.45	.30	.47	8.27	3.07	1/4	5.12	5.79	6.65	3.94	1.73	22	

FOR REFERENCE ONLY UNLESS PROPERLY ENDORSED.

IN ORDER TO ACHIEVE ADEQUATE COOLING THE DRIVE MUST BE POSITIONED TO ALLOW A MINIMUM OF FREE AIR SPACE OF 1.2 INCHES ON SIDES AND 5 INCHES TOP AND BOTTOM



DR BY: RIP 9.29.04  
APPVL: TA 9.29.04

S - 5516

**DIMENSIONS: E7 (NEMA 1)**

**208/240V (88.0-115 AMPS) 480V (52.0-125 AMPS)**

**S - 5517**

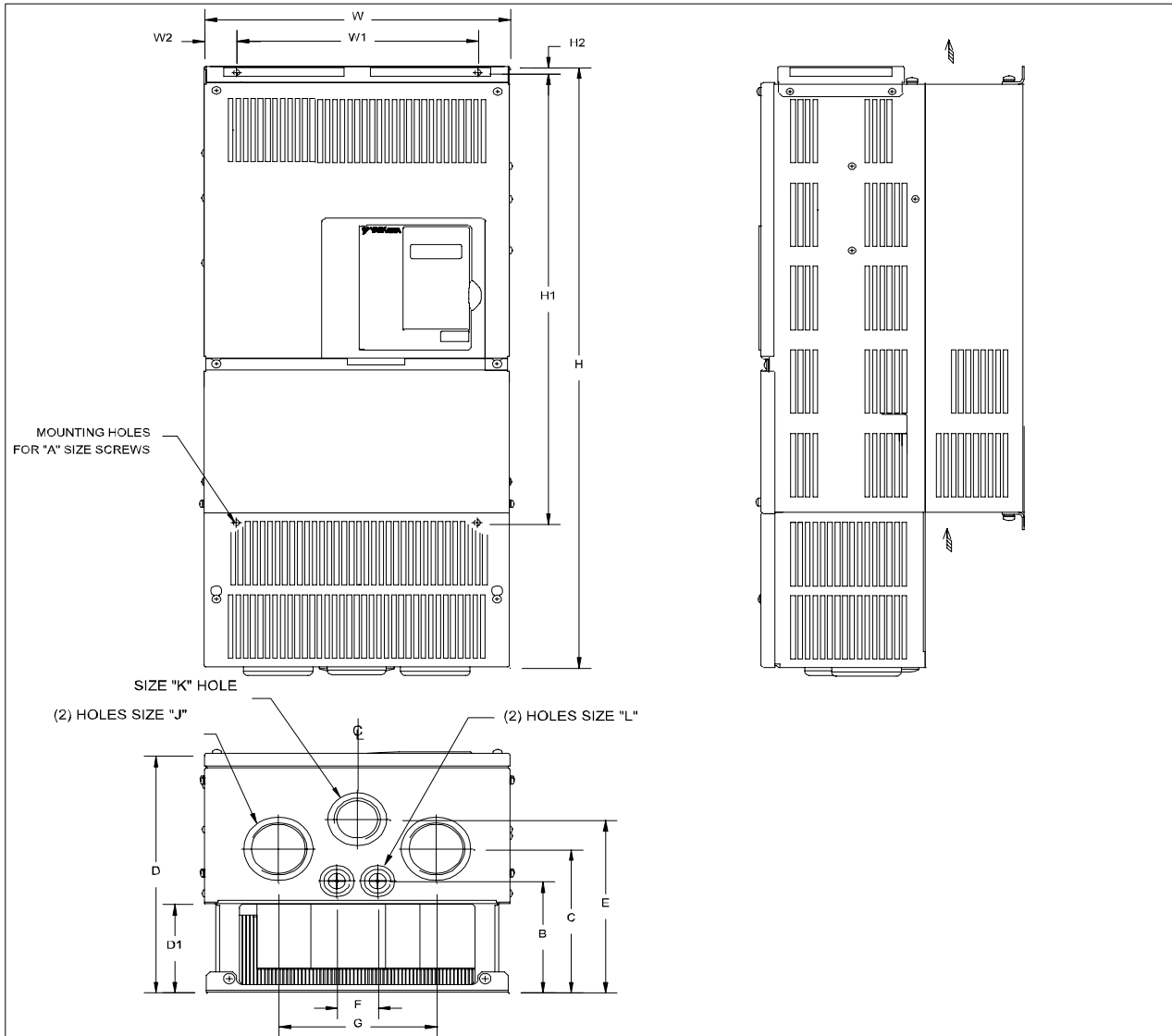

RATED INPUT	MODEL CIMR-E7U	RATED OUTPUT CURRENT (AMPS)	NOM. HP	DIMENSIONS IN INCHES																	APPROX. WEIGHT (LBS.)
				MOUNTING		H	W	H2	W2	D	D1	A	B	C	E	F	G	J	K	L	
				H1	W1																
208V	20221	88.0	30	15.16	7.66	21.06	10.00	.30	1.16	10.24	3.94	1/4	4.98	6.50	7.87	1.73	5.91	2.44	1.97	1.10	53
	20301	115	40	17.13	8.66	24.21	10.98	.30	1.16	10.24	3.94	1/4	4.98	6.50	7.87	1.73	5.91	2.44	1.97	1.10	59
240V	20221	88.0	30	15.16	7.68	21.06	10.00	.30	1.16	10.24	3.94	1/4	4.98	6.50	7.87	1.73	5.91	2.44	1.97	1.10	53
	20301	115	40	17.13	8.66	24.21	10.98	.30	1.16	10.24	3.94	1/4	4.98	6.50	7.87	1.73	5.91	2.44	1.97	1.10	59
480V	40241	52.0	40	17.13	8.66	21.06	10.98	.30	1.16	10.24	3.94	1/4	4.98	6.50	7.87	1.73	5.91	1.97	1.97	1.10	53
	40301	67.2	50	17.13	8.66	21.06	10.98	.30	1.16	10.24	3.94	1/4	4.98	6.50	7.87	1.73	5.91	1.97	1.97	1.10	53
	40371	77.0	60	21.06	10.24	25.00	12.95	.30	1.36	11.22	4.13	1/4	5.18	6.69	8.07	1.73	6.69	1.97	1.97	1.10	88
	40451	96.0	75	21.06	10.24	28.15	12.95	.30	1.36	11.22	4.13	1/4	5.18	6.69	8.07	1.73	6.69	2.44	1.97	1.10	88
	40551	125	100	21.06	10.24	28.15	12.95	.30	1.36	11.22	4.13	1/4	5.18	6.69	8.07	1.73	6.69	2.44	1.97	1.10	88

FOR REFERENCE ONLY UNLESS PROPERLY ENDORSED.  
 IN ORDER TO ACHIEVE ADEQUATE COOLING  
 THE DRIVE MUST BE POSITIONED TO ALLOW A MINIMUM  
 OF FREE AIR SPACE OF 1.2 INCHES ON SIDES AND  
 5 INCHES TOP AND BOTTOM



DR BY RIP 10-04  
 APPL. TA 10-04

**S - 5517**

**DIMENSIONS: E7 (PROTECTED CHASSIS)**

**208-230V (162-415 AMPS)  
480V (156-304 AMPS)**

**S - 5518**

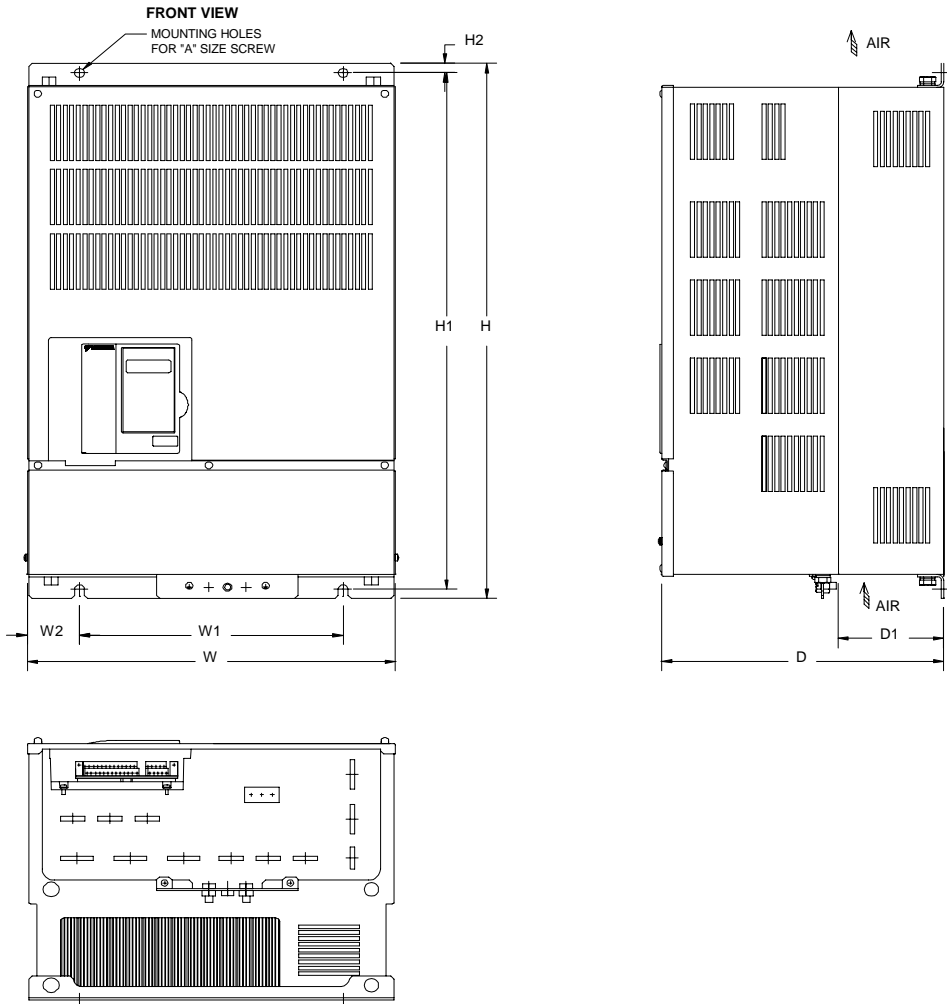

**S - 5518**

RATED INPUT	MODEL CIMR-E7U	RATED OUTPUT CURRENT (AMPS)	NOM. HP	DIMENSIONS IN INCHES								APPROX. WEIGHT (LBS.)	
				MOUNTING		H	W	H2	W2	D	D1		A
				H1	W1								
208V	20370	162	50	22.64	9.84	23.62	14.76	.49	2.46	11.81	3.94	3/8	125
	20450	192	60	22.64	9.84	23.62	14.76	.49	2.46	12.99	5.12	3/8	139
	20550	215	75	27.56	12.80	28.54	17.72	.49	2.46	13.78	5.12	3/8	180
	20750	312	100	27.56	12.80	28.54	17.72	.49	2.46	13.78	5.12	3/8	191
	20900	360	125	32.28	14.57	33.46	19.69	.59	2.56	14.17	5.12	3/8	238
	21100	415	150	33.66	17.52	34.84	22.64	.59	2.56	14.96	5.51	3/8	330
230V	20370	162	50-60	22.64	9.84	23.62	14.76	.49	2.46	11.81	3.94	3/8	125
	20450	192	75	22.64	9.84	23.62	14.76	.49	2.46	12.99	5.12	3/8	139
	20750	312	100-125	27.56	12.80	28.54	17.72	.49	2.46	13.78	5.12	3/8	191
480V	20900	360	150	32.28	14.57	33.46	19.69	.59	2.56	14.17	5.12	3/8	238
	40750	156	125	27.56	12.80	28.54	17.72	.49	2.46	13.78	5.12	3/8	194
	40900	180	150	27.56	12.80	28.54	17.72	.49	2.46	13.78	5.12	3/8	196
	41100	240	200	32.28	14.57	33.46	19.69	.59	2.56	14.17	5.12	3/8	224
	41600	304	250	33.66	17.52	36.06	22.64	.59	2.56	14.96	5.51	3/8	352

FOR REFERENCE ONLY UNLESS PROPERLY ENDORSED.

IN ORDER TO ACHIEVE ADEQUATE COOLING THE DRIVE MUST BE POSITIONED TO ALLOW A MINIMUM OF FREE AIR SPACE OF 1.2 INCHES ON SIDES AND 5 INCHES TOP AND BOTTOM



DR BY RIP 9.29.04  
APPVL. TA 9.29.04

**DIMENSIONS: E7 (PROTECTED CHASSIS)**

**S - 5519**

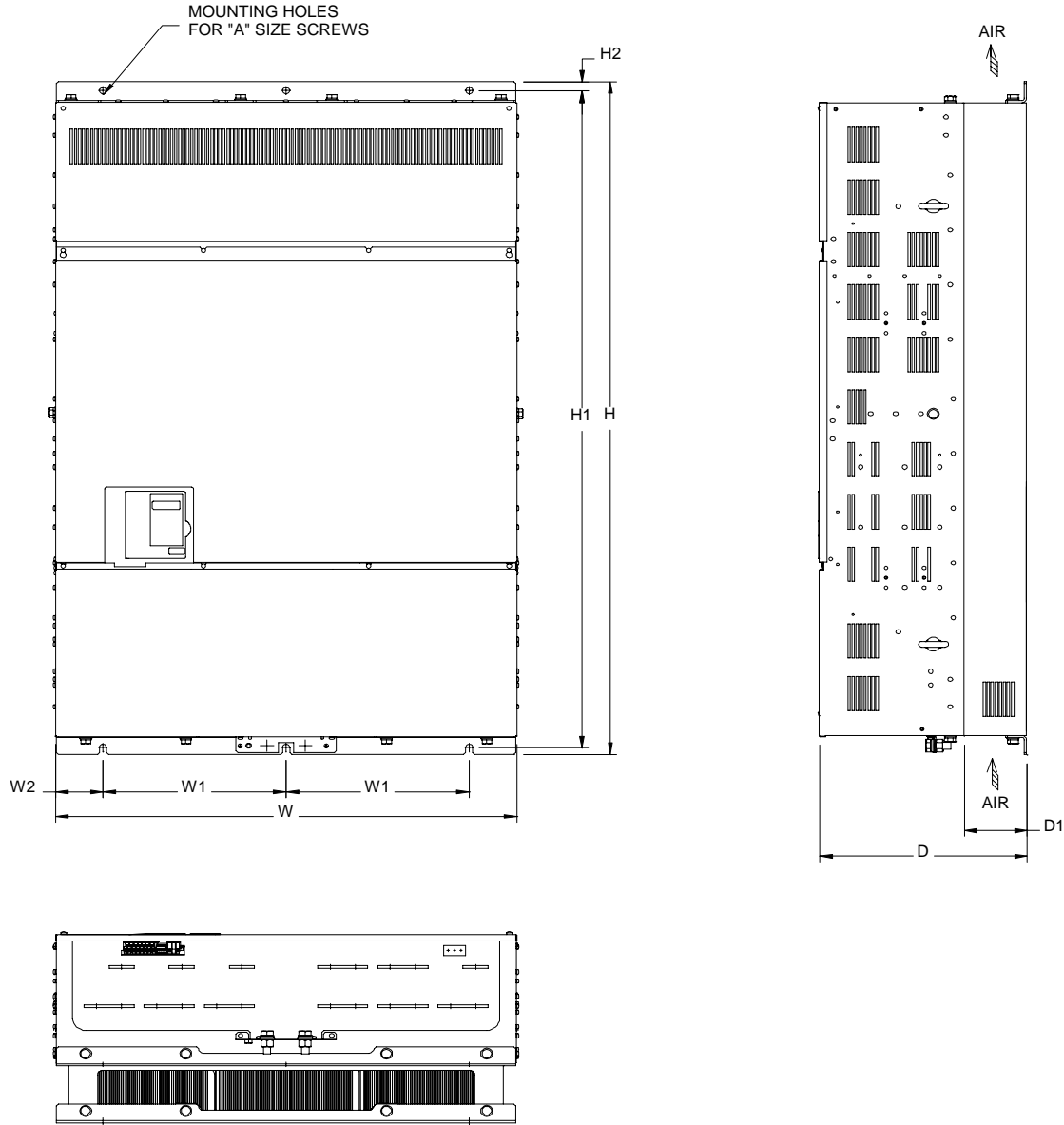

**S - 5519**

RATED INPUT	MODEL CIMR-E7U	RATED OUTPUT CURRENT (AMPS)	NOM. HP	DIMENSIONS IN INCHES								APPROX. WEIGHT (LBS.)	
				MOUNTING		H	W	H2	W2	D	D1		A
				H1	W1								
480V	41850	414	300-350	50.00	10.63	51.38	27.95	.79	3.35	16.34	4.94	3/8	572
	42200	515	400-450	50.00	10.63	51.38	27.95	.79	3.35	16.34	4.94	3/8	616
	43000	675	500	56.70	14.37	58.07	36.06	.79	3.66	16.34	4.94	3/8	891

FOR REFERENCE ONLY UNLESS PROPERLY ENDORSED.

IN ORDER TO ACHIEVE ADEQUATE COOLING THE DRIVE MUST BE POSITIONED TO ALLOW A MINIMUM OF FREE AIR OF 1.2 INCHES ON SIDES AND 5 INCHES TOP AND BOTTOM



DR BY RIP 8-02  
APPVL. TBS 9.5.02

# Heat Loss Data

Table 1.3 200V Class Heat Loss Data						
TYPE CIMR-E7U□	Drive (Inverter) Capacity (kVA)	Rated Output Current (A)	Cooling Fin Side (W)	Internal Unit Side (W)	Total Watt Loss (W)	Cooling Method
20P4	1.4	3.6	19	39	58	Self
20P7	1.8	4.6	26	42	68	Self
21P5	3.0	7.8	48	50	98	Self
22P2	4.1	10.8	68	59	127	Self
23P7	6.4	16.8	110	74	184	Fan
25P5	8.8	23	164	84	248	Fan
27P5	12	31	219	113	332	Fan
2011	18	46.2	357	168	524	Fan
2015	23	59.4	416	182	597	Fan
2018	29	74.8	472	208	680	Fan
2022	34	88	583	252	835	Fan
2030	44	115	883	333	1217	Fan
2037	62	162	1010	421	1430	Fan
2045	73	192	1228	499	1727	Fan
2055	82	215	1588	619	2206	Fan
2075	120	312	1956	844	2800	Fan
2090	140	360	2194	964	3157	Fan
2110	160	415	2733	1234	3967	Fan

TYPE CIMR-E7U□	Drive (Inverter) Capacity (kVA)	Rated Output Current (A)	Cooling Fin Side (W)	Internal Unit Side (W)	Total Watt Loss (W)	Cooling Method
40P4	1.4	1.8	14	39	53	Self
40P7	1.6	2.1	17	41	58	Self
41P5	2.8	3.7	36	48	84	Self
42P2	4.0	5.3	59	56	115	Fan
43P7	5.8	7.6	80	68	140	Fan
44P0	6.6	8.7	90	70	160	Fan
45P5	9.5	12.5	127	81	209	Fan
47P5	13	17	193	114	307	Fan
4009	21	21	232	158	390	Fan
4011	21	27	232	158	390	Fan
4015	26	34	296	169	465	Fan
4018	30	40	389	201	590	Fan
4022	38	50.4	420	233	653	Fan
4024	51	52	691	297	989	Fan
4030	51	67.2	691	297	989	Fan
4037	59	77	801	332	1133	Fan
4045	73	96	901	386	1287	Fan
4055	95	125	1204	478	1682	Fan
4075	120	156	1285	562	1847	Fan
4090	140	180	1614	673	2287	Fan
4110	180	240	1889	847	2736	Fan
4132	200	260	2388	1005	3393	Fan
4160	230	304	2636	1144	3936	Fan
4185	315	414	2791	1328	3964	Fan
4220	390	515	3797	1712	5509	Fan
4300	510	675	5838	2482	8319	Fan

# Checking and Controlling the Installation Site

Install the Drive as described below and maintain optimum conditions.

## WARNING

The Drive heatsink temperature may exceed 158°F (70°C). Therefore, mount the Drive to a surface suitable for high temperature.

---

## ◆ Installation Site

Locate the E7 Drive as close as possible to the motor. Install the Drive under the following conditions in UL Pollution Degree 1 & 2 environments. This excludes wet locations where surfaces may become conductive due to moisture and contaminant loading.

Type	Ambient Operating Temperature	Humidity	Plenum Rated
NEMA Type 1	14°F to 104°F (-10 to +40°C)	95% RH or less (no condensation)	Yes
Open Chassis	14°F to 113°F (-10 to +45°C)	95% RH or less (no condensation)	No

Protective covers are attached to the top and bottom of the Drive. It is recommended to remove the protective covers before operating a CIMR-E7U2030/4055 Drive and smaller in a panel to obtain the 113°F (45°C) ambient operating temperature.

Observe the following precautions when installing the Drive:

- in a clean location which is free from oil mist and dust.
- in an environment where metal shavings, oil, water, or other foreign materials will not get into the Drive enclosure.
- in a location free from radioactive materials.
- in a location free from harmful gasses and liquids.
- in a location free from excessive vibration.
- in a location free from chlorides.
- in a location away from direct sunlight.
- on a non-combustible surface.

---

## ◆ Controlling the Ambient Temperature

To enhance the reliability of operation, the Drive should be installed in an environment free from extreme temperature variations. If the Drive is installed in an enclosure, use a cooling fan or air conditioner to maintain the internal air temperature below 113°F (45°C).

---

## ◆ Protecting the Drive from Foreign Matter

During Drive installation and project construction it is possible to have foreign matter, such as metal shavings or wire clippings, fall inside the Drive. To prevent foreign matter from falling into the Drive, place a temporary cover over the Drive.

Always remove the temporary cover from the Drive before Start-Up. Otherwise, ventilation will be reduced, causing the Drive to overheat.

# Installation Orientation and Clearances

Install the Drive vertically so as not to reduce the cooling efficiency. When installing the Drive, always provide the following installation clearances to allow normal heat dissipation. For 3HP, 208V/240V (CIMR-E7U22P2 and below) or 2HP, 480V (CIMR-E7U41P5 and below), ensure that the heatsink is against a closed surface to avoid diverting cooling air around the heatsink.

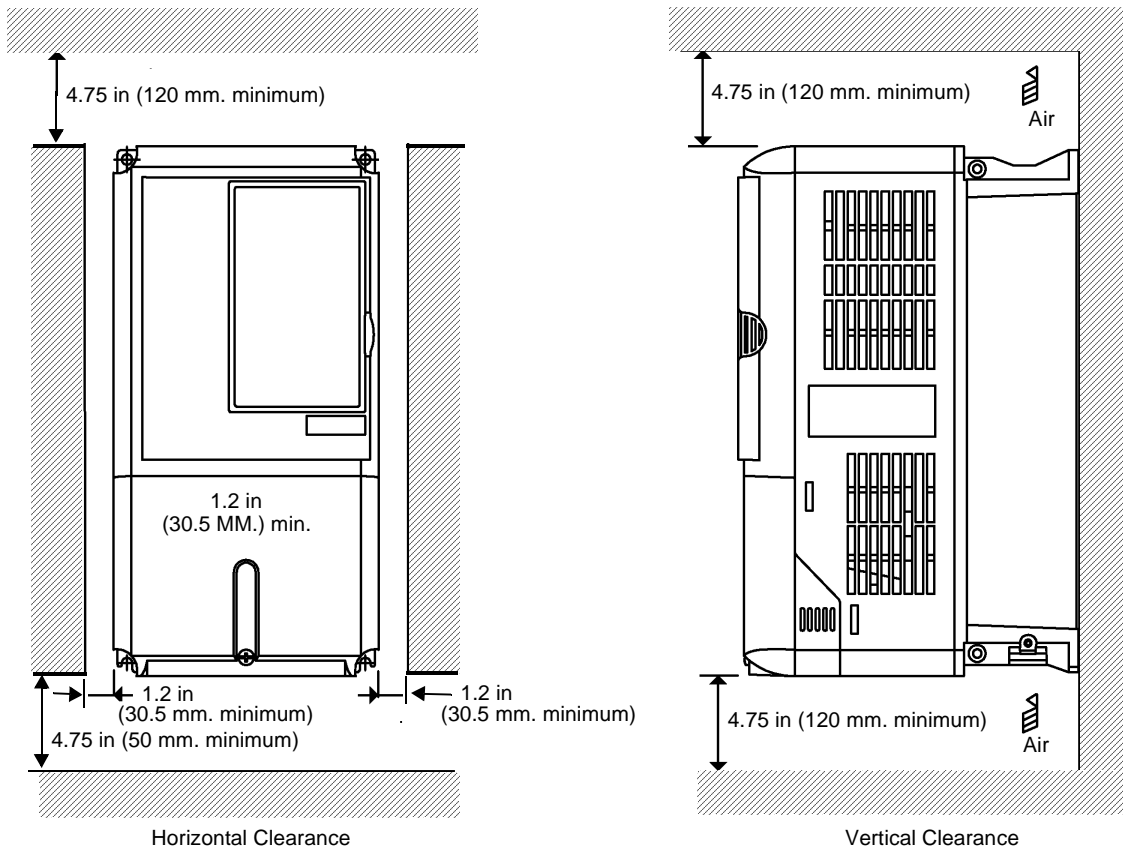

Fig 1.8 Drive Installation Orientation and Clearance

## IMPORTANT

1. The same clearance is required horizontally and vertically for both Open Chassis (IP00) and NEMA Type 1 Drives.
2. Always remove the top and bottom protection covers before installing a CIMR-E7U2018/4018 and smaller Drive in a panel.  
Always provide enough clearance for lifting eye bolts and the main circuit wiring when installing a CIMR-E7U2022/4030 and larger Drive in a panel.

# Removing and Attaching the Terminal Cover

Remove the terminal cover to connect cables to the control circuit and main circuit terminals.

## WARNING

Prior to removing any protective cover or wiring any part of the Drive, remove all power sources, including main input power and control circuit power. Wait a minimum of 5 minutes after power removal, before removing any cover. The charge lamp located within the Drive should be off prior to working inside. Even if the charge lamp is off, one must measure the AC input, output, and DC Bus potential to insure safe levels prior to resuming work. Failure to adhere to this warning may result in personal injury or death.

---

## ◆ Removing the Terminal Cover

### ■ Models CIMR-E7U20P4 thru 2018 (0.5HP to 25HP @ 208V/240V) and 40P4 thru 4018 (0.5HP to 30HP @ 480V)

Loosen the screw at the bottom of the terminal cover, press in on the sides of the terminal cover in the directions of arrows 1, and then lift up on the terminal in the direction of arrow 2. Refer to Figure 1.9

### ■ Models CIMR-E7U2022 thru 2110 (30HP to 150HP @ 208V/240V) and 4030 thru 4300 (40HP to 500HP @ 480V)

Loosen the screws on the left and right at the top of the terminal cover, pull down the terminal cover in the direction of arrow 1 and then lift up on the terminal cover in the direction of arrow 2. Refer to Figure 1.10

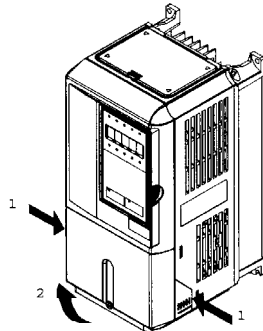

Fig 1.9 Removing the Terminal Cover

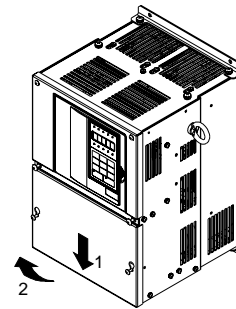

Fig 1.10 Removing the Terminal Cover

---

## ◆ Attaching the Terminal Cover

After wiring the terminal block, attach the terminal cover by reversing the removal procedure.

For Models CIMR-E7U2018/4018 and smaller, insert the tab on the top of the terminal cover into the groove on the Drive and press in on the bottom of the terminal cover until it snaps into place.

For Drives CIMR-E7U2022/4030 and larger, insert the tab on the top of the terminal cover into the groove on the Drive, and secure the terminal cover by lifting it up toward the top of the Drive.

# Removing/Attaching the Digital Operator and Front Cover

---

## ◆ Models CIMR-E7U20P4 thru 2018 (0.5HP to 25HP @ 208V/240V) and 40P4 thru 4018 (0.5HP to 30HP @ 480V)

For Models CIMR-E7U2018/4018 and smaller, remove the terminal cover and then use the following procedures to remove the Digital Operator and front cover.

### ■ Removing the Digital Operator

Press on the side of the Digital Operator in the direction of arrow 1 to unlock, then lift the Digital Operator in the direction of arrow 2 to remove it as shown in Fig 1.11.

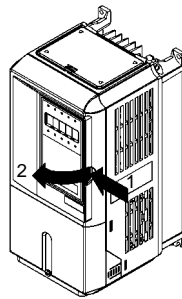

Fig 1.11 Removing the Digital Operator

### ■ Removing the Front Cover

Press the left and right sides of the front cover in the direction of arrows 1 and lift the bottom of cover in the direction of arrow 2 to remove it as shown in Fig 1.12.

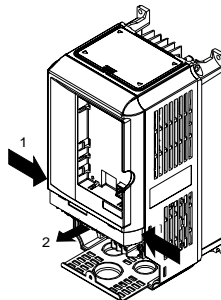

Fig 1.12 Removing the Front Cover

### ■ Attaching the Front Cover

Mount the front cover to the Drive by performing the steps to remove the front cover in reverse order.

1. Do not mount the front cover with the Digital Operator attached to the front cover; this may cause the Digital Operator to malfunction due to imperfect contact.
2. Insert the tab of the upper part of the front cover into the groove of the Drive and press the lower part of the front cover onto the Drive until the front cover snaps into place.

---

◆ **Models CIMR-E7U2022 thru 2110 (30HP to 150HP @ 208V/240V) and 4030 thru 4300 (40HP to 500HP @ 480V)**

For Models CIMR-E7U2022/4030 and larger, remove the terminal cover and then use the following procedures to remove the Digital Operator and front cover.

■ **Removing the Digital Operator**

Use the same procedure for Models CIMR-E7U2018/4018 and smaller.

■ **Removing the Front Cover**

Loosen all screws on the front cover. Lift up at the location labeled 1 at the top of the control circuit terminal card and move in the direction of arrow 2.

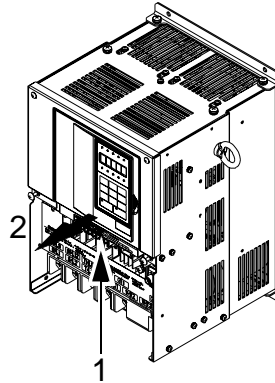

Fig 1.13 Removing the Front Cover

■ **Attaching the Front Cover**

Attach the front cover by reversing the procedure to remove it.

1. Confirm that the Digital Operator is not mounted on the front cover. Contact faults can occur if the cover is attached while the Digital Operator is mounted to it.
2. Insert the tab on the top of the front cover into the slot on the Drive and press in on the cover until it snaps into place on the Drive.

## ■ Attaching the Digital Operator

After attaching the front cover, mount the Digital Operator onto the Drive using the following procedure.

1. Hook the Digital Operator at A (two locations) on the front cover by moving in the direction of arrow 1 as shown in the following illustration.
2. Press the Digital Operator in the direction of arrow 2 until it snaps in place at B (two locations).

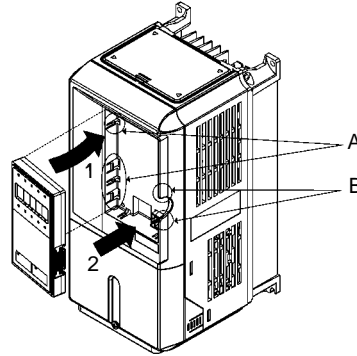

Fig 1.14 Mounting the Digital Operator

### IMPORTANT

1. Do not remove or attach the Digital Operator or mount or remove the front cover using methods other than those described above, damage to the Digital Operator or Drive may occur.
2. Never attach the front cover to the Drive with the Digital Operator attached to the front cover. Damage to the Digital Operator may occur. Always attach the front cover to the Drive first, and then attach the Digital Operator to the front cover.

# Chapter 2

## Electrical Installation

---

*This chapter describes wiring terminals, main circuit terminal connections, main circuit terminal wiring specifications, control circuit terminals, and control circuit wiring specifications.*

Terminal Block Configuration .....	2-2
Wiring Main Circuit Terminals.....	2-3
Control Wiring .....	2-12

# Terminal Block Configuration

The wiring terminals are shown in Fig 2.1.

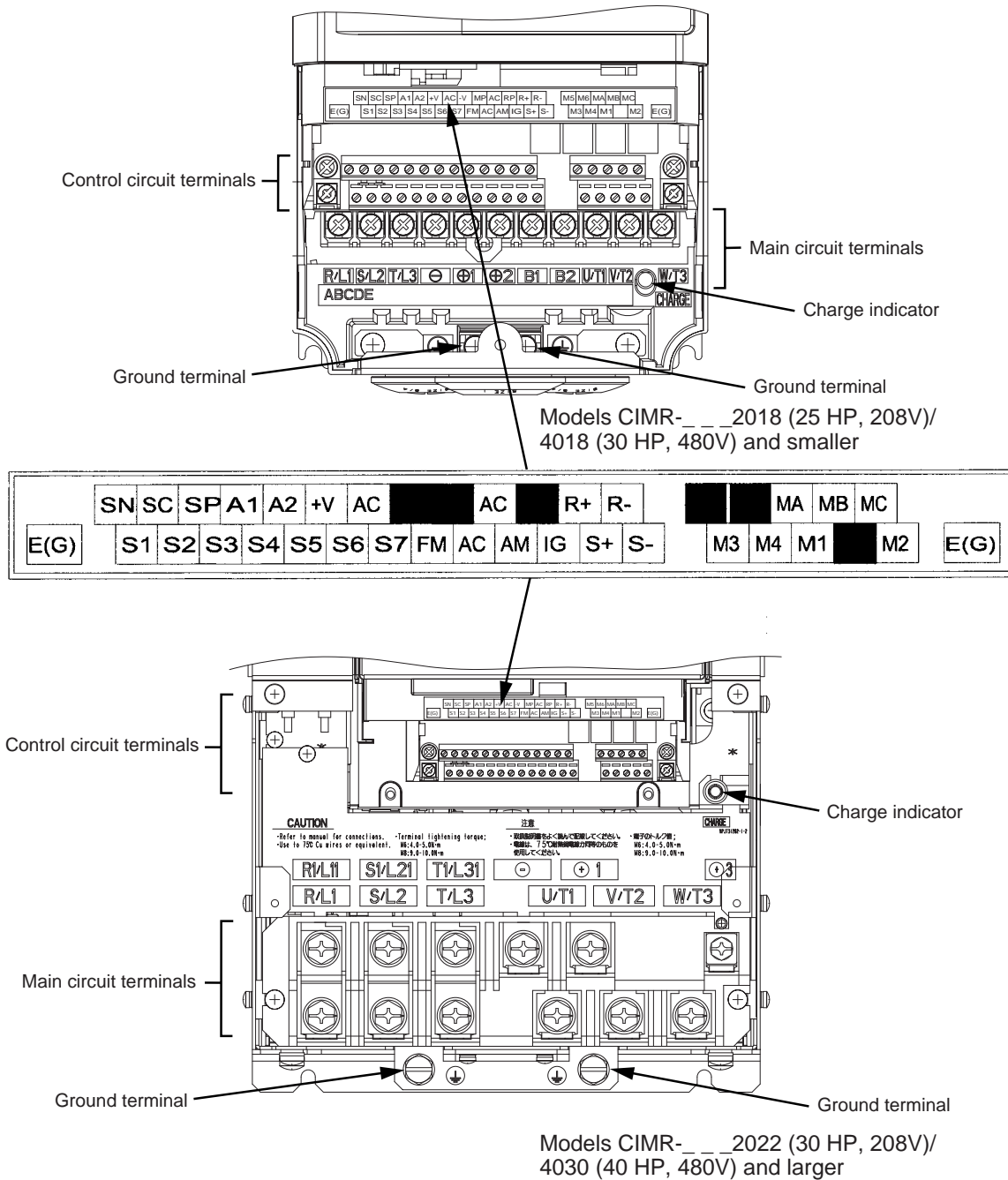

Fig 2.1 Drive Terminal Configuration

# Wiring Main Circuit Terminals

## ◆ Applicable Wire Sizes and Closed-loop Connectors

Select the appropriate wires and crimp terminals from Table 2.1 to Table 2.2.

Table 2.1 208-240Vac Wire Sizes and Connector Specifications						
Drive Model CIMR-E7U	Nominal Hp	Terminal Symbol	Terminal Screws	Clamping Torque lb. in. (N•m)	Recommended Wire Size AWG (mm <sup>2</sup> )	Wire Type
20P4	0.5/0.75	R/L1, S/L2, T/L3, ⊖, ⊕1, ⊕2, B1, B2, U/T1, V/T2, W/T3	M4	13.3 (1.5)	14 (2.1)	600Vac UL Approved vinyl-sheathed or equivalent
		⊕				
20P7	2	R/L1, S/L2, T/L3, ⊖, ⊕1, ⊕2, B1, B2, U/T1, V/T2, W/T3	M4	13.3 (1.5)	14 (2.1)	
		⊕				
21P5	1.5/2	R/L1, S/L2, T/L3, ⊖, ⊕1, ⊕2, B1, B2, U/T1, V/T2, W/T3	M4	13.3 (1.5)	14 (2.1)	
		⊕				
22P2	3	R/L1, S/L2, T/L3, ⊖, ⊕1, ⊕2, B1, B2, U/T1, V/T2, W/T3	M4	13.3 (1.5)	12 (3.3)	
		⊕				
23P7	5	R/L1, S/L2, T/L3, ⊖, ⊕1, ⊕2, B1, B2, U/T1, V/T2, W/T3	M4	13.3 (1.5)	10 (5.3)	
		⊕				
25P5	7.5	R/L1, S/L2, T/L3, ⊖, ⊕1, ⊕2, B1, B2, U/T1, V/T2, W/T3	M4	13.3 (1.5)	10 (5.3)	
		⊕				
27P5	10	R/L1, S/L2, T/L3, ⊖, ⊕1, ⊕2, B1, B2, U/T1, V/T2, W/T3	M5	22.1 (2.5)	8 (8)	
		⊕				
2011	15	R/L1, S/L2, T/L3, ⊖, ⊕1, ⊕2, B1, B2, U/T1, V/T2, W/T3	M5	22.1 (2.5)	6 (13.3)	
		⊕				
2015	20	R/L1, S/L2, T/L3, ⊖, ⊕1, ⊕2, U/T1, V/T2, W/T3	M6	44.3 (5.0)	4 (21.2)	
		B1, B2	M5	22.1 (2.5)	6 (13.3)	
		⊕	M6	44.3 (5.0)	6 (13.3)	
2018	25	R/L1, S/L2, T/L3, ⊖, ⊕1, ⊕2, U/T1, V/T2, W/T3	M8	88.5 (10.0)	2 (33.6)	
		B1, B2	M5	22.1 (2.5)	6 (13.3)	
		⊕	M6	44.3 (5.0)	4 (21.2)	
2022	30	R/L1, S/L2, T/L3, ⊖, ⊕1, U/T1, V/T2, W/T3, R1/L11, S1/L21, T1/L31	M8	88.5 (10.0)	1 (42.4)	
		⊕3	M6	45.1 (5.1)	4 (21.2)	
		⊕	M8	88.5 (10.0)	4 (21.2)	
2030	40	R/L1, S/L2, T/L3, ⊖, ⊕1 U/T1, V/T2, W/T3, R1/L11, S1/L21, T1/L31	M8	88.5 (10.0)	1/0 (53.5)	
		⊕3	M6	45.1 (5.1)	4 (21.2)	
		⊕	M8	88.5 (10.0)	2 (38)	

Table 2.1 208-240Vac Wire Sizes and Connector Specifications

Drive Model CIMR-E7U	Nominal Hp	Terminal Symbol	Terminal Screws	Clamping Torque lb. in. (N•m)	Recommended Wire Size AWG (mm <sup>2</sup> )	Wire Type
2037	50	R/L1, S/L2, T/L3, ⊖, ⊕ <sub>1</sub> U/T1, V/T2, W/T3, R1/L11, S1/L21, T1/L31	M10	199 (22.5)	4/0 (100)	600Vac UL Approved vinyl-sheathed or equivalent
		⊕ <sub>3</sub>	M8	88.5 (10.0)	4 (22)	
		⊖	M10	203.6 (23)	2/0 (67.4)	
		r/h, s/h	M4	12.4 (1.4)	14 (2.1)	
2045	60	R/L1, S/L2, T/L3, ⊖, ⊕ <sub>1</sub> U/T1, V/T2, W/T3, R1/L11, S1/L21, T1/L31	M10	199 (22.5)	300 (152)	
		⊕ <sub>3</sub>	M8	88.5 (10.0)	4 (21.2)	
		⊖	M10	199 (22.5)	3/0 (85)	
		r/h, s/h	M4	12.4 (1.4)	14 (2.1)	
2055	75	R/L1, S/L2, T/L3, ⊖, ⊕ <sub>1</sub>	M12	347 (39.2)	1/0 X 2P (53.5 X 2P)	
		U/T1, V/T2, W/T3, R1/L11, S1/L21, T1/L31	M10	199 (22.5)	1/0 X 2P (53.5 X 2P)	
		⊕ <sub>3</sub>	M8	88.5 (10.0)	2/0 (67.4)	
		⊖	M10	199 (22.5)	4/0 (107.2)	
		r/h, s/h	M4	12.4 (1.4)	14 (2.1)	
2075	75/100	R/L1, S/L2, T/L3, ⊖, ⊕ <sub>1</sub>	M12	347 (39.2)	4/0 X 2P (80 X 2P)	
		U/T1, V/T2, W/T3, R1/L11, S1/L21, T1/L31	M10	199 (22.5)	3/0 X 2P (85 X 2P)	
		⊕ <sub>3</sub>	M8	88.5 (10.0)	2/0 (67.4)	
		⊖	M10	199 (22.5)	2/0 X 2P (67.4 X 2P)	
		r/h, s/h	M4	12.4 (1.4)	14 (2.1)	
2090	125	R/L1, S/L2, T/L3, ⊖, ⊕ <sub>1</sub>	M12	347 (39.2)	250 x2P (127 x2P)	
		U/T1, V/T2, W/T3, R1/L11, S1/L21, T1/L31	M12	347 (39.2)	4/0 X 2P (107.2 X 2P)	
		⊕ <sub>3</sub>	M8	88.5 (10.0)	2/0 (67.4)	
		⊖	M12	347 (39.2)	2/0 X 2P (67.4 X 2P)	
		r/h, s/h	M4	12.4 (1.4)	14 (2.1)	
2110	150	R/L1, S/L2, T/L3, ⊖, ⊕ <sub>1</sub>	M12	347 (39.2)	300 X 2P (152 X 2P)	
		U/T1, V/T2, W/T3, R1/L11, S1/L21, T1/L31	M12	347 (39.2)	300 X 2P (152 X 2P)	
		⊕ <sub>3</sub>	M8	88.5 (10.0)	2/0 (67.4)	
		⊖	M12	347 (39.2)	4/0 X 2P (107.2 X 2P)	
		r/h, s/h	M4	12.4 (1.4)	16 (1.25)	

\* Use 75°C copper wire or equivalent

Table 2.2 480Vac Wire Sizes and Connector Specifications

Drive Model CIMR-E7U	Nominal Hp	Terminal Symbol	Terminal Screws	Clamping Torque lb. in. (N•m)	Recommended Wire Size AWG (mm <sup>2</sup> )	Wire Type
40P4	0.5/0.75	R/L1, S/L2, T/L3, ⊖, ⊕1, ⊕2, B1, B2, U/T1, V/T2, W/T3	M4	13.3 (1.5)	14 (2.1)	600Vac UL Approved vinyl-sheathed or equivalent
		⊕				
40P7	1	R/L1, S/L2, T/L3, ⊖, ⊕1, ⊕2, B1, B2, U/T1, V/T2, W/T3	M4	13.3 (1.5)	14 (2.1)	
		⊕				
41P5	1.5/2	R/L1, S/L2, T/L3, ⊖, ⊕1, ⊕2, B1, B2, U/T1, V/T2, W/T3	M4	13.3 (1.5)	14 (2.1)	
		⊕				
42P2	3	R/L1, S/L2, T/L3, ⊖, ⊕1, ⊕2, B1, B2, U/T1, V/T2, W/T3	M4	13.3 (1.5)	14 (2)	
		⊕				
43P7	5	R/L1, S/L2, T/L3, ⊖, ⊕1, ⊕2, B1, B2, U/T1, V/T2, W/T3	M4	13.3 (1.5)	14 (2.1)	
		⊕			14 (2.1)	
45P5	7.5	R/L1, S/L2, T/L3, ⊖, ⊕1, ⊕2, B1, B2, U/T1, V/T2, W/T3	M4	13.3 (1.5)	12 (3.5)	
		⊕			14 (2)	
47P5	10	R/L1, S/L2, T/L3, ⊖, ⊕1, ⊕2, B1, B2, U/T1, V/T2, W/T3	M4	13.3 (1.5)	10 (5.5)	
		⊕			12 (3.5)	
4011	15/20	R/L1, S/L2, T/L3, ⊖, ⊕1, ⊕2, B1, B2, U/T1, V/T2, W/T3	M5	22.1 (2.5)	8 (8)	
		⊕			10 (5.5)	
4015	25	R/L1, S/L2, T/L3, ⊖, ⊕1, ⊕2, B1, B2, U/T1, V/T2, W/T3	M5	22.1 (2.5)	8 (8)	
		⊕				
4018	30	R/L1, S/L2, T/L3, ⊖, ⊕1, ⊕3, U/T1, V/T2, W/T3, B1, B2	M6	44.3 (5.0)	6 (13.3)	
		⊕	M5	21.1 (2.5)	8 (8)	
		⊕	M6	44.3 (5.0)	6 (13.3)	
4030	40/50	R/L1, S/L2, T/L3, ⊖, ⊕1, ⊕3, U/T1, V/T2, W/T3, R1/L11, S1/L21, T1/L31	M6	44.3 (5.0)	3 (26.7)	
		⊕	M8	88.5 (10.0)	6 (13.3)	
4037	60	R/L1, S/L2, T/L3, ⊖, ⊕1, U/T1, V/T2, W/T3, R1/L11, S1/L21, T1/L31	M8	88.5 (10.0)	2 (33.6)	
		⊕3	M6	44.3 (5.0)	4 (21.2)	
		⊕	M8	88.5 (10.0)	4 (21.2)	
4045	75	R/L1, S/L2, T/L3, ⊖, ⊕1, U/T1, V/T2, W/T3, R1/L11, S1/L21, T1/L31	M8	88.5 (10.0)	2 (33.6)	
		⊕3	M6	44.3 (5.0)	4 (21.2)	
		⊕	M8	88.5 (10.0)	4 (21.2)	

Table 2.2 480Vac Wire Sizes and Connector Specifications

Drive Model CIMR-E7U	Nominal Hp	Terminal Symbol	Terminal Screws	Clamping Torque lb. in. (N•m)	Recommended Wire Size AWG (mm <sup>2</sup> )	Wire Type
4055	100	R/L1, S/L2, T/L3, ⊖, ⊕ <sub>1</sub> , U/T1, V/T2, W/T3, R1/L11, S1/L21, T1/L31	M8	88.5 (10.0)	2/0 (33.6)	600Vac UL Approved vinyl-sheathed or equivalent
		⊕ <sub>3</sub>	M6	44.3 (5.0)	4 (21.2)	
		⊖	M8	88.5 (10.0)	1 (42.4)	
4075	125	R/L1, S/L2, T/L3, ⊖, ⊕ <sub>1</sub>	M12	347 (39.2)	4/0 (107.2)	
		U/T1, V/T2, W/T3, R1/L11, S1/L21, T1/L31	M10	199 (22.5)	3/0 (85)	
		⊕ <sub>3</sub>	M8	88.5 (10.0)	4/0 (107.2)	
		⊖	M12	347 (39.2)	1/0 (53.5)	
		r/H, S200/I2200, S400/I2400	M4	12.4 (1.4)	14 (2.1)	
4090	150	R/L1, S/L2, T/L3, ⊖, ⊕ <sub>1</sub>	M12	347 (39.2)	250 (127)	
		U/T1, V/T2, W/T3, R1/L11, S1/L21, T1/L31	M10	199 (22.5)	4/0 (107.2)	
		⊕ <sub>3</sub>	M8	88.5 (10.0)	4/0 (107.2)	
		⊖	M12	347 (39.2)	2/0 (67.4)	
		r/H, S200/I2200, S400/I2400	M4	12.4 (1.4)	14 (2.1)	
4110	200	R/L1, S/L2, T/L3, ⊖, ⊕ <sub>1</sub>	M12	347 (39.2)	2/0 X 2P (67.4 X 2P)	
		U/T1, V/T2, W/T3, R1/L11, S1/L21, T1/L31	M12	347 (39.2)	1/0 X 2P (53.5 X 2P)	
		⊕ <sub>3</sub>	M8	88.5 (10.0)	2/0 (67.4)	
		⊖	M12	347 (39.2)	4/0 (107.2)	
		r/H, S200/I2200, S400/I2400	M4	12.4 (1.4)	14 (2.1)	
4160	250	R/L1, S/L2, T/L3, ⊖, ⊕ <sub>1</sub>	M12	347 (39.2)	4/0 X 2P (107.2 X 2P)	
		U/T1, V/T2, W/T3, R1/L11, S1/L21, T1/L31	M12	347 (39.2)	3/0 X 2P (85 X 2P)	
		⊕ <sub>3</sub>	M8	88.5 (10.0)	2/0 (67.4)	
		⊖	M12	347 (39.2)	1/0 X 2P (53.5 X 2P)	
		r/H, S200/I2200, S400/I2400	M4	12.4 (1.4)	14 (2.1)	

Table 2.2 480Vac Wire Sizes and Connector Specifications

Drive Model CIMR-E7U	Nominal Hp	Terminal Symbol	Terminal Screws	Clamping Torque lb. in. (N•m)	Recommended Wire Size AWG (mm <sup>2</sup> )	Wire Type
4185	300/350	R/L1, S/L2, T/L3, ⊖, ⊕1	M8	88.5 (10.0)	300 X 2P (152 X 2P)	600Vac UL Approved vinyl-sheathed or equivalent
		U/T1, V/T2, W/T3, R1/L11, S1/L21, T1/L33	M8	88.5 (10.0)	300 X 2P (152 X 2P)	
		⊕3	M8	88.5 (10.0)	2/0 (67.4)	
		⊖	M16	867.4 (98.0)	3/0 X 2P (85 X 2P)	
		r/H, Ⓐ200/Ⓐ200, Ⓐ400/Ⓐ400	M4	12.4 (1.4)	14 (2.1)	
4220	400/450	R/L1, S/L2, T/L3, ⊖, ⊕1	M8	88.5 (10.0)	500 X 2P (253 X 2P)	
		U/T1, V/T2, W/T3, R1/L11, S1/L21, T1/L33	M8	88.5 (10.0)	400 X 2P (203 X 2P)	
		⊕3	M8	88.5 (10.0)	2/0 (67.4)	
		⊖	M16	867.4 (98.0)	250 X 2P (127 X 2P)	
		r/H, Ⓐ200/Ⓐ200, Ⓐ400/Ⓐ400	M4	12.4 (1.4)	14 (2.1)	
4300	500+	R/L1, S/L2, T/L3, ⊖, ⊕1	M8	88.5 (10.0)	700 X 2P (355 X 2P)	
		U/T1, V/T2, W/T3, R1/L11, S1/L21, T1/L33	M8	88.5 (10.0)	600 X 2P (304 X 2P)	
		⊕3	M8	88.5 (10.0)	2/0 (67.4)	
		⊖	M8	867.4 (98.0)	400 X 2P (203 X 2P)	
		r/H, Ⓐ200/Ⓐ200, Ⓐ400/Ⓐ400	M16	12.4 (1.4)	14 (2.1)	

\* Use 75°C copper wire or equivalent.

**IMPORTANT**

Determine the wire size for the main circuit so that line voltage drop is within 2% of the rated voltage. Line voltage drop is calculated as follows:

$$\text{Line voltage drop (V)} = \sqrt{3} \times \text{wire resistance } (\Omega/\text{km}) \times \text{wire length (m)} \times \text{current (A)} \times 10^{-3}$$

**WARNING**

Prior to removing any protective cover or wiring any part of the Drive, remove all power sources, including main input power and control circuit power. Wait a minimum of 5 minutes after power removal, before removing any cover. The charge lamp located within the Drive should be off prior to working inside. Even if the charge lamp is off, one must measure the AC input, output, and DC Bus potential to insure safe levels prior to resuming work. Failure to adhere to this warning may result in personal injury or death.

## ◆ Main Circuit Terminal Functions

Main circuit terminal functions are summarized according to terminal symbols in Table 2.3. Wire the terminals correctly for the desired purpose.

Table 2.3 Main Circuit Terminal Functions (208-240Vac and 480Vac)			
Purpose	Terminal Designation	Model: CIMR-E7U_ _ _ _	
		208-240Vac	480Vac
Main circuit power input	R/L1, S/L2, T/L3	20P4 to 2110	40P4 to 4300
	R1/L11, S1/L21, T1/L31	2022 to 2110	4030 to 4300
Drive outputs	U/T1, V/T2, W/T3	20P4 to 2110	40P4 to 4300
DC power input	⊕1, ⊖	20P4 to 2110	40P4 to 4300
DC reactor connection	⊕1, ⊕2	20P4 to 2018	40P4 to 4018
Ground	⊖	20P4 to 2110	40P4 to 4300

## ◆ Main Circuit Configurations 208-240Vac

The 208-240Vac main circuit configurations of the Drive are shown in Table 2.4.

Table 2.4 Drive Main Circuit Configurations	
208-240 VAC	
<p>CIMR-___ 20P4 to 2018 (1/2 Hp to 25 Hp)</p> <p>Note 1</p>	<p>CIMR-___ 2022 and 2030 (30 Hp to 40 Hp)</p> <p>Notes 1 &amp; 3</p>
<p>CIMR-___ 2037 to 2110 (50 Hp to 150 Hp)</p> <p>Notes 1 &amp; 3</p>	<p>---</p>
<p>Note 1. Input fuses or molded case circuit breakers are required for proper branch circuit protection for all Drives. Failure to use recommended fuses/circuit breakers (See Appendix E) may result in damage to the wiring, Drive and/or personal injury.</p> <p>2. Control power is supplied internally from the main circuit DC power supply for all Drives.</p> <p>3. Consult your Yaskawa representative before using 12-pulse rectification.</p>	

## ◆ Main Circuit Configurations 480Vac

The 480Vac main circuit configurations of the Drive are shown in Table 2.5.

Table 2.5 Drive Main Circuit Configurations	
480 VAC	
<p style="text-align: center;">CIMR-___ 40P4 to 4018 (1/2 Hp to 30 Hp)</p> <p>Note 1</p>	<p style="text-align: center;">CIMR-___ 4030 to 4055 (40 Hp to 100 Hp)</p> <p>Notes 1 &amp; 3</p>
<p style="text-align: center;">CIMR-___ 4075 to 4160 and CIMR-___ 4185 to 4300 (125 Hp to 500 Hp)</p> <p>Notes 1 &amp; 3</p>	<p style="text-align: center;">---</p>
<p>Note 1. Input fuses or molded case circuit breakers are required for proper branch circuit protection for all Drives. Failure to use recommended fuses/circuit breakers (See Appendix E) may result in damage to the wiring, Drive and/or personal injury.</p> <p>2. Control power is supplied internally from the main circuit DC power supply for all Drives.</p> <p>3. Consult your Yaskawa representative before using 12-pulse rectification.</p>	

## Cable Length between Drive and Motor

The E7 should be installed as close as possible to the motor to minimize the length of load side power cable needed between the Drive and the motor.

If the cable between the Drive and the motor is long, the high-frequency leakage current will increase, causing the Drive output current to increase as well. This may affect peripheral devices. To prevent this, reduce the cable length whenever possible, or if necessary, adjust the carrier frequency (set in C6-02) as shown in Table 2.6.

The line side power cables, load side power cables and the control wiring should all be run in a separate conduit. Careful attention to this recommended design practice will avoid many potential motor and Drive related problems.

Motor Cable Length	164 ft. (50m) maximum	328 ft. (100m) maximum	More than 328 ft.(100m)
Carrier Frequency	15kHz maximum	10kHz maximum	5kHz maximum

(See the limitations on carrier frequency, based on Drive capacity and model number in Appendix B).

## ■ Ground Wiring

Observe the following precautions when connecting the ground wire:

1. 208-240Vac Drives should have a ground connection with resistance of less than 100Ω.
2. 480Vac Drives should have a ground connection with resistance of less than 10Ω.
3. Do not share the ground wire with other devices, such as motors or large-current electrical equipment.
4. Always use a ground wire that complies with technical standards on electrical equipment and minimize the length of the ground wire. Leakage current flows through the Drive. Therefore, if the distance between the ground rod and the ground terminal is too long, potential on the ground terminal of the Drive will become unstable.
5. When using more than one Drive, be careful not to loop the ground wire. See Fig 2.4.

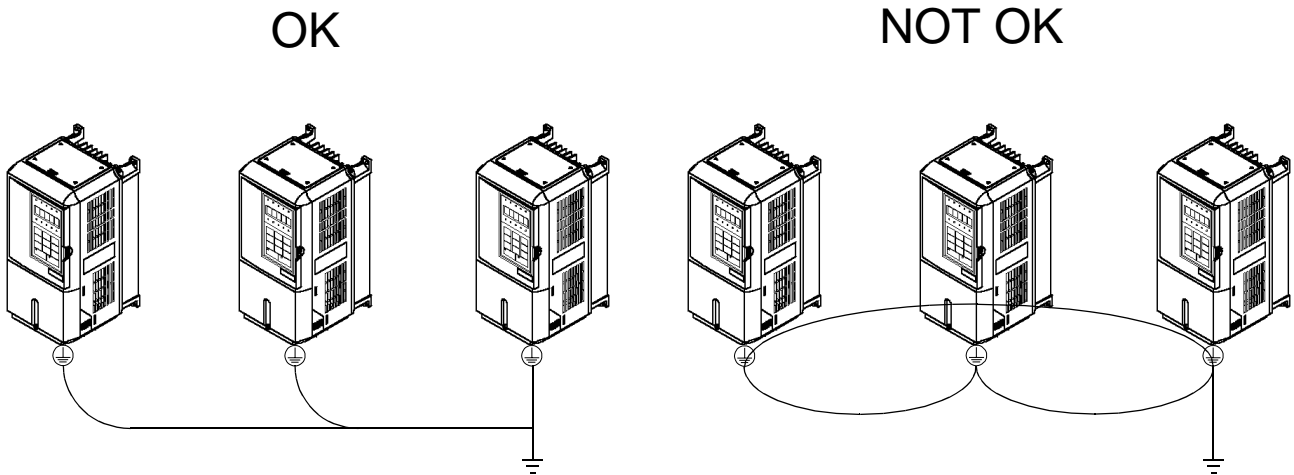

Fig 2.2 Ground Wiring Examples

## ■ Control Circuit Ground Terminals

The removable Drive control terminal card provides two ground terminals (marked TB3 and TB4) to accept the control wire shield connection. The control wire shield should be connected on this end only, the opposite end should be isolated with electrical tape.

**IMPORTANT**

Grounding of the E7 enclosure and motor is required for proper system operation.

# Control Wiring

## ◆ Control Circuit Wire Sizes

The auto mode speed reference (speed command) field wiring connection is made to E7 Drive terminals A1 or A2 (signal positive), AC (signal common) and G (shield). Keep this lead length as short as possible to maintain signal quality. Insulated twisted shielded pair wire (2 conductor # 18 ga, Belden 8760 or equivalent) is required. Do not run these wires in the same conduit as other AC power or control wires. The shield must be connected on this end only, stub and isolate the other end. The A2 signal employed is 4 to 20 mA with parameter H3-08 set for “2: 4 - 20 mA”. For 0 to 10 VDC, parameter H3-08 is set for “0: 0 - 10 VDC” and the E7 control board DIP switch S1-2 must be in the OFF position. (See Fig 2.4).

For remote operation, keep the length of the control wiring to 50m or less. Separate the control wiring from high-power lines (input power, motor leads or relay sequence circuits) to reduce noise induction from peripheral devices.

When setting speed commands (frequency references) from an external speed potentiometer (and not from the Digital Operator), use shielded twisted-pair wires and ground the shield to terminal E(G), as shown in Fig 2.3. Terminal numbers and wire sizes are shown in Table 2.7.

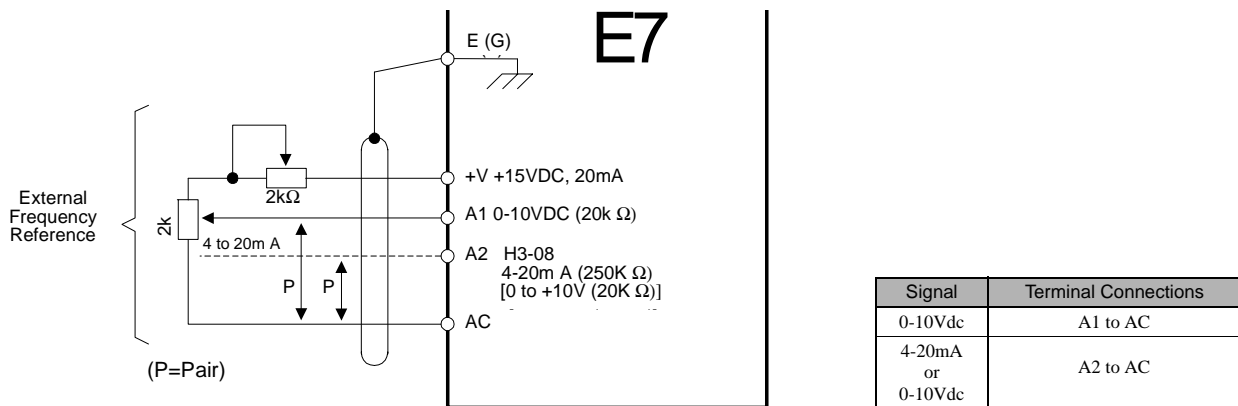

Fig 2.3 Analog Input Terminal Configuration

Table 2.7 Terminal Numbers and Wire Sizes (Same for all Drives)					
Terminals	Terminal Screws	Tightening Torque lb-in (N•m)	Possible Wire Sizes AWG (mm <sup>2</sup> )	Recommended Wire Size AWG (mm <sup>2</sup> )	Wire Type
S1, S2, S3, S4, S5, S6, S7 SN, SC, SP, +V, A1, A2, AC, MI, M2, M3, M4, MA, MB, MC, FM, AC, AM, R+, R-, S+, S-, IG	Phoenix type *3	4.2 to 5.3 (0.5 to 0.6)	Stranded wire: 26 to 16 (0.14 to 1.5)	18 (0.75)	<ul style="list-style-type: none"> <li>Shielded, twisted-pair wire*1</li> <li>Shielded, polyethylene-covered, vinyl sheath cable</li> </ul>
E(G)	M3.5	7.0 to 8.8 (0.8 to 1.0)	20 to 14 (0.5 to 2*2)	12 (1.25)	

\*1. Use shielded twisted-pair cables to input an external speed command.  
 \*2. Yaskawa recommends using straight solderless terminals on digital inputs to simplify wiring and improve reliability.  
 \*3. Yaskawa recommends using a thin-slot screwdriver with a 3.5 mm blade width.

---

## ◆ Wiring Checks

After all wiring is completed, perform the following checks:

1. Is all wiring correct?
2. Have all wire clippings, screws or other foreign material been removed from the Drive enclosure?
3. Are all terminal screws tight?

## ◆ Control Circuit Terminal Functions

The factory default functions of the control circuit terminals for 2-wire control are shown in Table 2.8.

Type	No.	Signal Name	Description	Signal Level		
Digital input signals	S1	Forward run/stop command	Forward run when CLOSED; stopped when OPEN.	24 Vdc, 8 mA Photocoupler isolation		
	S2	Reverse run/stop command	Reverse run when CLOSED; stopped when OPEN.			
	S3	External fault input	Fault when CLOSED.		Multi-function digital inputs Functions set by H1-01 to H1-05.	
	S4	Fault reset	Reset when CLOSED			
	S5	Multi-step speed reference 1 (Master/auxiliary switch)	Auxiliary frequency reference when CLOSED.			
	S6	Multi-step speed reference 2	Multi-step setting 2 when CLOSED.			
	S7	Jog frequency reference	Jog frequency when CLOSED.			
	SN	Digital input common	Refer to Table 2.10 for connection details.			
	SC					
SP						
Analog input signals	+V	+15Vdc power supply	+15Vdc power supply for analog inputs or transmitters	+15Vdc (Max. current: 20 mA)		
	A1	Analog input or Speed Command	0 to +10Vdc/100%			
	A2	Multi-function analog input	4 to 20 mA/100% 0 to +10Vdc/100% (H3-0)	Function set by H3-09.	4 to 20 mA(250Ω) 0 to +10 V(20kΩ)	
	AC	Analog common	-			
	E(G)	Shield wire, optional ground line connection point	-			
Digital output signals	M1	During Run (N.O. contact)	CLOSED during operation	Multi-function digital output Function set by H2-01.	Dry contacts Contact capacity: 1 A max. at 250Vac 1 A max. at 30Vdc	
	M2					
	M3	Remote/Auto Operation (N.O. contact)	CLOSED when local control	Multi-function digital output Function set by H2-02.		
	M4					
	MA	Fault output signal (SPDT)	MA/MC: CLOSED during fault condition MB/MC: OPEN during fault condition			
	MB					
MC						
Analog output signals	FM	Multi-function analog output	(output frequency) 0 to +10Vdc/100% frequency	Multi-function analog monitor 1 Function set by H4-01	0 to +10Vdc max. ±5% 2 mA max.	
	AC	Analog common	-			
	AM	Multi-function analog output	(output current) 0 to +10Vdc/100% Drive's rated output current	Multi-function analog monitor 2 Function set by H4-04		
RS-485/422	R+	Modbus communication input	For 2-wire RS-485, jumper R+ and S+ and jumper R- and S-.		Differential input, PHC isolation	
	R-					
	S+	Modbus communication output			Differential input, PHC isolation	
	S-					
	IG	Signal common	-		-	

## ◆ DIP Switch S1

DIP Switch S1 is described in this section. The functions of DIP switch S1 are shown in Table 2.9.

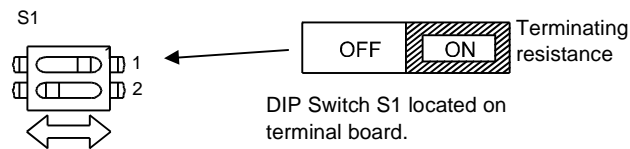
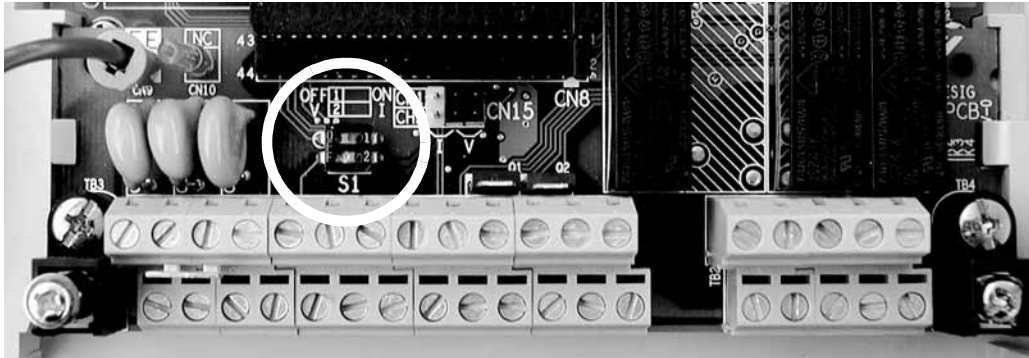

Fig 2.4 DIP Switch S1 Location

Table 2.9 DIP Switch S1		
Name	Function	Setting
S1-1	RS-485 and RS-422 terminating resistance	OFF: No terminating resistance ON: Terminating resistance of 110Ω Factory Default = OFF
S1-2	Input method for analog input A2	OFF: 0-10 Vdc (internal resistance: 20KΩ) ON: 4-20mA (internal resistance: 250Ω) Factory Default = ON

## ◆ Shunt Connector CN15

The shunt connector CN15 is described in this section. Shunt connector along with parameters H4-07 and H4-08 select the signal range of the analog output terminals FM and AM.

Shunt connector CN15 is only available when the optional Terminal Card with the 4-20mA Analog Output Monitor is installed (Model No. ETC618120). See Chapter 7, Maintenance, for installation of the optional Terminal Card.

The function of various shunt connector CN15 configurations is shown in Table 2.10.

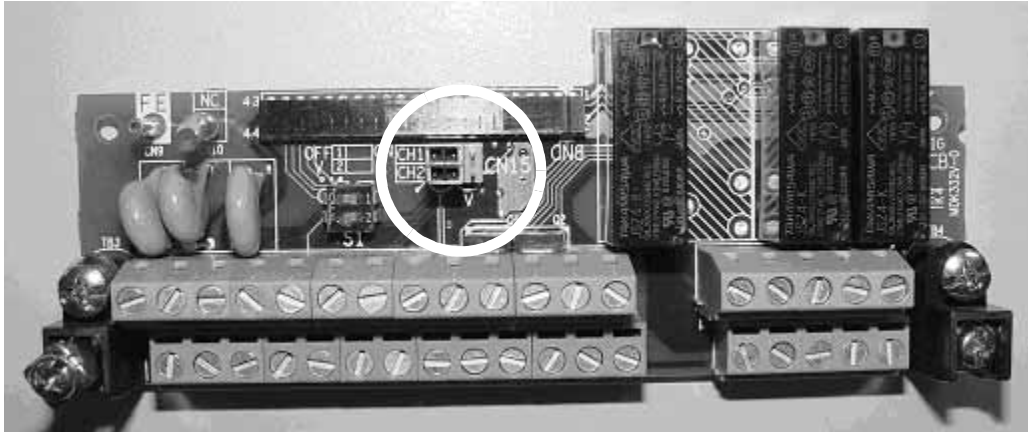

Fig 2.5 Shunt Connector CN15 Location

CN15	Analog Output Monitor Configurations
	Voltage Output (0-10Vdc) for terminals FM-AC (CH1) and AM-AC (CH2)
	Current Output (4-20mA) for terminals FM-AC (CH1) and AM-AC (CH2)
	Voltage Output (0-10Vdc) for terminals FM-AC (CH1) Current Output (4-20mA) for terminals AM-AC (CH2)
	Current Output (4-20mA) for terminals FM-AC (CH1) Voltage Output (0-10Vdc) for terminals AM-AC (CH2)

The software configuration for the analog output monitor signal type is listed below:

Parameter No.	Parameter Name Digital Operator Display	Description	Setting Range	Factory Setting	Menu Location
H4-07	Terminal FM Signal Level Selection <b>AO Level Select1</b>	0: 0 - 10 V 2: 4-20 mA	0 or 2	0	Programming
H4-08	Terminal AM Signal Level Selection <b>AO Level Select2</b>	0: 0 - 10 V 2: 4-20 mA	0 or 2	0	Programming

## ◆ Sinking/Sourcing Mode

The input terminal logic can be switched between sinking mode (0V common) and sourcing mode (+24V common) by using the terminals SN, SC, and SP. An external power supply can also be connected, providing more freedom in signal input methods.

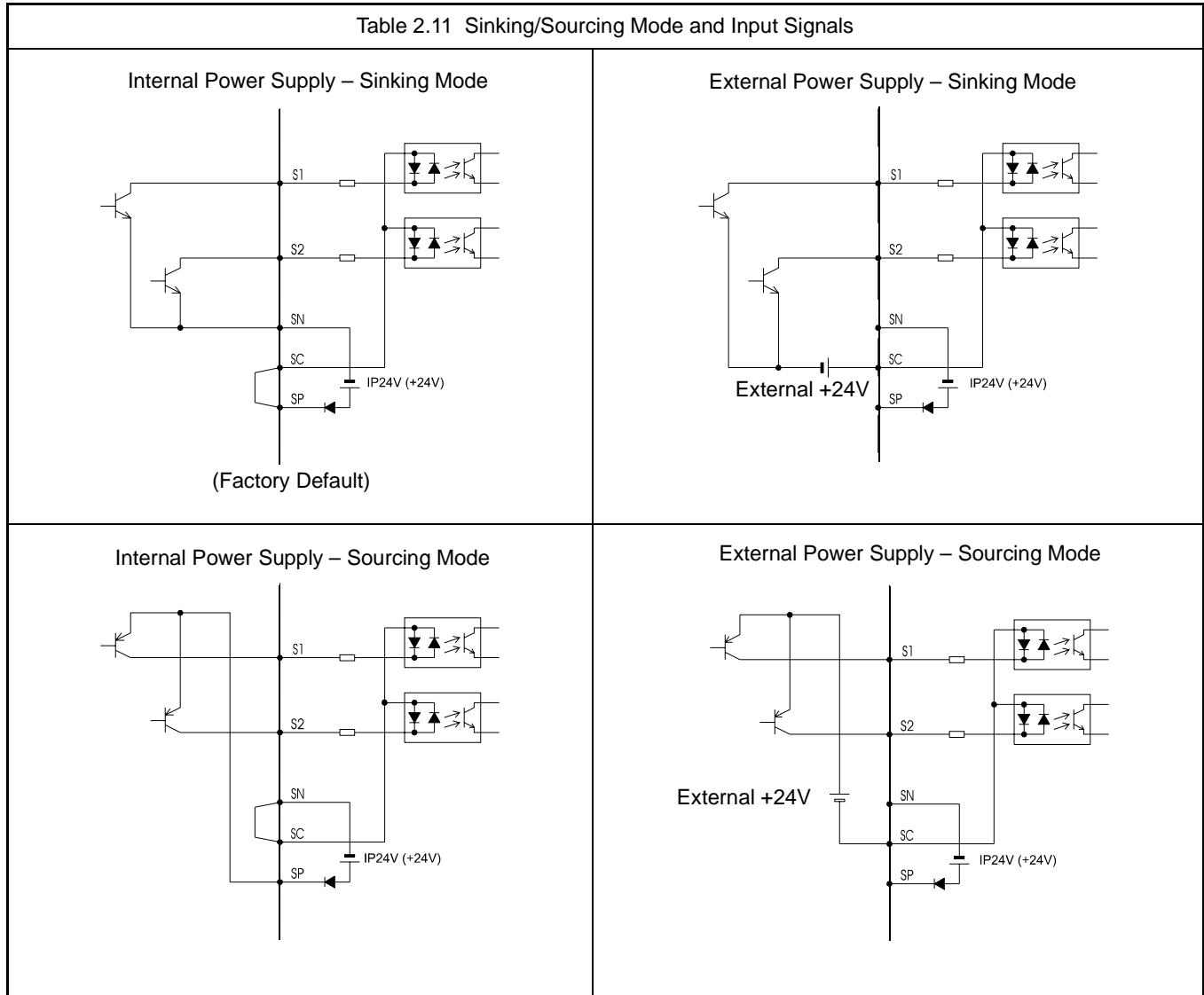

# ◆ Terminal Connections

Connections to Drive terminals are shown in Fig 2.8.

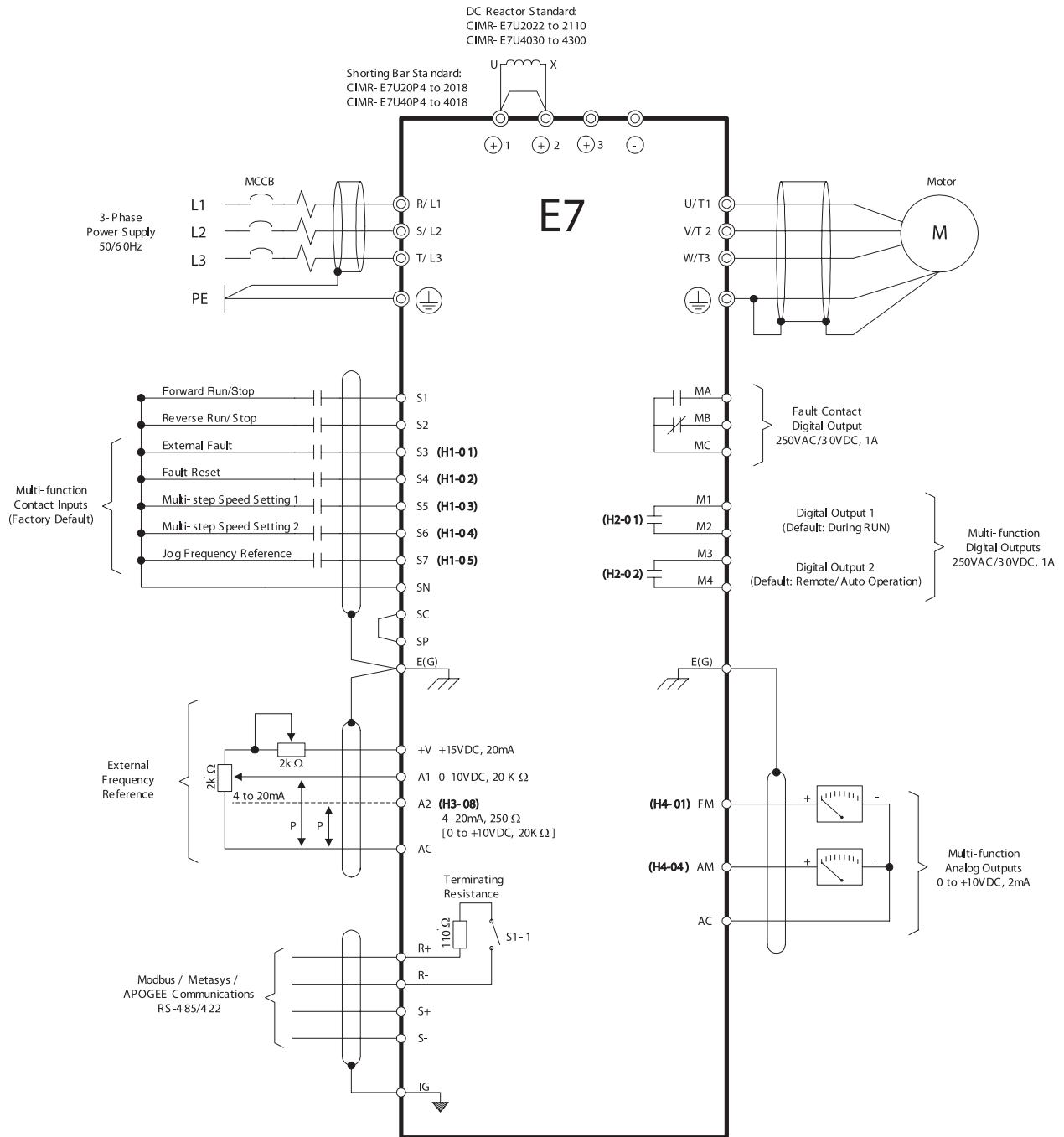

Fig 2.6 Terminal Connections

---

## ◆ Control Circuit Wiring Precautions

Observe the following precautions when wiring control circuits:

1. Separate control wiring from power/motor wiring (terminals R/L1, S/L2, T/L3, U/T1, V/T2, W/T3,  $\ominus$ ,  $\oplus 1$ ,  $\oplus 2$ , and  $\oplus 3$ ) and other high-power lines.
2. Separate wiring for control circuit terminals MA, MB, MC, M1, M2, M3, and M4 (digital outputs) from wiring to other control circuit terminals.
3. If using an optional external power supply, ensure it is a UL Listed Class 2 power supply source.
4. Use twisted-pair or shielded twisted-pair cables for control circuits to prevent operating faults. Prepare cable ends as shown in *Fig 2.9*.
5. Connect the shield wire to terminal E(G).
6. Insulate the shield with tape to prevent contact with other signal lines and equipment.

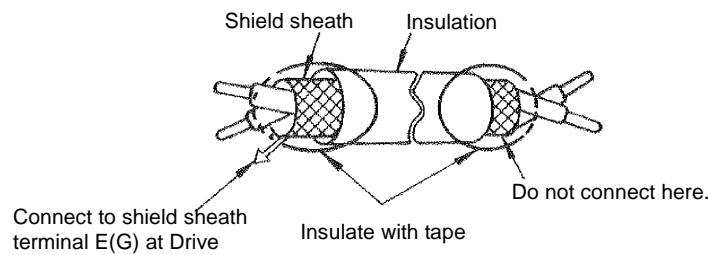

Fig 2.7 Preparing the Termination of Shielded Twisted-pair Cables

## ◆ Field Wiring Diagram

Use this diagram to document field wiring. It may be helpful to copy this page.

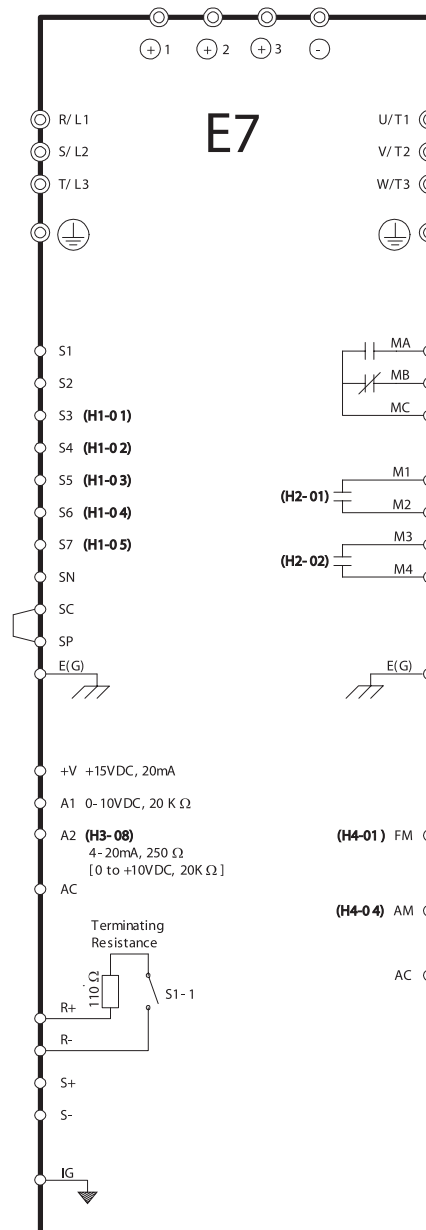

Fig 2.8 Field Wiring Diagram

# Chapter 3

## Digital Operator

---

*This chapter describes the displays and functions of the Digital Operator.*

Digital Operator Display.....	3-2
Digital Operator Keys .....	3-3
Drive Mode Indicators.....	3-5
Drive Main Menu .....	3-7
Quick Setting Menu (-QUICK-) .....	3-12
Programming Menu (-ADV-) .....	3-13
Example of Changing a Parameter .....	3-15

# Digital Operator Display

The Digital Operator is used for programming, operating, and monitoring drive operation. By default the E7 Drive will not run unless the digital operator is securely attached to the Drive.

The various items included on the Digital Operator are described below.

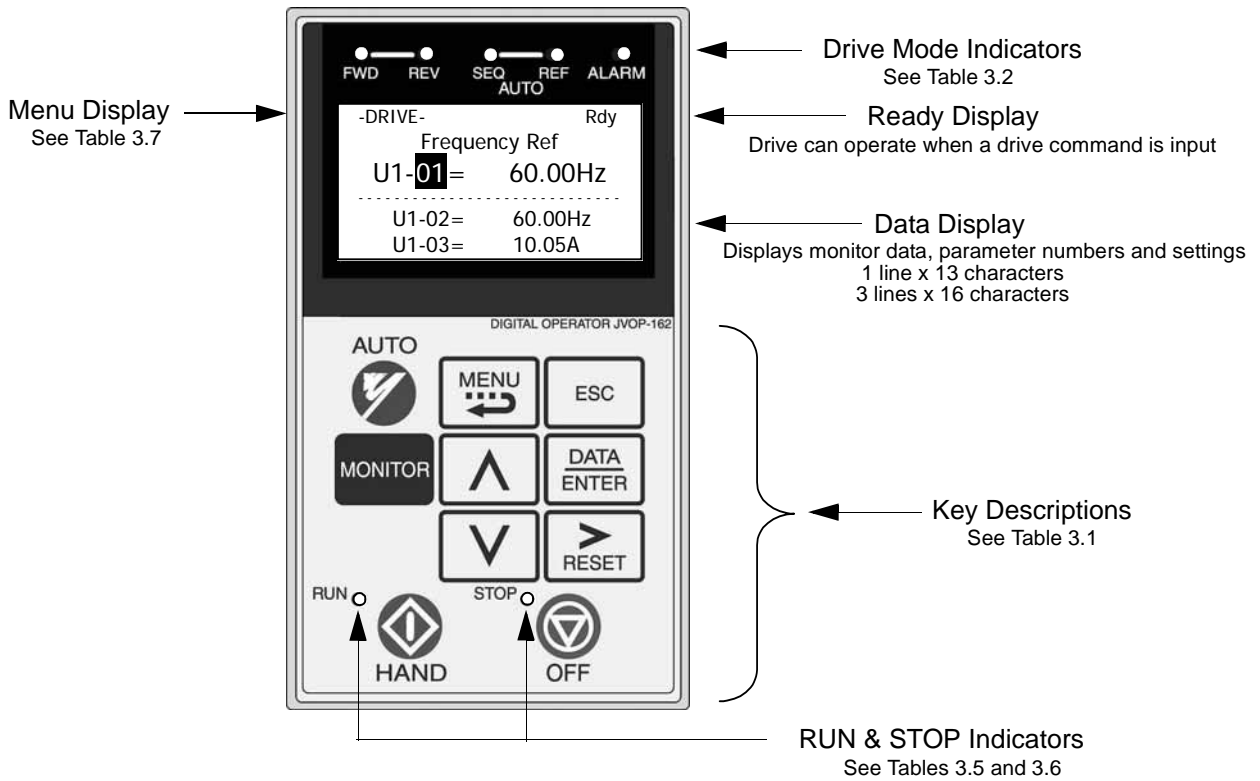

Fig 3.1 Digital Operator Component Names and Functions

## WARNING

The digital operator can be used to operate (start) the Drive. Incorrect programming and/or improper key selection on the digital operator may result in the Drive starting unexpectedly. Prior to making any adjustments with the digital operator, insure that all personnel are clear from the Drive, motor, and machine. Also, insure that all covers, couplings, pulleys, shaft keys, etc. are secure.

# Digital Operator Keys

The names and functions of the Digital Operator Keys are described in Table 3.1.



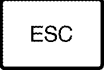







Table 3.1 Digital Operator Keys		
Key	Name	Function
	AUTO Key	<ul style="list-style-type: none"> <li>Pressing the AUTO key will put the Drive in the “Auto” mode.</li> <li>In the “Auto” mode, the Drive will be capable of starting/stopping depending on the setting of parameter “b1-02” (Run Command Selection).</li> <li>In the “Auto” mode, the Drive speed command (frequency reference) will depend on the setting of parameter “b1-01” (Frequency Reference Selection).</li> <li>If the OFF key is pressed, the “Auto” mode frequency reference will continue to be displayed on the keypad.</li> <li>Pressing the AUTO key will start the Drive if the run command is already closed.</li> <li>If the Drive is running in the “Auto” mode and the OFF key is pressed, the Drive will stop. If the run command remains closed, pressing the AUTO key will restart the Drive.</li> <li>While the Drive is running, the run command can be opened to stop and closed to restart without taking the Drive out of the “Auto” mode.</li> <li>The Drive must be in a stopped condition before it can be transferred to “Auto” or “Hand” mode, unless b1-13=1.</li> </ul>
	MENU Key	Scrolls through the five main menus.
	ESCAPE Key	Returns to the previous display, before the DATA/ENTER key was pressed.
	MONITOR Key	Selects the monitor mode from the Operation (-DRIVE-), Quick Setting (-QUICK-), Programming (-ADV-) and Modified Constants (-VERIFY-) menus.
	INCREASE Key	Increases parameter numbers and set values. Used to move to the next item or data value.
	DECREASE Key	Decreases parameter numbers and set values. Used to move to the previous item or data value.
	SHIFT/RESET Key	Selects the digit to be changed. The selected digit will blink. Also resets the Drive when a fault has occurred.
	DATA/ENTER Key	Pressed to enter menus and parameters as well as to set values.

Table 3.1 Digital Operator Keys

Key	Name	Function
	HAND Key	<ul style="list-style-type: none"> <li>• Pressing the HAND key will put the Drive in the “Hand” mode and start the Drive.</li> <li>• In the “Hand” mode, the drive speed command will depend on the setting of parameter “b1-12” (Hand Frequency Reference Selection).</li> <li>• If the OFF key is pressed, the “Hand” mode speed command will continue to be displayed on the keypad.</li> <li>• The Drive must to be in a stopped condition before it can be transferred to “Hand” or “Auto” mode, unless b5-13=1.</li> </ul>
	OFF Key	Stops Drive operation, following the stopping method as programmed in parameter b1-03.

# Drive Mode Indicators

The definition of the Drive mode indicators are shown in Table 3.2.

Table 3.2 Drive Mode Indicators	
Indicator	Definition
FWD	Lit when a forward run command is input and when Drive is in “Hand” Mode.
REV	Lit when a reverse run command is input.
AUTO SEQ	Lit when set up for remote run command. See Table 3.3
AUTO REF	Lit when set up for remote speed command. See Table 3.4
ALARM	Lit when a fault has occurred. Flashes when an alarm has occurred.

## ◆ AUTO Sequence (SEQ) Indicator

The status of the AUTO “Sequence” (SEQ) indicator is shown in Table 3.3. This indicator is always “Off” when the Drive is in the “Hand” mode. When the Drive is in the “Auto” mode, the SEQ indicator status is dependent on the setting of parameter “b1-02” (Run Command Selection).

Table 3.3 AUTO Sequence (SEQ) Indicator		
Indicator Status	Hand Mode	Auto Mode
On	N/A	Parameter “b1-02” (Run Command Selection) is set to terminal strip, communications, or an option board as indicated below: b1-02=1 (Terminals) =2 (Communications) =3 (Option PCB)
Off		Parameter “b1-02” (Run Command Selection) is set to digital operator as indicated below: b1-02=0 (Operator)

---

## ◆ AUTO Reference (REF) Indicator

The status of the AUTO “Reference” (REF) indicator is shown in Table 3.4. This indicator is always “Off” when the Drive is in the “Hand” mode. When the Drive is in the “Auto” mode, the REF indicator status is dependent on the setting of parameter “b1-01” (Frequency Reference Selection).

Indicator Status	Hand Mode	Auto Mode
On	N/A	Parameter “b1-01” (Frequency Reference Selection) is set to terminal strip, communications, or an option board as indicated below: b1-01=1 (Terminals) =2 (Communications) =3 (Option PCB)
Off		Parameter “b1-01” (Frequency Reference Selection) is set to digital operator as indicated below: b1-01=0 (Operator)

---

## ◆ Run Indicator

The status of the “RUN” indicator is shown in Table 3.5 when the Drive is in either the “Hand” or “Auto” mode.

Indicator Status	Condition
On	Drive is running
Blinking	Drive is decelerating to a stop
Off	Drive is stopped

---

## ◆ Stop Indicator

The status of the “STOP” indicator is shown in Table 3.6 when the Drive is in either the “Hand” or “Auto” mode.

Indicator Status	Condition
On	Drive is decelerating to a stop or stopped
Blinking	Drive is in a run condition but the frequency reference is zero or Drive is running in “Auto” mode and OFF has been pressed
Off	Drive is running

# Drive Main Menu

The Drive's parameters and monitoring functions are organized into menu groups that make it easier to read and set parameters. The Drive is equipped with five menu selections. The five selections and their primary functions are shown in Table 3.7 and are directly available by pressing the MENU key.

Main Menu	Primary Function(s)
Operation - DRIVE -	The Drive can be run in this menu. Use this menu for monitoring values such as frequency reference or output current, displaying fault history or displaying the fault traces.
Quick Setting - QUICK -	The Drive can be programmed in this menu. Use this menu to set/read the most commonly used parameters.
Programming - ADV -	The Drive can be programmed in this menu. Use this menu to set/read every parameter.
Modified Constants - VERIFY -	The Drive can be programmed in this menu. Use this menu to set/read the parameters that have been modified from their factory default settings.
Auto-Tuning - A.TUNE -	The Drive can be programmed in this menu. Use this menu to auto-tune the Drive in order to optimize motor control as well as utilize the bi-directional speed search feature.

## ◆ Main Menu Structure

The menu selection display will appear when the MENU key is pressed from a monitor or setting display. While viewing the menu selection display, press the MENU key repeatedly to scroll between the menu selections.

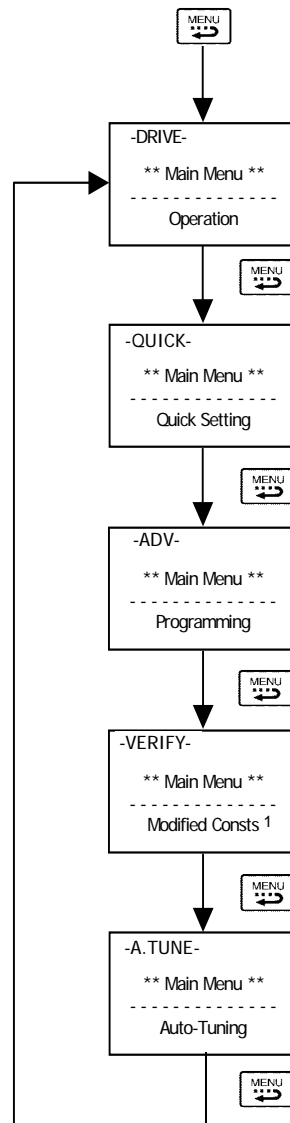

Fig 3.2 Main Menu Structure

Press the DATA/ENTER key to enter the desired menu selection.

<sup>1</sup> Modified Consts = Modified Parameters

## ◆ Operation Menu (-DRIVE-)

This menu is used for setting a speed command or monitoring values such as output frequency and output current. It is also used for displaying the fault history and the fault traces. The Drive must be in this menu in order to run, see parameter b1-08.

### IMPORTANT

Leaving the Drive in a menu other than the Operation Menu, will prohibit the Drive from running. While running, if the Drive is in a menu other than "Operation" and the run command is removed and re-applied, the Drive will stop and will not start until the Operation Menu is selected .

### U1 Monitor List

Follow the key operations below (Fig.3.3) to access the Operation Menu:

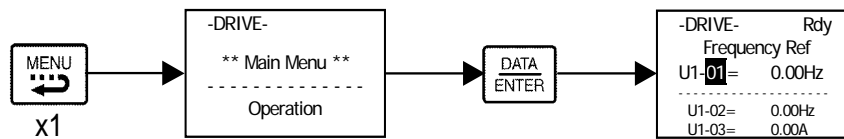

Fig 3.3 U1 Monitor List Access Procedure

Use  and  keys to scroll through the U1 "Monitor" parameter list. See Appendix A for functional description.

Monitor		Monitor	
U1-01	Frequency Ref	U1-20	SFS Output (Soft Starter Signal)
U1-02	Output Freq	U1-24	PI Feedback
U1-03	Output Current	U1-28	CPU ID
U1-06	Output Voltage	U1-29	kWh
U1-07	DC Bus Voltage	U1-30	MWh
U1-08	Output kWatts	U1-34	OPE Detected
U1-10	Input Term Sts	U1-36	PI Input
U1-11	Output Term Sts	U1-37	PI Output
U1-12	Int Ctl Sts 1	U1-38	PI Setpoint
U1-13	Elapsed Time	U1-39	Transmit Err
U1-14	FLASH ID	U1-40	FAN Elapsed Time
U1-15	Term A1 Level	U1-51	Auto Mode Fref
U1-16	Term A2 Level	U1-52	Hand Mode Fref
U1-18	Mot SEC Current (Secondary Current)	U1-53	PI Feedback 2

## ■ U2 Fault Trace List

After viewing the “Monitor” parameter list, in order to view the “Fault Trace” parameter list, follow the key operations below (Fig.3.4).

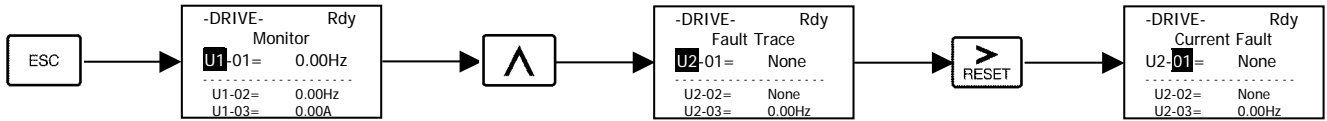

Fig 3.4 U2 Fault Trace List Access Procedure



Use  and  keys to scroll through the U2 “Fault Trace” parameter list.

Table 3.9 U2 Fault Trace List	
Fault Trace Parameters	
U2-01	Current Fault
U2-02	Last Fault
U2-03	Frequency Ref
U2-04	Output Freq
U2-05	Output Current
U2-07	Output Voltage
U2-08	DC Bus Voltage
U2-09	Output kWatts
U2-11	Input Term Sts
U2-12	Output Term Sts
U2-13	AC Drive Status
U2-14	Elapsed Time

### ■ U3 Fault History List

After viewing the “Fault Trace” parameter list, in order to view the “Fault History” parameter list, follow the key operations below Fig. 3.5).

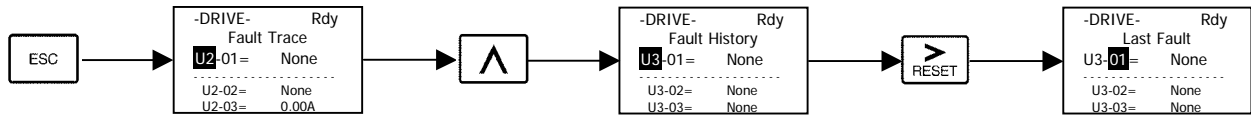

Fig 3.5 U3 Fault History Access Procedure

Use and keys to scroll through the U3 “Fault History” parameter list.

Table 3.10 Fault History List	
Fault History Parameters	
U3-01	Last Fault
U3-02	Fault Message 2
U3-03	Fault Message 3
U3-04	Fault Message 4
U3-05	Elapsed Time 1
U3-06	Elapsed Time 2
U3-07	Elapsed Time 3
U3-08	Elapsed Time 4
U3-09	Fault Message 5
U3-10	Fault Message 6
U3-11	Fault Message 7
U3-12	Fault Message 8
U3-13	Fault Message 9
U3-14	Fault Message 10
U3-15	Elapsed Time 5
U3-16	Elapsed Time 6
U3-17	Elapsed Time 7
U3-18	Elapsed Time 8
U3-19	Elapsed Time 9
U3-20	Elapsed Time 10

# Quick Setting Menu (-QUICK-)

This menu is used to set/read the most commonly used parameters in the Drive. Follow the key operations below (Fig. 3.6) to access the Quick Setting Menu:

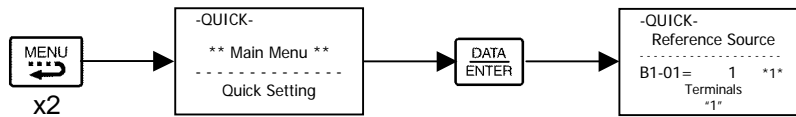

Fig 3.6 Quick Setting Parameter Access Procedure



Use  and  keys to scroll through the “Quick Setting” parameter list.

Table 3.11 Quick Setting Parameter List	
Parameter Number	Parameter Name
b1-01	Frequency Reference Selection
b1-02	Run command Selection
b1-03	Stopping Method Selection
b5-01	PI Mode Selection
b5-02*	Proportional Gain Setting
b5-03*	Integral Time Setting
b5-31*	PI Unit Selection
C1-01	Acceleration Time 1
C1-02	Deceleration Time 1
d2-01	Frequency Reference Upper Limit
d2-02	Frequency Reference Lower Limit
E1-01	Input Voltage Setting
E2-01	Motor Rated Current
H3-08*	Terminal A2 Signal Level Selection
H3-09*	Auxiliary Terminal Function Selection
H3-13*	Master/Frequency Reference Terminal Selection

\* This parameter’s menu location is Quick Setting when b5-01=1, and Programming when b5-01=0.

# Programming Menu (-ADV-)

This menu is used to set/read every parameter in the Drive. Follow the key operations below (Fig. 3.7) to access the Programming Menu.

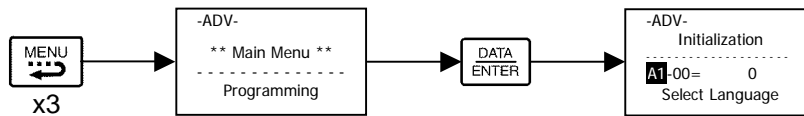

Fig 3.7 Programming Menu Access Procedure

Use , , and  keys to scroll through the “Programming” parameter group list. For complete parameter listing see appendix A.

Table 3.12 Programming Parameter Group List	
Parameter Group Functions	
A1	Initialization
A2	User Parameters
b1	Sequence
b2	DC Braking
b3	Speed Search
b4	Delay Timers
b5	PI Control
b8	Energy Saving
C1	Accel/Decel
C2	S-Curve Acc/Dec
C4	Torque Comp
C6	Carrier Freq
d1	Preset Reference
d2	Reference Limits
d3	Jump Frequencies
d4	Sequence
E1	V/F Pattern
E2	Motor Setup
F6	Com OPT Setup
H1	Digital Inputs
H2	Digital Outputs
H3	Analog Inputs
H4	Analog Outputs
H5	Serial Com Setup
L1	Motor Overload
L2	PwrLoss Ridethru
L3	Stall Prevention
L4	Ref Detection
L5	Fault Restart
L6	Torque Detection
L8	Hdwe Protection
n1	Hunting Prev
n3	High Slip
o1	Monitor Select
o2	Key Selections
o3	COPY Function

## ◆ Modified Constants Menu (-VERIFY-)

This menu is used to set/read the parameters that have been modified from their original factory default settings. Follow the key operations below (Fig. 3.8) to access the Modified Constants Parameter Menu.

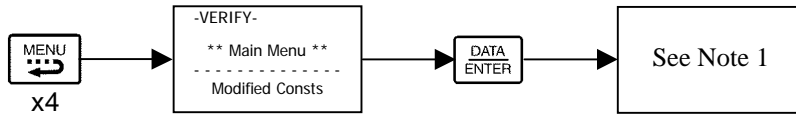

Fig 3.8 Modified Constants Menu Access Procedure

Note 1: If there are not any parameters that have been modified from their original factory default settings, then the display will state “None Modified”. Otherwise, use the “increase” and “decrease” keys to scroll through the “Modified Constants” list.

## ◆ Auto-Tuning Menu (-A.TUNE-)

This menu is used to auto-tune the Drive in order to optimize motor control as well as utilize the bi-directional speed search feature. Follow the key operations below (Fig. 3.9) to access the Auto-Tuning Menu.

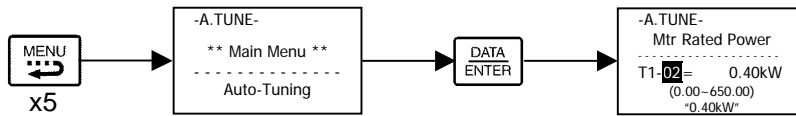

Fig 3.9 Auto-Tuning Menu Access Procedure



Use  and  keys to scroll through the “Auto-Tuning” parameter list.

Table 3.13 Auto-Tuning Parameter List	
Auto-Tuning Parameters	
T1-02	Mtr Rated Power
T1-04	Rated Current

# Example of Changing a Parameter

Table 3.14 provides an example of how to change parameter “C1-02” (Deceleration Time 1) from 30 seconds to 40 seconds.

Table 3.14 Changing a Parameter in the Programming Menu		
Step Number	Digital Operator Display	Description
1		The Drive is first powered up.
2		Press the MENU key to scroll to “Operation” menu.
3		Press the MENU key to scroll to “Quick Setting” menu.
4		Press the MENU key to scroll to “Programming” menu.
5		Press the DATA/ENTER key to enter “Programming” menu.
6		Press the INCREASE key until C1-01 (Accel/Decel) is displayed.
7		Press the SHIFT/RESET key to move flashing digit to the right.

Table 3.14 Changing a Parameter in the Programming Menu

Step Number	Digital Operator Display	Description
8		Press the INCREASE key to display C1-02 (Decel Time 1).
9		Press the DATA/ENTER key to access setting display.
10		Press the SHIFT/RESET key to move the flashing digit to the right.
11		Press the SHIFT/RESET key to move the flashing digit to the right.
12		Press the INCREASE key to increase the set data.
13		Press the DATA/ENTER key to enter the set data. "Entry Accepted" is displayed for 1.0 sec after the data setting has been confirmed.
14		The monitor display for C1-02 returns.
15		Press the MENU key to scroll to "Operation" menu.
16		Press the DATA/ENTER key to enter "Operation" menu.

# Chapter 4

## Start Up

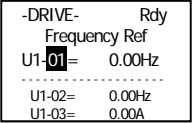
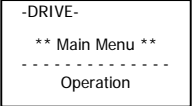
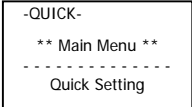
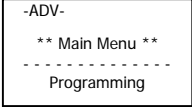
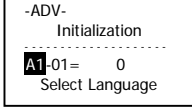
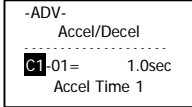
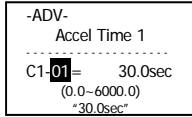
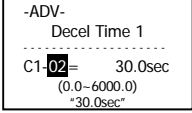
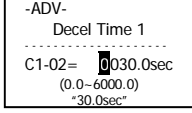
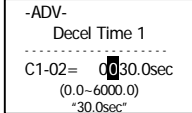
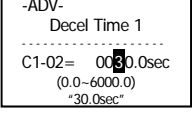
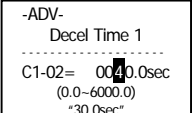
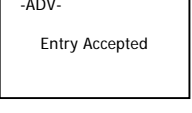
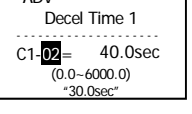
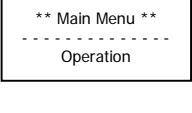
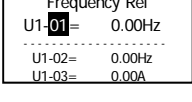
---

*This chapter describes the procedures to prepare the Drive for start up and the procedures to conduct a Drive start up.*

Drive Start Up Preparation .....	4-2
Drive Start Up Procedures .....	4-5

# Start Up

In order to provide the most reliable Drive available and to avoid any extra costs related to loss or reduction of warranty coverage, an authorized Yaskawa service representative should complete this start up procedure. Please complete the following checklist and maintain it in a secure location as technical service personnel may request information from this checklist.

---

## ◆ DRIVE START UP PREPARATION

Date: \_\_\_\_\_

### **Start Up Person:**

Company Name: \_\_\_\_\_

Start Up Location: \_\_\_\_\_

Sales Order #: \_\_\_\_\_

Serial #: \_\_\_\_\_

Printed Name: \_\_\_\_\_

Drive Location: \_\_\_\_\_

Phone #: \_\_\_\_\_

Signature: \_\_\_\_\_

### **Owners Representative:**

Printed Name: \_\_\_\_\_

Phone #: \_\_\_\_\_

Company: \_\_\_\_\_

Signature: \_\_\_\_\_

### **Step**

- 1. The Drive is thoroughly tested at the factory. The start up person should verify that the drive is free of shipping and installation damage. Shipping damage is not covered by the Yaskawa warranty. Claims must be filed with the shipping company as soon as possible for any potential recovery via insurance.
- 2. Review the E7 User Manual (TM.E7.01) shipped with the Drive.
- 3. Verify that the model number and voltage ratings in the purchase order match the nameplate data for each unit.
- 4. Location of the Drive is important to achieve proper performance and normal operating life. The unit should be installed in an area where it is protected from:
  - Direct sunlight, rain or moisture
  - Corrosive gases or liquids
  - Vibration, airborne dust or metallic particles
- 5. Ensure the Drive is on a vertical surface with adequate space for air circulation (4.75" above and below, 1.2" on each side). Refer to Fig 1.8.
- 6. Verify that the proper branch circuit protection is installed in front of the Drive. Refer to Appendix E - Peripheral Devices for proper input fuse or circuit breaker sizing.

- 7. Avoid running input and output wiring in the same conduit.
- 8. Avoid routing power wiring near equipment sensitive to electrical noise.
- 9. Never allow wire leads to touch metal surfaces. Short-circuit may result.
- 10. Never connect AC main power to output terminals U/T1, V/T2 and W/T3.
- 11. Never connect power factor correction capacitors or noise filters to the Drive output.
- 12. Use 600Vac vinyl-sheathed wire or equivalent. Wire size should be determined considering voltage drop of leads.  
Line voltage drop (V) =  $\sqrt{3}$  x wire resistance ( $\Omega$ /km) x wire length (m) x current (A) x  $10^{-3}$
- 13. It is recommended that the motor lead length not exceed 164 feet (50 meters) and motor wiring be run in a separate conduit from the power wiring. If lead length must exceed this distance, reduce the carrier frequency (See Table 2.6) and consult Yaskawa toll free at 1-800-YASKAWA (927-5292) for other motor protection measures.
- 14. Signal and control leads must be separated from main circuit leads (R/L1, S/L2, T/L3, U/T1, V/T2, W/T3).
- 15. Determine proper wire size for power and motor leads. Refer to Tables 2.1 and 2.2 for details.
- 16. Review proper ground connections for the Drive. Refer to Chapter 2 – Electrical Installation for details. The Drive must be solidly grounded using the main circuit ground terminal. Ground resistance should be less than  $100\Omega$  for a 208-240Vac Drive. Ground resistance should be less than  $10\Omega$  for a 480Vac Drive. Select wire size suitable for the size of terminal screw. Make the length as short as possible.

Never ground the drive in common with welding machines, motors or other large-current electrical equipment.

Where several Drives are used, ground each Drive directly or daisy-chain to the ground pole(s).  
DO NOT FORM A LOOP WITH THE GROUND LEADS. See Figure 2.4.

- 17. Review terminal functions of signal and control circuits. Refer to Table 2.8.
- 18. Verify if any customer safety devices are required (e.g. firestat, freezestat, high static pressure).
- 19. Record the following motor nameplate information:  
Voltage: \_\_\_\_\_ Motor Rated Amps: \_\_\_\_\_
- 20. Verify that the commercial power supply is within the rated Drive input voltage:  
Power Supply: \_\_\_\_\_ VAC      Drive Input Voltage: \_\_\_\_\_ VAC
- 21. Verify that the leads in the 3-Phase electric motor conduit box are configured for the proper voltage.
- 22. Ensure Motor Rated Current is less than or equal to Drive Output Amps. If multiple motors are being used, make sure that the Motor Rated Current sum is less than or equal to Drive Output Amp rating. Please note that if multiple motors are being operated from one Drive, each motor must have its own overload and short circuit protection.

- 23. Wire all necessary power leads to the Drive. ***DO NOT CONNECT MOTOR TO DRIVE YET.***
- 24. Wire all necessary ground wires to the Drive.
- 25. Wire all necessary control wires to the Drive.
- 26. Ensure that the power leads are connected to the R/L1, S/L2 and T/L3 terminals in the Drive.
- 27. Tighten all of the three-phase power and ground connections. Please check that all control and signal terminations are tight.
- 28. Inspect the control circuit connections (including the shield) and determine if a motor “safety circuit” is connected.

If normally closed, these contacts may be wired in series with the **RUN** command contacts, which are between terminals **S1** and **SN** of the Drive. No special programming is required. Refer to Chapter 2 – Electrical Installation (Fig. 2.7).

Alternately, these contacts could be wired between terminals **S3** and **SN** as **External Fault Inputs**, and may be either normally closed or normally open contacts.

- 29. Record any other connections to the Drive using the blank terminal connection drawing in Chapter 2 – Electrical Installation (Fig. 2.9) to determine if special programming is required for the following:
  - Multi-function Inputs – refer to Appendix A – Parameter List
  - Multi-function Outputs – refer to Appendix A – Parameter List
  - Multi-function Digital Inputs – refer to Appendix A – Parameter List
  - Multi-function Analog Outputs – refer to Appendix A – Parameter List
  - Serial Communications – refer to Appendix A – Parameter List

**THIS COMPLETES THE DRIVE START UP PREPARATION.**

# DRIVE START UP PROCEDURES

- 1. Confirm that all three phases are present and that the input voltage is correct for the Drive being set up. Measure the voltage on the line side of the Drives Molded Case Circuit Breaker/disconnect and record below.

Measurement Location	Voltage (Vac)
L1 – L2	
L2 – L3	
L1 – L3	

**WARNING**

Use extreme caution when performing measurements as contact with live parts may result in personal injury or death.

- 2. If voltage level is within Drive Specification (See Appendix C - Specification), **APPLY POWER** to energize the Drive. The **STOP**, **AUTO SEQ** and **AUTO REF** indicators should be on.
- 3. **REMOVE POWER** from the Drive. Wait for the Red **CHARGE LED** (near the power terminals) to go out.

**WARNING**

The internal capacitor remains charged even after the power supply is turned off. The status indicator LED's and the digital operator display will be extinguished when the DC bus voltage is below 50VDC. To prevent electric shock, wait at least 5 minutes after all indicators are off and measure the DC Bus voltage level to confirm a safe level prior to working on the Drive.

- 4. Connect the motor leads to the Drive at terminals U/T1, V/T2 and W/T3.
- 5. **APPLY POWER** to the Drive.
- 6. Press the **HAND** key once. This puts the Drive in the Hand Mode, allowing run/stop and speed commands (frequency references) by the digital operator. The **AUTO SEQ** and **AUTO REF** indicators turn off. The **FWD** light turns on. The **RUN** light turns on. The **STOP** light is blinking. “Frequency Ref” (U1-01) is now displayed on the Digital Operator.
- 7. Press the **OFF** key.
- 8. Press the **MENU** key two times. Press the **DATA/ENTER** key once to enter the Quick Setting Menu. Press the **▼** key 25 times to display parameter E1-01 “Input Voltage”. This parameter selects the nominal input voltage the Drive will receive. To set this parameter for the application. Press the **DATA/ENTER** key once. Use the **▲**, **▼**, and **►** keys and the **DATA/ENTER** key to set this parameter per the application.

Parameter No.	Parameter Name Digital Operator Display	Setting Range	Factory Setting	Menu Location
E1-01	Input Voltage Setting <b>Input Voltage</b>	155.0 to 255.0 (208-240Vac)	240.0 (208-240Vac)	Quick Setting or Programming
		310.0 to 510.0 (480Vac)	480.0 (480Vac)	

Ensure the **DATA/ENTER** key is pressed to enter the selection in the Drive. “Entry Accepted” briefly appears and the display is now no longer flashing.

- 9. Press the ▲ key once to display E2-01 “Motor Rated FLA”.

This parameter is the foundation of motor protection. It can be entered when auto-tuning is performed. Set this parameter according to the motor rated current (FLA). Press the **DATA/ENTER** key once. Use the ▲, Å•, and ► keys to adjust E2-01 to the motor rated full load amps.

Parameter No.	Parameter Name Digital Operator Display	Setting Range	Factory Setting	Menu Location
E2-01	Motor Rated Current <b>Motor Rated FLA</b>	kVA Dependent	kVA Dependent	Quick Setting or Programming

Ensure the **DATA/ENTER** key is pressed to enter the value in the Drive. “Entry Accepted” briefly appears and your display is now flashing.

- 10. Press the ESC once. Press DATA/ENTER once. Press ▲ key twice to display b1-02 “Run Source”. This parameter selects where the Drive will receive the run command. Press the **DATA/ENTER** key once. Use the ▲ or Å• keys and the **DATA/ENTER** key to set this parameter for the application.

Parameter No.	Parameter Name Digital Operator Display	Setting Choices	Setting Range	Factory Setting	Menu Location
b1-02	Run Command Selection <b>Run Source</b>	0: Operator 1: Terminals 2: Serial Com 3: Option PCB	0 - 3	1	Quick Setting or Programming

Ensure the **DATA/ENTER** key is pressed to enter the selection in the Drive. “Entry Accepted” briefly appears and the display is now not flashing.

- 11. Press the Å• key once to display b1-01 “Reference Source”. This parameter selects where the Drive will receive the speed command. Press the **DATA/ENTER** key once. Use the ▲ or Å• keys and the **DATA/ENTER** key to set this parameter for the application.

Table 4.5 Speed Command Selection					
Parameter No.	Parameter Name Digital Operator Display	Setting Choices	Setting Range	Factory Setting	Menu Location
b1-01	Frequency Reference Selection <b>Reference Source</b>	0: Operator 1: Terminals 2: Serial Com 3: Option PCB	0 - 3	1	Quick Setting or Programming

Ensure the **DATA/ENTER** key is pressed to enter the selection in the Drive. “Entry Accepted” briefly appears and the display is now not flashing.

- 12. Press the **▲** key twice to display b1-03 “Stopping Method”.

This parameter selects the stopping method used when a stop command is given to the Drive.

Table 4.6 Stopping Method Selection					
Parameter No.	Parameter Name Digital Operator Display	Setting Choices	Setting Range	Factory Setting	Menu Location
b1-03	Stopping Method Selection <b>Stopping Method</b>	0: Ramp to Stop 1: Coast to Stop 2: DCInj to Stop 3: Coast w/Timer	0 - 3	0	Quick Setting or Programming

Press the **DATA/ENTER** key once. Use the **▲** or **▲•** keys to select the stopping method. Ensure the **DATA/ENTER** key is pressed to enter the selection in the Drive. “Entry Accepted” briefly appears and the display is not flashing.

- 13. Press the **MENU** key once to display “Operation”.
- 14. Press the **DATA/ENTER** key once to display “Frequency Ref”.
- 15. The **STOP** and **FWD** lights are on.
- 16. Press the **DATA/ENTER** key once to enable entering of a speed command in U1-01. Use the **▲** and **▲•** keys to set a speed command of 6.00Hz.
- 17. Press the **HAND** key once to start the motor and verify correct motor rotation for the application. The **RUN** light turns on and the **STOP** light turns off.

If the direction of motor rotation is wrong, press the **OFF** key. The **RUN** light turns off and the **STOP** light turns on. **REMOVE POWER** from the Drive. Wait for the Red CHARGE LED (near the power terminals) to go out. When it does, swap the motor wires connected to terminals **U/T1** & **V/T2** in the Drive. Be sure to re-tighten the terminal lugs. **APPLY POWER**.

To verify the motor rotation is now correct for the application, press the **HAND** key once to start the motor and turn off the **AUTO SEQ** and **AUTO REF** lights. The **FWD** light turns on and the motor will rotate at the speed entered in step 16.

- 18. Press the **MONITOR** key to display the U1 monitors. Use the **▲** and **▲•** keys to view Output Current (U1-03), Output Voltage (U1-06), and DC Bus Voltage (U1-07) while running the Drive throughout its entire speed range. Record the following information at each speed:

Frequency (Hz) Monitor U1-01	Output Current (A) Monitor U1-03	Output Voltage (VAC) Monitor U1-06	DC Bus Voltage (VDC) Monitor U1-07
6.0			
10.0			
15.0			
20.0			
25.0			
30.0			
35.0			
40.0			
45.0			
50.0			
55.0			
60.0			

When this table is complete, press the **OFF** key. The Drive will stop and the **FWD** light remains on. This step provides benchmark data for the application from the initial start up.

- 19. Press the **MENU** key once to display “Operation”. Press the **DATA/ENTER** key to display “Frequency Ref”. If using a remote speed command, press the **AUTO** key so the **AUTO SEQ** and **AUTO REF** indicators are on. This puts the Drive in Auto mode.
- 20. If using an external speed command, determine whether the speed command is a 0-10Vdc or a 4-20mA signal. Connect the positive side of a 0-10Vdc signal to terminal **A1**. Connect the positive side of a 4-20mA signal to terminal **A2**. Connect the **COMMON** of the speed command to terminal **AC**.

Note: Connect only one input. The factory default is 0-10Vdc. To change to 4-20mA adjust parameter H3-08 to “2:4 – 20mA” and ensure DIP Switch S1-2 (located on the terminal board) is in the ON position.

- 21. Check the signal for proper polarity. Observe if the speed command can achieve the minimum and maximum speeds desired. If not, perform the following:

For 0-10Vdc input (Terminal **A1**)

1. With no input, adjust Bias (**H3-03** setting) until an output of “0.0 Hz” is obtained.
2. With full-scale input, adjust Gain (**H3-02** setting) until an output of “60.0 Hz” (or other desired maximum frequency) is obtained.

For 4-20mA input (Terminal **A2**)

1. With 4mA input, adjust Bias (**H3-11** setting) until an output of “0.0 Hz” is obtained.
2. With 20 mA input, adjust Gain (**H3-10** setting) until an output of “60.0 Hz” (or other desired maximum frequency) is obtained.

**THIS COMPLETES THE DRIVE START UP PROCEDURE.**

Notes:

# Chapter 5

## Basic Programming

---

*This Manual contains descriptions of all user accessible parameters contained in the Drive. Parameters are listed in alpha-numerical order. Parameter number and name, along with a detailed description and its settings are described on the following pages.*

A1 Initialization.....	5-2
b1 Sequence.....	5-4
b2 DC Braking .....	5-9
b3 Speed Search .....	5-11
b5 PI Function.....	5-15
b8 Energy Savings.....	5-24
C1 Accel/Decel .....	5-25
d2 Reference (Speed Command) Limits.....	5-26
d3 Jump Frequencies .....	5-27
E1 V/f Pattern .....	5-28
E2 Motor Setup.....	5-31
F6 Com OPT Setup .....	5-32
H3 Analog Inputs .....	5-33
L2 Momentary Power Loss Ride-thru Function.....	5-39
L3 Stall Prevention.....	5-40
L4 Speed Command Loss Detection .....	5-43
L5 Fault Restart .....	5-44
L6 Torque Detection.....	5-46
L8 Hardware Protection .....	5-48
o1 Monitor Configuration .....	5-50
o2 Key Selections .....	5-54
o3 Digital Operator Copy Function .....	5-56
T1 Auto-Tuning .....	5-59

# E7 Basic Programming Parameters

The initialization group contains parameters associated with initial set-up of the Drive. Parameters involving the display language, access levels, initialization and password are located in this group.

---

## ◆ A1 Initialization

### ■ A1-00 Select Language

Setting	Description
0	English ( <i>factory default</i> )
1	Japanese
2	Deutsch
3	Francais
4	Italiano
5	Espanol
6	Portugues

The setting of parameter A1-00 determines which international language the Drive will use to display non-numerical text. The A1-00 parameter will not be changed by an Initialization of the drive (A1-03= “1110: User Initialize”, “2220: 2-Wire Initial”, or “3330: 3-Wire Initial”).

If the Drive is accidentally set to a language unfamiliar to the operator, locating the parameter to change the operator language can be done by performing the following:

1. Press the MENU key until the “-ADV-” MENU is shown in the upper left corner of the digital operator.
2. Press the DATA/ENTER key to enter the programming menu. The first parameter shown is A1-00 (Select Language).
3. Press the DATA/ENTER key again and use the INCREASE and DECREASE arrow keys to choose the preferred language from the list below:

0 : English  
1 : Japanese  
2 : Deutsch (German)  
3 : Francais (French)  
4 : Italiano (Italian)  
5 : Español (Spanish)  
6 : Portugues (Portuguese)

### ■ A1-01 Access Level Selection

Setting	Description
0	Operation Only
1	User Level
2	Advanced Level ( <i>factory default</i> )

A1-01 can be used to allow access to and permission to change all Drive parameters. If the Drive is programmed for Operation Only (A1-01= “0: Operation Only”), then only the OPERATION and the PROGRAMMING menus are accessible. Within the PROGRAMMING menu only parameters A1-01 and A1-04 are adjustable.

If A1-01 is configured for Advanced Access (A1-01= “2: Advanced Level”), then all menus and all parameters are shown. If the Access Level Selection is set to Advanced, all parameters should be adjustable unless:

1. The Drive parameters are password protected (A1-04) which will prevent access to A1-00 through A1-03 and all A2 parameters.
2. A digital input has been configured as a Program Lockout (H1-0X= 1B) is active.
3. During serial communication writing, if a parameter change is also attempted via the digital operator, a “BUSY - WRITE PROTECTED” message will display. Parameter change will not be possible from the digital operator until an Enter command is received via the serial communication to finish the serial writing process.

### ■ A1-03 Initialize Parameters

Setting	Description
0	No Initialize ( <i>factory default</i> )
1110	User Initialize
2220	2-Wire Initialize
3330	3-Wire Initialize

The Drive can be set back to one of three default states via the A1-03 parameter.

1. User Initialization – 1110: The modified Drive parameters are returned to the values selected as user settings. User settings are stored when parameter o2-03= “1: Set Defaults”.
2. 2-Wire Initialization – 2220: The Drive parameters are returned to factory default values with digital inputs S1 and S2 configured as Forward Run and Reverse Run, respectively.
3. 3-Wire Initialization – 3330: The Drive parameters are returned to factory default values with digital inputs S1, S2, and S5 configured as Run, Stop, and Forward/Reverse respectively.

After an initialization is performed, parameter A1-03 will automatically be set back to 0.

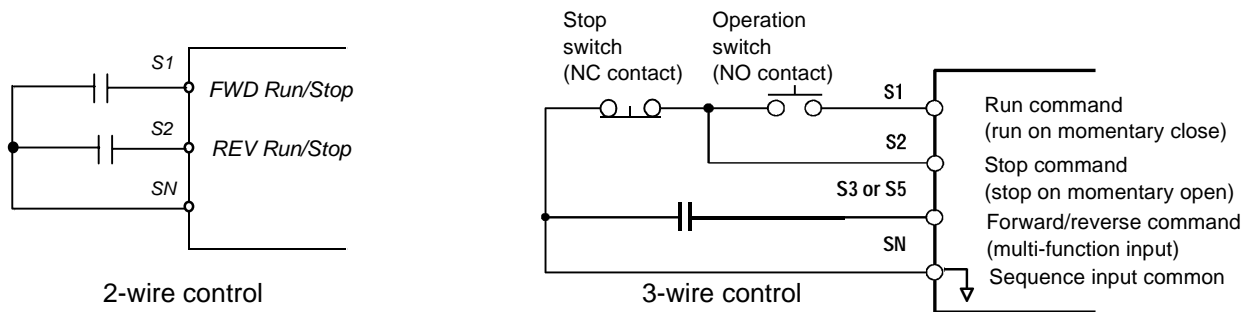

Fig. 1 2 & 3-Wire Control Wiring Examples

#### IMPORTANT

Some parameters are unaffected by either the 2-Wire or 3-Wire initialization. The following parameters will not be reset when parameter A1-03=2220 or 3330:

- |       |  |
|-------|--|
| A1-00 | Language Selection                     |
| E1-03 | V/f Pattern Selection                  |
| o2-04 | kVA Selection                          |
| o2-09 | Initialization Specification Selection |

---

## ◆ b1 Sequence

The Sequence Group contains parameters associated with starting and stopping the Drive. Parameters involving the Run Command, Speed Reference location, Stopping Method and Hand/Auto changeover are located in this group.

### ■ b1-01 Reference (Speed Command) Source Selection

Setting	Description
0	Operator - Digital Preset Speed d1-01
1	Terminals - Analog Input Terminal A1 (or Terminal A2, see Parameter H3-13)
2	Serial Com - RS-485 Terminals R+, R-, S+ and S-
3	Option PCB - Option Board connected at 2CN

In order to run the Drive and motor, the Drive must receive a Run command and a speed command. Parameter b1-01 specifies from where the speed command is received when in the “Auto mode. Switching into the “Auto” mode can be done by pressing the AUTO button on the digital operator while the Drive is stopped.

#### IMPORTANT

If a Run command is input to the Drive but no corresponding speed command is input, the Run indicator on the digital operator will turn on and the STOP indicator on the digital operator will blink.

**If you want the Drive to follow the speed command set by the digital operator:** Use the “Hand” mode by pressing the hand key or set b1-01= “0: Operator”. The speed command can then be entered into the U1-01 monitor parameter in the “-DRIVE-” Menu.

**If you want the Drive to follow an “Auto” analog speed command:** Set b1-01= “1: Terminals”, and connect a 0 – 10 Vdc speed command signal between terminals A1 and AC or a 4 – 20 mA speed command signal to terminals A2 and AC.

**If you want the Drive to receive the speed command from serial communication:** Set b1-01= “2: Serial Com”, and connect the RS-485/422 serial communications cable to terminals R+, R-, S+, and S- on the control I/O terminal block.

**If you want to use LONWORKS® to input a speed command:** Set b1-01= “3: Option PCB”, and plug a LONWORKS® option board (p/n SI-J) into the 2CN port on the Drive Control PCB. Consult the manual supplied with the option board for instructions on integrating the Drive into the LONWORKS® System.

#### IMPORTANT

If b1-01= “3: Option PCB” but a LONWORKS® card is not installed in 2CN, an OPE05 Operator Programming Error will be displayed on the digital operator and the Drive will not run.

### ■ b1-02 Run Source

Setting	Description
0	Operator
1	Terminals ( <i>factory default</i> )
2	Serial Com
3	Option PCB

To successfully operate the Drive remotely, an external run command must be received by the Drive. Parameter b1-02 specifies from where the run command will be accepted.

Although the Run Source and the Reference Source (b1-01) are normally taken from the same source (e.g. digital operator, terminals or serial communication), this is not always the case.

**To issue a run command from the digital operator:** Set b1-02= “0: Operator”, and use the HAND and OFF buttons to start and stop the Drive.

**To issue the run command from the terminals:** Set b1-02= “1: Terminals”, and select between 2-wire and 3-wire control operation by doing the following:

**2-Wire Control** The factory default setting is for 2-wire operation. In the 2-wire configuration a closure between S1 and SN will be interpreted as a Forward Run command by the Drive. A closure between S2 and SN will be interpreted as a Reverse Run command. If both S1 and S2 are closed, the Drive will stop (decelerate to zero speed) and the digital operator will display an EF (external fault) alarm (Flashing).

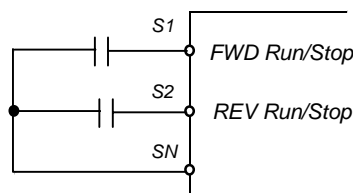

Fig. 2 2-Wire Control

**3-Wire Control** When any of the multi-function digital input parameters, H1-01 through H1-05, is set to 0, terminals S1 and S2 become Run and Stop, respectively. The multi-function digital input that was set to 0 will function as a Forward/Reverse input for the Drive. When the Forward/Reverse input is open the Drive will run in the Forward direction and when the input is closed, the Drive will run in the Reverse direction.

In 3-wire operation a momentary closure (> 50mS) of S1 will cause the Drive to run provided that S2 is held closed. The Drive will stop anytime the S2-SN connection is broken. If the 3-wire configuration is implemented via a 3-wire Initialization (A1-03= “3330: 3-Wire Initial”), then terminal S3 becomes the Forward/Reverse input.

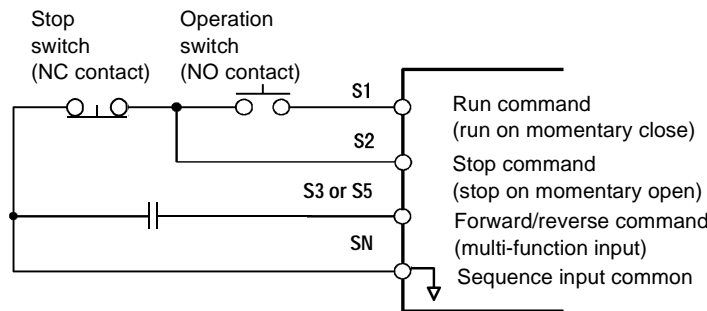

Fig. 3 3-Wire Control

**To issue a run command via serial communication:** Set b1-02= “2: Serial Com” and connect the RS-485/422 serial communication cable to R+, R-, S+, and S- on the removable terminal block.

**To issue the Run command via the LONWORKS® option card:** Set b1-02= “3: Option PCB”, and plug a LONWORKS® option board (p/n SI/J) into the 2CN port on the Control PCB. Consult the manual supplied with the option board for instructions on integrating the Drive into your LONWORKS® System.

**IMPORTANT**

If b1-01= “3: Option PCB” but a LONWORKS® card is not installed in 2CN, an “OPE05” operator programming error will be displayed on the digital operator and the Drive will not run.

### ■ b1-03 Stopping Method

There are four methods of stopping the Drive when the Run command is removed.

Setting	Description
0	Ramp to Stop ( <i>factory default</i> )
1	Coast to Stop
2	DC Injection to Stop
3	Coast w/Timer

**“0:Ramp to stop”:** When the Run command is removed, the Drive will decelerate the motor to 0 rpm. The rate of deceleration is determined by the active deceleration time. The factory default Decel Time is in parameter C1-02. When the output frequency has dropped below the DC Injection Start Frequency in b2-01 (Default = 0.5HZ) DC current will be injected in the motor at a level determined by b2-02 (50% Default). The DC Injection condition will occur for the time specified by b2-04 (0.0 Default), to establish the end point of the ramp. DC injection can be used to insure the motor is at zero rpm prior to the Drive shutting off.

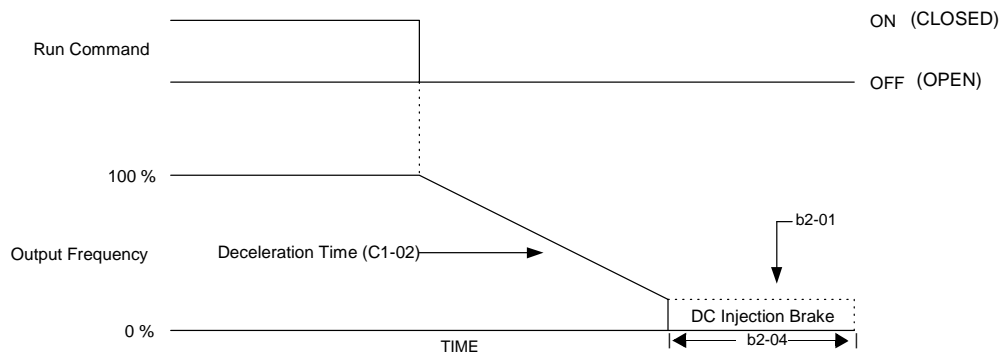

Fig. 4 Deceleration to Stop

The actual deceleration time can be determined by the following formula

$$\text{Time to Stop} = \frac{\text{Output Freq. at time of stop command}}{\text{Maximum Frequency (E1 - 04)}} \times \text{Setting of active Decel Time (C1 - 02 or C1-04)}$$

If S-Curve characteristics are specified by the Drive programming, they will add to the total time to stop.

**“1:Coast to stop”:** When the Run command is removed, the Drive will turn off its output and the motor will coast (uncontrolled deceleration). The friction of the driven equipment will eventually overcome any residual inertia of the system and the rotation will stop.

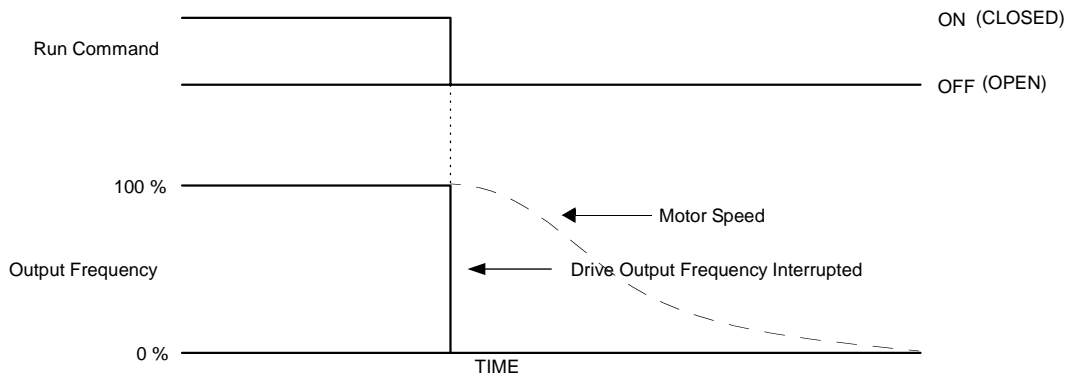

Fig. 5 Coast to Stop  
Programming 5 - 6

**IMPORTANT**

After a stop is initiated, a subsequent Run commands input before the Minimum Baseblock Time (L2-03) has expired, will be ignored.

**2: DCInj to Stop:** When the Run command is removed, the Drive will Baseblock (turn off its output) for the Minimum Baseblock Time (L2-03). Once the Minimum Baseblock Time has expired, the Drive will inject DC current into the motor windings to lock the motor shaft. The stopping time will be reduced as compared to Coast to Stop. The level of DC Injection current is set by parameter b2-02 (50% Default). The DC Injection brake time is determined by the set value in b2-04 and the output frequency at the time the Run command is removed.

$$\text{DC Injection Brake Time} = \frac{(b2 - 04) \times 10 \times \text{Output Frequency}}{\text{Maximum Frequency (E1 - 04)}}$$

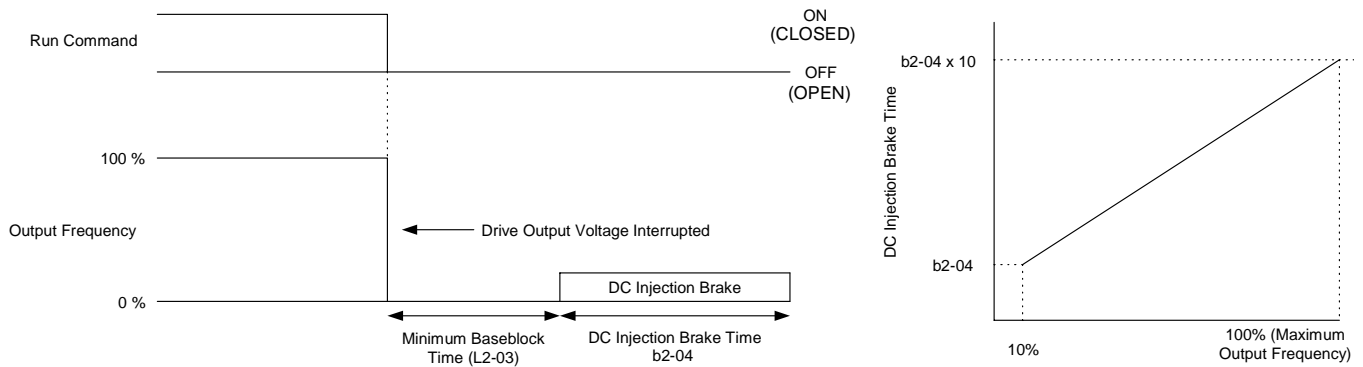

Fig. 6 DC Injection Braking to Stop

**IMPORTANT**

If an overcurrent (OC) fault occurs during DCInj to Stop, lengthen the Minimum Baseblock Time (L2-03) until the fault no longer occurs.

**3: Coast w/Timer:** When the Run command is removed, the Drive will turn off its output and the motor will coast to a stop. If a Run command is input before time T (operation wait time) expires, the Drive will not run and the Run command will need to be cycled before operation can occur. The time T (operation wait time) is determined by the output frequency when the Run command is removed and the active deceleration time (C1-02).

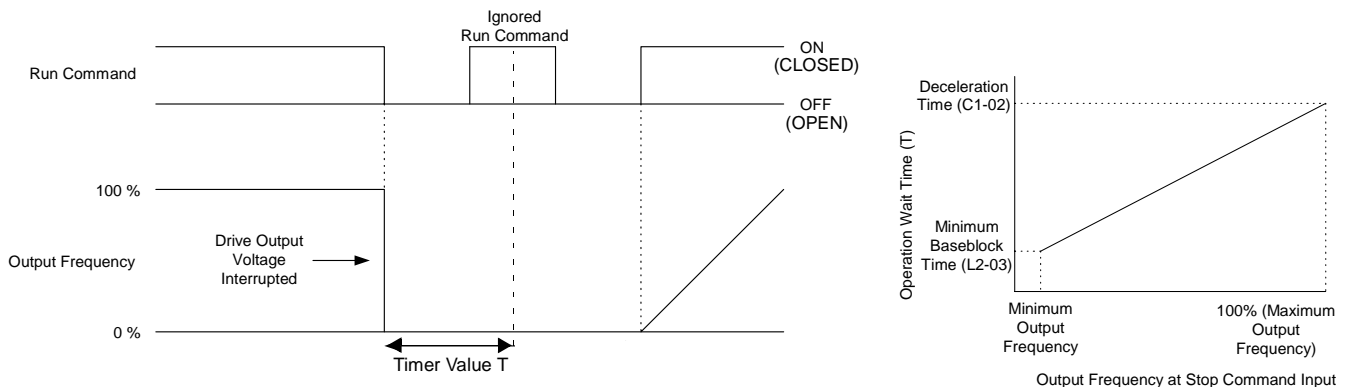

Fig. 7 Coast to Stop with Timer

## ■ b1-04 Reverse Operation

Setting	Description
0	Reverse Enabled
1	Reverse Disabled ( <i>factory default</i> )
2	Exchange Phase
3	ExchgPhs, Rev Dsbl

For some applications reverse motor rotation is not applicable and may even cause problems (e.g., air handling units, pumps, etc.). Setting parameter b1-04 to 1 or 3 will cause the Drive to ignore any inputs for reverse operation. Setting parameter b1-04 to either 2 or 3 will change the motor shaft rotation when a Forward Run command is given by exchanging the order of the output phasing.

The factory default setting of parameter b1-04 is “1: Disabled”. When b1-04= “1: Disabled”, reverse operation is prohibited and no exchanging of output phasing occurs.

Drive terminal S2 is a dedicated input for reverse Run/Stop.

## ■ b1-07 Local/Remote Run Selection

Setting	Description
0	Cycle Extern Run ( <i>factory default</i> )
1	Accept Extrn Run

When the Drive is switched between the Local (Hand) mode (the digital operator) to the Remote (Auto) mode (determined by b1-01 and b1-02), there is the possibility that a Run command is already present (i.e. a contact closure between S1 and SN when b1-02= “1: Terminals”). Parameter b1-07 determines whether the Drive will:

Ignore the external Run command until it is removed and re-instated (b1-07= “0: Cycle Extern Run”)

OR

Accept the already present Run command and immediately begin acceleration to the commanded speed (b1-07= “1: Accept Extrn Run”).

### IMPORTANT

When switching from local mode to Auto mode when b1-07=“1: Accept Extrn Run” the Drive may start unexpectedly if the Run command is already applied. Be sure all personnel are clear of rotating machinery and electrical connections prior to switching between local mode and Auto mode.

## ■ b1-08 Run Command Selection During Programming

Setting	Description
0	Disabled ( <i>factory default</i> )
1	Enabled

As a safety precaution, the Drive will not normally respond to a Run input when the digital operator is being used to adjust parameters. If it is necessary that external Run commands be recognized even while the Drive is being programmed, set b1-08= “1: Enabled”.

## ■ b1-11 Drive Delay Time Setting

Setting Range: 0 to 600 Seconds

Factory Default: 0 Seconds

If a time is set into parameter b1-11, the Drive will delay executing any run command until the b1-11 time has expired. During Drive delay time execution, the digital operator will display:

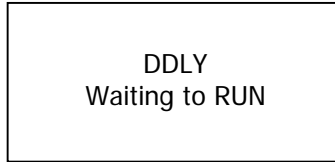

Both the ALARM and Run indicators will blink while the Drive waits to execute the Run command.

## ■ b1-12 Hand Frequency Reference Selection

Setting	Description
0	Operator ( <i>factory default</i> )
1	Terminals

When the Drive is put into the HAND mode, by pressing the HAND key while in Operation, the Speed Command will be set via the digital operator by default. If it is desirable to have the Speed Command input from the terminals instead of the digital operator, set b1-12= "1: Terminals".

### IMPORTANT

When the Speed Command is set via the terminals, parameter H3-13 will determine whether analog input terminal A1 or A2 is the Speed Command.

---

## ◆ b2 DC Braking

The DC Braking Group contains parameters associated with the DC injection braking feature. Parameters involving the starting frequency, current level, braking time, and motor pre heat current level are located here.

### ■ b2-01 DC Injection Braking Start Frequency

Setting Range: 0.0 to 10.0 Hz

Factory Default: 0.5 Hz

Parameter b2-01 sets the output frequency where the Drive begins DC Injection during Ramp to stop, in order to lock the rotor of the motor and established the end point of the ramp. If b2-01 < E1-09 (Minimum Frequency), then DC Injection begins at E1-09.

Parameter b2-01 also determines the output frequency that the Drive must be at or below before a Zero Speed condition is considered true. This affects any digital output configured as a Zero Speed signal (H2-0x= "1: Zero Speed").

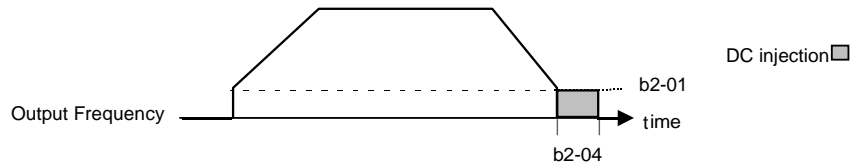

Fig. 8 DC Injection Braking During Stopping

■ **b2-02 DC Injection Braking Current**

Setting Range: 0 to 100%

Factory Default: 50%

The level of DC Injection Braking Current affects the strength of the magnetic field attempting to lock the motor shaft. Increasing the level of current will increase the amount of heat generated by the motor windings and should only be increased to the level necessary to hold the motor shaft. DC Injection current is set in percentage of Drive rated output current. Drive rated output current is stated on the Drive nameplate.

■ **b2-03 DC Injection Braking Time at Start**

**b2-04 DC Injection Braking Time at Stop**

Setting Range: 0.00 to 10.00 Seconds

Factory Default: 0.00 Seconds

The Drive can be programmed to automatically DC Inject for a predetermined amount of time prior to accelerating to speed (b2-03) and/or at the end of a Ramp to stop (b2-04). Parameter b2-03 can be used to stop a rotating motor prior to attempting acceleration (i.e. a wind milling fan). If DC Injection braking at start or Speed Search is not enabled, attempting to drive a spinning motor may cause nuisance tripping.

Parameter b2-04 can be used to resist any residual motion of the load after the deceleration has finished.

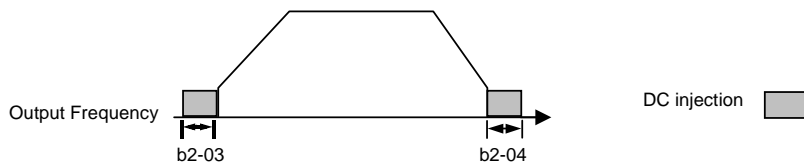

Fig. 9 DC Injection Braking During Starting and Stopping

Parameter b2-04 also serves the function of affecting the length of time DC Injection to stop (b1-03= “2: DC Injection to Stop”) will occur.

## ■ b2-09 Motor Pre-Heat Current

Setting Range: 0 to 100%

Factory Default: 0%

A DC current can be circulated within the motor windings while the motor is stopped. The current will produce heat within the motor and prevent condensation. Parameter b2-09 determines the percentage of Drive rated output current that will be used for the motor pre-heat function. This function can be useful in applications where the motor sits for extended periods of time in humid conditions. Motor pre-heating can only be initiated by closing a digital input programmed as a Motor Pre-heat Input (H1-0x= 60). Check with the motor manufacturer to determine the maximum acceptable current level the motor can withstand when stopped. Be sure not to exceed the motor manufacturers recommended level.

---

## ◆ b3 Speed Search

The Speed Search function allows the Drive to determine the speed of a motor shaft that is being driven by rotational inertia. Speed Search will allow the Drive to determine the speed of the already rotating motor and begin to ramp the motor to a set speed without first having to bring it to a complete stop. When a momentary loss of supply power is experienced, the Drive output is turned off. This results in a coasting motor. When power returns, the Drive can determine the speed of the coasting motor and start without requiring it to be brought to minimum speed. Speed Search can be programmed to always be active by setting b3-01 or it can be commanded by remote contact closure by setting a digital input.

There are two forms of Speed Search in the Drive, the speed estimation method and the current detection method.

### IMPORTANT

When setting the Drive for remote Speed Search input, via a contact closure, the method of Speed Search is determined by the setting of b3-01. If b3-01= "0: SpdsrchF Disable" then the remote input will initiate speed estimation method, and if b3-01= "2: SpdsrchI Disable", then the remote input will start the current detection method.

Parameters L2-03 and L2-04 also affect the current detection method of Speed Search operation.

## ■ b3-01 Speed Search Selection

This parameter is effective only when the Drive is given a new "RUN" command.

Setting	Description
0	SpdsrchF Disable
1	SpdsrchF Enable
2	SpdsrchI Disable ( <i>factory default</i> )
3	SpdsrchI Enable

**Speed Estimation: Method (b3-01= 0 or 1)** The speed estimation method will calculate the speed using measurements of residual motor fields. The speed estimation version is bi-directional and will determine both the motor speed and direction. To enable speed estimation Speed Search at start, set b3-01= "1: SpdsrchF Enable".

### IMPORTANT

If the speed estimation method of Speed Search is to be used, then Auto-tuning must be performed prior to using Speed Search. If the length of cable between the Drive and motor is ever changed after Auto-tuning then Auto-tuning should be performed again.

**IMPORTANT**

The speed estimation mode cannot be used when there are multiple motors operated by one Drive or the motor is two or more frames smaller than the standard size motor per the Drive capacity.

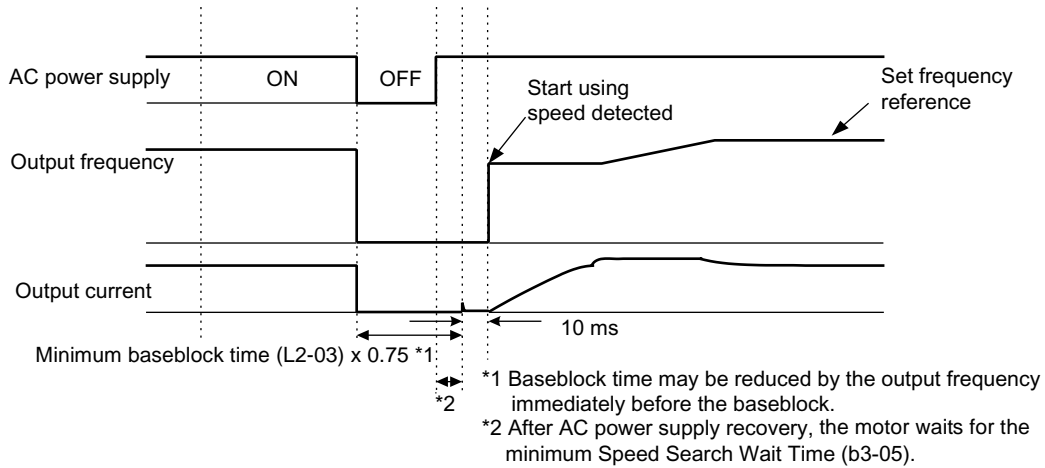

Fig. 10 Speed Search (Estimated Speed Method) after momentary power loss where the power loss time is less than the minimum baseblock time

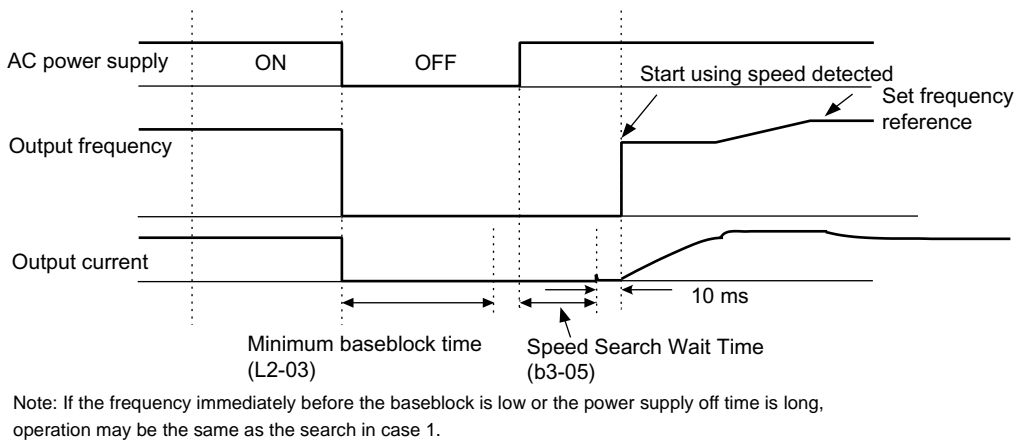

Fig. 11 Speed Search (Estimated Speed Method) after momentary power loss where the power loss time exceeds the minimum baseblock time

**Current Detection Method (b3-01=2 or 3):** The current detection method starts searching from a predetermined frequency while monitoring the Drive output current to determine when the rotor speed and the Drive output speed (frequency) match. The current detection version is not bi-directional. To enable current detection Speed Search at start set b3-01= “3: SpdsrchI enable” and program any digital input equal to Speed Search 1 (H1-0x= 61) or Speed Search 2 (H1-0x= 62). Speed Search 1 will start searching from the max. frequency (E1-04) and ramp down to meet the rotor speed. Speed Search 2 will start searching from the set frequency and ramp down to meet the rotor speed.

**IMPORTANT**

If a UV1 fault occurs when current detection Speed Search is attempted, increase the setting of L2-04

**IMPORTANT** | If an OC fault occurs when Speed Search is attempted after power loss recovery, increase the setting of L2-03.

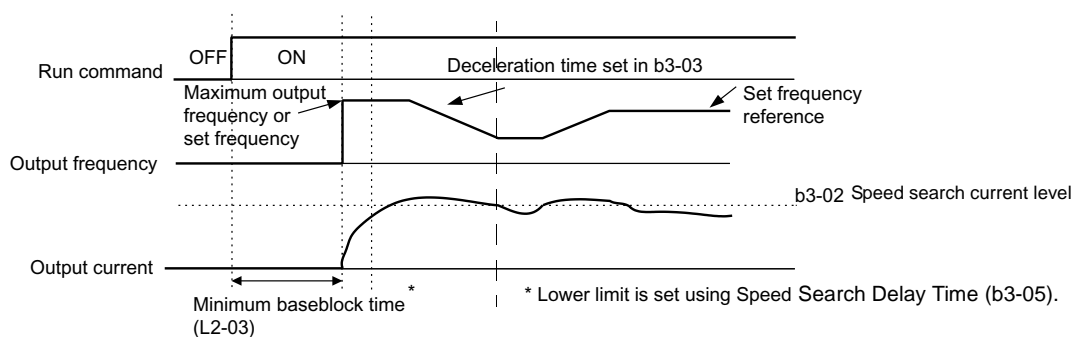

Fig. 12 Speed Search (Current Detection Method) at Startup

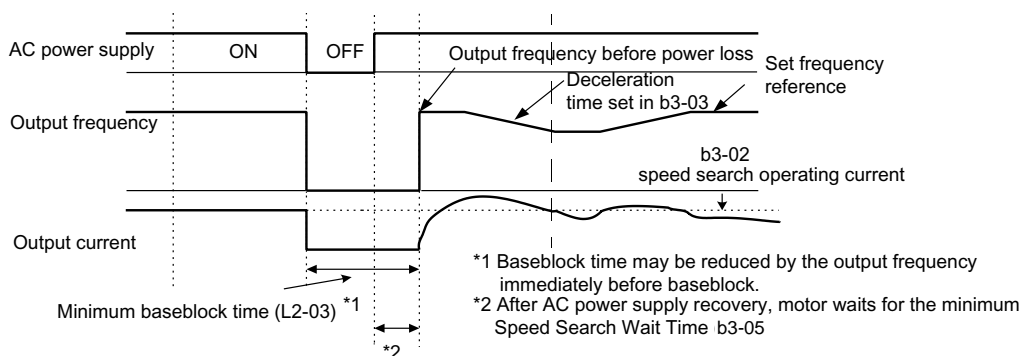

Fig. 13 Speed Search (Current Detection Method) after momentary power loss where the power loss time is less than the minimum baseblock time

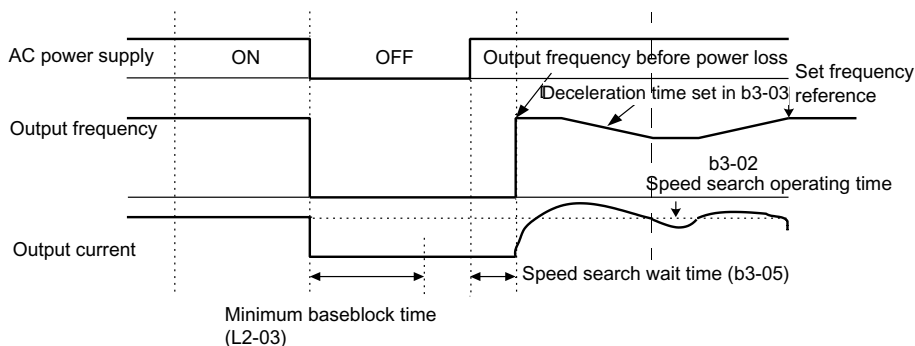

Fig. 14 Speed Search (Current Detection Method) after momentary power loss where the power loss time exceeds the minimum baseblock time

Setting of b3-01	Automatic Speed Search for all RUN commands and momentary power loss	Speed Search Method Used for Multi-function inputs
0	No	Speed Estimation
1	Yes - Speed Estimation	
2	No	Current Detection
3	Yes - Current Detection	

### ■ b3-02 Speed Search Deactivation Current

Setting Range: 0 to 200% of Drive rated output current

Factory Default: 120% of Drive rated output current

When using the current detection method of Speed Search, parameter b3-02 sets the current level that will determine when the search is complete and the rotor and output speeds match. When the output frequency is higher than the actual rotor speed the slip causes the current to be high. As the output frequency is lowered, the closer it comes to the rotor speed, the lower the current draw will be. When the output current drops below the level as set in b3-02 (100% = Drive Rated Current) the output frequency stops decreasing and normal operation resumes.

### ■ b3-03 Speed Search Deceleration Time

Setting Range: 0.1 to 10.0 Seconds

Factory Default: 2.0 Seconds

Parameter b3-03 sets the deceleration ramp used by the current detection method of Speed Search when searching for the motor's rotor speed. Even if Speed Search 2 is selected, for Speed Search at start, the time entered into b3-03 will be the time to decelerate from maximum frequency (E1-04) to minimum frequency (E1-09).

### ■ b3-05 Speed Search Delay Time

Setting Range: 0.0 to 20.0 Seconds

Factory Default: 0.2 Seconds

In cases where an output contactor is used between the Drive and the motor, extra waiting time is provided after power returns and before Speed Search is performed. This extra time allows for the contactor to operate. When Speed Search at start is used, b3-05 will serve as the lower limit of the Minimum Baseblock Time (L2-03).

### ■ b3-14 Bi-Directional Speed Search Selection

Setting	Description
0	Disabled
1	Enabled ( <i>factory default</i> )

The b3-14 parameter can be used to turn off the bi-directional capabilities of the Speed Estimation form of Speed Search. By turning off the bi-directional capability, the speed search will only try to match the speed in the last known direction.

## ◆ b5 PI Function

The capability to accept an analog signal as feedback for a PI (Proportional + Integral) control function is built into the Drive.

### Speed Command / PI Setpoint

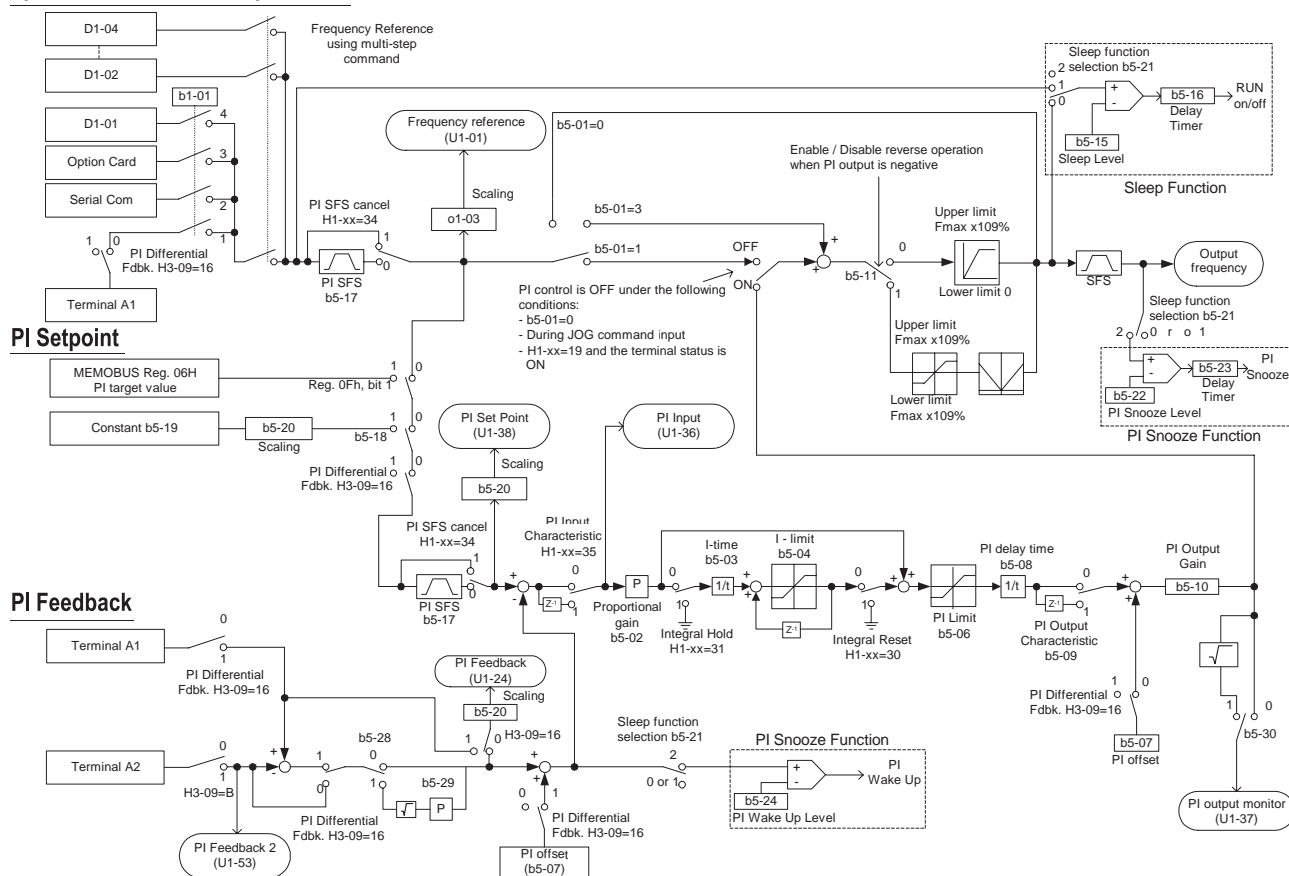

Fig. 15 PI Block Diagram

The analog feedback to the Drive for the PI control is via the A2 terminal. The Drive must be programmed (H3-09= “B: PI Feedback”) to use terminal A2 as feedback for the PI functionality of the Drive.

The PI setpoint can be configured to come from one of many different inputs or parameters. The table below describes the options for originating the PI setpoint.

The PI Setpoint will be read from:	If these conditions are true		
	Status of b5-18	Status of Modbus Register 0Fh bit 1	Status of b1-01
Parameter b5-19	= 1	N/A	N/A
Modbus Register 06H	= 0	ON	N/A
D1-01	= 0	OFF	= 0
Terminal A1	= 0	OFF	= 1
Serial Comm.	= 0	OFF	= 2
Option PCB	= 0	OFF	= 3

In some situations there are two feedback inputs. Air handling unit return fan speed control in a “volume matching” strategy for building pressure control is an example. The drive can be programmed to maintain a set differential between two analog signals. If input A2 is configured as a “PI Differential Mode” (H3-09= “16: PI Differential”), then the Drive will maintain a set difference between the measurements read on inputs A1 and A2. This differential setpoint is programmed by parameter (b5-07).

■ **b5-01 PI Mode**

Setting	Description
0	Disabled ( <i>factory default</i> )
1	Enabled
3	Fref+PI

The Drive can be used as a stand-alone PI controller. If PI functionality is selected by parameter b5-01, the Drive will adjust its output to cause the feedback from a transmitter to match the PI setpoint (b5-19). The setting of b5-01 will determine whether PI functionality is disabled (b5-01= “0: Disabled”), enabled (b5-01= “1: Enabled”), or enable with the output of the PI function used to trim a Speed Command (b5-01= “3: Fref+PI”).

■ **b5-02 Proportional Gain Setting**

Setting Range: 0.00 to 25.00  
 Factory Default: 2.00

The proportional gain will apply a straight multiplier to the calculated difference (error) between the PI Setpoint and the measured transmitter feedback at terminal A2. A large value will tend to reduce the error but may cause instability (oscillations) if too high. A small value may allow to much offset between the setpoint and feedback (See Figure 16 below).

■ **b5-03 Integral Time Setting**

Setting Range: 0.0 to 360.0 Seconds  
 Factory Default: 5.0 Seconds

The Integral factor of PI functionality is a time-based gain that can be used to eliminate the error (difference between the setpoint and feedback at steady state). The smaller the Integral Time set into b5-03, the more aggressive the Integral factor will be. To turn off the Integral Time, set b5-03= 0.00.

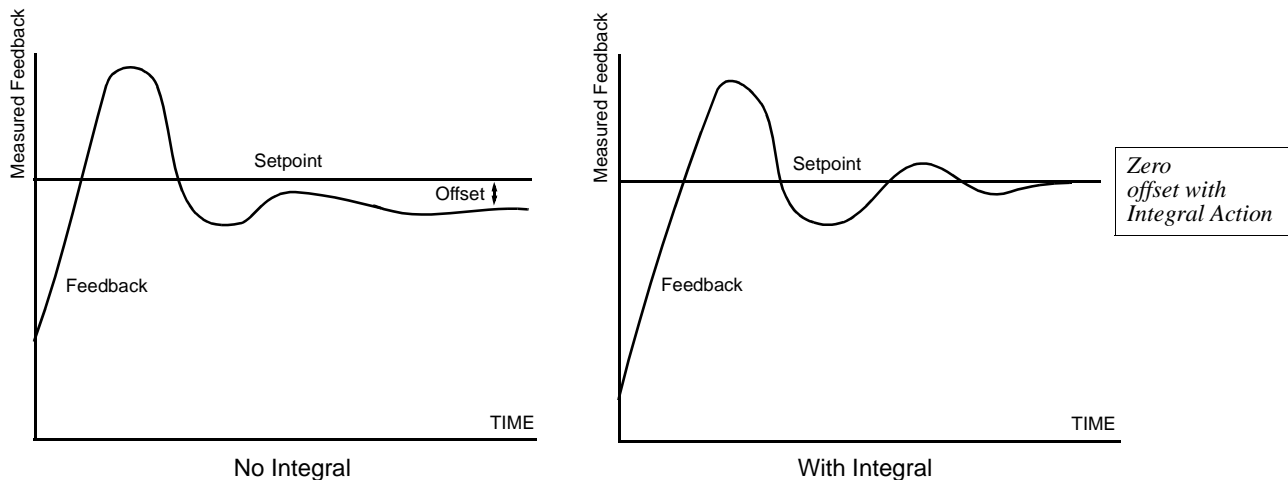

Fig. 16 PID Feedback Response Characteristics

### ■ b5-04 Integral Limit Setting

Setting Range: 0.0 to 100.0%

Factory Default: 100.0%

On some applications, especially those with rapidly varying loads, the output of the PI function may have large oscillations. To suppress these oscillations, a limit can be applied to the integral factor by programming b5-04.

### ■ b5-06 PI Output Limit

Setting Range: 0.0 to 100.0%

Factory Default: 100.0%

Places a cap on the output of the PI function. Limiting the PI function may help to prevent large overshoots in the Drive's response to error (the difference between the setpoint and the feedback).

### ■ b5-07 PI Offset Adjustment

Setting Range: -100.0% to +100.0%

Factory Default: 0.0%

The PI Offset Adjustment parameter has two different uses. Parameter b5-07 serves different functions depending on whether it is used on a standard PI loop or a Differential PI loop.

Parameter b5-07 causes an offset to be applied to the output of the PI function in a non-Differential PI loop. Every time the PI output is updated, the offset (b5-07) is summed with the PI output. This can be used to artificially kick-start a slow starting PI loop.

If the Drive is configured for Differential PI Regulation (H3-09= "16: PI differential"), then this parameter is the target setpoint for the differential to be maintained between the signal measured on analog input A1 and the signal measured on analog input A2.

### ■ b5-08 PI Primary Delay Time Constant

Setting Range: 0.00 to 10.00 Seconds

Factory Default: 0.00 Seconds

Acts as a time based filter that lowers the responsiveness of the PI function, but also makes the function more stable when the setpoint varies rapidly or when the feedback is noisy.

### ■ b5-09 PI Output Level Selection

Setting	Description
0	Normal Output (direct acting) ( <i>factory default</i> )
1	Reverse Output (reverse acting)

Normally, the output of the PI function causes an increase in motor speed whenever the measured feedback is below the setpoint. This is referred to as direct acting response. However, if b5-09= "1: Reverse Output", the output of the PI function causes the motor to slow down when the feedback is below the setpoint. This is referred to as reverse acting response.

### ■ b5-10 PI Output Gain Setting

Setting Range: 0.0 to 25.0  
 Factory Default: 1.0

Applies a multiplier to the output of the PI function. Using the gain can be helpful when the PI function is used to trim the Speed Command. Increasing b5-10 causes the PI function to have a greater regulating affect on the speed command.

### ■ b5-11 PI Reverse Selection

Setting	Description
0	0 Limit ( <i>factory default</i> )
1	Reverse

Parameter b5-11 determines whether reverse operation is allowed while using PI control (b5-01≠0). The factory default setting will not allow the Drive to run in reverse. This parameter does not need to be changed from factory default for a majority of HVAC applications. (Refer also to b5-09).

### ■ b5-12 PI Feedback Reference Missing Detection Selection

Setting	Description
0	Disabled ( <i>factory default</i> )
1	Alarm
2	Fault

Loss of feedback can cause problems to a PI application. The Drive can be programmed to turn on a digital output whenever a loss of feedback occurs. Feedback Loss Detection is turned on by b5-12. When b5-12= “1: Alarm”, the Drive acknowledges the loss of feedback without stopping or turning on the fault output (MA-MB). If b5-12= “2: Fault”, the Drive coasts to a stop and turns on the fault output if the feedback is determined to be lost.

### ■ b5-13 PI Feedback Loss Detection Level

Setting Range: 0 to 100%  
 Factory Default: 0%

### ■ b5-14 PI Feedback Loss Detection Time

Setting Range: 0.0 to 25.0 Seconds  
 Factory Default: 1.0 Seconds

The Drive interprets feedback loss whenever the feedback signal drops below the value of b5-13 and stays below that level for at least the time set into b5-14. See Figure below for timing details.

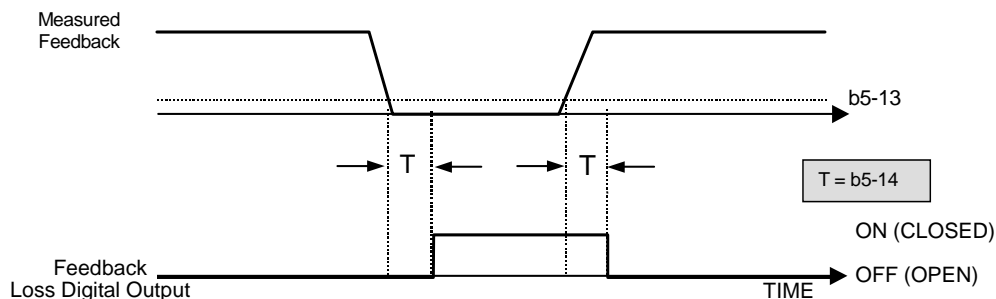

Fig. 17 Loss of PI Feedback Feature

■ **b5-15 Sleep Function Start Level**

Setting Range: 0.0 to 200.0 Hz  
 Factory Default: 0.0 Hz

■ **b5-16 Sleep Delay Time**

Setting Range: 0.0 to 25.5 Seconds  
 Factory Default: 0.0 Seconds

The Sleep Function can be programmed to prevent running the Drive when the PI loop output or the speed command is so low that no usable work is being done and/or equipment damage may result. The Sleep Function can be Enabled by entering a value in parameter b5-15. If the Drive’s output drops below the level set by the Sleep Function Start Level (b5-15) and remains there at least as long as the delay time determined by the Sleep Delay Time (b5-16), then the Drive’s internal Run command drops out and the Drive output ceases. Though the Drive’s output has ceased, all other Drive functions continue. Once the Drive’s theoretical output returns to a level above the Sleep Function Start Level (b5-15) and remains above that level for at least the Sleep Delay Time (b5-16), the internal Run command returns and the Drive output begins again. The b5-16 Delay Time prevents oscillation about the sleep level.

**Note:** The sleep function can be used even if the PI function is disabled (b5-01 = “0: Disabled”).

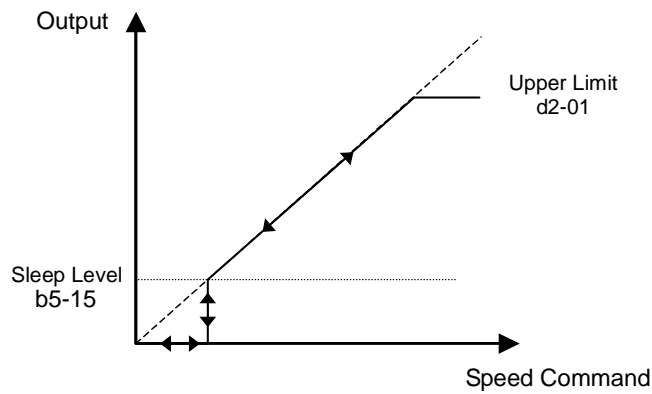

Fig. 18 Sleep Function Response

■ **b5-17 PI Accel/Decel Time**

Setting Range: 0.0 to 25.5 Seconds  
 Factory Default: 0.0 Seconds

This is a soft start function that is applied to the PI setpoint analog input. Instead of having nearly instantaneous changes in signal levels, there is a programmed ramp applied to level changes. When changing setpoints the error can be limited by gradually ramping the setpoint through the use of parameter b5-17.

■ **b5-18 PI Setpoint Selection**

Setting	Description
0	Disabled ( <i>factory default</i> )
1	Enabled

In order to use parameter b5-19 as the PI Setpoint, set parameter b5-18= “1: Enabled”. If b5-18= “0: Disabled” the PI Setpoint will either be:

- Modbus Register 06H (If Register 0FH bit 1 is high)
- The active speed command (i.e. Determined by the setting of b1-01). See Table 1 “Setpoint Options”

### ■ b5-19 PI Setpoint Value

Setting Range: 0.00 to 100.00%

Factory Default: 0.00%

Parameter b5-19 is for a PI Setpoint value. When b5-18= “1: Enabled”, the value of b5-19 will take precedent over any other PI setpoint unless the Drive is set up for Differential Feedback, in which case, b5-18 and b5-19 have no affect on the PI function.

### ■ b5-20 PI Setpoint Display Scaling

Setting	Description
0	Hz ( <i>factory default</i> )
1	%
3	RPM (Synchronous)
3	Engineering Units

The PI Setpoint Display Scaling value (b5-20) is a scaling factor that is applied to the monitor display for both the PI Setpoint (U1-38) and the PI Feedback (U1-24).

If b5-20 is:	U1-24 and U1-38 Display Increments.
0	0.01 Hz
1	0.00%
2 through 39 (enter the # of motor poles)	0RPM
40 through 39999	Engineering Units

If the monitors seem more natural in terms of percentage, set b5-20= 1. If the monitors are easier to work with when displaying the equivalent synchronous RPM, set b5-20= [the number of motor poles].

If another engineered unit, such a fpm or cfm, is desired, set b5-20= xxxxx where

  X     X     X     X     X    
 Digit 5 Digit 4 Digit 3 Digit 2 Digit 1

Digits 1 through 4 set the desired number to be displayed at 100% speed.

Digit 5 determines the number of decimal places

- If Digit 5 = 0 number format is XXXX
- If Digit 5 = 1 number format is XXX.X
- If Digit 5 = 2 number format is XX.XX
- If Digit 5 = 3 number format is X.XXX

For example:

If b5-20= 10425 then at 100% output the digital operator would display 42.5 for monitor U1-38 or U1-24.

## ■ b5-21 Sleep Source

Setting	Description
0	SFS Input (Output of PI block)
1	PI Setpoint ( <i>factory default</i> )
2	Snooze

Parameter b5-21 selects the sleep function characteristic action:

When b5-21= “0: SFS Input” the sleep function start level (b5-15) is compared to the Drive’s output (Speed Command after PI block). This is the setting that should be used for open loop or closed loop control.

It is also possible to have the sleep function start level (b5-15) compared to the Drive input or setpoint. For this special application set b5-21= “1: PI Setpoint”.

When b5-21= “2: Snooze” a variation of the sleep function called “Snooze” is enabled, see parameter b5-22 to b5-27.

**IMPORTANT** | The sleep function can be used even if the PI function is disabled (b5-01= “0: Disabled”).

## ■ b5-22 PI Snooze Level

Setting Range: 0 to 100%

Factory Default: 0%

## ■ b5-23 PI Snooze Delay Time

Setting Range: 0 to 3600 Seconds

Factory Default: 0 Seconds

## ■ b5-24 PI Snooze Deactivation Level

Setting Range: 0 to 100%

Factory Default: 0%

The Snooze Function is a variation on the Sleep Function. The Snooze function must be selected by setting parameter b5-21= “2: Snooze”. Once the Snooze Function is selected, the Drive monitors the output frequency. If the output frequency drops below the PI Snooze Level (b5-22), and stays below that level for at least the PI Snooze Delay Time (b5-23), the Drive output shuts off. This is different from the Sleep Function because it is the feedback that must drop below the PI Snooze Deactivation Level (b5-24) before normal Drive output will begin again. See Figure 19 below.

## ■ b5-25 PI Setpoint Boost Setting

Setting Range: 0 to 100%

Factory Default: 0%

Just before the Snooze Function is activated, the PI Setpoint can be temporarily increased to create an overshoot of the intended PI Setpoint. The temporary boost is determined by the PI Setpoint Boost Setting (b5-25). Once the temporary boost level is reached (or the PI Maximum Boost Time (b5-26) is exceeded), the Drive output shuts off (snoozes) and the intended PI Setpoint returns. From this point on, the Snooze Function operates normally and the Drive output returns when the feedback level drops below b5-24. See Figure 20 below.

### ■ b5-26 PI Maximum Boost Time

Setting Range: 0 to 3600 Seconds

Factory Default: 0 Seconds

Associated with the Snooze Function. In cases where the temporary PI Setpoint (intended PI setpoint + PI Setpoint Boost) cannot be reached within the PI Maximum Boost Time (b5-26), the Setpoint Boost is interrupted and the Drive output is turned off.

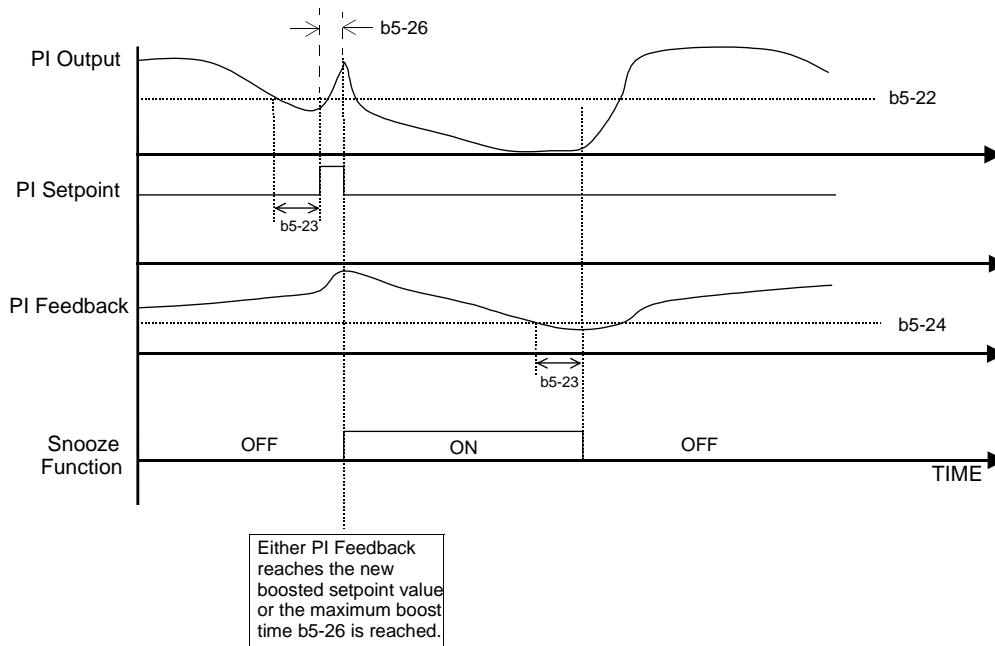

Fig. 19 Snooze Function Operation

### ■ b5-27 PI Snooze Feedback Level

Setting Range: 0 to 100%

Factory Default: 60%

This is a second method of initiating the Snooze Function. If the PI feedback level exceeds the PI Snooze Feedback Level (b5-27), then the Drive output shuts off. Once the PI feedback drops below the PI Snooze Deactivation Level (b5-24) then normal Drive and PI operation return.

### ■ b5-28 PI Feedback Square Root Function Activation

Setting	Description
0	Disabled ( <i>factory default</i> )
1	Enabled

If b5-28= “1: Enabled”, the square root of the PI feedback is compared to the PI Setpoint in order to determine appropriate Drive output to properly regulate the system. This is helpful in cases where the measured feedback is pressure but the PI loop needs to regulate flow.

### ■ b5-29 PI Square Root Gain

Setting Range: 0.00 to 2.00

Factory Default: 1.00

A multiplier applied to the square root of the feedback.

### ■ b5-30 PI Output Square Root Monitor Selection

Setting	Description
0	Disabled ( <i>factory default</i> )
1	Enabled

If the PI Function is regulating the flow of a closed loop system by using a pressure feedback, it may be convenient to view the square root of the PI output using monitor U1-37.

---

## ◆ b8 Energy Savings

The energy savings function improves overall system operating efficiency by operating the motor at its highest efficiency. This is accomplished by continuously monitoring the motor load and adjusting the motor terminal voltage so that the motor always operates near its rated slip frequency. A motor is most efficient when operating near rated slip conditions.

### ■ b8-01 Energy Savings Selection

Setting	Description
0	Disabled ( <i>factory default</i> )
1	Enabled

When the Energy Savings function is enabled (b8-01= “1: Enabled”), the Drive reduces the output voltage to the motor below the voltage value specified by the programmed V/f pattern whenever the motor load is light. Since torque is reduced during this voltage reduction, the voltage has to return to normal levels when the load returns. The energy savings is realized through improved motor efficiency. The reduced output voltage causes increased rotor slipping even with a light load. A motor is most efficient when operating fully loaded (i.e. operating at rated slip).

### ■ b8-04 Energy Saving Coefficient Value

Setting Range: 0.0 to 655.0

Factory Default: Model Dependent

Parameter b8-04 is used in maximizing motor efficiency. The factory setting will be Drive capacity dependant but can be adjusted in small amounts while viewing the kW monitor (U1-08) and running the Drive to minimize the output kW. A larger value typically results in less voltage to the motor and less energy consumption. Too large a value will cause the motor to stall.

### ■ b8-05 Power Detection Filter Time

Setting Range: 0 to 2000 mS

Factory Default: 20 mS

The Energy Saving function will search out the lowest output voltage in order to achieve minimum output power usage. Parameter b8-05 determines how often the output power (kW) is measured and the output voltage is adjusted.

### ■ b8-06 Search Operation Voltage Limit

Setting Range: 0 to 100 %

Factory Default: 0%

Once Energy Savings is enabled and the optimal energy saving coefficient value has been set, the programmer can have the Drive further search out the proper voltage to achieve the lowest output power by making minute changes to the output voltage and measuring the output power every b8-05 ms. Parameter b8-06 sets limits to the range over which the voltage will be adjusted in order to minimize the power output. Settings too large a value may allow the motor to stall if the load is applied abruptly.

If b8-06= 0, then the optimum voltage search operation is disabled (but not Energy Savings itself).

---

## ◆ C1 Accel/Decel

### ■ C1-01 Acceleration Time 1

#### C1-02 Deceleration Time 1

#### C1-03 Acceleration Time 2

#### C1-04 Deceleration Time 2

Setting Range: 0.0 to 6000.0 Seconds

Factory Default: 30.0 Seconds

C1-01 (Acceleration Time 1) sets the time to accelerate from zero to maximum speed (E1-04). C1-02 (Deceleration Time 1) sets the time to decelerate from maximum speed to zero. C1-01 and C1-02 are the factory default active accel/decel “pair”. Another accel/decel pair (C1-03 and C1-04) exists that can be activated by a multi-function digital input (H1-0x= 7), or specified by a switch over frequency as programmed in parameter C1-11.

**Note:** If fan applications employing duct high pressure safety limit switches, it may be necessary to further adjust the deceleration time to avoid high pressure limit trips due to damper closure as the system is shut down. (An alternate solution in this situation is to set parameter b1-03 to “Coast to Stop”).

### ■ C1-09 Fast Stop Time

Setting Range: 0.0 to 6000.0 Seconds

Factory Default: 10.0 Seconds

A special deceleration parameter is available for use with emergency or fault operations. Parameter C1-09 will set a special deceleration that can be operated by closing a digital input configured as H1-0x= 15 or H1-0x= 17. A digital input configured as H1-0x= 15 will look for a switch closure before initiating the Fast Stop operation. A digital input configured as H1-0x= 17 will look for the switch opening before initiating the Fast Stop operation.

Unlike a standard deceleration time, once the Fast Stop operation is initiated even momentarily, the Drive cannot be re-operated until the deceleration is complete, the Fast Stop input is cleared, and the Run command is cycled.

## ◆ d2 Reference (Speed Command) Limits

### ■ d2-01 Frequency Reference Upper Limit

Setting Range: 0.0 to 110.0%

Factory Default: 100.0%

### ■ d2-02 Frequency Reference Lower Limit

Setting Range: 0.0 to 110.0%

Factory Default: 0.0%

The use of parameters d2-01 and d2-02 places limitations on the speed command that the Drive will accept. The parameters are set in units of percentage of the maximum frequency (E1-04) and provide limits on any remote speed command input. By entering upper or lower frequency limits, the Drive programmer can prevent operation of the Drive above or below levels that may cause resonance, equipment damage or discomfort (see also parameter d3-0X). For example, limits may be needed to prevent low speed operation of: Cooling tower fans with gear boxes, pumps with pressure dependent seals, or AHUs with minimum delivery requirements.

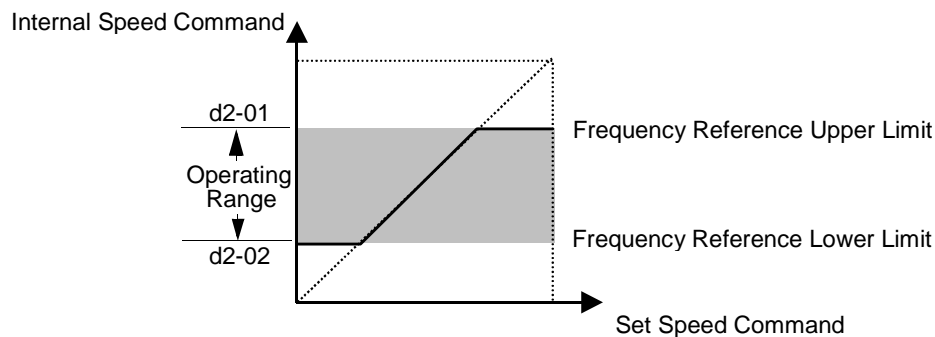

Note: See also the “Sleep” function in Figure 19 for alternate “lower limit” implementation.

Fig. 20 Frequency Reference Upper and Lower Limit Effects on the Speed Command

### ■ d2-03 Master Speed Reference Lower Limit

Setting Range: 0.0 to 110.0%

Factory Default: 0.0%

Unlike Frequency Reference Lower Limit (d2-02) which will affect the speed command no matter where it is sourced from (i.e. analog input, preset speed, jog speed, etc.), the Master Speed Reference Lower Limit (d2-03) sets a low speed threshold that will only affect the analog input that is the active master speed frequency (as determined by parameter H3-13 and H3-09). This parameter allows a minimum speed to be programmed for the master reference while allowing a lower speed to be set as a jog reference. If the speed commanded by the active master speed frequency is below the setting of d2-03, then the Drive will operate at the speed specified by d2-03.

## ◆ d3 Jump Frequencies

- d3-01 Jump Frequency 1
- d3-02 Jump Frequency 2
- d3-03 Jump Frequency 3

Setting Range: 0.0 to 200.0 Hz  
Factory Default: 0.0 Hz

### ■ d3-04 Jump Frequency Width

Setting Range: 0.0 to 20.0 Hz  
Factory Default: 1.0 Hz

In order to avoid continuous operation at a speed that causes resonance in driven machinery, the Drive can be programmed with jump frequencies that will not allow continued operation within specific frequency ranges. If a speed is commanded that falls within a dead band, or Jump Frequency, the Drive will clamp the frequency reference just below the dead band and only accelerate past it when the commanded speed rises above the upper end of the dead band, for increasing references. Similarly, the Drive will clamp the frequency reference just above the dead band and only decelerate past it when the command speed falls below the lower end of the dead band, for decreasing references.

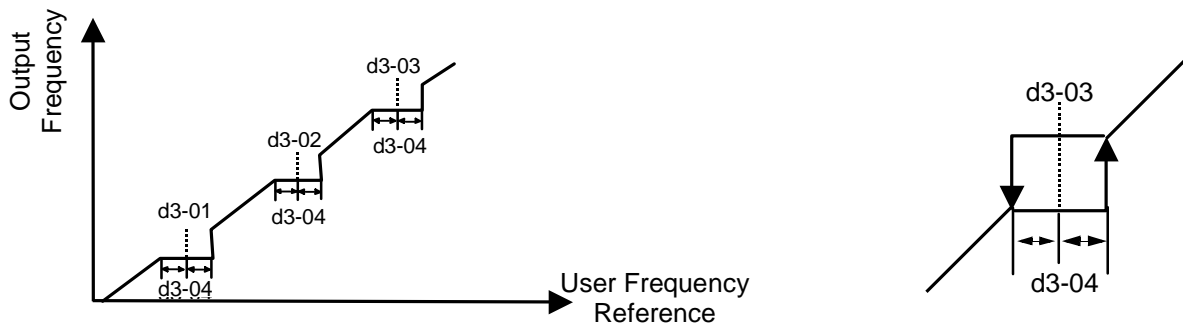

Fig. 21 Jump Frequency Characteristics

Setting the center point of the dead band with the d3-01 through d3-03 parameters and setting the width of the dead band with parameter d3-04 determines the dead band characteristics. The programmer can set up to three Jump Frequencies. If multiple Jump Frequencies are programmed the following rule applies:

$$d3-01 \leq d3-02 \leq d3-03$$

---

## ◆ E1 V/f Pattern

### ■ E1-01 Input Voltage Setting

Setting Range: 155.0V to 255.0V (208V/240V Models)  
310.0V to 510.0V (480V Models)

Factory Defaults: 208.0V (208V Models)  
240.0V (240V Models)  
480.0V (480V Models)

Set the Input Voltage parameter (E1-01) to the nominal voltage of the connected AC power supply. This parameter adjusts the levels of some protective features of the Drive (i.e. Overvoltage, Stall Prevention, etc.). E1-01 also serves as the Maximum/Base Voltage used by the Preset V/Hz curves (E1-03= 0 to D).

### ■ E1-03 V/f Pattern Selection

Setting	Description
0	50 Hz
1	60 Hz Saturation
2	50 Hz Saturation
3	72 Hz
4	50 Hz VT1
5	50 Hz VT2
6	60 Hz VT1
7	60 Hz VT2
8	50 Hz HST1
9	50 Hz HST2
A	60 Hz HST1
B	60 Hz HST2
C	90 Hz
D	120 Hz
F	Custom V/f ( <i>factory default, with parameter values per setting 1</i> )
FF	Custom w/o limit

The Drive operates utilizing a set V/f pattern to determine the appropriate output voltage level for each commanded speed. There are 14 different preset V/f patterns to select from with varying voltage profiles, saturation levels (frequency at which maximum voltage is reached), and maximum frequencies.

There are also settings for Custom V/f patterns that will allow the programmer to manually set (“Customize”) the V/f pattern using parameters E1-04 through E1-13.

Using parameter E1-03, the programmer can select one of the preset V/f patterns or chose between a custom V/F pattern with an upper voltage limit (E1-03= “F: Custom V/F”) and a custom V/f pattern without a voltage limit (E1-03= “FF: Custom w/o limit”).

Table 3 Preset V/f Patterns											
	Specifications		E1-03	V/f Pattern *1		Specifications		E1-03	V/f Pattern *1		
General-purpose	50Hz		0		High Starting Torque *2	50Hz		8			
						High Starting Torque 2		9			
	60Hz Saturation		1			60Hz		High Starting Torque 1		A	
	50Hz Saturation		2			High Starting Torque 2		B			
72Hz		3		90Hz		C					
Variable Torque	50Hz		4		High Speed Operation	120Hz		D			
	Variable Torque 1		5								
	Variable Torque 2		5								
	60Hz		6								
Variable Torque 1		6									
Variable Torque 2		7									

If one of the custom V/f patterns is selected, then parameters E1-04 through E1-13 will determine the V/F pattern.

Table 3 is for 240V class units only; for 480V class unit multiply the voltage value by 2.

**IMPORTANT**

When a factory Initialization is performed, the setting of E1-03 is unaffected but the settings of E1-04 through E1-13 are returned to their factory default settings.

■ **E1-04 Maximum Output Frequency**

Setting Range: 0.0 to 120.0 Hz

Factory Default: 60.0 Hz

### ■ E1-05 Maximum Output Voltage

Setting Range: 0.0 to 255.0V (240V Models)  
0.0 to 510.0V (480V Models)

Factory Defaults: 240.0V (240V Models)  
480.0V (480V Models)

### ■ E1-06 Base Frequency

Setting Range: 0.0 to 200.0 Hz (settings above 120.0 Hz are currently not supported)  
Factory Default: 60.0 Hz

### ■ E1-07 Mid Output Frequency A

Setting Range: 0.0 to 200.0 Hz (settings above 120.0 Hz are currently not supported)  
Factory Default: 3.0 Hz

### ■ E1-08 Mid Output Voltage A

Setting Range: 0.0 to 255.0V (240V Models)  
0.0 to 510.0V (480V Models)

Factory Defaults: 18.0V (240V Models)  
33.6V (480V Models)

### ■ E1-09 Minimum Output Frequency

Setting Range: 0.0 to 200.0 Hz (settings above 120.0 Hz are currently not supported)  
Factory Default: 1.5 Hz

### ■ E1-10 Mid Output Voltage

Setting Range: 0.0 to 255.0V (240V Models)  
0.0 to 510.0V (480V Models)

Factory Defaults: 10.8V (240V Models)  
16.8V (480V Models)

### ■ E1-11 Mid Output Frequency B

Setting Range: 0.0 to 200.0 Hz (settings above 120.0 Hz are currently not supported)  
Factory Default: 0.0 Hz

### ■ E1-12 Mid Output Voltage B

#### E1-13 Base Voltage

Setting Range: 0.0 to 255.0V (240V Models)  
0.0 to 510.0V (480V Models)

Factory Defaults: 0.0V (240V Models)  
0.0V (480V Models)

To set up a custom V/f pattern, program the points shown in the diagram below using parameters E1-04 through E1-13. Be sure that the following condition is true:

$$E1-09 \leq E1-07 \leq E1-06 \leq E1-11 \leq E1-04$$

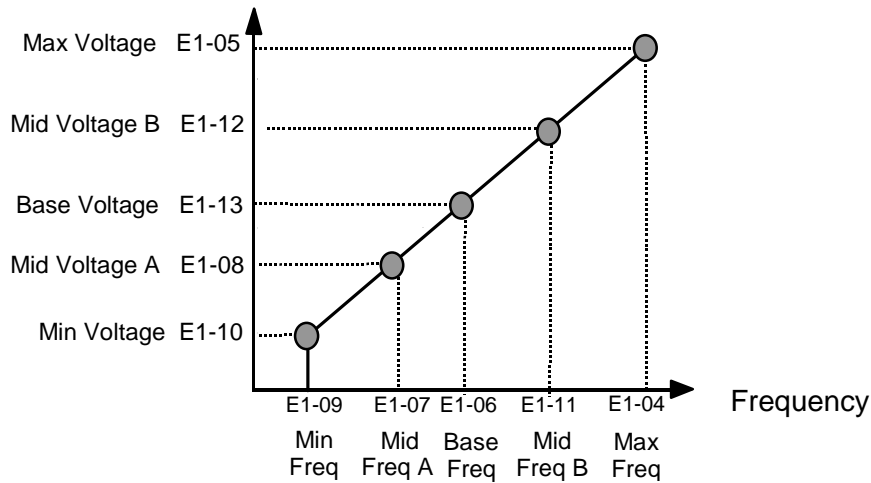

Fig. 22 Custom V/f Pattern Programming Curve

Increasing the voltage in the V/f pattern increases the available motor torque. However, when setting a custom V/f pattern, increase the voltage gradually while monitoring the motor current, to prevent:

- Drive faults as a result of motor over-excitation
- Motor overheating or excessive vibration

## ◆ E2 Motor Setup

### ■ E2-01 Motor Rated Current

Setting Range: Model Dependent (see Appendix B)  
 Factory Default: Model Dependent

The Motor Rated Current parameter (E2-01) is necessary information for the Drive motor protection function. The motor overload protection parameter L1-01 is enabled by default. In addition, motor rated current is used by the torque compensation function to insure optimum torque production. Set E2-01 to the full load amps (FLA) value stamped on the motor's nameplate. During Auto-tuning, it is required for the operator to enter the motor rated current in parameter T1-04 on the Auto-Tuning menu. If the Auto-tuning operation completes successfully, the value entered into T1-04 will be also written into E2-01.

For applications employing a Drive that is oversized for the motor, E2-01 may be set as low as 10% of the Drive output current rating. The AMP value in E2-01, however, must always be greater than the "No Load Current" value in parameter E2-03 or an OPE02 error will be displayed.

### ■ E2-03 No Load Current

Setting Range: Model Dependent (see Appendix B)

Factory Default: Model Dependent

Set E2-03 to the motor no-load current at rated voltage and rated frequency. Consult the motor manufacturer for the proper value if the no load current is not stated on the motor nameplate.

---

## ◆ F6 Com OPT Setup (applies only to the LonWorks option)

### ■ F6-01 Operation Selection After Communication Error

Setting	Description
0	Ramp to Stop
1	Coast to Stop ( <i>factory default</i> )
2	Fast-Stop
3	Alarm Only

If a serial communication option board is attached to the Drive at the 2CN connector, the Drive will automatically monitor the card for any type of communication errors. F6-01 is applicable no matter whether a run command or speed command is coming via the option board, digital operator, or terminal input. The setting of F6-01 determines whether the communication error is seen as a fault or an alarm. If F6-01= “3: Alarm Only”, then the fault output is not energized upon a communication error. All other settings of F6-01 cause the fault output to energize. The setting of F6-01 does not apply to any of the embedded communication protocols used at the RS-485/422 terminals on the removable terminal board. (See parameters H5-0X).

### ■ F6-02 Option PCB External Fault Detection Selection

Setting	Description
0	Always Detected ( <i>factory default</i> )
1	Detected only during operation

### ■ F6-03 Option PCB External Fault Stopping Method

Setting	Description
0	Ramp to Stop
1	Coast to Stop ( <i>factory default</i> )
2	Fast-Stop
3	Alarm Only

If an external fault is received from the LONWORKS® or other communication option card, the settings of F6-02 and F6-03 will determine the Drive operation in reaction to the fault signal. Parameter F6-02 will determine if the external fault is always recognized (F6-02= “0: Always Detected”) or only recognized when the Run command is active (F6-02= “1: Detected only during operation”).

Once the fault is recognized, parameter F6-03 will determine the operation of the Drive. If parameter F6-03 is set to anything other than “3”, the Drive will fault and a stopping sequence is begun. If F6-03= “3: Alarm Only”, then the external fault is treated like an alarm. Operation will continue and an EF0 fault will flash on the digital operator.

## ■ F6-05 Current Scaling via Communication Option PCB

Setting	Description
0	A Display ( <i>factory default</i> )
1	100%/8192 (Drive Rated Current)

A communication option card can read the Drive's DPRAM to access the current monitor. The format of the current reading in the DPRAM will be determined by parameter F6-05.

F6-05= "0: A Display" → Current is a decimal number corresponding to actual Amperes

F6-05= "1: 100%/8192 (Drive Rated Current)" → Current reading is a number where  
8192 = 100% of Drive rated output current

## ◆ H3 Analog Inputs

### ■ H3-02 Terminal A1 Gain Setting

Setting Range: 0.0 to 1000.0%

Factory Default: 100.0%

### ■ H3-03 Terminal A1 Bias Setting

Setting Range: -100.0% to +100.0%

Factory Default: 0.0%

In order to have the Drive properly interpret an analog input, it may be necessary to apply a gain and/or a bias to the signal. The analog inputs have a resolution of 10 bits (1024 steps). Using the factory default settings for the analog input's gain and bias, the 0-10Vdc or 4-20mA signal at the analog input will yield a 0-100% speed command span.

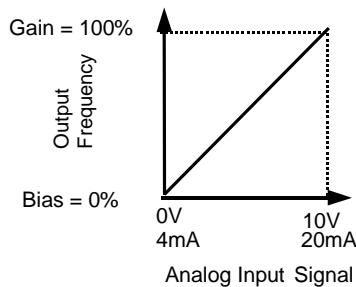

Fig. 23 Output Frequency as Commanded Via Analog Input

If a different span of analog input signal is desirable, it will be necessary to adjust the gain, the bias, or both to allow the analog input level to generate the desired frequency command. Adjustment of the gain setting will change the speed command that is equivalent to the maximum analog input (10Vdc or 20mA). If, for instance, the gain is increased to 200%, then 10Vdc or 20mA will be equivalent to a 200% speed command and 5 VAC or 12mA will be equivalent to a 100% Speed Command. Since the Drive output is limited by the maximum frequency parameter (E1-04), 0-5Vdc or 4-12mA will now be equivalent to 0-100% speed command span.

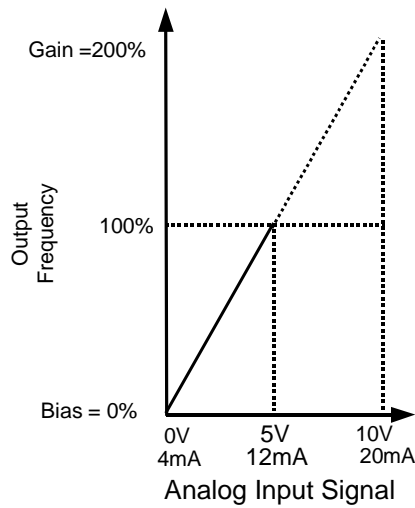

Fig. 24 Output Frequency as Commanded via Analog Input with Increased Gain Setting

Adjustment of the bias setting will likewise adjust the speed command that is equivalent to the minimum analog input level (0Vdc or 4mA). If, for instance, the bias is set to  $-25\%$ , then 0Vdc or 4mA will be equivalent to a  $-25\%$  speed command. Since the minimum speed command is 0% an analog input of 2.5 to 10Vdc or 8 to 20mA will now be equivalent to 0-100% speed command span.

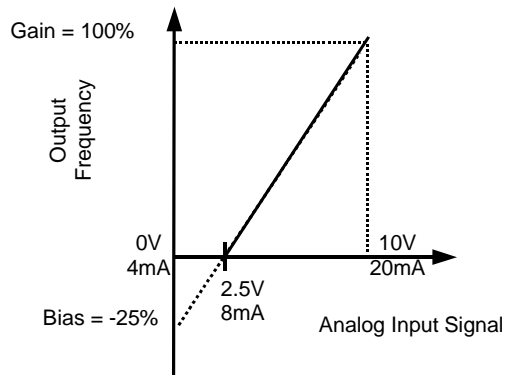

Fig. 25 Output Frequency with Reduced Bias Setting

As a further example, for an inverse-acting speed command, set the bias= 100% and the gain= 0%. The minimum analog input level (0Vdc or 4mA) will produce a 100% speed command and the maximum analog input level (10Vdc or 20mA) will produce a 0% speed command.

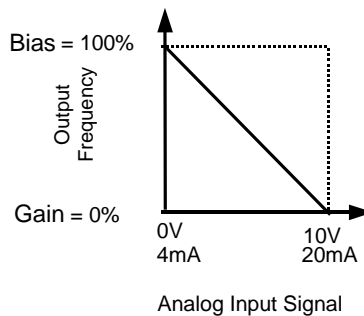

Fig. 26 Output Frequency with Inverted Gain and Bias Settings

■ H3-08 Terminal A2 Signal Level

Setting	Description
0	0 - 10VDC
2	4 - 20mA (Default)

The H3-08 parameter (Terminal A2 Signal Level) allows the programmer to specify the signal that will be applied to the A2 analog input. The A2 analog input can accept either a 0–10 Vdc or 4-20 mA signal as a reference. The Drive also has a DIP switch (S1) on the removable terminal board that must be set for the proper reference signal into the A2 analog input. The S1-2 dipswitch setting determines the internal resistance of the A2 input while parameter H3-08 determines how the Drive interprets the measured signal.

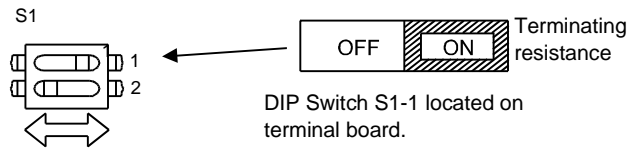
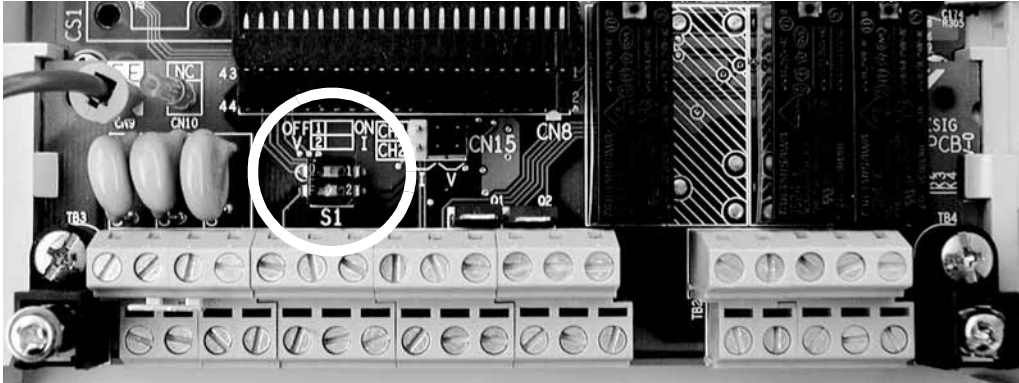

Fig. 27 DIP Switch S1

Name	Function	Setting
S1-1	RS-485 and RS-422 terminating resistance	OFF: No terminating resistance ON: Terminating resistance of 110 Ω
S1-2	Input signal for analog input A2	OFF: 0 to 10 V (internal resistance: 20 kΩ) ON: 4 to 20 mA (internal resistance: 250 Ω) (Default)

## ■ H3-09 Terminal A2 Function Selection

Setting	Description
0	Frequency Bias
2	Aux Reference ( <i>factory default</i> )
B	PI Feedback
D	Frequency Bias 2
E	Motor Temperature
16	PI Differential
1F	Not Used

The A2 analog input can be programmed to perform many different functions. The setting of parameter H3-09 determines which of the following functions the A2 analog input will perform.

### Function: Frequency Bias

#### Setting: 0

By setting H3-09= “0: Frequency Bias”, the A2 analog input will serve as a bias signal to the A1 Speed Command. The effect of using A2 for a frequency bias is that the level of the A2 analog input will be summed with the level of the Speed Command analog input (A1). For example, if H3-02= 100%, H3-03= 0%, and the A2 analog input level is 1 Vdc, the Speed Command profile will look like the figure below. If A1= 0 Vdc the Speed Command would be 10% of the programmed maximum frequency because  $A1 (0 \text{ Vdc}) + A2 (1 \text{ Vdc}) = 1 \text{ Vdc}$ .

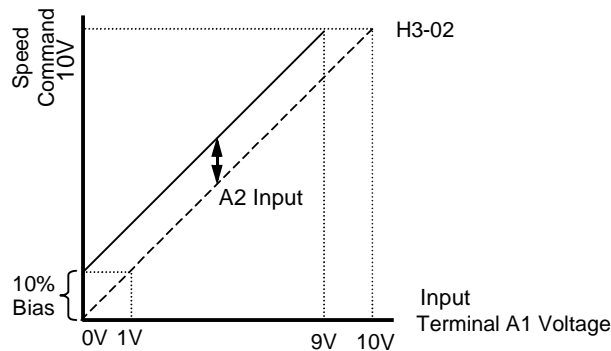

Fig. 28 Effect of Frequency Bias Function on Speed Command

It should be noted that the bias applied by the A2 analog input functions differently than the level set by the H3-03. If both biases are used simultaneously they will sum together.

The level of the A1 analog input, as a percentage of the maximum input (either 10 Vdc or 20 mA), can be viewed by the U1-15 monitor. The level of the A2 analog input, as a percentage of the maximum input, can be viewed by the U1-16 monitor.

The bias applied by setting H3-09= “0: Frequency Bias”, can be used in conjunction with the parameter bias H3-03. In that case the H3-03 bias is applied first which changes the slope of the Speed Command vs. Terminal A1 Voltage graph. Then the level of the A2 analog input is summed with the A1 analog input level, which in effect shifts the Speed Command vs. Terminal A1 Voltage graph upwards or downwards but does not change the slope of the line.

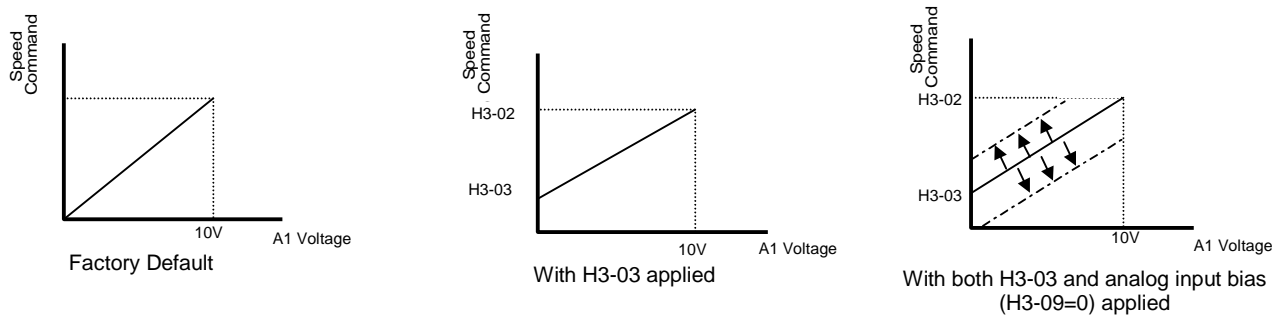

Fig. 29 Frequency Bias Applied to Analog Speed Command

**Function: Aux Reference**

**Setting: 2**

In order for the A2 analog input to be used as the master Speed Command, parameter H3-09 must be set for Aux Reference (H3-09= “2: Aux Reference”). Once A2 is configured as an auxiliary reference, it can be selected as the master Speed Command by setting H3-13= “1: Main Fref TA2”. If H3-09= 2, terminal A2 analog input will become the speed command when a digital input programmed for Multi-Step Ref 1 (H1-0x= 3) is selected by a contact closure.

**Function: PI Feedback**

**Setting: B**

Configuring the A2 analog input as PI Feedback (H3-09= “B: PI Feedback”) is a requirement of setting the Drive up for PI operation. The A2 analog input is the only source for feedback for PI operation though the setpoint can come from a number of different sources (refer to the section covering the PI parameters for more information regarding specifying the setpoint source. PI parameters are listed in section b5).

Parameters H3-10 (Terminal A2 Gain) and H3-11 (Terminal A2 Bias) can be used to configure the A2 analog input to match the signal from the Feedback Transmitter.

The U1-24 monitor (PI Feedback) can be used to check the PI Feedback level with the digital operator.

**Function: Frequency Bias 2**

**Setting: D**

By setting H3-09= “D: Frequency Bias 2”, the A2 analog input will serve as a bias signal to the A1 Speed Command. This setting functions the same as a setting of H3-09=0: Frequency Bias.

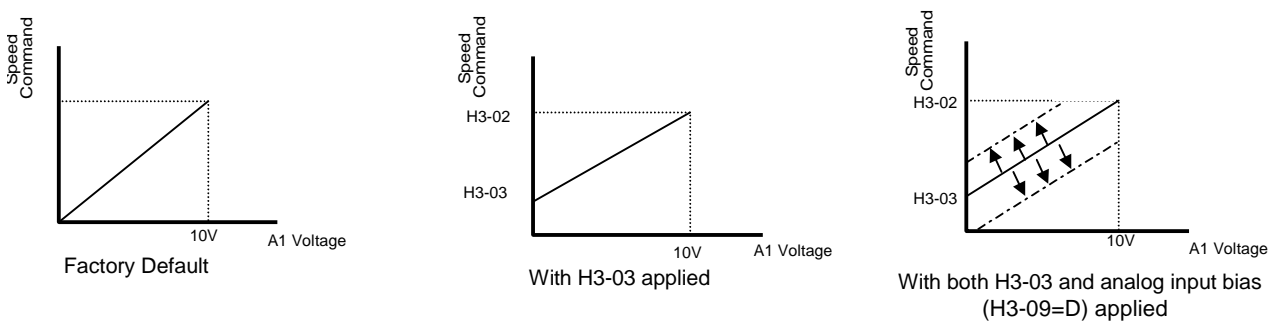

Fig. 30 Frequency Bias 2 Applied to Analog Speed Command

**Function: PI Differential**

**Setting: 16**

Normal PI operation will adjust the Drive output in order to match the measured feedback value to a desired setpoint. When PI is operated in the differential mode, however, the Drive output is adjusted in order to maintain a desired differential between two feedback signals.

When the A2 analog input is configured as a PI Differential (H3-09= “16: PI Differential”), the A1 analog input becomes the other PI Differential input. The desired differential is set by parameter b5-07 (PI Differential Setpoint) and can be set so that A2 is held less than A1 (b5-07 <0) or A2 is held greater than A1 (b5-07>0).

When PI Differential operation is chosen, the A1 feedback level can be monitored by U1-24 (PI Feedback) and the A2 feedback level can be monitored by U1-53 (PI Feedback2).

**Function: Not Used**

**Setting: 1F**

When H3-09= “1F: Not Used”, any signal applied to the A2 analog input will be ignored by the Drive.

■ **H3-10 Terminal A2 Gain Setting**

Setting Range: 0.0 to 1000.0%

Factory Default: 100.0%

■ **H3-11 Terminal A2 Bias Setting**

Setting Range: -100.0% to +100.0%

Factory Default: 0.0%

Parameters H3-10 and H3-11 perform the same function for the A2 analog input that parameters H3-02 and H3-03 perform for the A1 analog input. Please refer to the parameter description for H3-02 and H3-03 for information about H3-10 and H3-11.

These parameters could be used for final calibration of a factory or field installed pressure to electric transducer input connected to terminal A2 and AC. This field calibration may be needed if there is a job site variation from the typical 3 to 15 PSIG pneumatic signal input range.

■ **H3-12 Analog Input Filter Time Constant**

Setting Range: 0.0 to 2.00 Seconds

Factory Default: 0.30 Seconds

An analog input filter can be used to prevent erratic Drive control when a “noisy” analog reference is used. Parameter H3-12 sets the time constant for a first order filter that will be applied to both the A1 and A2 analog inputs. The Drive operation becomes more stable the longer the time programmed, but it becomes less responsive to rapidly changing analog signals.

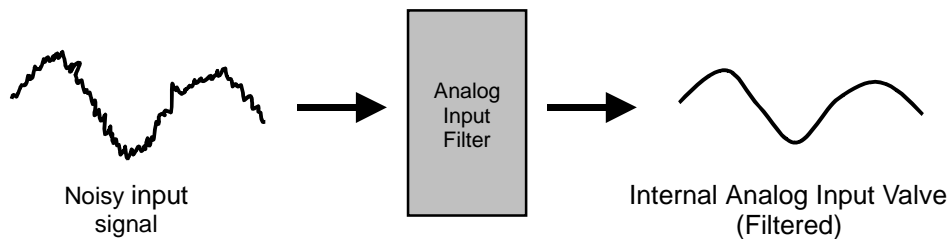

Fig. 31 Analog Input Filter Time Constant Effect on “Noisy” Signal

### ■ H3-13 Master Frequency Reference Terminal Selection

Setting	Description
0	Main Fref= A1(factory default)
1	Main Fref= A2

Parameter H3-13 allows the programmer to select which analog input will serve as the Speed Command input when “Terminals” are selected as the Auto Mode Speed source (b1-01= “1: Terminals”), or Terminal is selected as the reference source for the Hand mode (b1-12= “1: Terminals”). For the A2 analog input to be an effective selection for the H3-13 parameter, parameter H3-09 must be configured as Aux Reference (H3-09= “2: Aux Reference”).

If H3-09≠2, then the A1 analog input will be used regardless of the setting of parameter b1-12.

---

### ◆ L2 Momentary Power Loss Ride-thru Function

When momentary power loss recovery is enabled (L2-01≠0), a speed search is executed to catch the potentially spinning motor shaft. This speed search will occur regardless of the setting of b3-01 “Speed Search Selection”.

#### ■ L2-01 Momentary Power Loss Detection Selection

Setting	Description
0	Disabled
1	PwrL Ride Thru t
2	CPU Power Active (factory default)

#### ■ L2-02 Momentary Power Loss Ride-Thru Time

Setting Range: 0.0 to 25.5 Seconds

Factory Default: Model Dependent

The Drive allows different responses to momentary power losses. The setting of L2-01 determines whether the Drive attempts to restart after a short loss of incoming AC power and for what length of time this capability remains active.

If L2-01= “0: Disabled”, the Drive detects a UV1 fault 15ms after power loss and automatic restarting is disabled. The Drive cannot restart until the external run command is removed and the UV1 fault is reset.

If L2-01= “1: PwrL Ride Thru t”, the Drive restarts without the UV1 fault if power is returned within the time specified in L2-02, the Momentary Power Loss Ride-thru Time. During the power loss but before the fault trip, the digital operator will display a UV alarm. If L2-02 is set for a time longer than the control power supply can be sustained, a UV1 fault will not occur and the Drive restarts upon the return of AC power. The time that the control power supply can be maintained varies with Drive size. The larger the Drive, the greater the potential ride-thru time.

If L2-01= “2: CPU Power Active”, the Drive ignores L2-02 and attempts a restart as long as the control power supply is still able to maintain a minimal voltage level. In effect, setting L2-01= “2: CPU Power Active” (factory default) is programming the Drive for maximum Power Loss Ride-thru. An equivalent setting is L2-01= “1: PwrL Ride Thru t”, with L2-02 set to a time longer than the control power supply can be maintained after power is lost.

**Note:** The run command must be held during power loss for any power loss ride-thru capability to be possible. It is for this reason that 3-wire control is not recommended for use with the Momentary Power Loss function.

## ◆ L3 Stall Prevention

### ■ L3-01 Stall Prevention Selection During Accel

Setting	Description
0	Disabled
1	General Purpose ( <i>factory default</i> )
2	Intelligent

### ■ L3-02 Stall Prevention Level During Accel

Setting Range: 0 to 200% of Drive rated output current

Factory Default: 120% of Drive rated output current

The stall prevention during acceleration function adjusts the acceleration time in order to prevent OC fault trips during acceleration. If L3-01= “0: Disabled”, stall prevention is disabled. If the load is large enough and the acceleration time short enough the Drive may fault and stop.

If L3-01= “1: General Purpose”, then the standard stall prevention function is enabled. When the output current exceeds the level set by the L3-02 parameter, the Drive will discontinue accelerating and maintain speed. If, during acceleration, the output current comes within 15% of the level set by parameter L3-02, the acceleration time is lengthened. Once the output current level has dropped below the L3-02 level, acceleration will begin again with the acceleration rate reaching the programmed rate once again 15% below the L3-02 level.

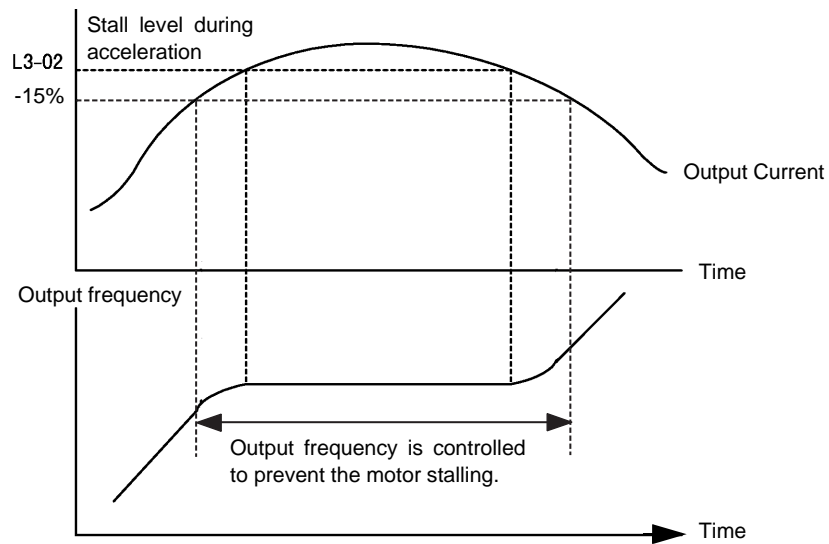

Fig. 32 Detailed Time Chart for Stall Prevention During Acceleration

If L3-01= “2: Intelligent”, the intelligent stall prevention is enabled. The active acceleration time is ignored and the Drive will attempt to accelerate as quickly as possible without exceeding the L3-02 output current level.

#### IMPORTANT

Stall Prevention during Acceleration is not effective when the output frequency is less than 6Hz.

The following figure demonstrates acceleration when L3-01= “1: General Purpose”.

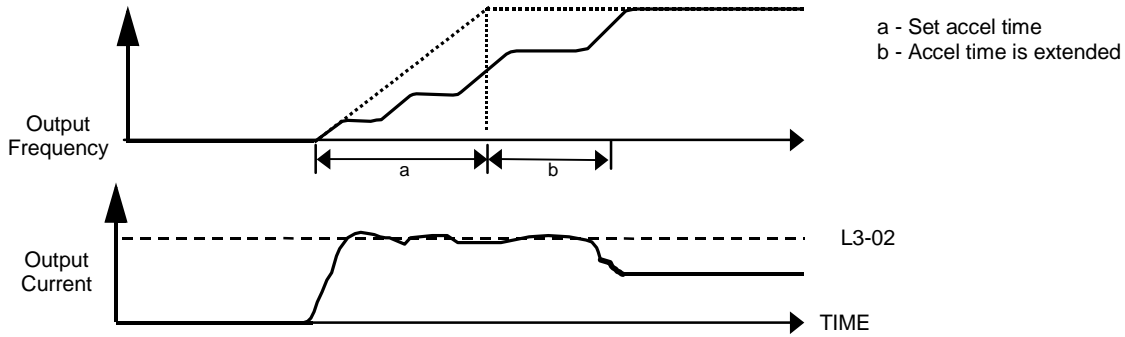

Fig. 33 Time Chart for Stall Prevention During Acceleration

The L3-02 parameter is set as a percentage of the Drive rated output current. If the motor capacity is small compared to the Drive’s capacity, or if the motor stalls during acceleration, lower the set value of L3-02.

### ■ L3-04 Stall Prevention Selection During Decel

Setting	Description
0	Disabled
1	General Purpose ( <i>factory default</i> )
2	Intelligent
3	Stall prev w/R

The stall prevention during deceleration function adjusts the deceleration time in order to prevent OV fault trips during deceleration. If L3-04= “0: Disabled”, stall prevention is disabled and if the load is large and the deceleration time short enough the Drive may fault and stop.

If L3-04= “1: General Purpose”, then the standard stall prevention function is enabled. If, during deceleration, the DC Bus voltage exceeds the stall prevention level (see table below), the Drive will discontinue decelerating and maintain speed. Once the DC Bus voltage has dropped below the stall prevention level, the deceleration will continue down to the Speed Command level. See figure below.

Drive Voltage		Stall Prevention Level during Deceleration (V)
240Vac		380
480Vac	E1-01 ≥ 400Vac	760
	E1-01 < 400Vac	660

If L3-01= “2: Intelligent”, the intelligent stall prevention is enabled. The active deceleration time is ignored and the Drive will attempt to decelerate as quickly as possible without causing the DC Bus voltage to exceed the stall prevention level.

The following figure demonstrates acceleration when L3-04= “1 General Purpose”.

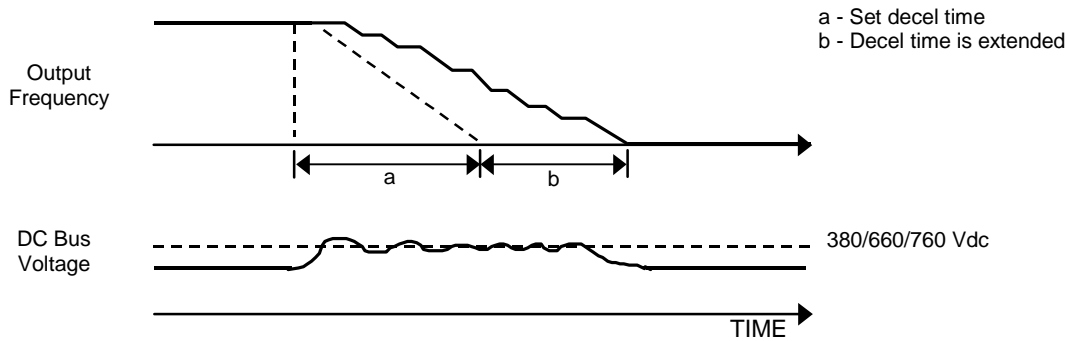

Fig. 34 Time Chart for Stall Prevention During Deceleration

### ■ L3-05 Stall Prevention Selection During Running

Setting	Description
0	Disabled
1	Decel Time 1 ( <i>factory default</i> )
2	Decel Time 2

### ■ L3-06 Stall Prevention Level During Running

Setting Range: 30 to 200% of Drive rated output current

Factory Default: 120% of Drive rated output current

The Stall Prevention During Running function will attempt to avoid a Drive OC fault occurrence while the Drive is operating at a constant speed. If L3-05= “0: Disabled”, the Drive may fault if the load increases sufficiently to cause the output current to reach the OC fault level (180% of Drive rated output current).

If L3-05= “1: General Purpose”, the Drive is outputting a constant speed, and the Drive’s output current level exceeds the level set by parameter L3-06 for more than 100 ms the Drive will begin to decelerate at the rate specified by parameter C1-02. The Drive will continue to decelerate until the output current level drops below the L3-06 level (less a 2% hysteresis). Once the output current drops below the L3-06 – 2% level the Drive will begin to accelerate at the currently active acceleration rate (either C1-01 or C1-03).

If L3-05= “2: Decel Time 2”, the Drive will function as described above except C1-04 will be used instead of C1-02 as the deceleration rate used when the output current exceeds L3-06 for more than 100 ms.

The following figure demonstrates acceleration when L3-05≠0.

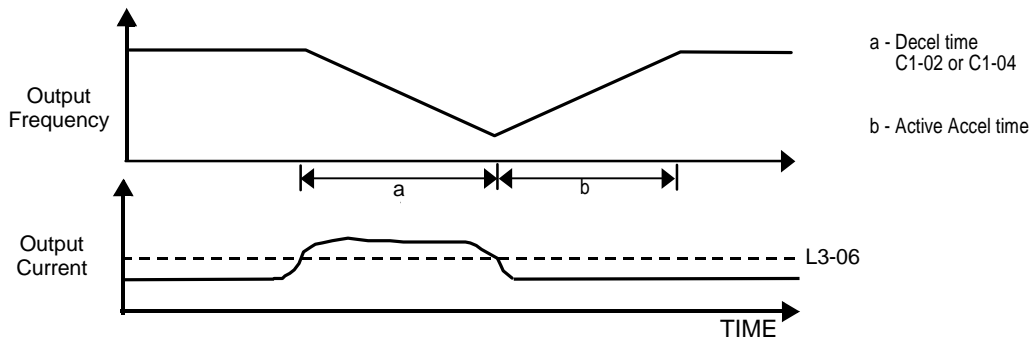

Fig. 35 Time Chart for Stall Prevention Level During Running

The L3-06 parameter is set as a percentage of the Drive rated output current. If the Drive still faults when L3-05≠0, then either lower the L3-06 or adjust the C1-02 or C1-04 settings for a quicker deceleration.

## ◆ L4 Speed Command Loss Detection

### ■ L4-01 Speed Agreement Detection Level

Setting Range: 0.0 to 200.0 Hz  
Factory Default: 0.0 Hz

### ■ L4-02 Speed Agreement Detection Width

Setting Range: 0.0 to 20.0 Hz  
Factory Default: 2.0 Hz

Parameters L4-01 and L4-02 are user specified levels for use with the Fref/Fout Agree 1, Fref/Set Agree 1, and Freq Detect 1 & 2 digital output functions. Please refer to the H2 Digital Output Parameters in the Programming Manual for more information.

### ■ L4-05 Frequency Reference Loss Detection Selection

Setting	Description
0	Disabled
1	Enabled @ % of PrevRef ( <i>factory default</i> )

### ■ L4-06 Frequency Reference at Loss of Frequency Reference

Setting Range: 0.0 to 100.0% of previous speed command  
Factory Default: 80.0% of previous speed command

The Drive can be configured to compensate for the loss of its external speed command. An external speed command is considered lost if it drops 90% of its value in 400mS or less.

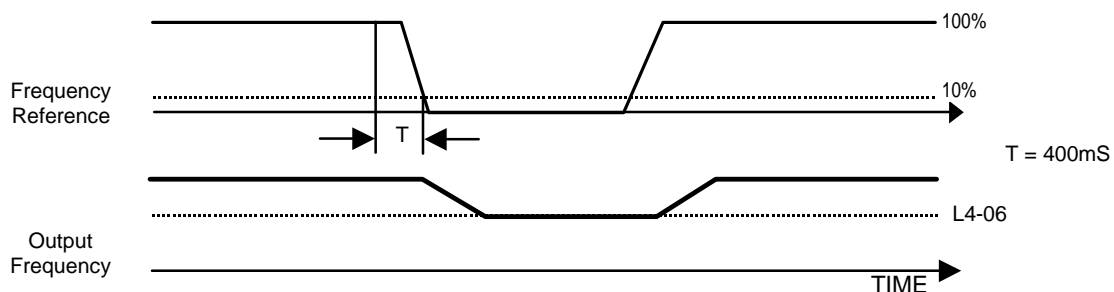

Fig. 36 Loss of Frequency Reference Timing Diagram

To enable Frequency loss detection, set L4-05= “1: Enabled @ % of PrevRef”. If Frequency Reference Loss Detection is enabled and the reference is lost, the Drive continues to operate at the speed commanded by parameter L4-06. When the speed command returns, the Drive again follows the speed command.

Setting H2-01/H2-02= “C: Loss of Ref”, configures a digital output as a Frequency Reference Loss indication only when L4-05= “1: Enabled @ % of PrevRef”.

## ◆ L5 Fault Restart

### ■ L5-01 Number of Auto Restart Attempts

Setting Range: 0 to 10  
 Factory Default: 0

### ■ L5-02 Auto Restart Operation Selection

Setting	Description
0	No Flt Relay ( <i>factory default</i> )
1	Flt Relay Active

### ■ L5-03 Maximum Restart Time After Fault

Setting Range: 0.5 to 600.0 Seconds  
 Factory Default: 180.0 Seconds

All major faults will cause the Drive to stop. For some faults it is possible to configure the Drive to attempt a restart automatically. After the fault occurs, the Drive baseblocks for L2-03 seconds. After the baseblock is removed the Drive checks if a fault condition still exists. If no fault condition exists the Drive will attempt to restart the motor. If the restart is successful, the Drive performs a Speed Search (Regardless of the status of b3-01 “Speed Search Selection”) from the set speed command and the Auto Restart Attempts count is increased by one. Even if the restart fails the restart count is increased by one as long as the Drive attempted to rotate the motor. The restart count will not be incremented if the restart is not attempted due to a continuing fault condition, (i.e. an OV fault). The Drive waits L5-03 seconds before attempting another restart.

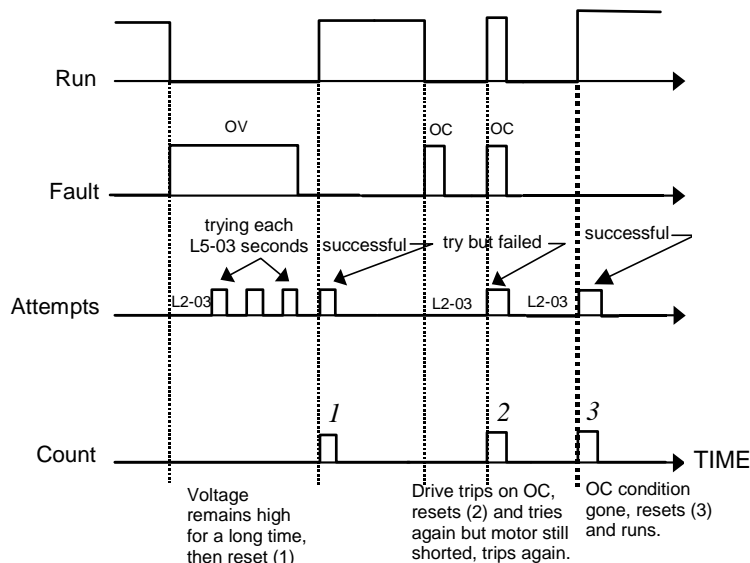

Fig. 37 Automatic Restart Timing Diagram

The auto restart count is reset back to 0 if any of the following occur:

- No further faults for ten minutes after the last retry.
- The Drives power is turned off (the Drive must be without power long enough to let control power dissipate).
- The SHIFT/RESET key is pushed after the last reset attempt.

The setting of parameter L5-02 determines whether the fault output (MA-MB) will be closed during an auto restart attempt. The setting of L5-02 can be important when interfacing the Drive with other equipment.

The following faults will allow the Auto Restart function to initiate:

- OC (Overcurrent)
- LF (Output Open Phase)
- PF (Input Phase Loss)
- PUF (DC Bus Fuse)
- OL1 (Motor Overload)
- OL3 (Overtorque)
- OL2 (Drive Overload)
- OV (DC Bus Overvoltage)
- GF (Ground Fault)
- UV1 (DC Bus Undervoltage)
- OH1 (Overheat)

In order for auto restart after a UV1 fault, Momentary Power Loss Ride-thru must be enabled (L2-01= “1: PwrL Ride Thru t”, or “2: CPU Power Active”). Setting H2-01 or H2-02 equal to “1E” configures a digital output as “Restart Enabled” to signal if an impending auto restart is possible.

## ◆ L6 Torque Detection

### ■ L6-01 Torque Detection Selection 1

Setting	Description
0	Disabled ( <i>factory default</i> )
1	OL@SpdAgree - Alm
2	OL At Run -Alm
3	OL@SpdAgree - Flt
4	OL At Run - Flt
5	UL@SpdAgree - Alm
6	UL at Run - Alm
7	UL@SpdAgree - Flt
8	UL At Run - Flt

### ■ L6-02 Torque Detection Level 1

Setting Range: 0 to 300% of Drive rated output current

Factory Default: 15% of Drive rated output current

### ■ L6-03 Torque Detection Time 1

Setting Range: 0.0 to 10.0 Seconds

Factory Default: 10.0 Seconds

The Drive can be programmed to indicate when either an overtorque or an undertorque conditions exist. A digital output must be programmed for “Torque Detection”, (H2-01/H2-02= “B: Trq Det 1 N.O.” or “17: Trq Det 1 N.C.”). A warning of an overtorque condition can indicate a jam and an undertorque condition can indicate a broken belt, no water in a pump, or other loss of load.

To configure Torque Detection requires the following decisions:

1. Do you wish to check for an overtorque condition or an undertorque condition?
2. Do you wish to check for the torque condition whenever the drive is running or only at speed agree? Nuisance detection during acceleration, when variable torques are normally required, can be avoided.
3. Do you want the drive to fault if the torque condition is detected or only alarm and continue operation?

The following table can help choose the proper setting for Torque Detection Selection 1 to get the wanted results.

L6-01 Setting	Overtorque	Undertorque	Fault	Alarm	Always Detected	Only Detected @ Spd Agree
0	Torque Detection Disabled					
1	X			X		X
2	X			X	X	
3	X		X			X
4	X		X		X	
5*		X		X		X
6		X		X	X	
7		X				X
8		X			X	

\*Suggested settings for Loss of Load indication

After selecting the proper detection scheme the Torque Detection Level (L6-02) must be specified. If the current level read by the output current transformers rises above (overtorque) or drops below (undertorque) this level, and remains there for at least the Torque Detection Time (L6-03), then the Torque Detection Function will change the state of any digital output configured for Torque Detection (H2-01/H2-02= "B: Trq Det 1 N.O.", or "17: Trq Det 1 N.C.").

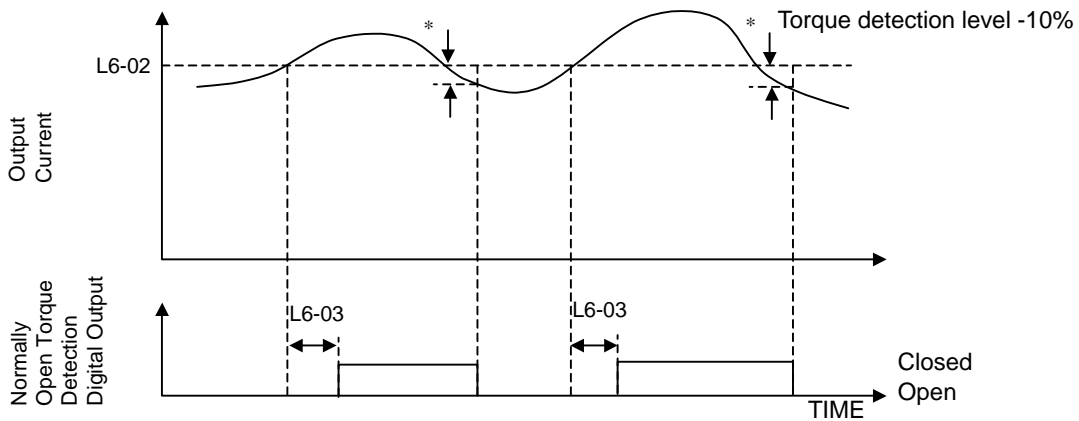

\* When the output current drops below the Torque Detection Level by approximately 10% of the Drive's rated output current the digital output is reset.

Fig. 38 Over Torque Detection

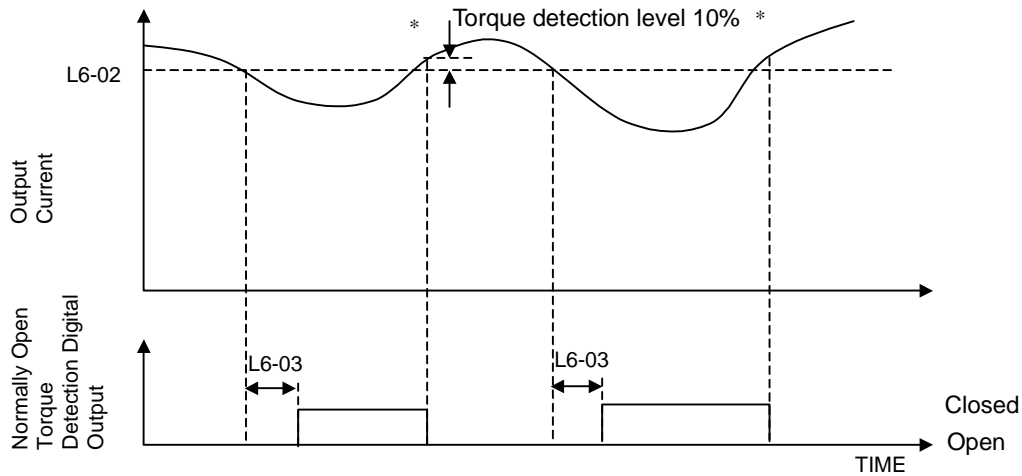

\* When the output current rises above the Torque Detection Level by approximately 10% of the Drive's rated output current the digital output is reset.

Fig. 39 Under Torque Detection

## ◆ L8 Hardware Protection

### ■ L8-02 Overheat Pre-Alarm Level

Setting Range: 50 to 130°C

Factory Default: 95°C

### ■ L8-03 Overheat Pre-Alarm Operation Selection

Setting	Description
0	Ramp to Stop (Decel Time C1-02)
1	Coast to Stop
2	Fast-Stop (Decel Time C1-09)
3	Alarm Only
4	OH Alarm and Reduce ( <i>factory default</i> )

The Drive is capable of warning the operator of an impending heatsink over-temperature fault via an OH pre-alarm. The level at which the pre-alarm will activate is determined by the setting of parameter L8-02. Measurement of the heatsink temperature is done with several strategically mounted thermistors. If any of the heatsink thermistors measure a temperature in excess of the setting of L8-02, the Drive will fault (OH2) and either: ramp to stop using the C1-02 deceleration rate (L8-03= “0: Ramp to Stop”), coast to stop (L8-03= “1: Coast to Stop”), ramp to stop using the C1-09 fast stop deceleration rate (L8-03= “2: Fast-Stop”), alarm (OH) and continue running (L8-03 = “3: Alarm Only”), alarm (OH) and continue running but at a reduced speed (L8-03= “4: Alarm & Reduce”). If L8-03= 4: Alarm and Reduce, the Drive will continue to run but will reduce the speed to the level determined by parameter L8-19. Refer to the description for parameter L8-19.

If a digital output is configured for OH Prealarm (H2-01= “20: OH PreAlarm”), it will close whenever the heatsink temperature is greater than the L8-02 level no matter what the setting is of L8-03.

### ■ L8-06 Input Phase Loss Detection Level

Setting Range: 0.0 to 25.0% of Drives OV Trip point

Factory Default: KVA Dependent

The Drive checks for a lost input phase by monitoring the DC Bus voltage ripple. After an initial delay of approximately 12 seconds, the Drive will sample the DC BUS voltage every 1.28 seconds to determine the minimum and maximum voltage readings. The difference between the minimum and maximum voltage is averaged over ten consecutive scans. If this “averaged” value is greater than the trip level as determined by L8-06 (L8-06 x 400 for 200 volt class Drives; L8-06 x 800 for 400 volt class Drives) the Drive shuts down and displays “PF”, an input phase loss fault.

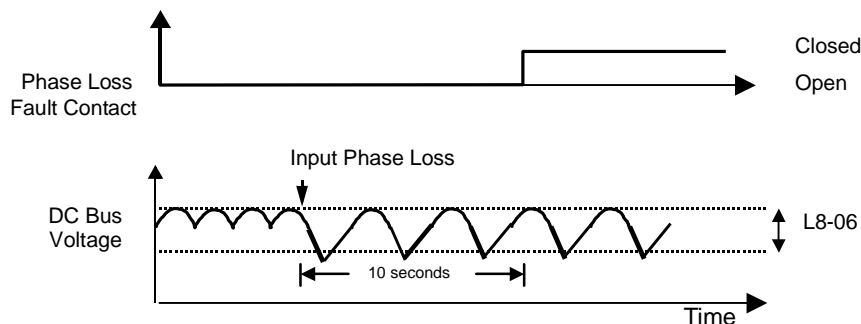

Fig. 40 Input Phase Loss Detection Diagram

## ■ L8-09 Output Ground Fault Detection Selection

Setting	Description
0	Disabled
1	Enabled ( <i>factory default</i> )

The Drive has a ground fault detection circuit that activates when the current to ground exceeds 50% of the Drive's rated output current. The current to ground is determined by comparing the measured current on each of the output phases. If the current to ground is determined to be above 50% of the Drive's rated output current the digital operator will display a GF and the Drive will coast to stop.

## ■ L8-10 Heatsink Cooling Fan Operation Selection

Setting	Description
0	Fan On-Run Mode ( <i>factory default</i> )
1	Fan Always On

## ■ L8-11 Heatsink Cooling Fan Operation Delay Time

Setting Range: 0 to 300 Seconds

Factory Default: 300 Seconds

Parameters L8-10 and L8-11 allow the Drive programmer to customize the heatsink cooling fan operation. Parameter L8-10 determines whether the cooling fans are always ON whenever the Drive is powered (L8-10= "1: Fan Always On") or if the cooling fans are only ON when the Drive is in a Run condition (L8-10= "0: Fan On-Run Mode").

Parameter L8-11 is a delayed OFF for the cooling fan if L8-10= "0: Fan On-Run Mode". When the cooling fans are set to turn OFF when the Run command is removed, parameter L8-11 will cause the fans to continue cooling the Drive for the amount of time programmed into L8-11 after the Run command is actually removed. The Drive can be programmed to allow the cooling fan to run for up to 5 minutes (factory default) after the run command is removed.

Both parameters are intended to extend fan life while still providing sufficient cooling for proper Drive operation.

## ■ L8-19 Overheat Frequency Reference Reduction Level

Setting Range: 0.0 to 100.0% of maximum frequency

Factory Default: 20.0% of maximum frequency

When the heatsink temperature reaches the OH Pre-alarm level (L8-02) and the Overheat Pre-Alarm Operation Selection parameter is set for Alarm and Reduce (L8-03= "4: OH Alarm & Reduce"), the L8-19 parameter sets the amount of speed decrease that will be applied to the Speed Command in order to lower the heatsink temperature. The decrease in speed will lower the current being switched and conducted by the heat producing output transistors of the Drive.

Parameter L8-19 is set in percentage of maximum frequency (E1-04).

---

## ◆ o1 Monitor Configuration

### ■ o1-01 User Monitor Selection

Setting Range: 6 to 53

Factory Default: 6

Setting	Description
6	Output Voltage ( <i>factory default</i> )
7	DC Bus Voltage
8	Output Power
10	Input Terminal Status
11	Output Terminal Status
12	Drive Operation Status
13	Cumulative Operation Time
14	Software Number
15	Terminal A1 Input Voltage
16	Terminal A2 Input Voltage
18	Motor Secondary Current ( $I_q$ )
20	Output Frequency After Soft Start
24	PI Feedback Value
28	CPU Number
34	First Parameter Causing an OPE
36	PI Input
37	PI Output
38	PI Setpoint
39	Memobus Communication Error Code
40	Heatsink Cooling Fan Operation Time
51	Auto Mode Frequency Reference Value
52	Hand Mode Frequency Reference Value
53	PI Feedback 2 Value

■ **o1-02 Power-On Monitor**

Setting	Description
1	Frequency Reference ( <i>factory default</i> )
2	Output Frequency
3	Output Current
4	User Monitor (set by o1-01)

When the Drive is powered up, three monitors are displayed on the digital operator. The first and largest monitor is the “Power-On” monitor. The factory default “Power-On monitor” is Speed Command (U1-01). Below the Speed Command monitor are the next two sequential monitors, Output Frequency (U1-02) and Output Current (U1-03). Pressing the INCREASE key once scrolls the monitors to show the User Monitor as selected by o1-01. The factory default for o1-01 is the Output Voltage monitor (U1-06).

The active monitor displayed when the Drive is powered on can be changed to either be U1-01 (Speed Command), U1-02 (Output Frequency), U1-03 (Output Current), or the User Monitor. Whichever monitor is selected as the Power-On top monitor, the two monitors displayed below it are the next two sequential monitors. See example below.

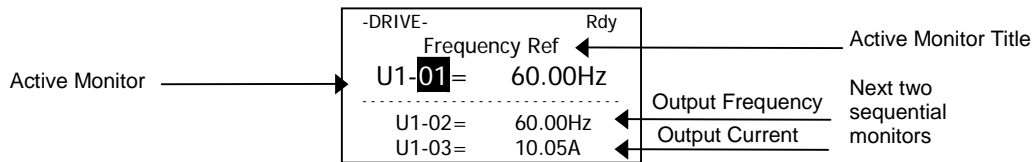

For example, if the Drive needs to display the Elapsed Timer as the Power-On monitor, then o1-01 must be set to “13” and o1-02 must be set to “4”. The next time Drive power is cycled, the digital operator displays U1-13 (Elapsed Time), U1-14 (Flash ID), and U1-15 (Term AI Level).

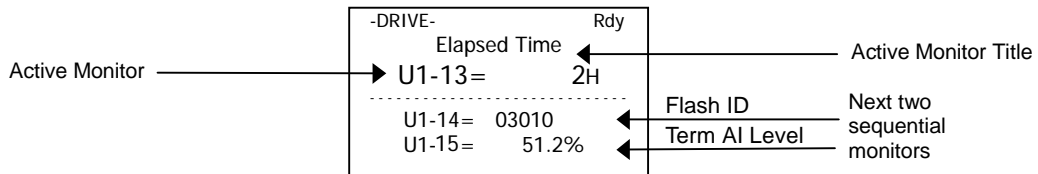

## ■ o1-03 Digital Operator Display Scaling

Setting	Description
0	Hz ( <i>factory default</i> )
1	%
2 - 39	RPM (Enter the # of Motor Poles)
40 - 39999	User Display

Parameter o1-03 allows the programmer to change the units in which the speed monitors and some speed parameters are displayed. The o1-03 parameter will change the units of the following:

- U1-01 (Frequency Reference Monitor)
- U1-02 (Output Frequency Monitor)
- U1-20 (Output Frequency after Soft Start)
- d1-01 through d1-17 (Preset Frequency References and Jog Reference)

The table below details how the setting of o1-03 will affect the way the listed monitors and parameters will be displayed.

If o1-03 is:	The frequency format is
0	0.01 Hz
1	0.00%
2 through 39 (enter the # of motor poles)	0 RPM
40 through 39999	Engineering Units

The factory default setting (o1-03= “0”) sets the Drive up to display the affected monitors and parameters in terms of hertz (Hz).

If the speeds seem more natural in terms of percentage of maximum, set o1-03= “1”. If the speeds are easier to work with when displaying the equivalent synchronous motor RPM, set o1-03= [the number of motor poles]. If another engineered unit, such as fpm or gpm, is desired, set o1-03= xxxx where

X X X X X  
 Digit 5 Digit 4 Digit 3 Digit 2 Digit 1

Digits 1 through 4 set the desired number to be displayed at 100% speed.

Digit 5 determines the number of decimal places in the displayed number.

If Digit 5 = 0    number format is XXXX  
 If Digit 5 = 1    number format is XXX.X  
 If Digit 5 = 2    number format is XX.XX  
 If Digit 5 = 3    number format is X.XXX

For example:

If o1-03= 10425, then at full speed the digital operator will display “42.5”. Configuring parameter o1-03 for displaying in terms of an engineering unit is only appropriate if the actual display units have a linear relationship with the actual output speed.

## ■ o1-05 LCD Contrast Adjustment

Setting Range: 1, 3 or 5

Factory Default: 3

The contrast setting of the LCD display of the digital operator can be adjusted by the setting of parameter o1-05. The higher the number programmed into o1-05, the darker the background will become. Set o1-05 to the value that makes the LCD the easiest to view at the normal viewing distance and angle.

## ■ o1-06 User Monitor Selection Mode

Setting	Description
0	3 Mon Sequential ( <i>factory default</i> )
1	3 Mon Selectable

## ■ o1-07 Second Line User Monitor

Setting Range: 1 to 53

Factory Default: 2

## ■ o1-08 Third Line User Monitor

Setting Range: 1 to 53

Factory Default: 3

Normally the monitors shown directly below the active monitor are the next two sequential monitors. If o1-06 (User Monitor Selection Mode) is set to “1: 3 Mon Selectable”, those two monitors are locked as specified by parameters o1-07 and o1-08 and will not change as the top parameter is scrolled with the INCREASE and DECREASE keys.

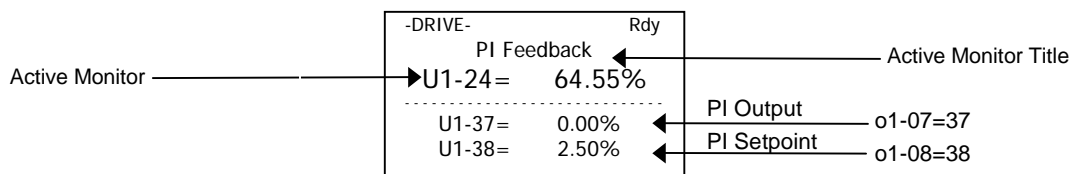

For Example:

The Display above showing PI Feedback, PI Output and PI Setpoint would be useful when setting up a PI Control Loop.

---

## ◆ o2 Key Selections

### ■ o2-03 User Parameter Default Value

Setting	Description
0	No Change
1	Set Defaults
2	Clear All

The Drive gives the option of configuring any and all of the programming parameters and then saving the parameters as “User Initialization Values”. After configuring the Drive, set parameter o2-03= “1: Set Defaults”, to save the parameters to a User Initialization memory location. Once this has been done, the “Initialize Parameters” parameter (A1-03) will offer the choice of “1110:User Initialize”. Choosing A1-03= “1110: User Initialized”, will reset all modified parameters back to what they were the last time they were saved using o2-03.

The choice of setting A1-03= “1110: User Initialized”, is unavailable until first setting the User Initialization parameters using o2-03. Once a User Initialization is set (saved), it can be cleared by setting o2-03= “2: Clear All”. After clearing the User Initialization parameters, the choice of “1110: User Initialize” is no longer a available in A1-03.

### ■ o2-05 Frequency Reference Setting Method Selection

Setting	Description
0	Disabled
1	Enabled ( <i>factory default</i> )

The factory default setting of the Frequency Reference Setting Method parameter (o2-05= “1: Enabled”) dictates that when setting a Speed Command via the digital operator (“Hand” mode), it is not necessary to press the DATA/ENTER key before the Drive will begin to accelerate or decelerate to the new set speed. This is referred to as MOP (Motor Operated Potentiometer) type functionality. When o2-05= “1: Enabled”, the speed command is stored to memory 5 seconds after the INCREASE or DECREASE keys are released.

When o2-05= “0: Disabled”, the digital operator INCREASE and DECREASE keys will change the speed command but the Drive will not accelerate or decelerate to the new speed command until the DATA/ENTER key is pressed. In order to change the Speed Command in the HAND mode, U1-01 must be the top monitor and then the ENTER key must be pressed in order to access the Speed Command function. This in not to be confused with pressing the ENTER key in order to achieve a change in speed using the INCREASE and DECREASE keys, which is the subject of parameter o2-05.

## ■ o2-06 Operation Selection when Digital Operator is Disconnected

Setting	Description
0	Disabled
1	Enabled ( <i>factory default</i> )

Leaving o2-06 enabled will cause the Drive to fault, when the digital operator is removed, even if it's not outputting to the motor. The reset key on the digital operator will need to be pressed after reconnecting the digital operator to reset the fault and continue normal operation.

If o2-06 = "0: Disabled" then the Drive will not fault if the digital operator is disconnected, but the Drive will discontinue motor operation. If full Drive operation is required while the digital operator is removed set o2-06 = "0: Disabled" and o2-15 = "0: Disabled" (Hand Key Function). If both o2-06 and o2-15 are disabled then the digital operator can be disconnected without disturbing Drive operation.

## ■ o2-07 Cumulative Operating Time Setting

Setting Range: 0 to 65535 Hours  
 Factory Default: 0 Hours

## ■ o2-08 Cumulative Operation Time Selection

Setting	Description
0	Power-On Time
1	Running Time ( <i>factory default</i> )

The Drive features an Elapsed Timer monitor that records in units of hours. The Elapsed Timer monitor is U1-13. Parameter o2-08 programs this function to either accumulate elapsed hours based on time the Drive is powered (o2-08= "0: Power-On Time") or time the Drive is running (o2-08= "1: Running Time"). The Drive is considered "running" anytime there is an active run command or when the Drive is outputting voltage (i.e. including during deceleration).

-DRIVE-	Rdy
Elapsed Time	
U1-13= 0H	
-----	
U1-14= 03010	
U1-15= 34.1%	

Parameter o2-07 allows manual adjustment of the Elapsed Timer, primarily to accommodate maintenance or control board replacement in the event of damage. To reset the Elapsed Timer back to zero, set o2-07= 0.

---

## ◆ o3 Digital Operator Copy Function

### ■ o3-01 Copy Function Selection

Setting	Description
0	COPY SELECT ( <i>factory default</i> )
1	INV→OP READ
2	OP→INV WRITE
3	OP↔INV VERIFY

**Note:** The copy function is disabled when serial communication is active.

### ■ o3-02 Read Allowed Selection

Setting	Description
0	Disabled ( <i>factory default</i> )
1	Enabled

The digital operator has parameter COPY capabilities via built in non-volatile memory. The digital operator can READ all of the parameters in the Drive and store them for later WRITE back to the Drive or into a Drive with the same product code and software number. In order to read the parameter values and store them in the digital operator, select o3-02= “1: Enabled”. If you attempt to READ the data, which overwrites any previously stored data, without first setting o3-02= “1: Enabled”, you will get the following error:

-ADV-  PRE READ IMPOSSIBLE
-------------------------------------

After setting o3-02= “1: Enabled”, it is possible to store parameter values in the digital operator by setting o3-01=1 (INV→OP READ).

A successful READ of the parameter values will display:

-ADV-  READ READ COMPLETE
------------------------------------

An error may occur while saving the parameter values to the digital operator’s memory. If an error is displayed, press any key to cancel the error display and return to parameter o3-01. Error displays and their meanings are covered in *Chapter 6: Diagnostics and Troubleshooting* of the E7 Users Manual (TM.E7.01). To COPY parameter values into a Drive, set o3-01= “2: OP→INV WRITE”. During the writing of the parameter values into the Drive the digital operator will display:

-ADV-  
COPY  
OP→INV COPYING

A successful COPY of the parameter values will display:

-ADV-  
COPY  
COPY COMPLETE

An error may occur while writing the parameter values to the Drive. If an error is displayed, press any key to cancel the error display and return to parameter o3-01. Error displays and their meanings are covered in *Chapter 6: Diagnostics and Troubleshooting* of the E7 Users Manual (TM.E7.01).

It is possible to compare the parameter values stored in the digital operator with the parameter values currently in the Drive by using the VERIFY function. This VERIFY function should not be confused with the “-VERIFY-“ that is displayed on the digital operator when viewing the “Modified Constants” menu. To VERIFY the parameter values in the Drive as compared with those stored in the digital operator, set o3-01= “3: OP<-->INV VERIFY”. During the comparing of the parameter values into the Drive the digital operator will display:

-ADV-  
VERIFY  
DATA VERIFYING

A successful VERIFY of the parameter values will display:

-ADV-  
VERIFY  
VERIFY COMPLETE

If all the parameter values stored in the digital operator do not match those programmed in the Drive, the digital operator displays the following:

-ADV-

VYE  
VERIFY ERROR

The digital operator will not display which parameters did not match, only that the verification found discrepancies in some parameter values.

**NOTE:** In order to properly use the COPY or VERIFY functions, the following Drive specifications must be identical between the Drive that the parameters were read from and the Drive that the parameters are to be written to:

- Model Number (e.g. CIMR-E7U2015)
- Software Number (e.g. 03011 also known as FLASH ID)

Yaskawa offers DriveWizard™ software that can also READ, COPY, and VERIFY Drive parameter values. DriveWizard™ lists all discrepancies between the Drive and a pre-saved parameter file when verifying is performed.

To use DriveWizard first select o2-15= “0: Disabled” and select o2-06= “0: Disabled” then remove the digital operator/keypad and attach the DriveWizard cable in its place.

---

## ◆ T1 Auto-Tuning

### ■ T1-02 Motor Rated Power

Setting Range: 0.00 to 650.00 kW  
Factory Default: Model Dependent

### ■ T1-04 Motor Rated Current

Setting Range: Model Dependent  
Factory Default: Model Dependent

Auto tuning is recommended to achieve optimum performance. In addition, the Drive requires Line-To-Line Resistance auto-tuning before it can properly perform the Estimated Speed Search method. This method of speed search allows for bi-directional speed search. The T1 parameters are found under the Auto-Tuning menu.

To perform auto-tuning follow these steps:

1. In T1-02, enter the rated power in kilowatts (kW) of the motor attached to the Drive. If the motor nameplate lists the rated power in terms of horsepower (HP), use the following formula to convert to kW before setting the value of T1-02:

$$\text{kW} = \text{HP} \times 0.746$$

2. In T1-04, enter the Full Load Amps (FLA) as stamped on the motor's nameplate.
3. Press the INCREASE key once to display this:

-ATUNE-	Rdy
Auto-Tuning	
-----	
0Hz/ 0.00A	
Tuning Ready ?	
Press HAND key	

4. If ready, press the HAND key once to start auto-tuning. This process will last for approximately 15 seconds. Once auto-tuning is finished, the digital operator will display this:

-ATUNE-
Tune Successful
-----
0Hz/ 0.00A

5. To exit the Auto-Tuning menu, press the MENU key once.

NOTE: It is possible to get a "Data Invalid" error if either T1-02 or T1-04 fall outside the range of what the Drive will accept as reasonable levels for the programmed size of drive (o2-04).

Notes:

# Chapter 6

## Diagnostics & Troubleshooting

---

*This chapter describes diagnostics and troubleshooting for the Drive.*

Fault Detection .....	6-2
Alarm Detection .....	6-8
Operator Programming Errors (OPE).....	6-11
Auto-Tuning Faults .....	6-12
Digital Operator COPY Function Faults .....	6-13
Troubleshooting .....	6-14
Main Circuit Test Procedure.....	6-20
Drive Date Stamp Information.....	6-24

# Fault Detection

When the Drive detects a fault, the fault information is displayed on the digital operator, the fault contact closes, and the motor coasts to stop. (However, a fault with selectable stopping method will operate according to the stopping method selected.)

- If a fault occurs, take appropriate action according to the table by investigating the cause.
- To restart, reset the fault with any of the following procedures:
  - Turn ON the fault reset signal.
  - Set “14: Fault Reset” to a multi-function digital input (H1-01 to H1-05).
  - Press the RESET key of the digital operator.
  - Shut off the Drive input power once, and then turn on again.

**WARNING**

The Run Command (Start Command) needs to be removed prior to resetting a fault. Resetting a fault by removing and reapplying power to the Drive while the Run Command is applied, may cause the Drive to start unexpectedly. Therefore, make sure all personnel are clear from the Drive, motor, and machine prior to resetting the Drive.

Table 6.1 Fault Displays and Processing

Digital Operator Display	Description	Cause	Corrective Action
BUS Option Com Err	Option Communication Error After initial communication was established, the connection was lost.	Connection is broken, master has stopped communicating	Check all connections, verify all user-side software configurations.
CE Memobus Com Err	Modbus Communication Error Control data was not received correctly for two seconds	Connection is broken, master has stopped communicating	Check all connections, verify all user-side software configurations.
CPF00 COM-ERR(OP&INV)	Operator Communication Fault 1 Transmission between the Drive and the digital operator cannot be established within 5 seconds after supplying power	Digital operator cable not securely connected, digital operator defective, control board defective	Remove the digital operator once and then reinstall it
	External RAM of CPU is defective	Control circuit damage	Cycle power off and on to the Drive Replace the Drive
CPF01 COM-ERR(OP&INV)	Operator Communication Fault 2 After communication started with the digital operator, a communication fault occurred for 2 seconds or more	Digital operator cable not securely connected, digital operator defective, control board defective	Remove the digital operator once and then reinstall it
			Cycle power off and on to the Drive
			Replace the Drive
CPF02 BB Circuit Err	Baseblock Circuit Fault Baseblock circuit fault at power-up	Gate array hardware failure during power-up	Perform a factory initialization
			Cycle power off and on to the Drive
			Replace the control board
CPF03 EEPROM Error	EEPROM Fault EEPROM fault, check sum not valid	Noise or spike on the control circuit input terminals	Perform a factory initialization
			Cycle power off and on to the Drive
			Replace the control board

Table 6.1 Fault Displays and Processing

Digital Operator Display	Description	Cause	Corrective Action
CPF04 Internal A/D Err	CPU Internal A/D Converter Fault	Noise or spike on the control circuit input terminals	Perform a factory initialization
			Cycle power off and on to the Drive
			Replace the control board
CPF05 External A/D Err	CPU External A/D Converter Fault	Noise or spike on the control circuit input terminals	Perform a factory initialization
			Cycle power off and on to the Drive
			Replace the control board
CPF07 RAM-Err	ASIC Internal RAM Fault (RAM)	---	Cycle power off and on to the Drive
		Control circuit damage	Replace the Drive
CPF08 WAT-Err	Watchdog Timer Fault (WAT)	---	Cycle power off and on to the Drive
		Control circuit damage	Replace the Drive
CPF09 CPU-Err	CPU-ASIC Mutual Diagnosis Fault (COY)	---	Cycle power off and on to the Drive
		Control circuit damage	Replace the Drive
CPF10 ASIC-Err	ASIC Version Fault (ASIC)	Control circuit damage	Replace the Drive
CPF20 Option A/D Error	Option Card Fault	Option card connector connection fault	Remove all inputs to the option board
		Option card A/D converter fault	Perform a factory initialization
			Cycle power off and on to the Drive
			Replace the option board
CPF21 Option CPU Down	Self-diagnosis Fault of Communication Option Card	Noise or spike on the communication line, defective option board	Replace the Control board
			Perform a factory initialization
			Cycle power off and on to the Drive
			Replace the option board
CPF22 Option Type Err	Communication Option Card Code Number Fault	Unrecognizable option board is connected to the control board	Remove any option boards
			Cycle power off and on to the Drive
			Perform a factory initialization
			Replace the option board
			Replace the control board

Table 6.1 Fault Displays and Processing

Digital Operator Display	Description	Cause	Corrective Action	
CPF23 Option DPRAM Err	Communication Option Card Interconnection Fault	An option board is not correctly connected to the control board or an option board that is not made for the Drive is attached to the control board	Remove power to the Drive	
			Connect the option board once more	
			Perform a factory initialization	
			Cycle power off and on to the Drive	
			Replace the option board	
			Replace the control board	
EF0 Opt External Flt	Communication Option Card External Fault	An external fault condition exists	Check for an external condition	
			Verify the parameters	
			Verify communication signal	
EF3 Ext Fault S3	External Fault at Terminal S3	An external fault condition exists connected to a multi-function digital input	Eliminate the cause of an external fault condition	
EF4 Ext Fault S4	External Fault at Terminal S4			
EF5 Ext Fault S5	External Fault at Terminal S5			
EF6 Ext Fault S6	External Fault at Terminal S6			
EF7 Ext Fault S7	External Fault at Terminal S7			Remove the fault from a multi-function digital input
FBL Feedback Loss	PI Feedback Loss This fault occurs when PI Feedback Loss Detection is programmed to fault (b5-12 = 2) and the PI Feedback < PI Feedback Loss Detection Level (b5-13) for the PI Feedback Loss Detection Time (b5-14)			PI Feedback source (e.g. transducer, sensor, building automation signal) is not installed correctly or is not working
			Check to ensure the PI Feedback source is installed and working properly	
GF Ground Fault	Output Ground Fault Drive output grounding current has exceeded 50% of the Drive rated output current	Motor lead is shorted to ground, DCCT defective	Remove the motor and run the Drive without the motor	
			Check the motor for a phase to ground short.	
			Check the output current with a clamp on meter to verify the DCCT reading	
LF Ouput Pha Loss	Output Phase Loss Drive output has an open phase or the motor no load current is below the setting of parameter E2-03	Open phase on the output of the drive	Check output voltage	
		Loose terminal screws at T1, T2 or T3	Tighten the terminal screws	
		Parameter E2-03 set incorrectly	Adjust E2-03 to a lower value	

Table 6.1 Fault Displays and Processing

Digital Operator Display	Description	Cause	Corrective Action
LL3 Loss of Load Det 1	Loss of Load Detection 1 Drive output current < L6-02 for more than the time set in L6-03	Motor is underloaded	Ensure the values in L6-02 and L6-03 are appropriate
			Check application/machine status to eliminate fault
OC Over Current	Overcurrent Drive output current exceeded the overcurrent detection level (approximately 180% of Drive rated output current)	Shorted Drive output phase to phase, shorted motor, locked rotor, load too heavy, accel/ decel time too short, contactor on the Drive output is opened and closed, a special motor or a motor with a FLA rating larger than Drive rated output current	Remove the motor and run the Drive without the motor
			Check the motor for a phase-to-phase short
			Check the Drive for a phase-to-phase short at the output
			Verify C1-01 and C1-02 are set correctly
OH1 Heatsnk MAX Temp	Cooling Fin/Cooling Fin Fan Overheat The temperature of the Drive cooling fin exceeded the temperature programmed in parameter L8-02, and L8-03=0-2	Cooling fan(s) are not working, high ambient temperature, a heat source is too close to the Drive	Check for dirt build-up on the fans and cooling fins
			Reduce the ambient temperature around the Drive
	Drive Internal Cooling Fan		Remove the heating unit/Replace the cooling fan
OH3 Motor Overheat 1	Motor Overheating Alarm The Drive stops or continues operation according to the setting of L1-03.	Overheating of motor as measured by motor thermistor	Recheck the cycle time and the size of the load
			Recheck the accel/decel time (C1-01 and C1-02)
			Recheck the V/F pattern (E1-01 thru E1-13)
			Recheck the motor rated current value (E2-01)
OH4 Motor Overheat 2	Motor Overheating Fault The Drive stops operation according to the setting of L1-04.	Overheating of motor as measured by motor thermistor	Recheck the cycle time and the size of the load
			Recheck the accel/decel time (C1-01 and C1-02)
			Recheck the V/F pattern (E1-01 thru E1-13)
			Recheck the motor rated current value (E2-01)
OL1 Motor Overloaded	Motor Overload Designed to protect the motor. Fully adjustable from parameter E2-01	The load is too large. The cycle time is too short at the accel/decel time	Recheck the cycle time and the size of the load as well as the times set in C1-01 and C1-02
		The voltage of the V/F pattern is high	Review the V/F pattern parameters, E1-01 thru E1-13
		Motor rated current setting is improper	Check the motor rated current value in E2-01

Table 6.1 Fault Displays and Processing

Digital Operator Display	Description	Cause	Corrective Action
OL2 Inv Overloaded	Drive Overload Designed to protect the Drive	The load is too large. The cycle time is too short at the accel/decel time	Recheck the cycle time and the size of the load as well as the times set in C1-01 and C1-02
		The voltage of the V/F pattern is high	Review the V/F pattern parameters, E1-01 thru E1-13
		The size of the Drive is small	Change to a larger size Drive
OL3 Overtorque Det 1	Overtorque Detection 1 Drive output current > L6-02 for more than the time set in L6-03	Motor is overloaded	Ensure the values in L6-02 and L6-03 are appropriate
			Check application/machine status to eliminate fault
OPR Oper Disconnect	Digital Operator Connection Fault The Drive will stop if the digital operator is removed when the Drive is commanded to run through the digital operator	The digital operator is not attached or the digital operator connector is broken	Attach the digital operator
			Check the digital operator connector
			Verify the setting of o2-06
OV DC Bus Overvolt	DC Bus Overvoltage 208-240Vac: Trip point is $\geq 400Vdc$ 480Vac: Trip point is $\geq 800Vdc$	High input voltage at R/L1, S/L2 and T/L3	Check the input circuit and reduce the input power to within specifications
		The deceleration time is set too short	Extend the time in C1-02
		Power factor correction capacitors are being used on the input to the Drive	Remove the power factor correction capacitors
PF Input Pha Loss	Input Phase Loss Drive input power supply has an open phase or has a large imbalance of input voltage	Open phase on the input of the Drive	Check the input voltage
		Loose terminal screws at R/L1, S/L2 or T/L3.	Tighten the terminal screws
		Momentary power loss occurred	Check the input voltage
		Input voltage fluctuation too large	Check the input voltage
		Parameter L8-06 value is set incorrectly	Adjust L8-06 according to your application. The higher the value the less sensitive it becomes.
PUF DC Bus Fuse Open	DC Bus Fuse Detects if the DC bus fuse has opened	Shorted output transistor(s) or terminals	Remove power from the Drive
			Disconnect the motor
			Perform the checks without power in Table 6.6
			Replace the shorted component(s)
			Replace the defective fuse

Table 6.1 Fault Displays and Processing

Digital Operator Display	Description	Cause	Corrective Action
RH DynBrk Resistor	Dynamic Braking Resistor The protection of the dynamic braking resistor based on setting of L8-01	Overhauling load, extended dynamic braking duty cycle, defective dynamic braking resistor	Verify dynamic braking duty cycle
			Monitor DC bus voltage
			Replace dynamic braking resistor
RR DynBrk Transistr	Dynamic Braking Transistor The dynamic braking transistor failed	Shorted dynamic braking transistor, high DC bus voltage, defective dynamic braking resistor	Cycle power off and on to the Drive
			Replace defective dynamic braking transistor or resistor
			Monitor DC bus voltage
UV1 DC Bus Undervolt	DC Bus Undervoltage The DC bus voltage is $\leq$ L2-05 208-240Vac: Trip point is $\leq$ 190Vdc 480Vac: Trip point is $\leq$ 380Vdc	Low input voltage at R/L1, S/L2 and T/L3	Check the input circuit and increase the input power to within specifications
		The acceleration time is set too short	Extend the time in C1-01
		Voltage fluctuation of the input power is too large	Check the input voltage
UV2 CTL PS Undervolt	Control Power Supply Undervoltage Undervoltage of the control circuit when running	External load connected pulling down the Drive power supplies	Cycle power off and on to the Drive
			Repair or replace the Power PCB/ Gate Drive PCB
			Remove all control wiring and test Drive
UV3 MC Answerback	Soft Charge Circuit Fault The pre-charge contactor opened while the Drive was running	Contacts on the soft charge contactor are dirty and the soft charge contactor does not function mechanically	Cycle power off and on to the Drive
			Check the condition of the soft charge contactor
			Repair or replace the Power PCB/ Gate Drive PCB

**WARNING**

Some features within the PI function group cause the Drive to shut down momentarily (e.g. Sleep Function, Snooze Function, Feedback Loss feature etc.) Upon recovery from the conditions that activate these features, the Drive may start unexpectedly. Therefore, when enabling these features take appropriate measures to notify personnel working with this equipment that unexpected starting may occur.

# Alarm Detection

Alarms are Drive protection functions that does not operate the fault contact. The Drive will automatically return to its original status once the cause of the alarm has been removed.

During an alarm condition, the Digital Operator display flashes and an alarm output is generated at the multi-function outputs (H2-01 to H2-02) if programmed.

When an alarm occurs, take appropriate corrective action according to the table below.

Table 6.2 Alarm Displays and Processing			
Digital Operator Display	Description	Cause	Corrective Action
BUS Option Com Err	Option Communication Error After initial communication was established, the connection was lost.	Connection is broken, master has stopped communicating	Check all connections, verify all user side software configurations.
CALL SI-F/G ComCall	Serial communication transmission error. Communication has not yet been established	Connection not made properly, user software not configured to the proper baud rate or configuration	Check all connections, verify all user side software configurations
EF External Fault	Both the forward and the reverse run commands are input simultaneously for 500mS or more. This alarm stops the motor.	An external forward and reverse command are input simultaneously	Check external sequence logic
EF0 Opt External Flt (Flashing)	Communication Option Card External Fault	An external fault condition exists	Check for an external condition
			Verify the parameters
			Verify communication signal
EF3 Ext Fault S3 (Flashing)	External Fault at Terminal S3	An external fault condition exists connected to a multi-function digital input	Eliminate the cause of an external fault condition
EF4 Ext Fault S4 (Flashing)	External Fault at Terminal S4		
EF5 Ext Fault S5 (Flashing)	External Fault at Terminal S5		
EF6 Ext Fault S6 (Flashing)	External Fault at Terminal S6		
EF7 Ext Fault S7 (Flashing)	External Fault at Terminal S7		
DNE Drive not Enable (Flashing)	The Drive does not have the enable command when the run command is applied	The Run command has been applied prior to the enable signal	Apply the enable command before applying the run command

Table 6.2 Alarm Displays and Processing

Digital Operator Display	Description	Cause	Corrective Action
FAN Cooling Fan Error	Failure of the Drive internal cooling fan when L8-32=0	Drive cooling fan has stopped	Replace the cooling fan
FBL Feedback Loss	PI Feedback Loss This fault occurs when PI Feedback Loss Detection is programmed to fault (b5-12 = 2) and the PI Feedback < PI Feedback Loss Detection Level (b5-13) for the PI Feedback Loss Detection Time (b5-14)	PI Feedback source (e.g. transducer, sensor, building automation signal) is not installed correctly or is not working	Verify Drive is programmed to receive the PI Feedback source signal Check to ensure the PI Feedback source is installed and working properly Check the motor for a phase-to-phase short Check the Drive for a phase-to-phase short at the output Verify C1-01 and C1-02 are set correctly Check load conditions
LL3 Loss of Load Det 1 (Flashing)	Loss of Load Detection 1 Drive output current < L6-02 for more than the time set in L6-03	Motor is underloaded	Ensure the values in L6-02 and L6-03 are appropriate Check application/machine status to eliminate fault
OH Heatsnk Overtemp (Flashing)	Cooling Fin/Cooling Fin Fan Overheat The temperature of the Drive cooling fin exceeded the temperature programmed in parameter L8-02	Cooling fan(s) are not working, high ambient temperature, a heating unit in close proximity to Drive is present	Check for dirt build-up on the fans and cooling fins Reduce the ambient temperature around the Drive
	Drive Internal Cooling Fan		Remove the heating unit
OH2 Over Heat 2 (Flashing)	Drive overheat pre-alarm signal is input from a multi-function digital input terminal	An external overheat condition exists connected to one of the multi-function input terminals S3, S4, S5, S6 or S7	Check for an external condition Verify the program parameters H1-01 thru H1-05
OH3 Motor Overheat 1 (Flashing)	Motor Overheating Alarm The Drive stops or continues operation according to the setting of L1-03.	Overheating of motor	Recheck the cycle time and the size of the load Recheck the accel/decel time (C1-01 and C1-02) Recheck the V/F pattern (E1-01 thru E1-13) Recheck the motor rated current value (E2-01) Check the digital operator connector Verify the setting of o2-06

Table 6.2 Alarm Displays and Processing

Digital Operator Display	Description	Cause	Corrective Action
OV DC Bus Overvolt (Flashing)	DC Bus Overvoltage 208-240Vac: Trip point is $\geq 400Vdc$ 480Vac: Trip point is $\geq 800Vdc$	High input voltage at R/L1, S/L2 and T/L3	Check the input circuit and reduce the input power to within specifications
		The deceleration time is set too short	Extend the time in C1-02
		Power factor correction capacitors are being used on the input to the Drive	Remove the power factor correction capacitors
OVRD Emergency Override	Emergency Override Emergency Override is active	Forward or Reverse Emergency Override input is closed	---
PRHT Motor Preheating	Motor Preheating Motor is preheating	Motor Preheat 2 input is closed	---
UV DC Bus Undervolt (Flashing)	DC Bus Undervoltage The DC bus voltage is $\leq L2-05$ 208-240Vac: Trip point is $\leq 190Vdc$ 480Vac: Trip point is $\leq 380Vdc$	Low input voltage at R/L1, S/L2 and T/L3	Check the input circuit and increase the input power to within specifications
		The acceleration time is set too short	Extend the time in C1-01
		Voltage fluctuation of the input power is too large	Check the input voltage
UV2 CTL PS Undervolt	Control Power Supply Undervoltage of the control circuit when running	External load connected pulling down the Drive power supplies	Cycle power off and on to the Drive
			Repair or replace the Power PCB/Gate Drive PCB
UV3 MC Answerback	Soft Charge Circuit Fault The pre-charge contactor opened while the Drive was running	Contacts on the soft charge contactor are dirty and the soft charge contactor does not function mechanically	Cycle power off and on to the Drive
			Check the condition of the soft charge contactor

# Operator Programming Errors (OPE)

An Operator Programming Error (OPE) occurs when an inapplicable parameter is set or an individual parameter setting is inappropriate.

The Drive does not operate until the parameter is set correctly. (Alarm output and fault contact do not operate.)

If an OPE occurs, change the appropriate parameter by checking the cause shown in Table 6.3.

Table 6.3 OPE Error and Fault Displays			
Digital Operator Display	Description	Cause	Corrective Action
OPE01 kVA Selection t	Drive kVA setting error.	The control board was replaced and the kVA parameter is set incorrectly	Enter the correct kVA setting (o2-04) by referring to the Drive model number in Appendix B
OPE02 Limit	Constant data out of range.	Parameter set above the allowable range.	Verify the program settings
OPE03 Terminal	Multi-function input selection fault.	Duplicate functions are selected, up/down commands or trim control increase/decrease are not set simultaneously. Speed search from maximum frequency and set frequency are set simultaneously.	Verify program settings (H1-01~H1-05)
OPE05 Sequence Select	Run command is selected through serial communication at 2CN but option board is not installed.	Serial communication option board is not installed, option board is installed incorrectly. The run command selection parameter B1-02 is set to 3 and option board is not installed.	Verify that the board is installed. Remove power to the Drive and connect the option board once more.
OPE10 V/f Ptrn Setting	V/f data setting fault	V/f parameter settings are not set correctly.	Check parameters (E1-04 ~ E1-11). A minimum frequency/voltage value may be set higher than the maximum frequency/voltage.
OPE11 CarrFrq/On-Delay	Carrier frequency data setting fault. Carrier frequency proportional gain C6-05 > 6 and C6-04 > C6-03. Upper/lower limit error of C6-03 to 5.0kHz	Parameter setting incorrect.	Check the program settings and correct the errors.
ERR EEPROM R/W Err	It does not match at EEPROM write.	<ul style="list-style-type: none"> <li>Power supply is turned OFF.</li> <li>Parameter is reset repeatedly.</li> </ul>	<ul style="list-style-type: none"> <li>Cycle power off and on to Drive.</li> <li>Do a factory initialization (A1-03).</li> </ul>

# Auto-Tuning Faults

Auto-tuning faults are shown below. When the following faults are detected, the fault is displayed on the digital operator and the motor coasts to a stop during operation. The fault contact is not activated.

Digital Operator Display	Probable Cause	Corrective Action
Er - 01 Fault	<ul style="list-style-type: none"> <li>•There is an error in the data input for autotuning.</li> <li>•There is an error in the relationship between the motor output and the motor rated current.</li> </ul>	<ul style="list-style-type: none"> <li>• Check input data.</li> <li>• Check Drive and motor capacity.</li> <li>• Check motor rated current.</li> </ul>
Er - 02 Minor Fault	A minor fault is detected during auto-tuning.	<ul style="list-style-type: none"> <li>• Check input data.</li> <li>• Check wirings and around the machine.</li> <li>• Check the load.</li> </ul>
Er - 03 STOP key	The STOP key is pressed during auto-tuning, and the auto-tuning is interrupted.	–
Er - 04 Resistance	Auto-tuning is not completed within the specified time. The auto-tuning result became other than the parameter set range.	<ul style="list-style-type: none"> <li>• Check input data.</li> <li>• Check motor wiring.</li> <li>• If a motor and a machine are connected, disconnect the motor from the machine.</li> </ul>
Er - 12 I-det. Circuit	<ul style="list-style-type: none"> <li>•Current flow exceeded the motor rated current.</li> <li>•Current detection value symbol was reversed.</li> <li>•Any of U/T1, V/T2, and W/T3 has open-phase.</li> </ul>	<ul style="list-style-type: none"> <li>• Check current detection circuit, wiring and mounting procedure.</li> </ul>
Er - 13 Leakage Inductance Fault	Auto-tuning did not finish within the set time. Tuning result became other than the parameter setting range.	<ul style="list-style-type: none"> <li>• Check motor wiring.</li> </ul>
End - 3 Data Invalid	Rated current set value is set too high.	<ul style="list-style-type: none"> <li>• Check input data (especially, motor output current and motor rated current value).</li> </ul>

# Digital Operator COPY Function Faults

These faults can occur occurred during the operator COPY function. Fault content is displayed on the operator. An error during the COPY function does not activate the fault contact output or alarm output.

Table 6.5 Digital Operator COPY Function Faults

Function	Digital Operator Display	Probable Causes	Corrective Action
READ Function	PRE READ IMPOSSIBLE	o3-01 was set to 1 to write a parameter when the Digital Operator was write-protected (o3-02 = 0).	Set o3-02 to 1 to enable writing parameters with the Digital Operator.
	IFE READ DATA ERROR	The read data length does not agree. The write data is incorrect.	<ul style="list-style-type: none"> <li>• Repeat the Read.</li> <li>• Check the Digital Operator cable.</li> <li>• Replace digital operator.</li> </ul>
	RDE DATA ERROR	An attempted write of a parameter to EEPROM on the Digital Operator failed.	<ul style="list-style-type: none"> <li>• A low Inverter voltage has been detected.</li> <li>• Repeat the read</li> <li>• Replace Digital Operator.</li> </ul>
COPY Function	CPE ID UNMATCHED	The Drive product code or software number is different.	Use COPY function for the same product code and software number.
	VAE INV. KVA UNMATCH	The capacity of the Drive being copied and the capacity in the Digital Operator are different.	Use COPY function for the same Drive capacity.
	CRE CONTROL UNMATCHED	The control method of the Drive being copied and the control method in the Digital Operator are different.	Use the COPY function for the same control method.
	CYE COPY ERROR	The parameter written to the Drive was compared with the parameter in the Digital Operator and they were different.	COPY retest
	CSE SUM CHECK ERROR	The checksum in the Drive parameter area was compared with the checksum in the Digital Operator parameter area and they were different.	Retry the copy.
Verify Function	VYE VERIFY ERROR	The set value of the digital operator and the Drive do not match.	Retry Verify function After COPY is retested, Verify is retested

# Troubleshooting

Due to parameter setting errors, faulty wiring, etc., the Drive and motor may not operate as expected when the system is started up. If this occurs, use this section as a reference and apply the appropriate measures.

If a fault is displayed on the digital operator, refer to Fault Detection, Table 6.1.

---

## ◆ If Parameter Cannot Be Set

Use the following information if a Drive parameter cannot be set.

### ■ The display does not change when the INCREASE and DECREASE keys are pressed.

The following causes are possible.

#### The Drive is operating (drive mode).

There are some parameters that cannot be set during operation. Remove the run command and then set the parameters.

#### Parameter write enable is input.

This occurs when "parameter write enable" (set value: 1B) is set for a multi-function digital input terminal (H1-01 to H1-05). If the parameter write enable input is OFF, the parameters cannot be changed. Turn it ON and then set the parameters.

#### Passwords do not match. (Only when a password is set.)

If the parameter A1-04 (Password) and A1-05 (Password Setting) numbers are different, the parameters for the initialize mode cannot be changed. Enter the correct password in A1-04.

If you cannot remember the password, display A1-05 (Password Setting) by pressing the Shift/Reset Key and the MENU Key simultaneously while in the A1-04 display. Reset the password and input the reset password in parameter A1-04.

### ■ OPE01 through OPE11 is displayed.

The set value for the parameter is wrong. Refer to Operator Programming Errors in this chapter and correct the setting.

### ■ CPF00 or CPF01 is displayed.

This is a Digital Operator communications error. The connection between the Digital Operator and the Drive may be faulty. Remove the Digital Operator and then re-install it.

---

## ◆ If the Motor Does Not Operate

Use the following information if the motor does not operate.

### ■ Ensure the digital operator is securely connected to the Drive.

### ■ The motor does not operate when the HAND key on the Digital Operator is pressed.

The following causes are possible:

#### **The Speed Command (Frequency Reference) is too low.**

If the Speed Command (frequency reference) is set below the frequency set in E1-09 (Minimum Output Frequency), the Drive will not operate.

Raise the Speed Command to at least the minimum output frequency.

### ■ The motor does not operate when an external run command is input.

The following causes are possible.

#### **The Drive is not in drive mode.**

If the Drive is not in drive mode, it will remain in ready status and will not start. Press the MENU key once and press the DATA/ENTER key. The Drive is now in drive mode.

#### **The Speed Command is too low.**

If the Speed Command is set below the frequency set in E1-09 (Minimum Output Frequency), the Drive will not operate. Raise the Speed Command to at least the minimum output frequency.

■ **The motor stops during acceleration or when a load is connected.**

The load may be too high. The Drive has a stall prevention function and an automatic torque boost function, but the motor responsiveness limit may be exceeded if acceleration is too rapid or if the load is too great. Lengthen the acceleration time (CI-01) or reduce the load. Also consider increasing the motor size.

■ **The motor only rotates in one direction.**

"Reverse run prohibited" may be selected. If b1-04 (Prohibition of Reverse Operation) is set to 1 (reverse run prohibited), the Drive will not receive reverse run commands. This is the default to use both forward and reverse operation, set b1-04 to 0, and operate in Auto mode.

---

◆ **The Direction of the Motor Rotation is Reversed**

If the motor rotates in the wrong direction, the motor output wiring is incorrect. When the Drive U/T1, V/T2, and W/T3 terminals are properly connected to the motor, the motor operates in a forward direction when a forward run command is received. The forward direction depends on the manufacturer and the motor type, so be sure to check the specifications.

The direction of rotation can be reversed by switching any two wires among U/T1, V/T2, and W/T3.

---

◆ **If the Motor Does Not Put Out Torque or If Acceleration is Slow**

Use the following information if the motor does not output torque or if acceleration is too slow.

■ **The stall prevention level during acceleration is too low.**

If the value set for L3-02 (Stall Prevention Acceleration Level) is too low, the acceleration time will be too long. Check to be sure that the set value is suitable.

■ **The stall prevention level during running is too low.**

If the value set for L3-06 (Stall Prevention Level during Running) is too low, the motor speed and torque will be limited. Check to be sure that the set value is suitable.

---

◆ **If the Motor Operates at a Higher Speed Than the Speed Command**

Use the following information if the motor operates at a higher speed than the Speed Command.

■ **A signal is being input to the Speed Command (current) terminal A2.**

If a preset frequency reference is selected, the preset reference takes priority over the normal reference.

If the PI mode of operation is enabled, the drive output frequency will change to regulate the process variable to the desired setpoint. Then, the Drive speed may go to maximum.

---

## ◆ If the Motor Overheats

Take the following steps if the motor overheats.

### ■The load is too high.

If the motor load is too high and the motor is used when the effective torque exceeds the motor's rated torque, the motor will overheat. Reduce the load amount by either reducing the load or increasing the acceleration/deceleration times. Also consider increasing the motor size.

### ■The ambient temperature is too high.

The motor rating is determined by a particular ambient operating temperature range. The motor will overheat if it is run continuously at the rated torque in an environment where the maximum ambient operating temperature rating is exceeded. Lower the motor's ambient temperature to within its acceptable range.

### ■The withstand voltage between the motor phases is insufficient.

When the motor is connected to the Drive output, Voltage surges are generated by standing waves that can occur with certain combinations of drive carrier frequency and motor cable length. Normally the maximum surge voltage is three times the Drive's input power supply voltage (i.e., 1200Vac for a 480Vac). Be sure to use a motor with a withstand voltage between the motor phases that is greater than the maximum surge voltage. In particular, when using a 480Vac Drive, use an inverter-duty (NEMA MG1, Parts 30 & 31) motor. Motor protection filter can also be an effective measure.

---

## ◆ If Peripheral Devices Like DDCs or Others are Influenced by Starting or Running Drive

If noise is generated by Drive switching, implement the following countermeasures:

1. Change the Drive's Carrier Frequency Selection (C6-02) to lower the carrier frequency. This will help to reduce the amount of internal switching.
2. Install an Input Noise Filter at the Drive's input power terminals.
3. Use metal conduit. Electric waves can be shielded by metal, so encase the Drive and power wires in metal.
4. Ground the Drive and motor.
5. Separate main circuit wiring from control wiring.

---

## ◆ If a “Stand-alone” Ground Fault Interrupter Operates When the Drive is Run

The Drive performs internal switching, so there is a certain amount of leakage current. This may cause an external ground fault interrupter to operate and cut off the power supply. Whenever possible, use a ground fault interrupter with a high leakage detection level (i.e., a sensitivity current of 200 mA or greater per Unit, with an operating time of 0.1 s or more), or one that incorporates high frequency countermeasures (i.e., one designed for use with Drives). It will also help to change the Drive's Carrier Frequency Selection (C6-02) to lower the carrier frequency. In addition, remember that the leakage current increases as the cable is lengthened.

---

## ◆ If There is Mechanical Vibration

Use the following information when there is mechanical vibration.

### ■ The application is making unusual sounds.

The following causes are possible.

#### **There may be resonance between the mechanical system's natural frequency and the carrier frequency.**

This is characterized by the motor running with no noise generation, but the machinery vibrates with a high-pitched whine. To prevent this type of resonance, adjust the carrier frequency with parameters C6-02 to C6-05.

#### **There may be resonance between an applications characteristic frequency and the output frequency of the Drive.**

To prevent this from occurring, use the jump frequency functions in parameters d3-01 to d3-04, or have the driven motor and load balanced to reduce vibration.

### ■ Oscillation and hunting are occurring with V/f control.

The gain adjustment may be insufficient. Reset the gain to a more effective level by raising the value of C4-02 (Torque Compensation Primary Delay Time Parameter) and then lowering the setting of n1-02 (Hunting Prevention Gain).

### ■ Oscillation and hunting are occurring with PI control.

If there is oscillation or hunting during PI control, check the oscillation cycle and individually adjust P and I parameters.

- Disable integral (I) control
- Reduce the proportional gain (P) until hunting stops
- Reintroduce the integral function, starting with long integral time values, to eliminate the P offset

---

## ◆ If the Motor Rotates Even When Drive Output is Stopped

If the motor rotates even when the Drive is stopped, the DC injection braking may be insufficient. If the motor continues operating at low speed, without completely stopping after a stop has been executed, it means that the DC injection braking is not decelerating the motor enough. Adjust the DC injection braking as follows:

- Increase the parameter b2-04 (DC Injection Braking (initial excitation) Time at Stop) setting.
- Increase the parameter b2-02 (DC Injection Braking Current) setting.

---

## ◆ If Zero Volts is Detected When a Motor is Started, or Stalls

Generation of 0 V (main circuit voltage) and stalling can occur if a motor is turning when it is started and the DC injection braking is insufficient.

This can be prevented by slowing motor rotation by DC injection braking before starting. Increase parameter b2-03 (DC injection braking time at start) setting.

---

## ◆ If the Accepted Speed Command Does Not Rise to the User Speed Command Input

### ■ The Speed Command is within the jump frequency range.

When the jump frequency function is used, the output frequency cannot be set within the jump frequency range. Check to be sure that the Jump Frequency (parameters d3-01 to d3-03) and Jump Frequency Width (parameter d3-04) settings are suitable.

### ■ The frequency reference upper limit has been reached.

The output frequency upper limit is determined by the following formula:

$$\text{Freq Ref Upper Limit} = \text{Maximum Output Frequency (E1-04)} \times \text{Frequency Reference Upper Limit (d2-01)} / 100$$

Check to be sure that the parameter E1-04 and d2-01 settings are suitable.

# Main Circuit Test Procedure

## WARNING

Prior to removing any protective cover or wiring any part of the Drive, remove all power sources, including main input power and control circuit power. Wait a minimum of 5 minutes after power removal, before removing any cover. The charge lamp located within the Drive should be off prior to working inside. Even if the charge lamp is off, one must measure the AC input, output, and DC Bus potential to insure safe levels prior to resuming work. Failure to adhere to this warning may result in personal injury or death.

Before attempting any troubleshooting checks, make sure that the three-phase power is disconnected and locked out. With power removed from the unit, the DC bus capacitors will stay charged for several minutes. The Charge LED in the Drive will glow red until the DC bus voltage is below 10Vdc. To ensure that the DC bus is completely discharged, measure between the positive and negative bus with a DC voltmeter set to the highest scale.

Check	Procedure
Measure DC Bus Voltage	<ol style="list-style-type: none"> <li>1. Set the digital multi-meter to its highest VDC scale.</li> <li>2. Measure between ⊕ 1 and (-) for the following check: Place the positive (red) meter lead on ⊕ 1. Place the negative (black) meter lead on (-).</li> <li>3. If the measured voltage is &lt; 10Vdc, it is safe to work inside the Drive. If not, wait until the DC Bus has completely discharged.</li> </ol>
Input Diodes (D1-D12 or Q1)	<p>The input diodes rectify or transform the three-phase input AC voltage into a DC voltage.</p> <ol style="list-style-type: none"> <li>1. Set a digital multi-meter to the Diode Check setting.</li> <li>2. Place the positive (red) meter lead on terminal R/L1. Place the negative (black) meter lead on terminal ⊕ 1. Expected reading is about 0.5 Volts.</li> <li>3. Place the positive (red) meter lead on terminal S/L2. Place the negative (black) meter lead on terminal ⊕ 1. Expected reading is about 0.5 Volts.</li> <li>4. Place the positive (red) meter lead on terminal T/L3. Place the negative (black) meter lead on terminal ⊕ 1. Expected reading is about 0.5 Volts.</li> <li>5. Place the positive (red) meter lead on terminal R/L1. Place the negative (black) meter lead on terminal (-). Expected reading is OL displayed.</li> <li>6. Place the positive (red) meter lead on terminal S/L2. Place the negative (black) meter lead on terminal (-). Expected reading is OL displayed.</li> <li>7. Place the positive (red) meter lead on terminal T/L3. Place the negative (black) meter lead on terminal (-). Expected reading is OL displayed.</li> <li>8. Place the positive (red) meter lead on terminal (-). Place the negative (black) meter lead on terminal R/L1. Expected reading is about 0.5 Volts.</li> <li>9. Place the positive (red) meter lead on terminal (-). Place the negative (black) meter lead on terminal S/L2. Expected reading is about 0.5 Volts.</li> <li>10. Place the positive (red) meter lead on terminal (-). Place the negative (black) meter lead on terminal T/L3. Expected reading is about 0.5 Volts.</li> </ol> <p style="text-align: right;">(Continued on next page)</p>

Table 6.6 Main Circuit Test Procedure

Check	Procedure
<p>Input Diodes (D1-D12 or Q1)</p>	<p align="center"><b>(Continued from previous page)</b></p> <ol style="list-style-type: none"> <li>11. Place the positive (red) meter lead on terminal ⊕ 1. Place the negative (black) meter lead on terminal R/L1. Expected reading is OL displayed.</li> <li>12. Place the positive (red) meter lead on terminal ⊕ 1. Place the negative (black) meter lead on terminal S/L2. Expected reading is OL displayed.</li> <li>13. Place the positive (red) meter lead on terminal ⊕ 1. Place the negative (black) meter lead on terminal T/L3. Expected reading is OL displayed.</li> </ol>
<p>Soft Charge Resistor Check (R1, R2, 6PCB)</p>	<p>The soft charge resistor works in conjunction with the soft charge contactor to slowly charge the DC bus capacitors to minimize the inrush current when power is applied to the Drive.</p> <ol style="list-style-type: none"> <li>1. Conduct a visual inspection. Check for physical damage.</li> <li>2. Set a digital multi-meter to the R x 1 scale.</li> <li>3. If the resistor is damaged, the measured value will be infinite ohms.</li> </ol>
<p>Soft Charge Contactor (K1)</p>	<p>The purpose of the soft charge contactor is to bypass the soft charge resistor after the DC bus voltage has reached its normal operating level.</p> <ol style="list-style-type: none"> <li>1. Conduct a visual inspection. Check for physical damage.</li> <li>2. Set a digital multi-meter to the R x 1 scale.</li> <li>3. On Drives with a board-mounted contactor, verify that each contact resistance measures infinite ohms.</li> <li>4. On Drives without a board-mounted contactor, press the plunger in, and verify that each contact measures zero ohms.</li> <li>5. On Drives without a board-mounted contactor, release the plunger, and verify that the resistance is the ohmic value of the soft charge resistor.</li> <li>6. On Drives with a board-mounted contactor, verify that the contactor coil measures about 300 ohms. The coil can be tested by applying the appropriate voltage to verify the contacts change states.</li> <li>7. On Drives without a board-mounted contactor, verify that the 230Vac contactor coil measures about 175 ohms. The coil can be tested by applying the appropriate voltage to verify the contacts change states.</li> <li>8. On Drives without a board-mounted contactor, verify that the 24Vdc auxiliary coil measures about 2.2M ohms. The coil can be tested by applying the appropriate voltage to verify the contacts change states.</li> </ol>
<p>DC Bus Fuse (F1)</p>	<p>The DC bus fuse is located in the negative portion of the DC Bus. The DC bus fuse is used to protect the main circuit components if the output transistors short. If the DC bus fuse is open, at least one of the output transistors has failed. When a transistor fails, there is a short between the positive and negative portions of the DC Bus. The DC bus fuse does not protect the transistors, but protects the rest of the main circuit from the high current present during a short. <b><i>Never replace the DC bus fuse without first checking all of the output transistors.</i></b></p> <ol style="list-style-type: none"> <li>1. Set a digital multi-meter to the R x 1 scale.</li> <li>2. Place one lead of the multi-meter on one side of the fuse and place the other lead of the multi-meter on the other side of the fuse.</li> <li>3. If the fuse is good, the measured value will be zero ohms. If the fuse is bad, the measured value will be infinite ohms.</li> </ol>

Table 6.6 Main Circuit Test Procedure

Check	Procedure
<p>Output Transistors (Q1-Q12)</p>	<p>The output transistors are used to switch the DC bus voltage to allow current to flow to the motor.</p> <ol style="list-style-type: none"> <li>1. Set a digital multi-meter to the Diode Check setting.</li> <li>2. Place the positive (red) meter lead on terminal U/T1. Place the negative (black) meter lead on terminal ⊕ 1. Expected reading is about 0.5 Volts.</li> <li>3. Place the positive (red) meter lead on terminal V/T2. Place the negative (black) meter lead on terminal ⊕ 1. Expected reading is about 0.5 Volts.</li> <li>4. Place the positive (red) meter lead on terminal W/T3. Place the negative (black) meter lead on terminal ⊕ 1. Expected reading is about 0.5 Volts.</li> <li>5. Place the positive (red) meter lead on terminal U/T1. Place the negative (black) meter lead on terminal (-). Expected reading is OL displayed.</li> <li>6. Place the positive (red) meter lead on terminal V/T2. Place the negative (black) meter lead on terminal (-). Expected reading is OL displayed.</li> <li>7. Place the positive (red) meter lead on terminal W/T3. Place the negative (black) meter lead on terminal (-). Expected reading is OL displayed.</li> <li>8. Place the positive (red) meter lead on terminal (-). Place the negative (black) meter lead on terminal U/T1. Expected reading is about 0.5 Volts.</li> <li>9. Place the positive (red) meter lead on terminal (-). Place the negative (black) meter lead on terminal V/T2. Expected reading is about 0.5 Volts.</li> <li>10. Place the positive (red) meter lead on terminal (-). Place the negative (black) meter lead on terminal W/T3. Expected reading is about 0.5 Volts.</li> <li>11. Place the positive (red) meter lead on terminal ⊕ 1. Place the negative (black) meter lead on terminal U/T1. Expected reading is OL displayed.</li> <li>12. Place the positive (red) meter lead on terminal ⊕ 1. Place the negative (black) meter lead on terminal V/T2. Expected reading is OL displayed.</li> <li>13. Place the positive (red) meter lead on terminal ⊕ 1. Place the negative (black) meter lead on terminal W/T3. Expected reading is OL displayed.</li> </ol>
<p>Control Power Fuse</p>	<p>All Drives have a Control Power Fuse. The fuse is located on either the Power PCB (3PCB) or the Gate Drive PCB (3PCB). The Control Power Fuse protects the primary switching mode power supply.</p> <ol style="list-style-type: none"> <li>1. Set a digital multi-meter to the R x 1 scale.</li> <li>2. Place one lead of the multi-meter on one side of the fuse and place the other lead of the multi-meter on the other side of the fuse.</li> <li>3. If the fuse is good, the measured value will be zero ohms. If the fuse is bad, the measured value will be infinite ohms.</li> </ol>

Table 6.6 Main Circuit Test Procedure

Check	Procedure
<p>24Vdc Cooling Fans (Heat Sink &amp; Internal)</p>	<p>The Heat Sink &amp; Internal Cooling Fans cool the heat sink as well as the output transistor modules of the Drive.</p> <ol style="list-style-type: none"> <li>1. Conduct a visual inspection to ensure the fan turns freely.</li> <li>2. If there is no physical evidence that the fan is bad, the fan motor can be checked with a digital mutli-meter.</li> <li>3. Set the digital multi-meter to the R x 1 scale.</li> <li>4. Measure across the fan motor terminals. If zero ohms are measured, conclude that the fan motor is shorted. If infinite ohms are measured, conclude that the fan motor is burned open.</li> <li>5. If the fan is not working, then disconnect the fan and apply 24Vdc to the fan to test the motor.</li> </ol>
<p>230/240Vac Cooling Fans (Heat Sink)</p>	<p>The Heat Sink Cooling Fans cool the heat sink to remove heat from the Drive.</p> <ol style="list-style-type: none"> <li>1. Conduct a visual inspection to ensure the fan turns freely.</li> <li>2. If there is no physical evidence that the fan is bad, the motor can be checked with a digital mutli-meter.</li> <li>3. Set a digital multi-meter to the R x 1 scale.</li> <li>4. Measure across the fan motor terminals. If the fan motor is good, the measured value should be about 500 ohms. If zero ohms are measured, conclude that the fan motor is shorted. If infinite ohms are measured, conclude that the fan motor is burned open.</li> </ol> <p>If the fan is not working, then disconnect the fan and apply 230/240Vac to the fan to test the motor.</p>
<p>Cooling Fan Fuse</p>	<p>Large Drive units contain a Cooling Fan Fuse. It is located on either the Gate Drive Board (3PCB) or the Tap Change Board (8PCB). If the Cooling Fan Fuse is open, then the 230/240Vac cooling fans may be defective.</p> <ol style="list-style-type: none"> <li>1. Set a digital multi-meter to the R x 1 scale.</li> <li>2. Place one lead of the multi-meter on one side of the fuse and place the other lead of the multi-meter on the other side of the fuse.</li> <li>3. If the fuse is good, the measured value will be zero ohms.</li> </ol> <p>If the fuse is bad, the measured value will be infinite ohms.</p>

# Drive Date Stamp Information

This information is used to determine when a Drive was built to see if it is within its warranty period. The date stamp is located on the lower right side of the Drive.

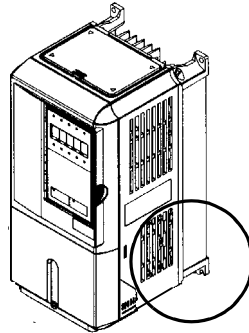
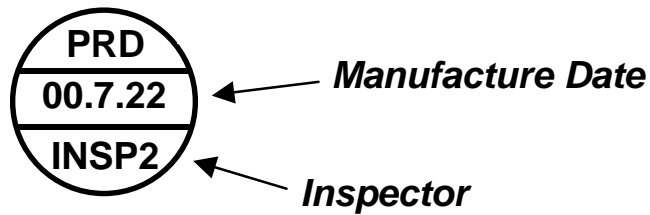

Fig 6.1 Date Stamp Location



# Chapter 7

## Maintenance

---

*This chapter describes basic maintenance and inspection of the Drive. Please refer to these instructions to ensure that the Drive receives the proper maintenance to maintain overall performance.*

Periodic Inspection .....	7-2
Preventive Maintenance .....	7-3
Heatsink Cooling Fan Replacement .....	7-4
Removing and Mounting the Terminal Card .....	7-6

# Periodic Inspection

Check the following items during periodic maintenance.

- The motor should not be vibrating or making unusual noises.
- There should be no abnormal heat generation from the Drive or motor.
- The ambient temperature should be within the Drive specification of -10°C to 40°C (14°F to 104°F).
- The output current value shown in parameter U1-03 should not be higher than the motor rated current for an extended period of time.
- The cooling fan in the Drive should be operating normally.

Always turn OFF the input power before beginning inspection. Confirm that the digital operator indicators on the front cover have all turned OFF, and then wait an additional five minutes before beginning the inspection. Be sure not to touch terminals immediately after the power has been turned off. Doing so can result in electric shock. Please refer to Warnings on page i.

## WARNING

Prior to removing any protective cover or wiring any part of the Drive, remove all power sources, including main input power and control circuit power. Wait a minimum of 5 minutes after power removal, before removing any cover. The charge lamp located within the Drive should be off prior to working inside. Even if the charge lamp is off, one must measure the AC input, output, and DC Bus potential to insure safe levels prior to resuming work. Failure to adhere to this warning may result in personal injury or death.

Table 7.1 Periodic Inspections With no Power Applied

Item	Inspection	Corrective Action
External terminals, mounting bolts, connectors, etc.	Are all screws and bolts tight?	Tighten loose screws and bolts firmly.
	Are connectors tight?	Reconnect the loose connectors.
Cooling fins	Are the fins dirty or dusty?	Clean off any dirt and dust with an air gun using clean and dry air at a pressure between 55-85 psi.
Control PCB Terminal PCB Power PCB Gate Drive PCBs	Is there any conductive dirt or oil mist on the PCBs?	Clean off any dirt and dust with an air gun using clean and dry air at a pressure between 55-85 psi. Replace the boards if they cannot be made clean.
Input Diodes IPMs Output Transistors	Is there any conductive dirt or oil mist on the modules or components?	Clean off any dirt and dust with an air gun using clean and dry air at a pressure between 55-85 psi.
DC bus capacitors	Are there any irregularities, such as discoloration or odor?	Replace the capacitors or Drive.

Apply power to the Drive and conduct the following inspection.

Table 7.2 Periodic Inspections With Power Applied

Item	Inspection	Corrective Action
Cooling fan(s)	Is there any abnormal noise or vibration, or has the total operating time exceeded 20,000 hours. Check U1-40 for elapsed cooling fan operation time.	Replace Cooling Fan

# Preventive Maintenance

Table 7.3 Preventive Maintenance				
Inspection Points	Item	Check Points	Every 3-6 Months	Yearly
General	Environment	Ambient Temperature Humidity Dust Harmful Gas Oil Mist	X X X X X	
	Equipment	Abnormal vibration or noise	X	
	AC Power Supply	Main circuit & control voltage	X	
AC Power Circuit & Devices	Conductors & Wire Connections	Loose lugs, screws & wires Hot spots on parts Corrosion Bent conductors Breakage, cracking or discoloration Check spacing		X X X X X X
	Transformers & Reactors	Discoloration or Noise	X	
	Terminal Blocks	Loose, damaged		X
	DC Bus Capacitors	Leakage Ruptures, broken, expansion Capacitance & insulation resistance		X X X
	Relays & Contactors	Noisy Contact discoloration		X X
	Soft Charge Resistors	Cracked Discoloration		X X
Control Circuits	Operation	Speed reference voltage/current I/O contact operation		X X
Cooling System	Cooling Fans/Fins & Heatsink	Abnormal fan noise Loose connectors Free of accumulation	X X	X
Keypad/Display	Digital Operator	LEDs Monitor display values Key functionality Clean	X X	X X

If the Drive is used under the following conditions, it may be necessary to inspect more often:

- High ambient temperatures, humidity or altitudes above 3,300 feet
- Frequent starting and stopping
- Fluctuations of the AC power supply or load
- Excessive vibration and/or shock loading
- Poor environment, including dust, metal particles, salt, sulfuric acid, chlorine

# Heatsink Cooling Fan Replacement

---

## ◆ Models CIMR-E7U20P4 thru 2018 (25HP @ 208V/240V) and 40P4 thru 4018 (30HP @ 480V)

A cooling fan is attached to the bottom of the Drive.

If the Drive is installed using the mounting holes on the back of the Drive heatsink, the cooling fan can be replaced without removing the Drive from the enclosure panel.

If the Drive is mounted with the heatsink external to the enclosure, the cooling fan can only be replaced by removing the Drive from the enclosure.

### ■Removing the Heatsink Cooling Fan

1. Always turn OFF the input power before removing and installing the heatsink cooling fan.
2. Press in on the right and left sides of the fan cover in the direction of arrows “1” and then pull the fan out in the direction of arrow “2”.
3. Pull out the cable connected to the fan from the fan cover and disconnect the power connector. See Figure 7.1
4. Open the fan cover on the left and right sides in the direction of arrows “3” and remove the fan cover from the fan.

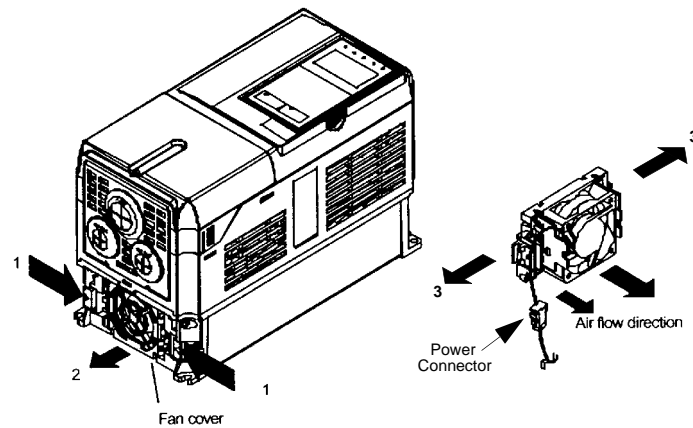

Fig 7.1 Cooling Fan Replacement Procedure

### ■Installing the Heatsink Cooling Fan

1. Attach the fan cover to the cooling fan. Be sure that the air flow direction indicated by the arrows above faces into the Drive.
2. Connect the power connector securely and place the power connector and cable into the fan cover.
3. Mount the fan cover on the Drive. Be sure that the tabs on the sides of the fan cover click into place on the Drive.

■ **Models CIMR-E7U2022 thru 2110 (30HP to 150HP @ 208V/240V) and 4030 thru 4300 (40HP to 500HP @ 480V)**

A cooling fan assembly is attached to the top inside the Drive. The cooling fan assembly includes the heat sink cooling fans and the internal cooling fan. The cooling fan(s) can be replaced without removing the Drive from the enclosure panel.

**Removing the Cooling Fan Assembly**

1. Always turn OFF the input power before removing and installing the heatsink cooling fan assembly.
2. Remove the terminal cover, Drive cover, Digital Operator, and front cover from the front of the Drive.
3. Remove the Control PCB bracket (if necessary) to which the cards are mounted. Remove all cables connected to the Control PCB and remove the cooling fan power connector from the fan board (13 PCB) positioned near the top of the Drive.
4. Remove the cooling fan power connectors from the gate drive board (3PCB) positioned at the back of the Drive.
5. Remove the fan assembly screws and pull out the fan assembly from the Drive.
6. Remove the cooling fan(s) from the fan assembly.

**Mounting the Cooling Fan Assembly**

After attaching a new cooling fan, reverse the above procedure to attach all of the components.

When attaching the cooling fan to the mounting bracket, be sure that the air flow goes toward the top of the Drive.

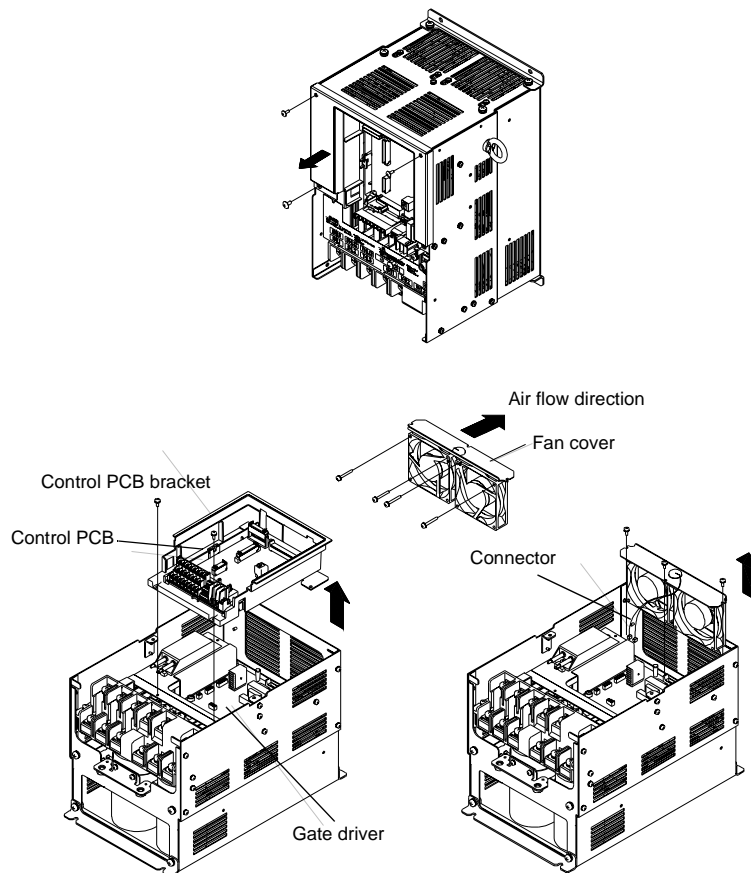

Fig 7.2 Cooling Fan Assembly Replacement Procedure

# Removing and Mounting the Terminal Card

The terminal card can be removed and mounted without disconnecting the control wiring.

## IMPORTANT

Always confirm that input power is removed and the Charge LED is not lit before removing or mounting the terminal card.

### ■Removing the Terminal Card

1. Remove the terminal cover on the Drive.
1. Remove the Digital Operator and front cover on the Drive.
2. Remove the wires connected to FE and NC on the terminal card.
3. Loosen the mounting screws on the left and right sides of the terminal card until they are free. It is not necessary to remove the mounting screws completely. They are captive and self-rising.
4. Pull the terminal card out in the direction of the block arrow.

### ■Mounting the Terminal Card

Reverse the removal procedure to mount the terminal card.

Confirm that the terminal card and the Control PCB properly meet at connector CN8 before insertion.

The connector pins may be bent if the terminal card is forced into place, possibly preventing correct Drive operation.

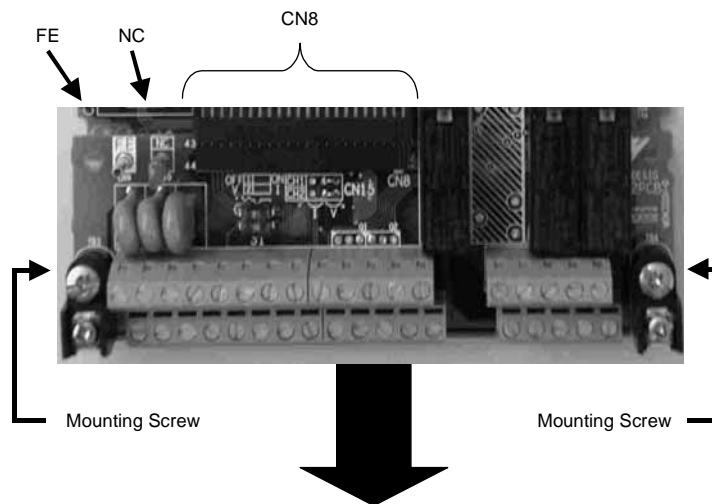

Fig 7.3 Terminal Card Removal Procedure

# Appendix A

## Parameters

---

*This appendix lists all the parameter numbers and names, along with a description of each. Also, below the parameter name in bold type is the abbreviated name as it appears on the digital operator display/keypad.*

Parameter List .....	A-2
Monitor List .....	A-26
Fault Trace List .....	A-28
Fault History List .....	A-29
Decimal to Hex Conversion .....	A-30

# Parameter List

Table A.1 Parameter List

Parameter No.	Parameter Name Digital Operator Display	Description	Setting Range	Factory Setting	Menu Location
<b>Initialization</b>					
A1-00 ◆	Language Selection <b>Select Language</b>	Language selection for digital operator display 0: English 2: Deutsch 3: Francais 4: Italiano 5: Espanol 6: Portugues *Not returned to factory setting by initialization	0 to 6	0	Programming
A1-01 ◆	Access Level Selection <b>Access Level</b>	This setting determines which parameters are accessible. 0: Operation Only 1: User Level 2: Advanced Level	0 to 2	2	Programming
A1-03	Initialize Parameters <b>Init Parameters</b>	Used to return all parameters to their factory or user setting. 0: No Initialize 1110: User Initialize (The user must set their own parameter default values and then parameter 02-03 must be set to "1" to save them. If the parameter values are changed after 02-03 is set to "1", the user default values can be restored by setting A1-03 to 1110) 2220: 2-Wire Initial 3330: 3-Wire Initial	0 to 3330	0	Programming
A1-04	Password 1 <b>Enter Password</b>	When the value set into A1-04 does NOT match the value set into A1-05, parameters A1-01 thru A1-03 and A2-32 cannot be changed. All other parameters determined by A1-01 can be changed. Parameter A1-05 can be accessed by displaying parameter A1-04, then press and hold the RESET key along with the MENU key simultaneously.	0 to 9999	0	Programming
A1-05	Password 2 <b>Select Password</b>		0 to 9999	0	Programming
<b>User Parameters</b>					
A2-01	User Parameter 1 <b>User Param 1</b>	Selects the parameters to be available in the User Access Level (A1-01 = 1). These are the only parameters accessible for the user level. These parameters are not related to the User Initialize function.	b1-01 to 03-02	—	Programming
A2-02	User Parameter 2 <b>User Param 2</b>			—	Programming
A2-03	User Parameter 3 <b>User Param 3</b>			—	Programming
A2-04	User Parameter 4 <b>User Param 4</b>			—	Programming
A2-05	User Parameter 5 <b>User Param 5</b>			—	Programming
A2-06	User Parameter 6 <b>User Param 6</b>			—	Programming
◆Denotes that parameter can be changed when the drive is running.					

Table A.1 Parameter List (Continued)

Parameter No.	Parameter Name Digital Operator Display	Description	Setting Range	Factory Setting	Menu Location
A2-07	User Parameter 7 <b>User Param 7</b>	Selects the parameters to be available in the User Access Level (A1-01 = 1). These are the only parameters accessible for the user level. These parameters are not related to the User Initialize function.	b1-01 to o3-02	—	Programming
A2-08	User Parameter 8 <b>User Param 8</b>			—	Programming
A2-09	User Parameter 9 <b>User Param 9</b>			—	Programming
A2-10	User Parameter 10 <b>User Param 10</b>			—	Programming
A2-11	User Parameter 11 <b>User Param 11</b>			—	Programming
A2-12	User Parameter 12 <b>User Param 12</b>			—	Programming
A2-13	User Parameter 13 <b>User Param 13</b>			—	Programming
A2-14	User Parameter 14 <b>User Param 14</b>			—	Programming
A2-15	User Parameter 15 <b>User Param 15</b>			—	Programming
A2-16	User Parameter 16 <b>User Param 16</b>			—	Programming
A2-17	User Parameter 17 <b>User Param 17</b>			—	Programming
A2-18	User Parameter 18 <b>User Param 18</b>			—	Programming
A2-19	User Parameter 19 <b>User Param 19</b>			—	Programming
A2-20	User Parameter 20 <b>User Param 20</b>			—	Programming
A2-21	User Parameter 21 <b>User Param 21</b>			—	Programming
A2-22	User Parameter 22 <b>User Param 22</b>			—	Programming
A2-23	User Parameter 23 <b>User Param 23</b>			—	Programming
A2-24	User Parameter 24 <b>User Param 24</b>			—	Programming
A2-25	User Parameter 25 <b>User Param 25</b>			—	Programming
A2-26	User Parameter 26 <b>User Param 26</b>			—	Programming
A2-27	User Parameter 27 <b>User Param 27</b>			—	Programming
A2-28	User Parameter 28 <b>User Param 28</b>			—	Programming
A2-29	User Parameter 29 <b>User Param 29</b>			—	Programming
A2-30	User Parameter 30 <b>User Param 30</b>			—	Programming
A2-31	User Parameter 31 <b>User Param 31</b>			—	Programming
A2-32	User Parameter 32 <b>User Param 32</b>			—	Programming

Table A.1 Parameter List (Continued)

Parameter No.	Parameter Name Digital Operator Display	Description	Setting Range	Factory Setting	Menu Location
<b>Sequence</b>					
b1-01	Frequency Reference Selection <b>Reference Source</b>	Selects the speed command (frequency reference) input source. 0: Operator - Digital preset speed d1-01 1: Terminals - Analog Input Terminal A1 (or Terminal A2 see parameter H3-13) 2: Serial Com - RS-485 terminals R+, R-, S+ and S- 3: Option PCB - Option board connected at 2CN	0 to 3	1	Quick Setting
b1-02	Run Command Selection <b>Run Source</b>	Selects the run command input source. 0: Operator - "Hand" and "Off" keys on digital operator 1: Terminals - Contact Closure on Terminal S1 2: Serial Com - RS-485 terminals R+, R-, S+ and S- 3: Option PCB - Option board connected at 2CN	0 to 3	1	Quick Setting
b1-03	Stopping Method Selection <b>Stopping Method</b>	Selects the stopping method when the run command is removed. 0: Ramp to Stop 1: Coast to Stop 2: DC Injection to Stop 3: Coast w/Timer (A new run command is ignored if input before the time in C1-02 expires)	0 to 3	0	Quick Setting
b1-04	Reverse Operation Selection <b>Reverse Oper</b>	Determines the forward rotation of the motor, and if reverse operation is disabled. 0: Reverse Enabled 1: Reverse Disabled 2: Exchange Phase - Change direction of forward motor rotation 3: Exchange Phase, Reverse Disabled - Change direction of forward motor rotation and disable reverse operation	0 to 3	1	Programming
b1-07	Local/Remote Run Selection <b>LOC/REM RUN Sel</b>	0: Cycle External RUN - If the run command is closed when switching from hand (local) mode to auto (remote) mode, the drive will not run 1: Accept External RUN - If the run command is closed when switching from hand (local) mode to auto (remote) mode, the drive WILL run	0 or 1	0	Programming
b1-08	Run Command Selection During Program <b>RUN CMD at PRG</b>	0: Disabled - Run command accepted only in the operation menu. 1: Enabled - Run command accepted in all menus (except when b1-02 = 0)	0 or 1	0	Programming
b1-11	Drive Delay Time Setting <b>Wait to Run Time</b>	After a run command, drive output will start after this delay time.	0 to 600	0sec	Programming
b1-12	Hand Frequency Reference Selection <b>HAND Fref Source</b>	Selects the speed command input source in hand mode.* 0: Operator - Digital preset speed d1-01 1: Terminals - Analog Input Terminal A1 (or Terminal A2 see parameter H3-13)	0 or 1	0	Programming
b1-13	HAND/AUTO During Run Selection <b>HAND/AUTO @Run</b>	Selects if drive will permit switching between HAND and AUTO modes while running. 0: Disabled 1: Enabled	0 or 1	0	Programming
b1-14	Emergency Override Speed <b>E Override Speed</b>	Sets the speed command used in emergency override mode when b1-15=0.	0.00 to 120.00 Hz	0.00	Programming
b1-15	Emergency Override Reference Selection <b>E OverrideRefSel</b>	Selects the emergency override reverse source. 0: Use b1-14 Ref 1: Use AUTO Ref	0 or 1	0	Programming
<b>DC Braking</b>					
b2-01	DC Injection Braking Start Frequency <b>DCInj Start Freq</b>	Sets the frequency at which DC injection braking starts when ramp to stop (b1-03 = 0) is selected. If b2-01 < E1-09, DC Injection braking starts at E1-09.	0.0 to 10.0	0.5Hz	Programming
b2-02	DC Injection Braking Current <b>DCInj Current</b>	Selects the DC injection braking current as a percentage of the Drive rated current.	0 to 100	50%	Programming
b2-03	DC Injection Braking Time at Start <b>DCInj Time @Start</b>	Sets the time length of DC injection braking at start in units of 1 second.	0.00 to 10.00	0.00sec	Programming
b2-04	DC Injection Braking Time at Stop <b>DCInj Time @Stop</b>	When b1-03 = 2 actual DC Injection time is calculated as follows: b2-04 * 10 * Output Frequency / E1-04. When b1-03 = 0, this parameter determines the amount of time DC Injection is applied to the motor at the end of the decel ramp. This should be set to a minimum of 0.50 seconds when using HSB. This will activate DC injection during the final portion of HSB and help ensure that the motor stops completely.	0.00 to 10.00	0.00sec	Programming
* If b1-13=1, this parameter instead selects whether the AUTO reference is retained as the new HAND reference (setting=0), or the drive will ramp from the AUTO reference to the existing HAND reference (setting=1).					

Table A.1 Parameter List (Continued)

Parameter No.	Parameter Name Digital Operator Display	Description	Setting Range	Factory Setting	Menu Location
b2-09	Motor Pre-Heat Current <b>Preheat Current</b>	Motor Pre-heat current in % of drive rated current. This is used to keep the motor warm to prevent condensation and is used in conjunction with a digital input (data = 60).	0 to100	0%	Programming
b2-10	Motor Pre-Heat Current 2 <b>Preheat Current2</b>	Sets the DC preheat current for multi-function output setting 80 (Motor Preheat 2) as a percentage of Motor Rated Current (E2-01).	0 to 10%	5	Programming
<b>Speed Search</b>					
b3-01	Speed Search Selection <b>SpdSrch at Start</b>	Enables/disables and selects the speed search function at start. 0: SpdsrchF Disable - Speed search at start is disabled (estimated speed method is used at other times) 1: SpdsrchF Enable - Speed search is enabled (estimated speed method) 2: SpdsrchI Disable - Speed search at start is disabled (current detection method is used at other times) 3: SpdsrchI Enable - Speed search is enabled (current detection method) Estimated Speed Method: Actual motor speed and direction is estimated, then the motor is ramped from that speed to the commanded speed. Current Detection Method: Current level is monitored while output frequency is ramped down.	0 to 3	2	Programming
b3-02	Speed Search Deactivation Current <b>SpdSrch Current</b>	Used only when b3-01 = 3. Sets the speed search operation current as a percentage of drive rated current.	0 to 200	120%	Programming
b3-03	Speed Search Deceleration Time <b>SpdSrch Dec Time</b>	Used only when b3-01 = 3. Sets the deceleration time during speed search.	0.1 to 10.0	2.0sec	Programming
b3-05	Speed Search Delay Time <b>Search Delay</b>	Delays the speed search operation after a momentary power loss to allow time for an external output contactor to re-energize.	0.0 to 20.0sec	0.2sec	Programming
b3-14	Bidirectional Speed Search Selection <b>Bidir Search Sel</b>	0: Disabled 1: Enabled	0 or 1	1	Programming
<b>Delay Timers</b>					
b4-01	Timer Function ON-Delay Time <b>Delay-ON Timer</b>	Used in conjunction with a multi-function digital input and a multi-function digital output. This sets the amount of time between when the digital input is closed, and the digital output is energized.	0.0 to 3000.0	0.0sec	Programming
b4-02	Timer Function OFF-Delay Time <b>Delay-OFF Timer</b>	Used in conjunction with a multi-function digital input and a multi-function digital output. This sets the amount of time the output stays energized after the digital input is opened.	0.0 to 3000.0	0.0sec	Programming
<b>PI Control</b>					
b5-01	PI Mode Setting <b>PI Mode</b>	This parameter enables / disables the closed loop (PI) controller. 0: Disabled 1: Enabled (commanded speed becomes PI setpoint) 3: Fref+PI	0, 1, 3	0	Quick Setting
b5-02 ◆	Proportional Gain Setting <b>P Gain</b>	Sets the proportional gain of the PI controller.	0.00 to 25.00	2.00	Quick Setting*
b5-03 ◆	Integral Time Setting <b>PI I Time</b>	Sets the integral time for the PI controller. A setting of zero disables integral control.	0.0 to 360.0	5.0sec	Quick Setting*
b5-04 ◆	Integral Limit Setting <b>PI I Limit</b>	Sets the maximum output possible from the integrator. Set as a % of fmax.	0.0 to 100.0	100%	Programming
b5-06 ◆	PI Output Limit <b>PI Limit</b>	Sets the maximum output possible from the entire PI controller. Set as a % of fmax.	0.00 to 100.0	100.0%	Programming
b5-07 ◆	PI Offset Adjustment <b>PI Offset</b>	Sets the amount of offset of the output of the PI controller. Set as a % of fmax. The PI Offset Adjustment parameter has two different uses. Parameter b5-07 serves different functions depending on whether it is used on a standard PI loop or a Differential PI loop. 1: Parameter b5-07 causes an offset to be applied to the output of the PI function in a non-Differential PI loop. Every time the PI output is updated, the offset is summed with the PI output. This can be used to artificially kick-start a slow starting PI loop. 2: If the Drive is configured for Differential PI Regulation (H3-09=16), then the PI Offset is the targeted maintained differential between the signal measured on analog input A1 and the signal measured on analog input A2.	-100.0 to +100.0	0.0%	Programming

◆ Denotes that parameter can be changed when the drive is running. \* Menu location is Quick Setting when b5-01=1, and Programming when b5-01=0.

Table A.1 Parameter List (Continued)

Parameter No.	Parameter Name Digital Operator Display	Description	Setting Range	Factory Setting	Menu Location
b5-08 ◆	PI Primary Delay Time Constant <b>PI Delay Time</b>	Sets the amount of time for a filter on the output of the PI controller.	0.00 to 10.00	0.00sec	Programming
b5-09	PI Output Level Selection <b>Output Level Sel</b>	Determines whether the PI controller will be direct or reverse acting. 0: Normal Output (direct acting) 1: Reverse Output (reverse acting)	0 or 1	0	Programming
b5-10	PI Output Gain Setting <b>Output Gain</b>	Sets the output gain of the PI controller.	0.0 to 25.0	1.0	Programming
b5-11	PI Output Reverse Selection <b>Output Rev Sel</b>	0: 0 limit (when PI output goes negative Drive stops) 1: Reverse (when PI goes negative Drive reverses) 0 limit automatic when reverse prohibit is selected using b1-04	0 or 1	0	Programming
b5-12	PI Feedback Reference Missing Detection Selection <b>Fb los Det Sel</b>	0: Disabled 1: Alarm 2: Fault	0 to 2	0	Programming
b5-13	PI Feedback Loss Detection Level <b>Fb los Det Lvl</b>	Sets the PI feedback loss detection level as a percentage of maximum frequency (E1-04).	0 to 100	0%	Programming
b5-14	PI Feedback Loss Detection Time <b>Fb los Det Time</b>	Sets the PI feedback loss detection delay time in terms of seconds.	0.0 to 25.5	1.0sec	Programming
b5-15	Sleep Function Start Level <b>Sleep Level</b>	Sets the sleep function start frequency.	0.0 to 200.0	0.0Hz	Programming
b5-16	Sleep Delay Time <b>Sleep Time</b>	Sets the sleep function delay time in terms of seconds.	0.0 to 25.5	0.0sec	Programming
b5-17	PI Accel/Decel Time <b>Acc/Dec Time</b>	Applies an accel/decel time to the PI setpoint reference.	0.0 to 25.5	0.0sec	Programming
b5-18	PI Setpoint Selection <b>PI Setpoint Sel</b>	0: Disabled 1: Enabled	0 or 1	0	Programming
b5-19 ◆	PI Setpoint Value <b>PI Setpoint</b>	Depends on b5-20.	0.00 to 100.00**	0.00%	Programming
b5-20	PI Setpoint Display Scaling <b>Setpoint Scaling</b>	Set display/setting Unit of b5-19, U1-24, and U1-38.	0 to 39999	1	Programming
b5-21	PI Sleep Input Source <b>PI Sleep Source</b>	Input Source Selection for Sleep function Mode. 0: PI Setpoint 1: SFS Input (This is near the PI output) 2: Snooze	0 to 2	1	Programming
b5-22 ◆	PI Snooze Level <b>Snooze Level</b>	Sets the PI snooze function start level as a percentage of maximum frequency (E1-04).	0 to 100	0%	Programming
b5-23	PI Snooze Delay Time <b>Snooze Delay Time</b>	Sets the PI snooze function delay time in terms of seconds.	0 to 3600	0sec	Programming
b5-24	PI Snooze Deactivation Level <b>Wake-Up Level</b>	When the PI feedback drops below this level, normal PI operation starts again. Set as a percentage of maximum frequency (E1-04).	0 to 100	0%	Programming
b5-25	PI Setpoint Boost Setting <b>Setpoint Boost</b>	Temporary increase of PI setpoint to create an overshoot of the intended PI setpoint.	0 to 100	0%	Programming
b5-26	PI Maximum Boost Time <b>Max Boost Time</b>	Sets a time limitation for reaching temporarily boosted PI setpoint (intended PI setpoint + b5-25).	0 to 3600	0sec	Programming
b5-27	PI Snooze Feedback Level <b>Snooze Feedback</b>	PI snooze mode will be activated when PI feedback is above this level. Set as a percentage of maximum frequency (E1-04).	0 to 100	60%	Programming

◆Denotes that parameter can be changed when the drive is running. \*\* Range depends on b5-20 setting. Units depend on b5-31 setting.

Table A.1 Parameter List (Continued)

Parameter No.	Parameter Name Digital Operator Display	Description	Setting Range	Factory Setting	Menu Location
b5-28	PI Feedback Square Root Function Selection <b>PI Feedback SqRt</b>	0: Disabled 1: Enabled	0 or 1	0	Programming
b5-29	PI Square Root Gain <b>PI Fb SqRt Gain</b>	A multiplier applied to the square root of the feedback.	0.00 to 2.00	1.00	Programming
b5-30	Output Square Root Monitor Selection <b>PI Out Moni SqRt</b>	0: Disabled 1: Enabled	0 or 1	0	Programming
b5-31	PI Unit Selection <b>PI Unit Sel</b>	Sets units for b5-19, U1-24, U1-38. 0: WC:InchOfWater 1: PSI:lb/SqrInch 2: GPM:Gallons/Min 3: F:DegFahrenheit 4: CFM:Cubic ft/Min 5: CMH:Cubic M/Hr 6: LPH:Liters/Hr 7: LPS:Liters/Sec 8: Bar:Bar 9: Pa:Pascals 10: C:DegCelsius 11: Mtr:Meters	0 to 11	0	Quick Setting*
<b>Energy Saving</b>					
b8-01	Energy Saving Control Selection <b>Energy Save Sel</b>	Energy Savings function enable/disable selection 0: Disabled 1: Enabled	0 or 1	0	Quick Setting
b8-04	Energy Saving Coefficient Value <b>Energy Save COEF</b>	Used to fine-tune the energy savings function.	0.0 to 655.00	kVA Dependent	Programming
b8-05	Power Detection Filter Time <b>kW Filter Time</b>		0 to 2000	20ms	Programming
b8-06	Search Operation Voltage Limit <b>Search V Limit</b>		0 to 100	0%	Programming
<b>Accel / Decel</b>					
C1-01 ◆	Acceleration Time 1 <b>Accel Time 1</b>	Sets the time to accelerate from zero to maximum frequency.	0.0 to 6000.0	30.0sec	Quick Setting
C1-02 ◆	Deceleration Time 1 <b>Decel Time 1</b>	Sets the time to decelerate from maximum frequency to zero.		30.0sec	Quick Setting
C1-03 ◆	Acceleration Time 2 <b>Accel Time 2</b>	Sets the time to accelerate from zero to maximum frequency when selected via a multi-function input.		30.0sec	Programming
C1-04 ◆	Deceleration Time 2 <b>Decel Time 2</b>	Sets the time to decelerate from maximum frequency to zero when selected via a multi-function input.		30.0sec	Programming
C1-09	Fast Stop Time <b>Fast Stop Time</b>	Sets the time to decelerate from maximum frequency to zero for the "Fast Stop" function.	0.0 to 6000.0	10.0sec	Programming
C1-11	Accel/Decel Switch Frequency <b>Acc/Dec SW Freq</b>	Sets the frequency for automatic switching of accel / decel times. Fout < C1-11: Accel/Decel Time 2 Fout >= C1-11: Accel/Decel Time 1 Multi-function input "Multi-Acc/Dec 1" has priority over C1-11.	0.0 to 200.0	0.0Hz	Programming
◆ Denotes that parameter can be changed when the Drive is running. * Menu location is Programming when PI is disabled and Quick Setting when PI is enabled.					

Table A.1 Parameter List (Continued)

Parameter No.	Parameter Name Digital Operator Display	Description	Setting Range	Factory Setting	Menu Location
<b>S-Curve Acc/Dec</b>					
C2-01	S-Curve Characteristic at Accel Start <b>SCrv Acc @ Start</b>	S-curve is used to further soften the starting ramp. The longer the S-curve time, the softer the starting ramp.	0.00 to 2.50	0.20sec	Programming
C2-02	S-Curve Characteristic at Accel End <b>SCrv Acc @ End</b>		0.00 to 2.50	0.20sec	Programming
<b>Torque Comp</b>					
C4-01 ◆	Torque Compensation Gain <b>Torq Comp Gain</b>	This parameter helps to produce better starting torque. It determines the amount of torque or voltage boost based upon motor current and motor resistance.	0.00 to 2.50	1.00	Programming
C4-02	Torque Compensation Primary Delay Time <b>Torq Comp Time</b>	This parameter adjusts a filter on the output of the torque compensation function. Increase to add torque stability, decrease to improve torque response.	0 to 10000	200ms	Programming
<b>Carrier Freq</b>					
C6-01	Normal Duty Selection <b>Normal Duty Sel</b>	1: Normal Duty 1 2: Normal Duty 2	1 or 2	2	Programming
C6-02	Carrier Frequency Selection <b>CarrierFreq Sel</b>	Carrier frequency sets the number of pulses per second of the output voltage waveform. 0: Low Noise (Carrier frequency is randomly modulated for lower audible noise) 1: Fc = 2.0 kHz 2: Fc = 5.0 kHz 3: Fc = 8.0 kHz 4: Fc = 10.0 kHz 5: Fc = 12.5 kHz 6: Fc = 15.0 kHz F: Program (Determined by the settings of C6-03 thru C6-05)	0 to F	kVA Dependent	Programming
C6-03	Carrier Frequency Upper Limit <b>CarrierFreq Max</b>	Maximum carrier frequency allowed when C6-02 = F.	0.4 to 15.0 kHz	kVA Dependent	Programming
C6-04	Carrier Frequency Lower Limit <b>CarrierFreq Min</b>	Minimum carrier frequency allowed when C6-02 = F.	0.4 to 15.0 kHz	kVA Dependent	Programming
C6-05	Carrier Frequency Proportional Gain <b>CarrierFreq Gain</b>	Sets the relationship of output frequency to carrier frequency when C6-02 = F.	0 to 99	0	Programming
<b>Preset Reference (Speeds)</b>					
d1-01 ◆	Frequency Reference 1 <b>Reference 1</b>	Digital preset speed command 1. Used when b1-01 = 0 and when in "hand" mode. Setting units are affected by o1-03.	0.00 to E1-04 Value	0.00Hz	Programming
d1-02 ◆	Frequency Reference 2 <b>Reference 2</b>	Digital preset speed command 2. Selected via multi-function input terminals. Setting units are affected by o1-03.		0.00Hz	Programming
d1-03 ◆	Frequency Reference 3 <b>Reference 3</b>	Digital preset speed command 3. Selected via multi-function input terminals. Setting units are affected by o1-03.		0.00Hz	Programming
d1-04 ◆	Frequency Reference 4 <b>Reference 4</b>	Digital preset speed command 4. Selected via multi-function input terminals. Setting units are affected by o1-03.		0.00Hz	Programming
d1-17 ◆	Jog Frequency Reference <b>Jog Reference</b>	Speed command used when a jog is selected via multi-function input terminals. Setting units are affected by o1-03.	0.00 to E1-04 Value	6.00Hz	Programming

◆Denotes that parameter can be changed when the drive is running.

Table A.1 Parameter List (Continued)

Parameter No.	Parameter Name Digital Operator Display	Description	Setting Range	Factory Setting	Menu Location
<b>Reference Limits</b>					
d2-01	Frequency Reference Upper Limit <b>Ref Upper Limit</b>	Determines maximum speed command, set as a percentage of parameter E1-04. If speed command is above this value, actual drive speed will be limited to this value. This parameter applies to all speed command sources.	0.0 to 110.0	100.0%	Quick Setting
d2-02	Frequency Reference Lower Limit <b>Ref Lower Limit</b>	Determines minimum speed command, set as a percentage of parameter E1-04. If speed command is below this value, actual drive speed will be set to this value. This parameter applies to all speed command sources.	0.0 to 110.0	0.0%	Quick Setting
d2-03	Master Speed Reference Lower Limit <b>Ref1 Lower Limit</b>	Determines the minimum speed command, set as a percentage of parameter E1-04. If speed command is below this value, actual drive speed will be set to this value. This parameter only applies to analog inputs A1 and A2.	0.0 to 110.0	0.0%	Programming
<b>Jump Frequencies</b>					
d3-01	Jump Frequency 1 <b>Jump Freq 1</b>	These parameters allow programming of up to three prohibited frequency points for eliminating problems with resonant vibration of the motor / machine. This feature does not actually eliminate the selected frequency values, but will accelerate and decelerate the motor through the prohibited bandwidth.	0.0 to 200.0	0.0Hz	Programming
d3-02	Jump Frequency 2 <b>Jump Freq 2</b>			0.0Hz	Programming
d3-03	Jump Frequency 3 <b>Jump Freq 3</b>			0.0Hz	Programming
d3-04	Jump Frequency Width <b>Jump Bandwidth</b>	This parameter determines the width of the deadband around each selected prohibited frequency point. A setting of "1.0" will result in a deadband of +/- 1.0 Hz.	0.0 to 20.0	1.0Hz	Programming
<b>MOP and Trim Control</b>					
d4-01	<b>MOP Ref Memory</b>	0: Disabled 1: Enabled	0 or 1	0	Programming
d4-02	Trim Control Level <b>Trim Control Lvl</b>	Set the percentage of maximum speed to be added or subtracted via multi-function inputs.	0 to 100	10%	Programming

Table A.1 Parameter List (Continued)

Parameter No.	Parameter Name Digital Operator Display	Description	Setting Range	Factory Setting	Menu Location	
<b>V/F Pattern</b>						
E1-01	Input Voltage Setting <b>Input Voltage</b>	Set to the nominal voltage of the incoming line.	155 to 255.0 (240V) 310 to 510.0 (480V)	240V 480V	Quick Setting	
E1-03	V/F Pattern Selection <b>V/F Selection</b>	0: 50Hz 1: 60 Hz Saturation 2: 50 Hz Saturation 3: 72 Hz 4: 50 Hz VT1 5: 50 Hz VT2 6: 60 Hz VT1 7: 60 Hz VT2 8: 50 Hz HST1 9: 50 Hz HST2 A: 60 Hz HST1 B: 60 Hz HST2 C: 90 Hz D: 120 Hz F: Custom V/F FF: Custom w/o limit	0 to FF	F	Programming	
E1-04	Maximum Output Frequency <b>Max Frequency</b>	<p>Output voltage (V)</p> <p>Frequency (Hz)</p> <p>To set V/f characteristics in a straight line, set the same values for E1-07 and E1-09. In this case, the setting for E1-08 will be disregarded. Always ensure that the four frequencies are set in the following manner: E1-04 (FMAX) ≥ E1-06 (FA) &gt; E1-07 (FB) ≥ E1-09 (FMIN)</p>	0.0 to 120.0	60.0Hz	Programming	
E1-05	Maximum Output Voltage <b>Max Voltage</b>		0 to 255.0 (240V) 0 to 510.0 (480V)	230.0V 460.0V	Programming	
E1-06	Base Frequency <b>Base Frequency</b>		0.0 to 200.0	60.0Hz	Programming	
E1-07	Mid Output Frequency A <b>Mid Frequency A</b>		0.0 to 200.0	3.0Hz	Programming	
E1-08	Mid Output Voltage A <b>Mid Voltage A</b>		0 to 255.0 (240V) 0 to 510.0 (480V)	18.0VAC	Programming	
E1-09	Minimum Output Frequency <b>Min Frequency</b>		0.0 to 200.0	1.5Hz	Programming	
E1-10	Mid Output Voltage <b>Min Voltage</b>		0 to 255.0 (240V) 0 to 510.0 (480V)	10.8VAC	Programming	
E1-11	Mid Output Frequency B <b>Mid Frequency B</b>		0.0 to 200.0	0.0Hz	Programming	
E1-12	Mid Output Voltage B <b>Mid Voltage B</b>		Set only when V/f is finely adjusted at rated output range. Adjustment is not normally required.	0 to 255.0 (240V) 0 to 510.0 (480V)	0.0VAC	Programming
E1-13	Base Voltage <b>Base Voltage</b>		0 to 255.0 (240V) 0 to 510.0 (480V)	0.0VAC	Programming	

Table A.1 Parameter List (Continued)

Parameter No.	Parameter Name Digital Operator Display	Description	Setting Range	Factory Setting	Menu Location
<b>Motor Setup</b>					
E2-01	Motor Rated Current <b>Motor Rated FLA</b>	Set to the motor nameplate full load amps.	10% to 200%	kVA Dependent	Quick Setting
E2-03	<b>No-Load Current</b>	Sets the magnetizing current of the motor.	kVA Dependent	kVA Dependent	Programming
E2-05	Motor Line-to-Line Resistance <b>Term Resistance</b>	Phase to phase motor resistance, normally set by the autotuning routine.	0.000 to 65.000	kVA Dependent	Programming
<b>Com OPT Setup</b>					
F6-01	Operation Selection after Communication Error <b>Comm Bus Flt Sel</b>	Sets the stopping method for option PCB communications error (BUS fault). Active only when a communications option PCB is installed and when b1-01 or b1-02 = 3. 0: Ramp to Stop 1: Coast to Stop 2: Fast-Stop 3: Alarm Only	0 to 3	1	Programming
F6-02	Detection Selection of External Fault from Communication Option Card <b>EFO Detection</b>	0: Always detected 1: Detected only during run	0 or 1	0	Programming
F6-03	Stopping Method for External Fault from Communication Option Card <b>EFO Fault Action</b>	0: Ramp to Stop 1: Coast to Stop 2: Fast-Stop 3: Alarm Only	0 to 3	1	Programming
F6-05	Current Monitor Display Unit Selection <b>Current Unit Sel</b>	0: A Display (Amps Display) 1: 100%/8192 (Drive Rated Current)	0 or 1	0	Programming

Table A.1 Parameter List (Continued)

Parameter No.	Parameter Name Digital Operator Display	Description	Setting Range	Factory Setting	Menu Location
<b>Digital Inputs</b>					
H1-01	Terminal S3 Function Selection <b>Terminal S3 Sel</b>	<p>0: 3-wire control FWD/REV selection for 3-wire sequence</p> <p>1: Local/Remote Sel Hand/Auto Selection - Closed = Hand, Open = Auto</p> <p>2: Option/Inv Sel Selects source of speed command and sequence Closed = b1-01 &amp; b1-02, Open = Option Card</p> <p>3: Multi-Step Ref 1 Closed = speed command from d1-02 or Aux Terminal Open = speed command determined by b1-01</p> <p>4: Multi-Step Ref 2 Closed = speed command from d1-03 or d1-04 Open speed command determined by b1-01</p> <p>6: Jog Freq Ref Closed = speed command from d1-17 Open = speed command determined by b1-01</p> <p>7: Multi-Acc/Dec 1 Closed = Accel &amp; Decel Ramps determined by C1-03 &amp; C1-04, Open = Accel &amp; Decel Ramps determined by C1-01 &amp; C1-02</p> <p>8: Ext BaseBlk N.O. Closed = Output transistors forced off Open = Normal operation</p> <p>9: Ext BaseBlk N.C. Closed = Normal Operation Open = Output transistors forced off</p> <p>A: Acc/Dec Ramp Hold Closed = Acceleration suspended and speed held Open = Normal Operation</p> <p>C: Term A2 Enable Closed = Terminal A2 is active Open = Terminal A2 is disabled</p> <p>F: Term Not Used Terminal has no effect</p> <p>10: MOP Increase Closed = Speed Command Increases Open = Speed Command Held. Must be set in conjunction with MOP Decrease and b1-02 must be set to 1.</p> <p>11: MOP Decrease Closed = Speed Command Decreases Open = Speed Command Held. Must be set in conjunction with MOP Increase and b1-02 must be set to 1.</p> <p style="text-align: center;">(Continued on following page).</p>	0 to 6E	24	Programming
H1-02	Terminal S4 Function Selection <b>Terminal S4 Sel</b>	<p>10: MOP Increase Closed = Speed Command Increases Open = Speed Command Held. Must be set in conjunction with MOP Decrease and b1-02 must be set to 1.</p> <p>11: MOP Decrease Closed = Speed Command Decreases Open = Speed Command Held. Must be set in conjunction with MOP Increase and b1-02 must be set to 1.</p> <p style="text-align: center;">(Continued on following page).</p>	0 to 6E	14	Programming

Table A.1 Parameter List (Continued)

Parameter No.	Parameter Name Digital Operator Display	Description	Setting Range	Factory Setting	Menu Location
H1-03	Terminal S5 Function Selection <b>Terminal S5 Sel</b>	<p>12: Forward Jog Closed = drive runs forward at speed command entered into parameter d1-17</p> <p>13: Reverse Jog Closed = drive runs in reverse at speed command entered into parameter d1-17</p> <p>14: Fault Reset Closed = Resets the drive after the fault and the run command have been removed</p> <p>15: Fast-Stop N.O. Closed = Drive decelerates using C1-09, regardless of run command status</p> <p>17: Fast-Stop N.C. Closed = Normal operation Open = Drive decelerates using C1-09, regardless of run command status</p> <p>18: Timer Function Input for independent timer, controlled by b4-01 and b4-02. Used in conjunction with a multi-function digital output.</p> <p>19: PI Disable Turns off the PI controller, and PI setpoint becomes speed command</p> <p>1B: Program Lockout Closed = All parameter settings can be changed. Open = Only speed command at U1-01 can be changed.</p> <p>1C: TrimCtl Increase Closed = Increase motor speed by value in d4-02. Open = Return to normal speed command. Not effective when using d1-01 thru d1-04 as a speed command. Must be used in conjunction with Trim Ctrl Decrease.</p> <p>1D: Trim Ctl Decrease Closed = Decrease motor speed by value in d4-02 Open = Return to normal speed command. Not effective when using d1-01 thru d1-04 as speed command. Must be used in conjunction with Trim Ctrl Increase.</p>	0 to 6E	3: 2-wire 0: 3-wire	Programming

Table A.1 Parameter List (Continued)

Parameter No.	Parameter Name Digital Operator Display	Description	Setting Range	Factory Setting	Menu Location
<b>Digital Inputs</b>					
H1-04	Terminal S6 Function Selection <b>Terminal S6 Sel</b>	<p>1E: Ref Sample Hold Analog speed command is sampled then held at time of input closure.</p> <p>20: External fault, Normally Open, Always Detected, Ramp To Stop</p> <p>21: External fault, Normally Closed, Always Detected, Ramp To Stop</p> <p>22: External fault, Normally Open, During Run, Ramp To Stop</p> <p>23: External fault, Normally Closed, During Run, Ramp To Stop</p> <p>24: External fault, Normally Open, Always Detected, Coast To Stop</p> <p>25: External fault, Normally Closed, Always Detected, Coast To Stop</p> <p>26: External fault, Normally Open, During Run, Coast To Stop</p> <p>27: External fault, Normally Closed, During Run, Coast To Stop</p> <p>28: External fault, Normally Open, Always Detected, Fast-Stop</p> <p>29: External fault, Normally Open, Always Detected, Fast-Stop</p> <p>2A: External fault, Normally Open, During Run, Fast-Stop</p> <p>2B: External fault, Normally Closed, During Run, Fast-Stop</p> <p>2C: External fault, Normally Open, Always Detected, Alarm Only</p> <p>2D: External fault, Normally Closed, Always Detected, Alarm Only</p> <p>2E: External fault, Normally Open, During Run, Alarm Only</p> <p>2F: External fault, Normally Closed, During Run, Alarm Only</p> <p>30: PI Integral Reset Resets the PI Integral component to zero when closed</p> <p>31: PI Integral Hold Holds the PI integral value when closed</p> <p>34: PI SFS Cancel (SFS= SoftStart, also called Accel/Decel, See Parameter b5-17)</p> <p>35: PI Input Level Sel Inverts the PI error signal when closed</p> <p>36: Option/Inv Sel 2 Selects source of speed command and sequence Closed = Option Card, Open = b1-01 &amp; b1-02</p> <p>60: Motor Preheat Applies current to create heat to avoid condensation Closed = Apply amount of current as set in parameter b2-09</p>	0 to 6E	4: 2-wire 3: 3-wire	Programming
H1-05	Terminal S7 Function Selection <b>Terminal S7 Sel</b>	<p>61: Speed Search 1 When closed as a run command is given, drive does a speed search starting at maximum frequency (E1-04). (current detection)</p> <p>62: Speed Search 2 When closed as a run command is given, drive does a speed search starting at speed command. (current detection)</p> <p>64: Speed Search 3 When opened, the Drive performs a baseblock (motor coasts). When closed, the Drive performs Speed Search from set frequency.</p> <p>67: Com Test Mode - Used to test RS-485/422 interface.</p> <p>68: High Slip Braking - Closed = Drive stops using High Slip Braking regardless of run command status.</p> <p>69: Jog2 - Closed = Drive runs at speed command entered into parameter d1-17. Direction determined by fwd/rev input. 3-wire control Only.</p> <p>6A: Drive Enable - Closed = Drive will accept run command. Open = Drive will not run. If running, drive will stop per b1-03. Run Command must be cycled</p> <p>6B: Com/Inv Sel - Selects source of Speed Command and Sequence. Closed = Serial Communication (R+,R-,S+,S-), Open = b1-01 &amp; b1-02</p> <p>6C: Com/Inv Sel 2 - Selects source of Speed Command and Sequence. Closed = b1-01 &amp; b1-02, Open = Serial Communication (R+,R-,S+,S-)</p> <p>6D: Auto Mode Sel - Hand/Auto Selection - Closed = Auto, Open = Hand</p> <p>6E: Hand Mode Sel - Hand/Auto Selection - Closed = Hand, Open = Auto</p> <p>70: Bypass/Drv Enbl. Same as 6A except a run command is accepted</p> <p>80: Motor Preheat 2 - Closed = Enable motor preheat with the current level as set by b2-10</p> <p>81: EmergOverrideFWD - Closed = Forward Emergency Override Command</p> <p>82: EmergOverrideREV - Closed = Reverse Emergency Override Command</p>	0 to 6E	6: 2-wire 4: 3-wire	Programming

Table A.1 Parameter List (Continued)

Parameter No.	Parameter Name Digital Operator Display	Description	Setting Range	Factory Setting	Menu Location
<b>Digital Outputs</b>					
H2-01	Terminal M1-M2 Function Selection <b>Term M1-M2 Sel</b>	<p>0: During RUN 1 = Closed when a run command is input or the drive is outputting voltage.</p> <p>1: Zero Speed = Closed when drive output frequency is less than Fmin (E1-09)</p> <p>2: Fref/Fout Agree 1 = Closed when drive output speed equals the speed command within the bandwidth of L4-02.</p> <p>3: Fref/Set Agree 1 = Closed when the drive output speed and the speed command are equal to the value in L4-01 within the bandwidth of L4-02.</p> <p>4: Freq Detect 1 = Closed when the drive output speed is less than or equal to the value in L4-01, with hysteresis determined by L4-02.</p> <p>5: Freq Detect 2 = Closed when the drive output speed is greater than or equal to the value in L4-01, with hysteresis determined by L4-02.</p> <p>6: Inverter Ready = Closed when the drive is not in a fault state, and not in program mode.</p> <p>7: DC Bus Undervolt = Closed when the DC bus voltage falls below the UV trip level (L2-05)</p> <p>8: Base Blk 1 = Closed when the drive is not outputting voltage.</p> <p>9: Operator Reference = Closed when the speed command is coming from the digital operator.</p> <p>A: Remote/Auto Oper = Closed when the run command is coming from the digital operator.</p> <p>B: Trq Det 1 N.O. - Closes when the output current exceeds the value set in parameter L6-02 for more time than is set in parameter L6-03.</p> <p>C: Loss of Ref - Closes when the drive has detected a loss of analog speed command. Speed command is considered lost when it drops 90% in 0.4 seconds. Parameter L4-05 determines drive reaction to a loss of speed command.</p> <p>D: DB Overheat</p> <p>E: Fault - Closes when the drive experiences a major fault.</p> <p>F: Not Used</p> <p>10: Minor Fault - Closes when drive experiences a minor fault or alarm.</p> <p>11: Reset Cmd Active - Closes when the drive receives a reset command from terminals or serial comms.</p> <p>12: Timer Output - Output for independent timer, controlled by b4-01 and b4-02. Used in conjunction with a multi-function digital input.</p> <p>17: Trq. Det 1 N.C. - Opens when the output current exceeds the value set in parameter L6-02 for more time than is set in parameter L6-03.</p> <p>1A: Reverse Dir - Closes when the drive is running in the reverse direction.</p> <p>1E: Restart Enabled - Closes when the drive is performing an automatic restart. Automatic restart is configured by parameter L5-01.</p> <p>1F: Overload (OL1) - Closes before a motor overload occurs. (90% of OL1 time)</p> <p>20: OH Prealarm - Closes when the Drive's heatsink temperature exceeds the setting of parameter L8-02.</p> <p>38: Drive Enable - Closes when the drive enable input is active.</p> <p>39: Waiting to Run - Closes during the time after a run command is issued, but the Drive is not running due to the time set in parameter b1-10.</p> <p>3A: OH Freq Reduce</p> <p>3B: Run Src Com/Opt</p> <p>3D: Cooling Fan Err = Closed during internal cooling fan failure</p>	0 to 3B	0	Programming
H2-02	Terminal M3-M4 Function Selection <b>Term M3-M4 Sel</b>	<p>10: Minor Fault - Closes when drive experiences a minor fault or alarm.</p> <p>11: Reset Cmd Active - Closes when the drive receives a reset command from terminals or serial comms.</p> <p>12: Timer Output - Output for independent timer, controlled by b4-01 and b4-02. Used in conjunction with a multi-function digital input.</p> <p>17: Trq. Det 1 N.C. - Opens when the output current exceeds the value set in parameter L6-02 for more time than is set in parameter L6-03.</p> <p>1A: Reverse Dir - Closes when the drive is running in the reverse direction.</p> <p>1E: Restart Enabled - Closes when the drive is performing an automatic restart. Automatic restart is configured by parameter L5-01.</p> <p>1F: Overload (OL1) - Closes before a motor overload occurs. (90% of OL1 time)</p> <p>20: OH Prealarm - Closes when the Drive's heatsink temperature exceeds the setting of parameter L8-02.</p> <p>38: Drive Enable - Closes when the drive enable input is active.</p> <p>39: Waiting to Run - Closes during the time after a run command is issued, but the Drive is not running due to the time set in parameter b1-10.</p> <p>3A: OH Freq Reduce</p> <p>3B: Run Src Com/Opt</p> <p>3D: Cooling Fan Err = Closed during internal cooling fan failure</p>	0 to 3B	A	Programming

Table A.1 Parameter List (Continued)

Parameter No.	Parameter Name Digital Operator Display	Description	Setting Range	Factory Setting	Menu Location
<b>Analog Inputs</b>					
H3-02 ◆	Terminal A1 Gain Setting <b>Terminal A1 Gain</b>	Sets the speed command when 10V is input, as a percentage of the maximum output frequency (E1-04).	0.0 to 1000.0	100.0%	Programming
H3-03 ◆	Terminal A1 Bias Setting <b>Terminal A1 Bias</b>	Sets the speed command when 0V is input, as a percentage of the maximum output frequency (E1-04).	-100.0 to +100.0	0.0%	Programming
H3-08	Terminal A2 Signal Level Selection <b>Term A2 Signal</b>	Selects the signal level of terminal A2. 0: 0 - 10VDC (switch S1-2 must be in the off position) 2: 4 - 20 mA (switch S1-2 must be in the on position)	0 or 2	2	Programming*
H3-09	Aux Terminal Function Selection <b>Terminal A2 Sel</b>	Selects what effect the Aux terminal (A2) has on the drive. 0: Frequency Bias - 0 - 100% bias 2: Aux Reference B: PI Feedback D: Frequency Bias 2 - 0 - 100% bias E: Motor Temperature - See parameters L1-03 & L1-04 1F: PI Differential 1F: Not Used	0 to 1F	2**	Programming*
H3-10 ◆	Terminal A2 Gain Setting <b>Terminal A2 Gain</b>	Sets the level of the A2 function corresponding to a 10V input (in%).	0.0 to 1000.0	100.0%	Programming
H3-11 ◆	Terminal A2 Bias Setting <b>Terminal A2 Bias</b>	Sets the level of the A2 function corresponding to a 0V input (in%).	-100.0 to +100.0	0.0%	Programming
H3-12	Analog Input Filter Time Constant <b>Filter Avg Time</b>	Used to "smooth" out erratic or noisy analog input signals.	0.00 to 2.00	0.30sec	Programming
H3-13	Master Frequency Reference Terminal Selection <b>TA1/A2 Select</b>	Determines which terminal will be the main reference source. 0: Main Fref TA1 - Terminal TA1 is the main speed command and Terminal TA2 is the Aux speed command. 1: Main Fref TA2 - Terminal TA2 is the main speed command and Terminal TA1 is the Aux speed command. Only effective when H3-09 is set to 2 "Aux Reference".	0 or 1	0	Programming*
<p>◆ Denotes that parameter can be changed when the drive is running.                      * Menu location is Quick Setting when b5-01=1, and Programming when b5-01=0.                      ** Factory setting changes to "B" when b5-01=1.</p>					

Table A.1 Parameter List (Continued)

Parameter No.	Parameter Name Digital Operator Display	Description	Setting Range	Factory Setting	Menu Location
<b>Analog Outputs</b>					
H4-01	Terminal FM Monitor Selection <b>Terminal FM Sel</b>	Selects which monitor will be output on terminals FM and AC. 1: Frequency Ref (100% = max. output frequency) 2: Output Freq (100% = max. output frequency) 3: Output Current (100% = drive rated current) 6: Output Voltage (100% = 230V or 100% = 460V) 7: DC Bus Voltage (100% = 400V or 100% = 800V) 8: Output kWatts (100% = drive rated power) 15: Term A1 Level 16: Term A2 Level 18: Mot SEC Current (100% = Motor rated secondary current) 20: SFS Output (100% = max. output frequency) 24: PI Feedback 31: Not Used 36: PI Input 37: PI Output (100% = max. output frequency) 38: PI Setpoint 51: Auto Mode Fref (100% = max. output frequency) 52: Hand Mode Fref (100% = max. output frequency) 53: PI Feedback 2 NOTE: 100% = 10V DC output * FM gain setting (H4-02).	1 to 53	2	Programming
H4-02 ◆	Terminal FM Gain Setting <b>Terminal FM Gain</b>	Sets terminal FM output voltage (in percent of 10V) when selected monitor is at 100% output.	0.0 to 1000.0	100.0%	Programming
H4-03 ◆	Terminal FM Bias Setting <b>Terminal FM Bias</b>	Sets terminal FM output voltage (in percent of 10V) when selected monitor is at 0% output.	-110.0 to 110.0	0.0%	Programming
H4-04	Terminal AM Monitor Selection <b>Terminal AM Sel</b>	Selects which monitor will be output on terminals AM and AC. 1: Frequency Ref (100% = max. output frequency) 2: Output Freq (100% = max. output frequency) 3: Output Current (100% = drive rated current) 6: Output Voltage (100% = 230V or 100% = 460V) 7: DC Bus Voltage (100% = 400V or 100% = 800V) 8: Output kWatts (100% = drive rated power) 15: Term A1 Level 16: Term A2 Level 18: Mot SEC Current (100% = Motor rated secondary current) 20: SFS Output (100% = max. output frequency) 24: PI Feedback 31: Not Used 36: PI Input 37: PI Output (100% = max. output frequency) 38: PI Setpoint 51: Auto Mode Fref (100% = max. output frequency) 52: Hand Mode Fref (100% = max. output frequency) 53: PI Feedback 2 NOTE: 100% = 10V DC output * AM gain setting (H4-05).	1 to 53	8	Programming
H4-05 ◆	Terminal AM Gain Setting <b>Terminal AM Gain</b>	Sets terminal AM output voltage (in percent of 10V) when selected monitor is at 100% output.	0.0 to 1000.0	50.0%	Programming
◆Denotes that parameter can be changed when the drive is running.					

Table A.1 Parameter List (Continued)

Parameter No.	Parameter Name Digital Operator Display	Description	Setting Range	Factory Setting	Menu Location
			<b>Analog Outputs</b>		
H4-06 ◆	Terminal AM Bias Setting <b>Terminal AM Bias</b>	Sets terminal AM output voltage (in percent of 10V) when selected monitor is at 0% output.	-110.0 to 110.0	0.0%	Programming
H4-07	Terminal FM Signal Level Selection <b>AO Level Select1</b>	0: 0 - 10 VDC 2: 4-20 mA*	0 or 2	0	Programming
H4-08	Terminal AM Signal Level Selection <b>AO Level Select2</b>	0: 0 - 10 VDC 2: 4-20 mA* * An analog output of 4 - 20 mA can not be used with the standard terminal board. Therefore an optional terminal board (with shunt connector CN15) is needed.	0 or 2	0	Programming
			<b>Serial Com Setup</b>		
H5-01	Drive Node Address <b>Serial Comm Adr</b>	Selects drive station node number (address) for terminals R+, R-, S+, S-.* An address of "0" disables serial com.	0 to 20 (H5-08=0) 0 to FF (H5-08=1) 0 to 63 (H5-08=2)	1F #	Programming
H5-02	Communication Speed Selection <b>Serial Baud Rate</b>	Selects the baud rate for terminals R+, R-, S+ and S-.* 0: 1200 Baud 1: 2400 Baud 2: 4800 Baud (APOGEE FLN) 3: 9600 Baud (Metasys N2) 4: 19200 Baud	0 to 4	3	Programming
H5-03	Communication Parity Selection <b>Serial Com Sel</b>	Selects the communication parity for terminals R+, R-, S+ and S-.* 0: No Parity 1: Even Parity 2: Odd Parity	0 to 2	0	Programming
H5-04	Stopping Method after Communication Error <b>Serial Fault Sel</b>	Selects the stopping method when a communication error is detected. 0: Ramp to Stop 1: Coast to Stop 2: Fast-Stop 3: Alarm Only 4: Run at d1-04 - available when H5-08="1: N2 METASYS" or "2: FLN APOGEE"	0 to 3	3	Programming
H5-05	Communication Error Detection Selection <b>Serial Flt Dctt</b>	Enables or disables the communications timeout detection function. 0: Disabled - A communications loss will NOT cause a communications fault. 1: Enabled - If communications are lost for more than the time specified in parameter H5-09, a communications fault will occur.	0 or 1	1	Programming
H5-06	Drive Transmit Wait Time <b>Transmit WaitTIM</b>	Sets the time from when the drive receives data to when the drive sends data.	5 to 65	5ms	Programming
H5-07	RTS Control Selection <b>RTS Control Sel</b>	Enables or disables "request to send" (RTS) control: 0: Disabled (RTS is always on) 1: Enabled (RTS turns on only when sending)	0 or 1	1	Programming
H5-08	Communication Protocol Selection <b>Protocol Select</b>	Selects the communication protocol. 0: Memobus (Modbus) 1: N2 (Metasys) 2: FLN (APOGEE)	0 to 2	0	Programming
H5-09	Communication Error Detection Time <b>CE Detect Time</b>	Determines how long communications must be lost before a fault is annunciated. Works in conjunction with parameters H5-05 and H5-04.	0 to 10.0 (H5-08=0) 0 to 10.0 (H5-08=1) 0 to 90.0 (H5-08=2)	2.0sec	Programming

◆Denotes that parameter can be changed when the drive is running.

\* After these parameters are changed, drive power must be cycled before the changes will take effect.

# Hex, see page A-30.

Table A.1 Parameter List (Continued)

Parameter No.	Parameter Name Digital Operator Display	Description	Setting Range	Factory Setting	Menu Location
<b>Motor Overload</b>					
L1-01	Motor Overload Protection Selection <b>MOL Fault Select</b>	Enables or disables the motor thermal overload protection. 0: Disabled 1: Std Fan Cooled (Enabled) 2: Std Blower Cooled 3: Vector Motor	0 to 1	1	Programming
L1-02	Motor Overload Protection Time <b>MOL Time Const</b>	Determines how much time will elapse prior to a motor overload fault (OL1), when motor amps exceed the value set in parameter E2-01 by 10%. Actual (OL1) trip time will vary depending on severity of overload.	0.1 to 20.0	8.0min	Programming
L1-03	Motor Overheat Alarm Operation Selection <b>Mtr OH Alarm Sel</b>	Operation selection when the motor temperature analog input (H3-09=E) exceeds the OH3 alarm level (1.17V) 0: Ramp to Stop 1: Coast to Stop 2: Fast-Stop 3: Alarm Only	0 to 3	3	Programming
L1-04	Motor Overheat Fault Operation Selection <b>Mtr OH Fault Sel</b>	Stopping method when the motor temperature analog input (H3-09=E) exceeds the OH4 level (2.34V). 0: Ramp to Stop 1: Coast to Stop 2: Fast-Stop	0 to 2	1	Programming
L1-05	Motor Temperature Input Filter Time <b>Mtr Temp Filter</b>	Delay Time applied to motor temperature analog input (H3-09=E) for filtering purposes.	0.00 to 10.00	0.20sec	Programming
<b>PwrLoss Ridethru</b>					
L2-01	Momentary Power Loss Detection Selection <b>PwrL Selection</b>	Enables and disables the momentary power loss function. 0: Disabled - Drive trips on (UV1) fault when power is lost. 1: PwrL Ride Thru t - Drive will restart if power returns within the time set in L2-02.* 2: CPU Power Active - Drive will restart if power returns prior to internal power supply shut down.* * In order for a restart to occur, the run command must be maintained throughout the ride thru period.	0 to 2	2	Programming
L2-02	Momentary Power Loss Ride-thru Time <b>PwrL Ridethru t</b>	Determines the power loss ride-thru time. This value is dependent on the capacity of the drive. Only effective when L2-01 = 1.	0.0 to 25.5sec	kVA Dependent	Programming
L2-03	Momentary Power Loss Minimum Base Block Time <b>PwrL Baseblock t</b>	Used to allow the residual motor voltage to decay before the drive output turns back on. After a power loss, if L2-03 is greater than L2-02, operation resumes after the time set in L2-03.	0.1 to 5.0sec	kVA Dependent	Programming
L2-04	Momentary Power Loss Voltage Recovery Ramp Time <b>PwrL V/F Ramp t</b>	The time it takes the output voltage to return to the preset V/f pattern after speed search (current detection mode) is complete.	0.0 to 5.0sec	kVA Dependent	Programming
L2-05	Undervoltage Detection Level <b>PUV Det Level</b>	Sets the drive's DC Bus undervoltage trip level. If this is set lower than the factory setting, additional AC input reactance or DC bus reactance may be necessary.	Voltage Class Dependent	Voltage Class Dependent	Programming

Table A.1 Parameter List (Continued)

Parameter No.	Parameter Name Digital Operator Display	Description	Setting Range	Factory Setting	Menu Location
<b>Stall Prevention</b>					
L3-01	Stall Prevention Selection During Accel <b>StallP Accel Sel</b>	<p>0: Disabled (Motor accelerates at active acceleration, C1-01 or C1-03. The motor may stall if load is too heavy or accel time is too short).</p> <p>1: General Purpose (When output current exceeds L3-02 level, acceleration stops. It starts to accelerate at current value recovery).</p> <p>2: Intelligent (The active acceleration rate, C1-01 or C1-02, is ignored. Acceleration is completed in the shortest amount of time w/o exceeding the current value set in L3-02).</p>	0 to 2	1	Programming
L3-02	Stall Prevention Level During Accel <b>StallP Accel Lvl</b>	<p>This function is enabled when L3-01 is "1" or "2". Drive rated current is 100%. Decrease the set value if stalling occurs at factory setting.</p>	0 to 200	120%	Programming
L3-04	Stall Prevention Selection During Decel <b>StallP Decel Sel</b>	<p>0: Disabled (The drive decelerates at the active deceleration rate, C1-02 or C1-04. If the load is too large or the deceleration time is too short, an OV fault may occur).</p> <p>1: General Purpose (The drive decelerates at the active deceleration rate, C1-02 or C1-04, but if the main circuit DC bus voltage reaches the stall prevention level the output frequency will clamp. Deceleration will continue once the DC bus level drops below the stall prevention level).</p> <p>2: Intelligent (The active deceleration rate is ignored and the drive decelerates as fast as possible w/o hitting OV fault level).</p>	0 to 3	1	Programming
L3-05	Stall Prevention Selection During Run <b>StallP Run Sel</b>	<p>0: Disabled (Drive runs a set frequency). A heavy load may cause the drive to trip on an OC fault.</p> <p>1: Decel Time 1 (In order to avoid stalling during heavy loading, the drive will start to decelerate at Decel time 1 (C1-02) if the output current exceeds the level set by L3-06. Once the current level drops below the L3-06 level the drive will accelerate back to its set frequency at the active acceleration rate).</p> <p>2: Decel Time 2 (Same as setting 1 except the drive decelerates at Decel Time 2 (C1-04). For 6Hz or less frequency, stall prevention function during run is disabled regardless of L3-05 set.</p>	0 to 2	1	Programming
L3-06	Stall Prevention Level During Running <b>StallP Run Level</b>	<p>This function is enabled when L3-05 is "1" or "2". Drive rated current is set as 100%. Normally, changing the setting is not required. Decrease the set value if stalling occurs at factory setting.</p>	30 to 200	120%	Programming

Table A.1 Parameter List (Continued)

Parameter No.	Parameter Name Digital Operator Display	Description	Setting Range	Factory Setting	Menu Location
<b>Ref Detection</b>					
L4-01	Speed Agreement Detection Level <b>Spd Agree Level</b>	L4-01 and L4-02 are used in conjunction with the multi-function outputs, (H2-01 and H2-02) as a setpoint and hysteresis for a contact closure.	0.0 to 200.0	0.0Hz	Programming
L4-02	Speed Agreement Detection Width <b>Spd Agree Width</b>		0.0 to 20.0	2.0Hz	Programming
L4-05	Frequency Reference Loss Detection Selection <b>Ref Loss Sel</b>	Determines how the drive will react when the frequency reference is lost. 0: Stop (Disabled) - Drive will not run at the frequency reference 1: Enabled @ % of PrevRef - Drive will run at a percentage (L4-06) of the frequency reference level at the time frequency reference was lost.	0 or 1	1	Programming
L4-06	Frequency Reference Level at Loss Frequency <b>Fref at Floss</b>	If Frequency Reference loss function is enabled (L4-05=1) and Frequency Reference is lost, then the drive will run at reduced frequency reference determined by L4-06. New Fref = Fref at time of loss x L4-06.	0 to 100.0%	80.0%	Programming
<b>Fault Restart</b>					
L5-01	Number of Auto Restart Attempts <b>Num of Restarts</b>	Determines the number of times the drive will perform an automatic restart.	0 to 10	0	Quick Setting
L5-02	Auto Restart Operation Selection <b>Restart Sel</b>	Determines if the fault contact activates during an automatic restart attempt. 0: No Flt Relay - fault contact will not activate during an automatic restart. 1: Flt Relay Active - fault contact will activate during an automatic restart.	0 or 1	0	Programming
L5-03	Maximum Restart Time After Fault <b>Max Restart Time</b>	If the restart fails (or is not attempted due to a continuing fault condition, e.g. an OV fault) the Drive waits L5-03 seconds before attempting another restart.	0.5 to 600.0	180.0sec	Quick Setting
<b>Torque Detection</b>					
L6-01	Torque Detection Selection 1 <b>Load Detection</b>	Determines the drive's response to an overtorque / undertorque condition. Overtorque and Undertorque are determined by the settings in parameters L6-02 and L6-03. 0: Disabled 1: OL@SpdAgree - Alm (Overtorque Detection only active during Speed Agree and Operation continues after detection). 2: OL At RUN - Alm (Overtorque Detection is always active and operation continues after detection) 3: OL@SpdAgree - Flt (Overtorque Detection only active during Speed Agree and drive output will shut down on an OL3 fault). 4: OL At RUN - Flt (Overtorque Detection is always active and drive output will shut down on an OL3 fault). 5: LL@SpdAgree - Alm (Undertorque Detection is only active during Speed Agree and operation continues after detection). 6: LL at RUN - Alm (Undertorque Detection is always active and operation continues after detection) 7: LL @ SpdAgree - Flt (Undertorque Detection only active during Speed Agree and drive output will shut down on an OL3 fault). 8: LL At RUN - Flt (Undertorque Detection is always active and drive output will shut down on an OL3 fault).	0 to 8	0	Programming
L6-02	Torque Detection Level 1 <b>Load Det Lvl</b>	Sets the overtorque/undertorque detection level as a percentage of Drive rated current.	0 to 300	15%	Programming
L6-03	Torque Detection Time 1 <b>Loss Det Time</b>	Sets the length of time an overtorque / undertorque condition must exist before being recognized by the drive. OL3 is then displayed.	0.0 to 10.0	10.0sec	Programming

Table A.1 Parameter List (Continued)

Parameter No.	Parameter Name Digital Operator Display	Description	Setting Range	Factory Setting	Menu Location
<b>Hdwe Protection</b>					
L8-01	Internal Dynamic Braking Resistor Protection Selection <b>DB Resistor Prot</b>	0: Not Provided 1: Provided	0 or 1	0	Programming
L8-02	Overheat Pre-Alarm Level <b>OH Pre-Alarm Lvl</b>	When the cooling fin temperature exceeds the value set in this parameter, an overheat pre-alarm (OH) will occur.	50 to 130	kVA Dependent	Programming
L8-03	Overheat Pre-Alarm Operation Selection <b>OH Pre-Alarm Sel</b>	Drive Operation upon OH Pre Alarm Detection. 0: Ramp to Stop (Decel Time C1-02). 1: Coast to Stop 2: Fast-Stop (Decel Time = C1-09). 3: Alarm Only *0 to 2 is recognized as fault detection, and 3 is recognized as alarm. (For the fault detection, the fault contact operates.) 4: OH Alarm & Reduce (Continue operation and reduce output frequency by L8-19).	0 to 4	4	Programming
L8-06	Input Phase Loss Detection Level <b>Ph Loss In Lvl</b>	Monitors the DC Bus current ripple and activates when one of the input phases is lost (PF).	0.0 to 25.0	kVA Dependent	Programming
L8-09	Output Ground Fault Detection Selection <b>Ground Fault Sel</b>	Enables and disables drive output ground fault detection. 0: Disabled 1: Enabled	0 or 1	1	Programming
L8-10	Heatsink Cooling Fan Operation Selection <b>Fan On/Off Sel</b>	Controls the Heatsink Cooling Fan Operation. 0: Fan On-Run Mode (Fan will operate only when drive is running and for L8-11 seconds after RUN is removed). 1: Fan Always On (Cooling fan operates whenever drive is powered up).	0 or 1	0	Programming
L8-11	Heatsink Cooling Fan Operation Delay Time <b>Fan Delay Time</b>	When L8-10=0 this parameter sets a delay time for Cooling Fan de-energization after the run command is removed.	0 to 300	300sec	Programming
L8-12	Ambient Temperature Setting <b>Ambient Temp</b>	When the drive is installed in an ambient temperature exceeding its rating, drive overload (OL2) protection level is reduced.	45 to 60°C	45°C	Programming
L8-15	OL2 Characteristic Selection at Low Speeds <b>OL2 Sel @ L-Spd</b>	This parameter assists in protecting the output transistor junctions from overheating when output current is high and output frequency is low. 0: Disabled 1: Enabled (L8-18 is active)	0 or 1	1	Programming
L8-18	Soft CLA Selection <b>Soft CLA Sel</b>	Enables and disables software Current Limit "A" (CLA) 0: Disabled 1: Enabled	0 or 1	1	Programming
L8-19	OH Frequency Reference Reduction Level <b>Fref During OH</b>	Sets the amount of frequency reference reduction when an Overheat Pre-alarm (OH) is detected.	0.0 to 100.0	20.0%	Programming
L8-32	OH1 Detection Selection for Fan Failure <b>OH1 Detect Sel</b>	Selects the drive response upon failure of the internal cooling fan. 0: Disabled FAN alarm is displayed 1: Enabled OH1 fault occurs	0 or 1	1	Programming

Table A.1 Parameter List (Continued)

Parameter No.	Parameter Name Digital Operator Display	Description	Setting Range	Factory Setting	Menu Location								
<b>Hunting Prev</b>													
n1-01	Hunting Prevention Selection <b>Hunt Prev Select</b>	0: Disabled (Hunting prevention function disabled). 1: Enabled (Hunting prevention function enabled). If the motor vibrates while lightly loaded, hunting prevention may reduce the vibration. There is a loss of responsiveness if hunting prevention is enabled.	0 or 1	1	Programming								
n1-02	Hunting Prevention Gain Setting <b>Hunt Prev Gain</b>	Gain setting for the Hunting Prevention Function. If the motor vibrates while lightly loaded and n1-01=1, increase the gain by 0.1 until vibration ceases. If the motor stalls while n1-01=1 decrease the gain by 0.1 until the stalling ceases.	0.00 to 2.50	1.00	Programming								
<b>High Slip</b>													
n3-01	High-Slip Braking Deceleration Frequency Width <b>HSB Decel Width</b>	Sets how aggressively the drive decreases the output frequency as it stops the motor. If overvoltage (OV) faults occur during HSB, this parameter may need to be increased.	1 to 20	5%	Programming								
n3-02	High-Slip Braking Current Limit <b>HSB Current Ref</b>	Sets the maximum current to be drawn during a HSB stop. Higher n3-02 settings will shorten motor stopping times but cause increased motor current, and therefore increased motor heating.	100 to 200	150%	Programming								
n3-03	High-Slip Braking Dwell Time at Stop <b>HSB DwellTim@ Stp</b>	Sets the amount of time the Drive will dwell at E1-09 (Minimum Frequency). If this time is set too low, the machine inertia can cause the motor to rotate slightly after the HSB stop is complete and the Drive output is shut off.	0.0 to 10.0	1.0sec	Programming								
n3-04	High-Slip Braking Overload Time <b>HSB OL Time</b>	Sets the time required for a HSB Overload Fault to occur when the Drive output frequency does not change for some reason during a HSB stop. Normally this does not need to be adjusted.	30 to 1200	40sec	Programming								
<b>Monitor Select</b>													
o1-01 ◆	User Monitor Selection <b>User Monitor Sel</b>	Selects which monitor will be displayed upon power-up when o1-02 = 4.	6 to 53	6	Programming								
o1-02	User Monitor Selection After Power-Up <b>Power-On Monitor</b>	Selects which monitor will be displayed upon power-up. 1: Frequency Ref 2: Output Freq 3: Output Current 4: User Monitor (set by o1-01)	1 to 4	1**	Programming								
o1-03	Digital Operator Display Selection <b>Display Scaling</b>	Sets the units of the Frequency References (d1-01 through d1-17) and the Frequency Reference Monitor (U1-01). 0: Hz 1: % (100%. = E1-04) 2 to 39: RPM. (Enter the number of motor poles.) 40 to 39999: User display Desired set/display value is set at Max. output frequency. 4 digit number. The number of digits from the right the decimal point is displayed.  Example: If "200.0 is displayed at Max. output frequency, set "12000". When o1-03≥40 (user units), the unit selected in o1-09 will be displayed for D1-01 to D1-17, U1-01, U1-02, and U1-20	0 to 39999	0	Programming								
o1-05	LCD Brightness Adjustment <b>LCD Contrast</b>	<table border="1" style="width: 100%; border-collapse: collapse;"> <thead> <tr> <th>Set Value</th> <th>Description</th> </tr> </thead> <tbody> <tr> <td>5</td> <td>LCD display becomes dark</td> </tr> <tr> <td>3</td> <td>Standard setting</td> </tr> <tr> <td>1</td> <td>LCD display becomes light</td> </tr> </tbody> </table>	Set Value	Description	5	LCD display becomes dark	3	Standard setting	1	LCD display becomes light	0 to 5	3	Programming
Set Value	Description												
5	LCD display becomes dark												
3	Standard setting												
1	LCD display becomes light												

\*\* Factory setting changes to "2" when b5-01=1

Table A.1 Parameter List (Continued)

Parameter No.	Parameter Name Digital Operator Display	Description	Setting Range	Factory Setting	Menu Location
o1-06	User Monitor Selection Mode <b>Monitor Mode Sel</b>	Selects the "U1" monitors displayed on the 4th and 5th lines of the digital operator display. 0: 3 Mon Sequential (Displays the next 2 sequential U1 monitors). 1: 3 Mon Selectable (Displays U1 monitors set by o1-07 and o1-08).	0 or 1	0**	Programming
o1-07	Second Line User Monitor Selection <b>2nd Monitor Sel</b>	Sets the "U1" monitor always displayed on the 4th line of the digital operator display. Effective only when o1-06 = 1.	1 to 53	2**	Programming
o1-08	Third Line User Monitor Selection <b>3rd Monitor Sel</b>	Sets the "U1" monitor always displayed on the 5th line of the digital operator display. Effective only when o1-06 = 1.	1 to 53	3**	Programming
o1-09 ◆	Frequency Reference Display Units <b>Frq Display Unit</b>	Sets unit display for the frequency reference parameters and frequency related monitors when o1-03≥40. 0: WC:InchOfWater 1: PSI:lb/SqrInch 2: GPM:Gallons/Min 3: F:DegFahrenheit 4: CFM:Cubic ft/Min 5: CMH:Cubic M/Hr 6: LPH:Liters/Hr 7: LPS:Liters/Sec 8: Bar:Bar 9: Pa:Pascals 10: C:DegCelsius 11: Mtr:Meters	0 to 11	0	Programming
<b>Key Selections</b>					
o2-01	Local/Remote Key Function Selection <b>Local/Remote Key</b>	Determines the status of the Local/Remote key, if present. 0: Disabled 1: Enabled Has no function when H/O/A operator is connected.	0 or 1	1	Programming
o2-02	OFF Key Function During Auto Run <b>Oper OFF Key</b>	Determines if the off key on the digital operator will stop the drive when drive is operating from external terminals or serial communications. 0: Disabled 1: Enabled	0 or 1	1	Programming
o2-03	User Parameter Default Value <b>User Defaults</b>	Allows storing of current parameter values as a User Initialization Selection at parameter A1-03. 0: No Change (No user parameter set active). 1: Set Defaults (Saves current parameter settings as user initialization. A1-03 now allows selecting <1110> for user initialization. 2: Clear All (Clears the currently saved user initialization. A1-03 no longer allows selecting <1110>.	0 to 2	0	Programming
o2-04	Drive/kVA Selection <b>Inverter Model #</b>	Sets the kVA of the drive. Enter the number based on drive Model #. Use the □□□□ portion of the CIMR-E7□□□□ Model Number. Reference Appendix B	0 to FF	kVA Dependent	Programming
o2-05	Frequency Reference Setting Method Selection <b>Operator M.O.P.</b>	Determines if the Data/Enter key must be used to input a frequency reference from the digital operator. 0: Disabled - Data/Enter key must be pressed to enter a frequency reference. 1: Enabled - Data/Enter key is not required. The frequency reference is adjusted by the up and down arrow keys on the digital operator without having to press the data/enter key.	0 or 1	1	Programming
o2-06	Operation Selection when Digital Operator is Disconnected <b>Oper Detection</b>	Determines if the drive will stop when the digital operator is removed. 0: Disabled - The drive will not stop when the digital operator is removed. 1: Enabled - The drive will fault (OPR) and coast to stop when the operator is removed.	0 or 1	1	Programming
o2-07	Cumulative Operation Time Setting <b>Elapsed Time Set</b>	Sets the initial value of the elapsed operation timer.	0 to 65535	0 hours	Programming
◆ Denotes that parameter can be changed when the drive is running. ** Factory settings change when b5-01=1 as follows: o1-06=1, o1-07=38, o1-08=24.					

Table A.1 Parameter List (Continued)

Parameter No.	Parameter Name Digital Operator Display	Description	Setting Range	Factory Setting	Menu Location
o2-08	Cumulative Operation Time Selection <b>Elapsed Time Run</b>	Sets how time is accumulated for the elapsed timer (o2-07). 0: Power-On Time (Time accumulates whenever drive is powered) 1: Running Time (Time accumulates only when drive is running)	0 or 1	1	Programming
o2-09	Initialization Specification Selection <b>Init Mode Sel</b>	Determines parameter values after a drive initialization (A1-03) is executed. This should always be set to "1" American Spec. 1: American spec 2: European spec 4: PV-A spec 5: PV-E spec 6: Chinese spec	1 to 5	1	Programming
o2-10	Cumulative Cooling Fan Operation Time Setting <b>Fan ON Time Set</b>	Sets the initial value of the heatsink fan operation time.	0 to 65535	0 hours	Programming
o2-12	Fault Trace/Fault History Clear Function <b>FLT Trace Init</b>	Clears the fault memory contained in the U2 and U3 monitors. 0: Disabled (no effect) 1: Enabled - resets U2 and U3 monitors, and returns o2-12 to zero	0 or 1	0	Programming
o2-14	kWh User Monitor (U1-29) Initialization <b>kWh Monitor Clear</b>	Used to reset the kilowatt Hour monitor to zero 0: Disabled (no change) 1: Clear all - Resets U1-29 to zero and returns o2-14 to zero.	0 or 1	0	Programming
o2-15	Hand Key Function Selection <b>Oper Hand Key</b>	Enables or disables the "Hand" key on the digital operator. 0: Disabled 1: Enabled	0 or 1	1	Programming
<b>COPY Function</b>					
o3-01	Copy Function Selection <b>Copy Function Sel</b>	This parameter controls the copying of parameters to and from the digital operator. 0: COPY SELECT (no function) 1: INV -> OP READ - All parameters are copied from the drive to the digital operator. 2: OP -> INV WRITE - All parameters are copied from the digital operator into the drive. 3: OP<->INV VERIFY - Parameter settings in the drive are compared to those in the digital operator. NOTE: When using the copy function, the drive model number and software number (U1-14) must match or an error will occur.	0 to 3	0	Programming
o3-02	Read Allowed Selection <b>Read Allowable</b>	Enables and disables all digital operator copy functions. 0: Disabled - No digital operator copy functions are allowed 1: Enabled - Copying allowed	0 to 1	0	Programming
<b>Auto-Tuning</b>					
T1-02	Motor Rated Power <b>Mtr Rated Power</b>	Sets the motor rated power in kW. NOTE: T1-02 should be left at the Drive default (the last 3 digits of the Drive model number).	0.00 to 650.00	kVA Dependent	Auto-Tuning
T1-04	Motor Rated Current <b>Rated Current</b>	Sets the motor rated current. (Used only during an auto-tune).	kVA Dependent	kVA Dependent	Auto-Tuning

# Monitor List

Table A.2 Monitor List

Parameter No.	Parameter Name Digital Operator Display	Description
<b>Monitor</b>		
U1-01	Frequency Reference <b>Frequency Ref</b>	Frequency reference (speed command) monitor when in auto mode, frequency reference (speed command) setting location when in hand mode. Units changeable via o1-03.
U1-02	Output Frequency <b>Output Freq</b>	Output frequency (speed) monitor. Units changeable via o1-03.
U1-03	Output Current <b>Output Current</b>	Output current monitor
U1-06	Output Voltage <b>Output Voltage</b>	Displays Drive output voltage
U1-07	DC Bus Voltage <b>DC Bus Voltage</b>	Displays DC Bus Voltage
U1-08	Output Power <b>Output kWatts</b>	Displays Drive output power
U1-10	Input Terminal Status <b>Input Term Sts</b>	<p>Displays Drive input terminal status</p>
U1-11	Output Terminal Status <b>Output Term Sts</b>	<p>Output terminal ON/OFF Check</p>
U1-12	Drive Operation Status <b>Int Ctl Sts 1</b>	

Table A.2 Monitor List (Continued)

Parameter No.	Parameter Name Digital Operator Display	Description
<b>Monitor</b>		
U1-13	Cumulative Operation Time <b>Elapsed Time</b>	Displays total operating or power-on time of the Drive.
U1-14	Software Number <b>FLASH ID</b>	Displays Drive's software number.
U1-15	Terminal A1 Input Voltage <b>Term A1 Level</b>	Displays the input voltage on Terminal A1, as a percentage of 10V DC.
U1-16	Terminal A2 Input Voltage <b>Term A2 level</b>	Displays the input current (or voltage) on Terminal A2, as a percentage of 20mA (or 10 V DC).
U1-18	Motor Secondary Current (I <sub>q</sub> ) <b>Mot SEC Current</b>	Displays the amount of current being used by the motor to produce torque (I <sub>q</sub> ).
U1-20	Output Frequency After Soft Start <b>SFS Output</b>	Displays the frequency reference (speed command) after the accel and decel ramps.
U1-24	PI Feedback Value <b>PI Feedback</b>	Displays the feedback signal when PI control is used.*
U1-28	CPU Number <b>CPU ID</b>	Displays control board hardware revision.
U1-29	kWh <b>kWh Lo 4 Digits</b>	Displays the accumulated kWh.
U1-30	MWh <b>kWh Hi 5 Digits</b>	Displays the accumulated MWh.
U1-34	First Parameter Causing an OPE <b>OPE Detected</b>	Displays the parameter number causing an "OPE" fault.
U1-36	PI Input <b>PI Input</b>	Displays the "error" in the PI regulator. (U1-36 = PI Setpoint - PI Feedback).
U1-37	PI Output <b>PI Output</b>	Displays the output of the PI as a percentage of maximum frequency (E1-04).
U1-38	PI Setpoint <b>PI Setpoint</b>	Displays the setpoint of the PI regulator (U1-38 = PI reference + PI bias).*
U1-39	Memobus Communication Error Code <b>Transmit Err</b>	
U1-40	Heatsink Cooling Fan Operation Time <b>FAN Elapsed Time</b>	Displays total operating time of the heatsink cooling fan.
U1-51	Auto Mode Frequency Reference Value <b>AUTO Mode Fref</b>	Displays the frequency reference (speed command) when in auto mode.
U1-52	Hand Mode Frequency Reference Value <b>HAND Mode Fref</b>	Displays the frequency reference (speed command) when in hand mode, or displays Terminal A2 when differential mode is selected.
U1-53	PI Feedback 2 Value <b>PI Feedback 2</b>	Displays PI feedback 2 value.

\*\* Units depend on b5-31 setting; scaling is set by b5-20

# Fault Trace List

Table A.3 Fault Trace List

Fault Trace	
U2-01	Current Fault <b>Current Fault</b>
U2-02	Previous Fault <b>Last Fault</b>
U2-03	Frequency Reference at Most Recent Fault <b>Frequency Ref</b>
U2-04	Output Frequency at Most Recent Fault <b>Output Freq</b>
U2-05	Output Current at Most Recent Fault <b>Output Current</b>
U2-07	Output Voltage at Most Recent Fault <b>Output Voltage</b>
U2-08	DC Bus Voltage at Most Recent Fault <b>DC Bus Voltage</b>
U2-09	Output Power at Most Recent Fault <b>Output kWatts</b>
U2-11	Input Terminal Status at Most Recent Fault. The format is the same as for U1-10. <b>Input Term Sts</b>
U2-12	Output Terminal Status at Most Recent Fault. The format is the same as for U1-11. <b>Output Term Sts</b>
U2-13	Drive Operation Status at Most Recent Fault. The format is the same as for U1-12. <b>Inverter Status</b>
U2-14	Cumulative Operation Time at Most Recent Fault <b>Elapsed time</b>
(Note) Fault trace is not executed at CPF00, CPF01, CPF03, UVI and UV2.	

# Fault History List

Table A.4 Fault History List

<b>Fault History</b>	
U3-01	Most Recent Fault <b>Last Fault</b>
U3-02	2 <sup>nd</sup> Most Recent Fault <b>Fault Message 2</b>
U3-03	3 <sup>rd</sup> Most Recent Fault <b>Fault Message 3</b>
U3-04	4 <sup>th</sup> Most Recent Fault <b>Fault Message 4</b>
U3-05	Cumulative Operation Time at Most Recent Fault <b>Elapsed Time 1</b>
U3-06	Cumulative Operation Time at 2 <sup>nd</sup> Most Recent Fault <b>Elapsed Time 2</b>
U3-07	Cumulative Operation Time at 3 <sup>rd</sup> Most Recent Fault <b>Elapsed Time 3</b>
U3-08	Cumulative Operation Time at 4 <sup>th</sup> Most Recent Fault <b>Elapsed Time 4</b>
U3-09	5 <sup>th</sup> Most Recent Fault <b>Fault Message 5</b>
U3-10	6 <sup>th</sup> Most Recent Fault <b>Fault Message 6</b>
U3-11	7 <sup>th</sup> Most Recent Fault <b>Fault Message 7</b>
U3-12	8 <sup>th</sup> Most Recent Fault <b>Fault Message 8</b>
U3-13	9 <sup>th</sup> Most Recent Fault <b>Fault Message 9</b>
U3-14	10 <sup>th</sup> Most Recent Fault <b>Fault Message 10</b>
U3-15	Cumulative Operation Time at 5 <sup>th</sup> Most Recent Fault <b>Elapsed Time 5</b>
U3-16	Cumulative Operation Time at 6 <sup>th</sup> Most Recent Fault <b>Elapsed Time 6</b>
U3-17	Cumulative Operation Time at 7 <sup>th</sup> Most Recent Fault <b>Elapsed Time 7</b>
U3-18	Cumulative Operation Time at 8 <sup>th</sup> Most Recent Fault <b>Elapsed Time 8</b>
U3-19	Cumulative Operation Time at 9 <sup>th</sup> Most Recent Fault <b>Elapsed Time 9</b>
U3-20	Cumulative Operation Time at 10 <sup>th</sup> Most Recent Fault <b>Elapsed Time 10</b>
(Note) Faults such as CPF00, CPF01, CPF02, CPF03, UV1, and UV02 are not stored in fault history.	

# Decimal to Hex Conversion:

Decimal	Hex	Decimal	Hex
1	1	51	33
2	2	52	34
3	3	53	35
4	4	54	36
5	5	55	37
6	6	56	38
7	7	57	39
8	8	58	3A
9	9	59	3B
10	A	60	3C
11	B	61	3D
12	C	62	3E
13	D	63	3F
14	E	64	40
15	F	65	41
16	10	66	42
17	11	67	43
18	12	68	44
19	13	69	45
20	14	70	46
21	15	71	47
22	16	72	48
23	17	73	49
24	18	74	4A
25	19	75	4B
26	1A	76	4C
27	1B	77	4D
28	1C	78	4E
29	1D	79	4F
30	1E	80	50
31	1F	81	51
32	20	82	52
33	21	83	53
34	22	84	54
35	23	85	55
36	24	86	56
37	25	87	57
38	26	88	58
39	27	89	59
40	28	90	5A
41	29	91	5B
42	2A	92	5C
43	2B	93	5D
44	2C	94	5E
45	2D	95	5F
46	2E	96	60
47	2F	97	61
48	30	98	62
49	31	99	63
50	32	100	64

# Appendix B

## Capacity Related Parameters

---

*This appendix lists the parameters affected by the Drive Capacity setting of o2-04.*

Drive Capacity .....	B-2
Parameters Affected by o2-04 .....	B-3
Capacity Related Parameter Values .....	B-4

# Drive Capacity

Parameter o2-04 sets the Drive capacity according to the model number. Parameter o2-04 will need to be adjusted when replacing a control board.

If a Control PCB is changed, the first time the Drive is powered up, parameter o2-04 must be set to the appropriate value listed in *Table B.1* for the Drive model number. After properly setting parameter 02-04, a 2-wire or 3-wire initialization must be performed by setting parameter A1-03=2220 or A1-03=3330, respectively. This will automatically program the values of all other parameters listed in *Table B.2* to the factory settings for that particular Drive rating.

Table B.1 Drive Capacity Selection			
Voltage	Model Number	o2-04 Setting	Nominal Hp
208-240VAC	CIMR-E7U20P4	0	0.5/0.75
	CIMR-E7U20P7	1	1
	CIMR-E7U21P5	2	1.5/2
	CIMR-E7U22P2	3	3
	CIMR-E7U23P7	4	5
	CIMR-E7U25P5	5	7.5
	CIMR-E7U27P5	6	10
	CIMR-E7U2011	7	15
	CIMR-E7U2015	8	20
	CIMR-E7U2018	9	25
	CIMR-E7U2022	A	30
	CIMR-E7U2030	B	40
208-230VAC	CIMR-E7U2037	C	50
	CIMR-E7U2045	D	60
	CIMR-E7U2055	E	75
	CIMR-E7U2075	F	75/100
	CIMR-E7U2090	10	125
	CIMR-E7U2110	11	150
480VAC	CIMR-E7U40P4	20	0.5/0.75
	CIMR-E7U40P7	21	1
	CIMR-E7U41P5	22	1.5/2
	CIMR-E7U42P2	23	3
	CIMR-E7U43P7	24	5
	CIMR-E7U45P5	26	7.5
	CIMR-E7U47P5	27	10
	CIMR-E7U4009	28	15
	CIMR-E7U4011	28	20
	CIMR-E7U4015	29	25
	CIMR-E7U4018	2A	30
	CIMR-E7U4024	2C	40
	CIMR-E7U4030	2C	50
	CIMR-E7U4037	2D	60
	CIMR-E7U4045	2E	75
	CIMR-E7U4055	2F	100
	CIMR-E7U4075	30	125
	CIMR-E7U4090	31	150
	CIMR-E7U4110	32	200
	CIMR-E7U4160	34	250
CIMR-E7U4185	35	300/350	
CIMR-E7U4220	36	400/450	
CIMR-E7U4300	37	500+	

## ◆ Parameters Affected by o2-04

The factory setting of the following parameters may change when the Drive capacity is changed.

Table B.2 Parameters Affected by o2-04	
Parameter Number	Parameter Name <b>Digital Operator Display</b>
b8-04	Energy Saving Coefficient Value <b>Energy Save COEF</b>
C6-02	Carrier Frequency Selection <b>CarrierFreq Sel</b>
E2-01	Motor Rated Current <b>Motor Rated FLA</b>
E2-03	Motor No Load Current <b>No-Load Current</b>
E2-05	Motor Line-to-Line Resistance <b>Term Resistance</b>
L2-02	Momentary Power Loss Ride-thru Time <b>PwrL Ridethru t</b>
L2-03	Momentary Power Loss Minimum Base Block Time <b>PwrL Baseblock t</b>
L2-04	Momentary Power Loss Voltage Recovery Ramp Time <b>PwrL V/F Ramp t</b>
L8-02	Overheat Pre-Alarm Level <b>OH Pre-Alarm Lvl</b>
L8-06	Input Phase Loss Detection Level <b>Ph Loss In Lvl</b>
o2-04	Drive/kVA Selection <b>Inverter Model #</b>

## ◆ Capacity Related Parameter Values

The following tables detail the factory default settings for the parameters that are affected by the setting of parameter o2-04.

Drive Model CIMR-_____	Nominal Hp	Factory Default for b8-04	Factory Default for C6-02	Factory Default for E2-01	Factory Default for E2-03	Factory Default for E2-05	Factory Default for L2-02	Factory Default for L2-03	Factory Default for L2-04	Factory Default for L8-02	Factory Default for L8-06
20P4	0.5/0.75	288.2	10kHz	1.9	1.2	9.842	0.1	0.1	0.3	95°C	5
20P7	2	223.7	10kHz	3.3	1.8	5.156	0.1	0.2	0.3	95°C	7.5
21P5	1.5/2	169.4	10kHz	6.2	2.8	1.997	0.2	0.3	0.3	95°C	10
22P2	3	156.8	8kHz	8.5	3.0	1.601	0.3	0.4	0.3	100°C	12
23P7	5	122.9	10kHz	14.0	4.5	0.771	0.5	0.5	0.3	95°C	12
25P5	7.5	94.75	15kHz	19.6	5.1	0.399	1.0	0.6	0.3	95°C	10
27P5	10	72.69	15kHz	26.6	8.0	0.288	1.0	0.7	0.3	95°C	17
2011	15	70.44	8kHz	39.7	11.2	0.230	1.0	0.8	0.3	95°C	21
2015	20	63.13	10kHz	53.0	15.2	0.138	2.0	0.9	0.3	90°C	17
2018	25	57.87	10kHz	65.8	15.7	0.101	2.0	1.0	0.6	100°C	15
2022	30	51.79	10kHz	77.2	18.5	0.079	2.0	1.0	0.6	90°C	24
2030	40	46.27	10kHz	105.0	21.9	0.064	2.0	1.1	0.6	90°C	20
2037	50	38.16	5kHz	131.0	38.2	0.039	2.0	1.1	0.6	95°C	18
2045	60	35.78	5kHz	160.0	44.0	0.030	2.0	1.2	0.6	100°C	20
2055	75	31.35	8kHz	190.0	45.6	0.022	2.0	1.2	0.1	105°C	17
2075	75/100	23.10	2kHz	260.0	72.0	0.023	2.0	1.3	0.1	110°C	16
2090	125	20.65	2kHz	260.0	72.0	0.023	2.0	1.5	0.1	100°C	18
2110	150	18.12	2kHz	260.0	72.0	0.023	2.0	1.7	0.1	95°C	20

Note: b8-04 = Energy Savings Coefficient  
 C6-02 = Carrier Frequency  
 E2-01 = Motor Rated Current  
 E2-03 = Motor No-Load Current  
 E2-05 = Motor Line-to-Line Resistance  
 L2-02 = Momentary Power Loss Ride-Thru Time  
 L2-03 = Momentary Power Loss Minimum Base Block Time  
 L2-04 = Momentary Power Loss Voltage Recovery Ramp Time  
 L8-02 = Overheat Pre-Alarm Level  
 L8-06 = Input Phase Loss Detection Level

Table B.4 480VAC Drives

Drive Model CIMR-_-_-	Nominal Hp	Factory Default for b8-04	Factory Default for C6-02	Factory Default for E2-01	Factory Default for E2-03	Factory Default for E2-05	Factory Default for L2-02	Factory Default for L2-03	Factory Default for L2-04	Factory Default for L8-02	Factory Default for L8-06
40P4	0.5/0.75	576.40	15kHz	1.0	0.6	38.198	0.1	0.1	0.3	95°C	5
40P7	1	447.40	15kHz	1.6	0.8	22.459	0.1	0.2	0.3	95°C	7.5
41P5	1.5/2	338.80	15kHz	3.1	1.4	10.100	0.2	0.3	0.3	95°C	10
42P2	3	313.60	15kHz	4.2	1.5	6.495	0.3	0.4	0.3	90°C	10
43P7	5	245.80	15kHz	7.0	2.3	3.333	0.5	0.5	0.3	95°C	12
45P5	7.5	189.50	15kHz	13.3	2.6	1.595	1.0	0.6	0.3	95°C	10
47P5	10	145.38	15kHz	19.9	4.0	1.152	1.0	0.7	0.3	90°C	20
4009	15	140.88	8kHz	26.5	5.6	0.922	2.0	0.8	0.3	95°C	23
4011	20	140.88	8kHz	26.5	5.6	0.922	2.0	0.8	0.3	95°C	23
4015	25	126.26	10kHz	32.9	7.6	0.550	2.0	0.9	0.3	95°C	17
4018	30	115.74	10kHz	52.3	7.8	0.403	2.0	1.0	0.6	98°C	17
4024	40	92.54	8kHz	65.6	10.9	0.269	2.0	1.1	0.6	85°C	20
4030	50	92.54	8kHz	65.6	10.9	0.269	2.0	1.1	0.6	85°C	20
4037	60	76.32	8kHz	79.7	19.1	0.155	2.0	1.1	0.6	85°C	20
4045	75	71.56	8kHz	95.0	22.0	0.122	2.0	1.2	0.6	90°C	20
4055	100	67.20	5kHz	130.0	24.0	0.088	2.0	1.2	1.0	90°C	20
4075	125	46.20	5kHz	130.0	36.0	0.092	2.0	1.3	1.0	98°C	16
4090	150	38.91	8kHz	156.0	40.0	0.056	2.0	1.5	1.0	108°C	16
4110	200	36.23	5kHz	190.0	49.0	0.046	2.0	1.7	1.0	100°C	16
4160	250	30.13	5kHz	270.0	70.0	0.029	2.0	1.8	1.0	108°C	14
4185	300/350	30.57	2kHz	310.0	81.0	0.025	2.0	0.7	1.0	95°C	15
4220	400/450	27.13	2kHz	370.0	96.0	0.020	2.0	0.8	1.0	100°C	15
4300	500+	21.76	2kHz	500.0	130.0	0.014	2.1	0.9	1.0	95°C	15

Note: b8-04 = Energy Savings Coefficient  
 C6-02 = Carrier Frequency  
 E2-01 = Motor Rated Current  
 E2-03 = Motor No-Load Current  
 E2-05 = Motor Line-to-Line Resistance  
 L2-02 = Momentary Power Loss Ride-Thru Time  
 L2-03 = Momentary Power Loss Minimum Base Block Time  
 L2-04 = Momentary Power Loss Voltage Recovery Ramp Time  
 L8-02 = Overheat Pre-Alarm Level  
 L8-06 = Input Phase Loss Detection Level

Notes:

# Appendix C Specifications

---

*This appendix details the standard Drive Specifications.*

Standard Drive Specifications ..... C-2

# Standard Drive Specifications

The standard Drive specifications are listed in the following tables.

## ◆ 208-240VAC

Table C.1 208-240VAC Drive Specifications														
Model Number CIMR-E7U		20P4	20P7	21P5	22P2	23P7	25P5	27P5	2011	2015	2018	2022	2030	
Output ratings	Rated output capacity (kVA)		1.4	1.8	3.0	4.1	6.4	8.8	12.0	18.0	23.0	29.0	34.0	44.0
	Motor HP	208V	0.5/0.75	1	1.5/2	3	5	7.5	10	15	20	25	30	40
		230V	0.5/0.75	1	1.5/2	3	5	7.5	10	15	20	25	30	40
	Rated output current (A)		3.6	4.6	7.8	10.8	16.8	23.0	31.0	46.2	59.4	74.8	88.0	115.0
	Max. output voltage (V)		3-phase; 200, 208, 220, 230, or 240VAC (Proportional to input voltage)											
Max. output frequency (Hz)		120 Hz												
Power supply characteristics	Rated voltage (V)		3-phase, 200/208/220/230/240VAC, 50/60 Hz											
	Rated frequency (Hz)		3-phase, 200/208/220/230/240VAC, 50/60 Hz											
	Rated input current (A)		4.3	5.5	9.4	13	20	24	37	53	70	89	98	120
	Allowable voltage fluctuation		+ 10%, - 15%											
Allowable frequency fluctuation		±5%												
Control characteristics	Measures for power supply harmonics	DC Reactor	Optional										Built-in	
		12-Pulse Rectification	Not possible										Possible	
<p>Note: The maximum applicable motor output is given for a standard 4-pole motor. When selecting the actual motor and Drive, be sure that the Drive's rated output current is applicable for the motor's rated current.</p> <p>A phase-shifting transformer is required on the power supply for 12-pulse rectification.</p>														

Table C.1 208-230VAC Drive Specifications (Continued)								
Model Number CIMR-E7U		2037	2045	2055	2075	2090	2110	
Output ratings	Rated output capacity (kVA)		62.0	73.0	82	120.0	140.0	160.0
	Motor HP	208V	50	60	75	100	125	150
		230V	50/60	75	-	100/125	-	150
	Rated output current (A)		162.0	192.0	215	312.0	360.0	415.0
	Max. output voltage (V)		3-phase; 200, 208, 220, 230, or 240VAC (Proportional to input voltage)					
Max. output frequency (Hz)		120 Hz						
Power supply characteristics	Rated voltage (V)		3-phase, 200/208/220/230/240VAC, 50/60 Hz					
	Rated frequency (Hz)		3-phase, 200/208/220/230/240VAC, 50/60 Hz					
	Rated input current (A)		180	212	237	350	396	457
	Allowable voltage fluctuation		+ 10%, - 15%					
Allowable frequency fluctuation		±5%						
Control characteristics	Measures for power supply harmonics	DC Reactor	Built-in					
		12-Pulse Rectification	Possible					
<p>Note: The maximum applicable motor output is given for a standard 4-pole motor. When selecting the actual motor and Drive, be sure that the Drive's rated output current is applicable for the motor's rated current.</p> <p>A phase-shifting transformer is required on the power supply for 12-pulse rectification.</p>								

## ◆ 480VAC

Table C.2 480VAC Drive Specifications

Model Number CIMR-E7U		40P4	40P7	41P5	42P2	43P7	45P5	47P5	4009	4011	4015	4018
Output ratings	Rated output capacity (kVA)	1.4	1.6	2.8	4.0	5.8	9.5	13.0	17.0	21.0	26.0	30.0
	Motor HP (460V)	0.5/0.75	1	1.5/2	3	5	7.5	10	15	20	25	30
	Rated output current (A)	1.8	2.1	3.7	5.3	7.6	12.5	17.0	21.0	27.0	34.0	40.0
	Max. output voltage (V)	3-phase; 380, 400, 415, 440, 460, or 480VAC (Proportional to input voltage.)										
	Max. output frequency (Hz)	120 Hz										
Power supply characteristics	Rated voltage (V) Rated frequency (Hz)	3-phase, 380, 400, 415, 440, 460 or 480VAC, 50/60 Hz										
	Rated input current (A)	2.2	2.5	4.4	6.4	9.0	15	20	26	33	40	48
	Allowable voltage fluctuation	+ 10%, - 15%										
	Allowable frequency fluctuation	±5%										
Control characteristics	Measures for power supply harmonics	DC Reactor	Optional									
		12-pulse Rectification	Not possible									

Table C.2 480VAC Drive Specifications (Continued)

Model Number CIMR-E7U		4024	4030	4037	4045	4055	4075	4090	4110	4160	4185	4220	4300
Output ratings	Rated output capacity (kVA)	41.0	51.0	59.0	73.0	95.0	120.0	140.0	180.0	230.0	315.0	390.0	510.0
	Motor HP (460V)	40	50	60	75	100	125	150	200	250	300/350	400/450	500+
	Rated output current (A)	52.0	67.2	77.0	96.0	125.0	156.0	180.0	240.0	304.0	414.0	515.0	675.0
	Max. output voltage (V)	3-phase, 380, 400, 415, 440, 460 or 480VAC (Proportional to input voltage)											
	Max. output frequency (Hz)	120 Hz											
Power supply characteristics	Max. voltage (V) Rated frequency (Hz)	3-phase, 380, 400, 415, 440, 460, or 480VAC, 50/60 Hz											
	Rated input current (A)	57	74	85	106	134	172	198	264	334	456	567	743
	Allowable voltage fluctuation	+ 10%, - 15%											
	Allowable frequency fluctuation	±5%											
Control characteristics	Measures for power supply harmonics	DC Reactor	Built-in										
		12-Pulse Rectification	Possible										

Note: The maximum applicable motor output is given for a standard 4-pole motor. When selecting the actual motor and Drive, be sure that the Drive's rated output current is applicable for the motor's rated current.  
A 3-wire phase-shifting transformer is required on the power supply for 12-pulse rectification.

Table C.3 Common E7 Drive Specifications

Model Number CIMR-E7U		Specification
Control Characteristics	Control method	Sine wave PWM V/f control
	Speed range	40:1
	Speed control accuracy	±2 to 3% (77°F ± 50°F) (25°C ± 10°C)
	Frequency accuracy (temperature characteristics)	Digital references: ± 0.01% (14°F to 104°F) (-10°C to +40°C)
		Analog references: ±0.1% (77°F ± 50°F) (25°C ±10°C)
	Frequency setting resolution	Digital references: 0.01 Hz
		Analog references: 0.025/50 Hz (10 bit with sign)
	Frequency setting signal (Speed Command)	0-10 Vdc, 4-20 mA
	Acceleration/Deceleration time	0.0 to 6000.0 s (2 selectable combinations of independent acceleration and deceleration settings)
Main control functions	Restarting for momentary power loss, bi-directional speed search, overtorque detection, 5 preset speeds, acceleration/deceleration time changes, S-curve acceleration, 3-wire sequence, auto-tuning, cooling fan ON/OFF control, torque compensation, jump frequencies, upper and lower limits for frequency references, DC braking for starting and stopping, high-slip braking, PI control (with sleep function), energy-saving control, Modbus communications (RS-485/422, 19.2 kbps maximum), fault reset, and copy function	
Protective Functions	Motor protection	Protection by electronic thermal overload relay
	Fuse blown protection	Stops for fuse blown
	Overload capacity and maximum current	110% of rated output current for 60 seconds
	Overvoltage protection	208-240Vac: Stops when main-circuit DC voltage is above 410 V
		480Vac: Stops when main-circuit DC voltage is above 820 V
	Undervoltage protection	208-240Vac: Stops when main-circuit DC voltage is below 190 V
		480Vac: Stops when main-circuit DC voltage is below 380 V
	Momentary power loss ridethru	Power Interruptions of 15 ms or more By selecting the momentary power loss method, operation can be continued if power is restored within 2 s
	Cooling fin overheating	Protection by thermistor
	Stall prevention	Stall prevention during acceleration, deceleration, or running
Grounding protection	Protection by electronic circuits. (50% of inverter rated current)	
Charge indicator	Lit when the main circuit DC voltage is approx. 50 Vdc or more	
Enclosure Type		Enclosed wall-mounted type (NEMA 1): CIMR-E7U20P4 thru 2030 and 40P4 thru 4055 Open chassis type (IP00): CIMR-E7U2022 thru 2110 and 4030 thru 4300
Environment	Ambient operating temperature	14°F to 104°F (-10°C to 40°C) NEMA 1 type 14°F to 113°F (-10°C to 45°C) Open chassis type
	Ambient operating humidity	95% max. (with no condensation)
	Storage temperature	-4°F to 140°F (- 20°C to + 60°C) short-term temperature during transportation
	Application site	Indoor (no corrosive gas, dust, etc.)
	Altitude	3300 ft. (1000 m), higher altitudes by derate
	Vibration	10 to 20 Hz, 32 ft/sec <sup>2</sup> (9.8 m/s <sup>2</sup> ) max.; 20 to 50 Hz, 6.5 ft/sec <sup>2</sup> (2 m/s <sup>2</sup> ) max.
Approval Agencies		UL File E143427

# Appendix D Communication

---

*This appendix details the specifications, connections, and programming of the Drive for Modbus communications. This Drive also contains embedded APOGEE™ FLN and Metasys® communication protocols. For details regarding APOGEE™ FLN, please refer to the E7 APOGEE™ FLN Technical Manual (TM.E7.21). For details regarding Metasys®, please refer to the Technical Manual (TM.E7.22). These two documents can be found on the CD-ROM included with this Drive or at [www.drives.com](http://www.drives.com).*

Using Modbus Communication .....	D-2
Modbus Function Code Details.....	D-7
Modbus Data Tables.....	D-9
Modbus Self-Diagnosis.....	D-14

# Using Modbus Communication

Serial communication can be performed with Direct Digital Controllers (DDCs) or similar devices using the Modbus protocol.

## ◆ Modbus Communication Configuration

Modbus communication is configured using 1 master (PLC) and a maximum of 31 slaves. Serial communication between master and slave is normally initiated by the master and responded to by the slaves.

The master performs serial communication with one slave at a time. Consequently, the slave address of each slave must be initially set, so that the master can perform serial communication using that address. Slaves receiving commands from the master perform the specified functions, and send a response back to the master.

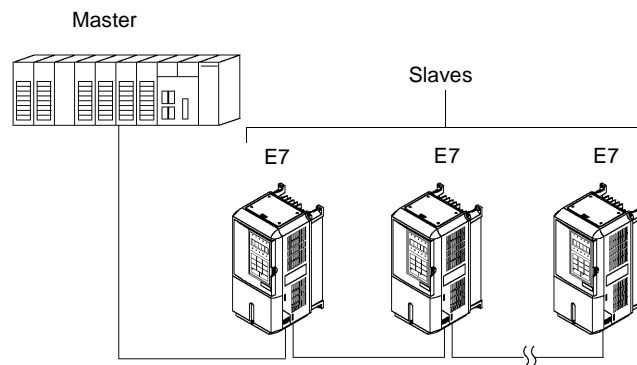

Fig D. 1 Example of Connections between Master and Drive

## ◆ Communication Specifications

The Modbus communication specifications are shown below:

Item	Specifications
Interface	RS-422, RS-485
Communications Cycle	Asynchronous (Start-stop synchronization)
Communications Parameters	Baud rate: Select from 1200, 2400, 4800, 9600, and 19200 bps. Data length: 8 bits fixed Parity: Select from even, odd, or none. Stop bits: 1 bit selected
Communications Protocol	Modbus
Number of Connectable Units	31 units max.

## ◆ Communication Connection Terminal

Modbus communication uses the following terminals: S+, S-, R+, and R-. The terminating resistance must be turned ON only if the Drive is at the very end of the Serial Communication chain. Set the terminating resistance by turning ON pin 1 of switch S1.

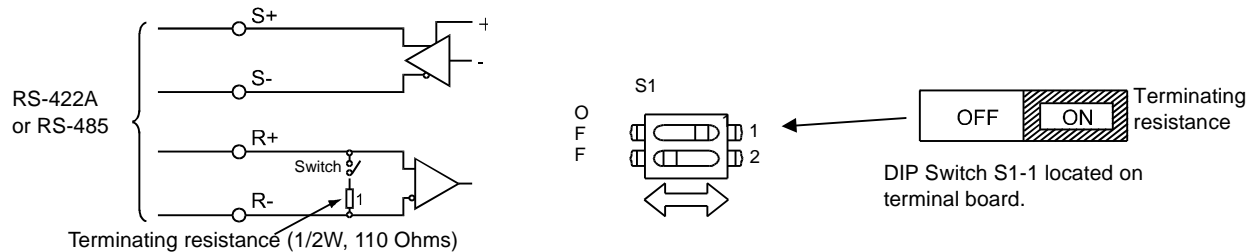

Fig. D.2 Communication Connection Terminals and Terminating Resistance

### IMPORTANT

1. Separate the communication cables from the main circuit cables and control circuit wiring.
2. Use shielded cables for the communication cable, and use proper shield clamps.
3. When using RS-485 communication, connect S+ to R+, and S- to R-, on the control circuit terminal board. See Fig. D-3 below.
4. Shield at one end only.

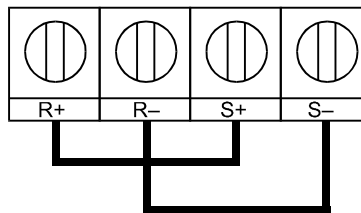

Fig. D.3 RS-485 Communication Connection

## ◆ Procedure for Setting Up Communication

Use the following procedure to perform communication with the DDC.

1. Turn OFF the input to the Drive power and connect the communication cable between the PLC and the Drive.
2. Turn ON the input power to the Drive.
3. Set the required communication parameters (H5-01 to H5-09) using the Digital Operator.
4. Turn OFF the input to the Drive power, and check that the Digital Operator display has completely disappeared.
5. Turn ON the input power to the Drive once again.
6. Perform communication with the DDC.

## ■ Related Parameters

Table D.2 Serial Communication Related Parameters						
Parameter No.	Parameter Name Digital Operator Display	Description	Setting Range	Factory Setting	Chapter Ref #	Menu Location
b1-01	Frequency Reference Selection <b>Reference Source</b>	Selects the speed command (frequency reference) input source. 0: Operator - Digital preset speed d1-01 1: Terminals - Analog Input Terminal A1 (or Terminal A2 see parameter H3-13) 2: Serial Com - RS-485 terminals R+, R-, S+ and S- 3: Option PCB - Option board connected at 2CN	0 to 3	1		Quick Setting
b1-02	Run Command Selection <b>Run Source</b>	Selects the run command input source. 0: Operator - "Hand" and "Off" keys on digital operator 1: Terminal - Contact Closure on Terminal S1 2: Serial Com - RS-485 terminals R+, R-, S+ and S- 3: Option PCB - Option board connected at 2CN	0 to 3	1		Quick Setting
H5-01	Drive Node Address <b>Serial Comm Adr</b>	Selects drive station node number (address) for terminals R+, R-, S+, S-.* Set H5-01 to 0 to disable Drive responses to Modbus communications.	0 to 20 (Modbus) 0 to FF (N2) 0 to 63 (P1)	1F#		Programming
H5-02	Communication Speed Selection <b>Serial Baud Rate</b>	Selects the baud rate for terminals R+, R-, S+ and S-.* 0: 1200 Baud 1: 2400 Baud 2: 4800 Baud 3: 9600 Baud 4: 19200 Baud	0 to 4	3		Programming
H5-03	Communication Parity Selection <b>Serial Com Sel</b>	Selects the communication parity for terminals R+, R-, S+ and S-.* 0: No Parity 1: Even Parity 2: Odd Parity	0 to 2	0		Programming
H5-04	Stopping Method after Communication Error <b>Serial Fault Sel</b>	Selects the stopping method when a communication error is detected. 0: Ramp to Stop 1: Coast to Stop 2: Fast-Stop 3: Alarm Only 4: Run at D1-04 - available when H5-08 = "1:N2 METASYS" OR "2:FLN APOGEE"	0 to 3	3		Programming
H5-05	Communication Error Detection Selection <b>Serial Flt Dtct</b>	Enables or disables the communications timeout detection function. 0: Disabled - A communications loss will NOT cause a communications fault. 1: Enabled - If communications is lost for more than the time specified in parameter H5-09, a communications fault will occur.	0 or 1	1		Programming
H5-06	Drive Transmit Wait Time <b>Transmit WaitTIM</b>	Sets the time from when the drive receives data to when the drive sends data.	5 to 65	5ms		Programming
H5-07	RTS Control Selection <b>RTS Control Sel</b>	Enables or disables request to send (RTS) control: 0: Disabled 1: Enabled	0 or 1	1		Programming
H5-08	Communication Protocol Selection <b>Protocol Select</b>	Selects the communication protocol. 0: Modbus 1: N2 (Metasys) 2: FLN (APOGEE)	0 to 2	0		Programming
H5-09	Communication Error Detection Time <b>CE Detect Time</b>	Determines how long communications must be lost before a fault is annunciated. Works in conjunction with parameters H5-05 and H5-04.	0.0 to 10.0	2.0sec		Programming

\* After these parameters are changed drive power must be cycled before the changes will take effect.

# Hex, see page A-30

Modbus communication can perform the following operations regardless of the settings in b1-01 and b1-02:

1. Monitoring operation status of the Drive
2. Setting and reading Drive parameters
3. Resetting faults
4. Input multi-function commands

### IMPORTANT

An OR operation is performed between the multi-function command input from the DDC and the command input from multi-function digital input terminals S3 to S7.

## ■ Message Format

In Modbus communication, the master sends commands to the slave, and the slave responds. The message format is configured for both sending and receiving as shown below. The length of the data packets is changed by the command (function) contents.

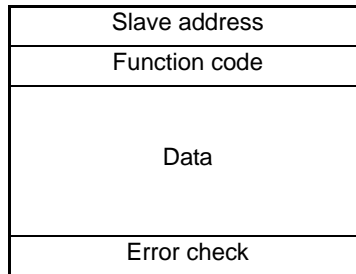

Fig. D.4 Message Format

The space between messages must support the following:

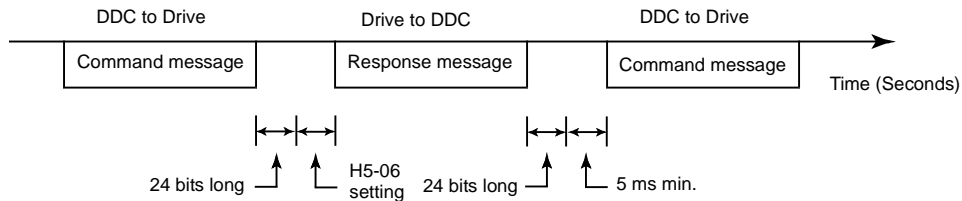

Fig. D.5 Message Spacing

## Slave Address

Set the Drive address from 0 to 32. If 0 is selected, commands from the master will be broadcast (i.e., the Drive will not return responses).

## Function Code

The function code specifies commands. There are four function codes, as shown below.

Function Code (Hexadecimal)	Function	Command Message		Response Message	
		Min. (Bytes)	Max. (Bytes)	Min.* (Bytes)	Max. (Bytes)
03H	Reading/Holding Register Contents	8	8	7	37
06H	Write In Single Holding Register	8	8	8	8
08H	Loopback Test	8	8	8	8
10H	Write In Several Holding Registers	11	41	8	8

\* Minimum bytes for a normal Response Message (error response message is always 5 bytes).

## Data

Configure consecutive data by combining the storage register address (test code for a loopback address) and the data the register contains. The data length changes depending on the command details.

## **Error Check**

Errors are detected during communication using CRC-16. Perform calculations using the following method:

1. The factory setting for CRC-16 communication is typically zero, but when using the Modbus system, set the factory setting to one (e.g., set all 16 bits to 1).
2. Calculate CRC-16 using MSB as slave address LSB, and LSB as the MSB of the final data.
3. Calculate CRC-16 for response messages from the slaves and compare them to the CRC-16 in the response messages.

# Modbus Function Code Details

## ◆ Reading/Holding Register Contents (03H)

Read the contents of the storage register only for specified quantities. The addresses must be consecutive, starting from a specified address. The data content of the storage register are separated into higher 8 bits and lower 8 bits.

The following table shows message examples when reading status signals, error details, data link status, and frequency references from the slave 2 Drive.

Command Message			Response Message (During Normal Operation)			Response Message (During Error)		
Slave Address		02H	Slave Address		02H	Slave Address		02H
Function Code		03H	Function Code		03H	Function Code		83H
Start Address	Higher	00H	Data quantity		08H	Error code		03H
	Lower	20H	1st storage register	Higher	00H	CRC-16	Higher	F1H
Quantity	Higher	00H		Lower	65H		Lower	31H
	Lower	04H	Next storage register	Higher	00H			
CRC-16	Higher	45H		Lower	00H			
	Lower	F0H	Next storage register	Higher	00H			
				Lower	00H			
			Next storage register	Higher	01H			
				Lower	F4H			
			CRC-16	Higher	AFH			
				Lower	82H			

Fig. D.6 Function Code 03H Message Example

## ◆ Write In Single Holding Register (06H)

Command Message			Response Message (During Normal Operation)			Response Message (During Error)		
Slave address		01H	Slave address		01H	Slave address		01H
Function code		06H	Function code		06H	80H + Function Code		86H
Register Address	Upper	00H	Register Address	Upper	00H	Error code		21H
	Lower	01H		Lower	01H	CRC-16	Upper	82H
Setting Data	Upper	00H	Setting Data	Upper	00H		Lower	78H
	Lower	03H		Lower	03H			
CRC-16	Upper	98H	CRC-16	Upper	98H			
	Lower	0BH		Lower	0BH			

Fig. D.7 Function Code 06H Message Example

## ◆ Loopback Test (08H)

The loopback test returns the command message directly as the response message without changing the contents to check the communications between the master and slave. Set user-defined test code and data values.

The following table shows a message example when performing a loopback test with the slave 1 Drive.

Command Message			Response Message (During Normal Operation)			Response Message (During Error)		
Slave address		01H	Slave address		01H	Slave address		01H
Function code		08H	Function code		08H	Function code		89H
Test Code	Higher	00H	Test Code	Higher	00H	Error Code		01H
	Lower	00H		Data	Lower	00H	CRC-16	Higher
Data	Higher	A5H	Data		Higher	A5H		CRC-16
	Lower	37H		CRC-16	Lower	37H		
CRC-16	Higher	DAH	CRC-16		Higher	DAH		
	Lower	8DH		CRC-16	Lower	8DH		

Fig. D.8 Function Code 08H Message Example

## ◆ Write In Several Holding Registers (10H)

Write the specified data to the registers from the specified addresses. The written data must be consecutive, starting from the specified address in the command message: Higher 8 bits, then lower 8 bits, in storage register address order.

The following table shows an example of a message when a forward run command has been set at a speed command of 60.0 Hz in the slave 1 Drive by the PLC.

Command Message			Response Message (During Normal Operation)			Response Message (During Error)		
Slave Address		01H	Slave Address		01H	Slave Address		01H
Function Code		10H	Function Code		10H	Function Code		90H
Start Address	Higher	00H	Start Address	Higher	00H	Error code		02H
	Lower	01H		Quantity	Lower	01H	CRC-16	Higher
Quantity	Higher	00H	Quantity		Higher	00H		CRC-16
	Lower	02H		CRC-16	Lower	02H		
No. of data		04H	CRC-16		Higher	10H		
Lead data	Higher	00H		CRC-16	Lower	08H		
	Lower	01H						
Next data	Higher	02H						
	Lower	58H						
CRC-16	Higher	63H						
	Lower	39H						

\* No. of data = 2 x (quantity)

Fig. D.9 Function Code 10H Message Example

### IMPORTANT

Set the number of data specified using command messages as quantity of specified messages x 2. Handle response messages in the same way.

# Modbus Data Tables

The data tables are shown below. The types of data are as follows: Reference data, monitor data and broadcast data.

## ◆ Reference Data

The reference data table is shown below. Reference data can be read and written to.

Table D.4 Reference Data		
Register No.	Contents	
0000H	Reserved	
0001H	Frequency reference	
	Bit 0	Run Forward 1: Run Forward
	Bit 1	Run Reverse 1: Run Reverse
	Bit 2	External fault 1: Fault (EFO)
	Bit 3	Fault reset 1: Reset command
	Bit 4	ComNet
	Bit 5	ComCtrl
	Bit 6	Multi-function digital input command 3
	Bit 7	Multi-function digital input command 4
	Bit 8	Multi-function digital input command 5
	Bit 9	Multi-function digital input command 6
	Bit A	Multi-function digital input command 7
Bits B to F	Not used	
0002H	Frequency reference (Set units using parameter o1-03)	
0003H to 0005H	Not used	
0006H	PI Setpoint	
0007H	Analog output 1 setting (-11 V = 726 to 11 V = 726) → 10V = 660	
0008H	Analog output 2 setting (-11 V = 726 to 11 V = 726) → 10V = 660	
0009H	Multi-function contact output setting	
	Bit 0	Digital output 1 (Terminal M1-M2) 1: ON 0: OFF
	Bit 1	Digital output 2 (Terminal M3-M4) 1: ON 0: OFF
	Bit 2	Not Used
	Bits 3 to 5	Not used
	Bit 6	Set fault contact (terminal MA-MC) output using bit 7. 1: ON 0: OFF
	Bit 7	Fault contact (terminal MA-MC) 1: ON 0: OFF
Bits 8 to F	Not used	
000AH to 000EH	Not used	
000FH	Reference selection settings	
	Bit 0	Not used
	Bit 1	Input PI setpoint 1: Enabled 0: Disabled
	Bits 3 to B	Not used
	C	Broadcast data terminal S5 input 1: Enabled 0: Disabled
	D	Broadcast data terminal S6 input 1: Enabled 0: Disabled
	E	Broadcast data terminal S7 input 1: Enabled 0: Disabled
F	Not used	

Note: Write 0 to all unused bits. Also, do not write data to reserved registers.

## Monitor Data

The following table shows the monitor data. Monitor data can only be read.

Table D.5 Monitor Data		
Register No.	Contents	
0020H	Drive status	
	Bit 0	Operation 1: Operating 0: Stopped
	Bit 1	Reverse operation 1: Reverse operation 0: Forward operation
	Bit 2	Drive startup complete 1: Completed 0: Not completed
	Bit 3	Fault 1: Fault
	Bit 4	Data setting error 1: Error
	Bit 5	Multi-function digital output 1 (terminal M1 - M2) 1: ON 0: OFF
	Bit 6	Multi-function digital output 2 (terminal M3 - M4) 1: ON 0: OFF
	Bit 7	Not used
Bits 8 to F	Not used	
0021H	Fault details	
	Bit 0	Overcurrent (OC) Ground fault (GF)
	Bit 1	Main circuit overvoltage (OV)
	Bit 2	Drive overload (OL2)
	Bit 3	Drive overheat (OH1, OH2)
	Bit 4	Not used
	Bit 5	Fuse blown (PUF)
	Bit 6	PI feedback reference lost (FbL)
	Bit 7	External error (EF, EFO)
	Bit 8	Hardware error (CPF)
	Bit 9	Motor overload (OL1) or overtorque 1 (OL3) detected
	Bit A	PG broken wire detected (PGO), Overspeed (OS), Speed deviation (DEV)
	Bit B	Main circuit undervoltage (UV) detected
	Bit C	Main circuit undervoltage (UV1), control power supply error (UV2), inrush prevention circuit error (UV3), power loss
Bit D	Missing output phase (LF)	
Bit E	Modbus communications error (CE)	
Bit F	Operator disconnected (OPR)	
0022H	Data link status	
	Bit 0	Writing data
	Bit 1	Not used
	Bit 2	Not used
	Bit 3	Upper and lower limit errors
	Bit 4	Data integrity error
Bits 5 to F	Not used	
0023H	Frequency reference	U1-01
0024H	Output frequency	U1-02
0025H	Output voltage reference	U1-06
0026H	Output current	U1-03
0027H	Output power	U1-08
0028H	Torque reference	U1-09
0029H	Not used	
002AH	Not used	

Table D.5 Monitor Data

Register No.	Contents	
002BH	Sequence input status	
	Bit 0	Input terminal S1 1: ON 0: OFF
	Bit 1	Input terminal S2 1: ON 0: OFF
	Bit 2	Multi-function digital input terminal S3 1: ON 0: OFF
	Bit 3	Multi-function digital input terminal S4 1: ON 0: OFF
	Bit 4	Multi-function digital input terminal S5 1: ON 0: OFF
	Bit 5	Multi-function digital input terminal S6 1: ON 0: OFF
	Bit 6	Multi-function digital input terminal S7 1: ON 0: OFF
	Bits 7 to F	Not used
002CH	Drive status	
	Bit 0	Operation 1: Operating
	Bit 1	Zero speed 1: Zero speed
	Bit 2	Frequency agree 1: Matched
	Bit 3	Desired frequency agree 1: Matched
	Bit 4	Frequency detection 1 1: Output frequency $\leq$ L4-01
	Bit 5	Frequency detection 2 1: Output frequency $\geq$ L4-01
	Bit 6	Drive startup completed 1: Startup completed
	Bit 7	Low voltage detection 1: Detected
	Bit 8	Baseblock 1: Drive output baseblock
	Bit 9	Frequency reference mode 1: Not communication 0: Communication
	Bit A	Run command mode 1: Not communication 0: Communication
	Bit B	Overtorque detection 1: Detected
	Bit C	Frequency reference lost 1: Lost
	Bit D	Retrying error 1: Retrying
Bit E	Error (including Modbus communications time-out) 1: Error occurred	
Bit F	Modbus communications time-out 1: Timed out	
002DH	Multi-function digital output status	
	Bit 0	Multi-function digital output 1 (terminal M1-M2) 1: ON 0: OFF
	Bit 1	Multi-function digital output 2 (terminal M3-M4): 1: ON 0: OFF
	Bit 2	Not used
	Bits 3 to F	Not used
002EH - 0030H	Not used	
0031H	Main circuit DC voltage	
0032H - 0037H	Not used	
0038H	PI feedback level (Input equivalent to 100%/Max. output frequency; 10/1%; without sign)	
0039H	PI input level ( $\pm 100\%$ / $\pm$ Max. output frequency; 10/1%; with sign)	
003AH	PI output level ( $\pm 100\%$ / $\pm$ Max. output frequency; 10/1%; with sign)	
003BH	CPU software number	
003CH	Flash software number	
003DH	Communication error details	
	Bit 0	CRC error
	Bit 1	Invalid data length
	Bit 2	Not used
	Bit 3	Parity error
	Bit 4	Overrun error
	Bit 5	Framing error
	Bit 6	Time-out
	Bits 7 to F	Not used
003EH	KVA setting	
003FH	Control method	

Note: Communication error details are stored until an error reset is input (errors can be reset while the Drive is operating).

## Broadcast Data

The following table shows the broadcast data. Broadcast data can be written to.

Table D.6 Broadcast Data		
Register Address	Contents	
0001H	Operation signal	
	Bit 0	Run command 1: Operating 0: Stopped
	Bit 1	Reverse operation command 1: Reverse 0: Forward
	Bits 2 and 3	Not used
	Bit 4	External error 1: Fault (set using H1-01)
	Bit 5	Error Fault 1: Reset command (set using H1-02)
	Bits 6 to B	Not used
	Bit C	Multi-function digital input terminal S5 input
	Bit D	Multi-function digital input terminal S6 input
	Bit E	Multi-function digital input terminal S7 input
	Bit F	Not used.
0002H	Frequency reference	30000/100%

Note: Bit signals not defined in the broadcast operation signals use local node data signals continuously.

## Enter Command

When writing parameters to the Drive from the PLC using Modbus communication, the parameters are temporarily stored in the constant data area in the Drive. To enable these parameters in the parameter data area, use the Enter command.

There are two types of Enter commands:

1. Enter commands that enable parameter data in RAM
2. Enter commands that write data to EEPROM (non-volatile memory) in the Drive at the same time as enabling data in RAM.

The following table shows the Enter command data. Enter command data can only be written.

The Enter command is enabled by writing 0 to register number 0900H or 0901H.

Table D.7 Enter Command	
Register No.	Contents
0900H	Write parameter data to EEPROM
0910H	Parameter data is not written to EEPROM, but refreshed in RAM only.

### IMPORTANT

The maximum number of times you can write to EEPROM using the Drive is 100,000. Do not frequently execute Enter commands (0900H) written to EEPROM.

The Enter command registers are write-only. Consequently, if reading these registers, the register address will become invalid (Error code: 02H).

## Error Codes

The following table shows Modbus communication error codes.

Error Code	Contents
01H	Function code error A function code other than 03H, 08H, or 10H has been set by the PLC.
02H	Invalid register number error <ul style="list-style-type: none"> <li>• The register address you are attempting to access is not recorded anywhere.</li> <li>• With broadcast sending, a start address other than 0000H, 0001H, or 0002H has been set.</li> </ul>
03H	Invalid quantity error <ul style="list-style-type: none"> <li>• The number of data packets being read or written is outside the range of 1 to 16.</li> <li>• In write mode, the number of data packets in the message is not No. of packets x 2.</li> </ul>
21H	Data setting error <ul style="list-style-type: none"> <li>• Upper limit or lower limit error has occurred in the control data or when writing parameters.</li> <li>• When writing parameters, the parameter setting is invalid.</li> </ul>
22H	Write mode error <ul style="list-style-type: none"> <li>• Attempting to write parameters to the Drive during run.</li> <li>• Attempting to write via Enter commands during run.</li> <li>• Attempting to write parameters other than A1-00 to A1-05, E1-03, or 02-04 when a CPF03 (defective EEPROM) fault has occurred.</li> <li>• Attempting to write read-only data.</li> </ul>
23H	Writing during main circuit undervoltage (UV) fault <ul style="list-style-type: none"> <li>• Writing parameters to the Drive during UV (main circuit undervoltage) alarm.</li> <li>• Writing via Enter commands during UV (main circuit undervoltage) alarm.</li> </ul>
24H	Writing error during parameters processing Attempting to write parameters while processing parameters in the Drive.

## Slave Not Responding

In the following cases, the slave will ignore the write function.

- When a communication error (overrun, framing, parity, or CRC-16) is detected in the command message.
- When the slave address in the command message and the slave address in the Drive do not agree.
- When the data that configures the message and the data time length exceed 24 bits.
- When the command message data length is invalid.

### IMPORTANT

If the slave address specified in the command message is 0, all slaves execute the write function, but do not return response messages to the master.

# Modbus Self-Diagnosis

The Drive has a built-in function for self-diagnosing the operations of serial communication interface circuits. The self-diagnosis function connects the communication parts of the send and receive terminals, receives the data sent by the Drive, and checks if communication is being performed normally.

Perform the self-diagnosis function using the following procedure.

1. Turn ON the power supply to the Drive, and set parameter H1-05 (Terminal S7 Function Selection) to 67 (Comm Test Mode).
2. Turn OFF the power supply to the Drive.
3. Perform wiring according to the following diagram while the power supply is turned OFF.
4. Turn ON the terminating resistance. (Turn ON pin 1 on DIP switch 1.)
5. Turn ON the power supply to the Drive again.

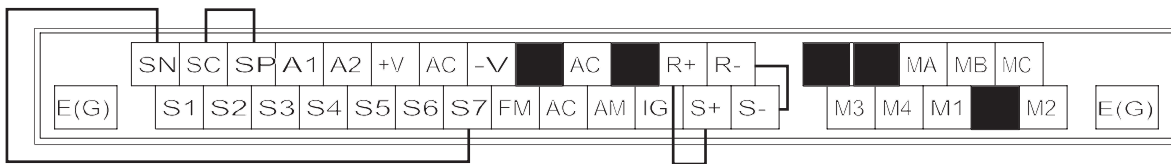

Fig. D.10 Communication Terminal Connection for Self -Diagnosis Function

6. During normal self-diagnostic operation, the Digital Operator displays the frequency reference value. If an error occurs, a CE (Modbus communication error) alarm will be displayed on the Digital Operator, the fault contact output will be turned ON, and the Drive operation ready signal will be turned OFF.

# Appendix E Peripheral Devices

---

*This appendix describes recommended branch short circuit protection and peripheral devices.*

Branch Circuit Short Circuit Protection.....	E-2
Branch Circuit Overload Protection.....	E-5
Peripheral Devices .....	E-6

# Branch Circuit Short Circuit Protection

The following peripheral devices may be required between the AC main circuit power supply and the Drive input terminals L1(R), L2(S), and L3(T). Refer to applicable codes to determine the devices necessary for a given installation. Use Table E.1 or E.2 when selecting fuses and circuit breakers per the NEC. When selecting semiconductor fuses to provide Drive input I<sup>2</sup>t protection and comply with UL, CSA, NEC, and CEC branch circuit short circuit protection requirements, select one of the fuses in Table E.3 or E.4.

**Fuse Type:** UL designated Time-Delay or Non-Time-Delay Fuse  
 Class: CC, J, T, RK1 or RK5  
 Designators (typical):KTK, FNQ, FRS, LPJ, LPS, JKS, JN, or JJS  
 Voltage Rating: 250V for Drives with 208-240V input  
 600V for Drives with 480V input

**Circuit Breaker Type:** Inverse Time (MCCB) or Instantaneous Trip (MCP)  
 Voltage Rating: 600V

Table E.1 Recommended Fuse and Circuit Breaker Ratings per NEC (208-240Vac Input)

Model CIMR-E7U	Hp	Input Amps *1 (Continuous Rating)	Output Amps *1 (Continuous Rating)	Fuse Selection Criteria		Circuit Breaker Selection Criteria
				Maximum Time-Delay Fuse Rating (A)	Maximum Non-Time-Delay Fuse Rating (A)	Maximum CB Rating (A)
20P4	0.5/0.75	4.3	3.6	6	12	15
20P7	1	5.5	4.6	8	12	15
21P5	1.5/2	9.4	7.8	15	15	15
22P2	3	13	10.8	20	20	20
23P7	5	20	16.8	30	30	35
25P5	7.5	24	23	40	50	45
27P5	10	37	31	60	80	80
2011	15	53	46.2	80	80	100
2015	20	70	59.4	110	125	125
2018	25	89	74.8	125	150	150
2022	30	98	88	150	150	175
2030	40	120	115	200	200	225
2037	50	180	162	250	250	300
2045	60	212	192	300	300	350
2055	75	237	215	350	350	450
2075	75/100	350	312	450	450	600
2090	125	396	360	600	600	700
2110	150	457	415	700	700	900

\*1 Input and Output Amps are based on the Normal Duty (ND) current rating. Consult the Specification section for details on the Heavy Duty (HD) and Normal Duty (ND) ratings.

Table E.2 Recommended Fuse and Circuit Breaker Ratings per NEC (480Vac Input)

Model CIMR-E7U	Hp	Input Amps *1 (Continuous Rating)	Output Amps *1 (Continuous Rating)	Fuse Selection Criteria		Circuit Breaker Selection Criteria
				Maximum Time-Delay Fuse Rating (A)	Maximum Non-Time-Delay Fuse Rating (A)	Maximum CB Rating (A)
40P4	0.5/0.75	2.2	1.8	4	10	15
40P7	1	2.5	2.1	4	10	15
41P5	1.5/2	4.4	3.7	8	12	15
42P2	3	6.4	5.3	10	15	15
43P7	5	9	7.6	15	20	20
44P0	-	10.4	8.7	15	30	20
45P5	7.5	15	12.5	25	30	30
47P5	10	20	17	30	30	40
4009	15	33	21	45	50	60
4011	20	33	27	45	50	60
4015	25	40	34	60	70	80
4018	30	48	40	70	80	90
4022	-	55	50.4	80	80	100
4024	40	74	52	100	100	125
4030	50	74	67.2	100	100	125
4037	60	85	77	125	125	150
4045	75	106	96	150	150	200
4055	100	134	125	200	200	225
4075	125	172	156	250	250	300
4090	150	198	180	300	300	400
4110	200	264	240	350	350	450
4132	-	286	260	400	400	600
4160	250	334	304	450	450	700
4185	300/350	456	414	600	600	800
4220	400/450	567	515	700	700	1000
4300	500+	743	675	900	900	1200

\*1 Input and Output Amps are based on the Normal Duty (ND) current rating. Consult the Specification section for details on the Heavy Duty (HD) and Normal Duty (ND) ratings.

Table E.3 Semiconductor Fuses for Drive I<sup>2</sup>t Protection and Branch Circuit Short Circuit Protection (200V Series)

Drive Model No. CIMR-E7*	Recommended			Alternate 1			Alternate 2		
	Fuse Mfr.	Model No.	Rating	Fuse Mfr.	Model No.	Rating	Fuse Mfr.	Model No.	Rating
20P4	Ferraz	A60Q12-2	600V, 12A	Ferraz	A070GRB006T13	700V, 6A	Bussmann	FWH-20A14F	500V, 20A
20P7	Ferraz	A60Q12-2	600V, 12A	Ferraz	A070GRB006T13	700V, 6A	Bussmann	FWH-20A14F	500V, 20A
21P5	Ferraz	A60Q15-2	600V, 15A	Ferraz	A70QS25-22F	700A, 25A	Bussmann	FWH-20A14F	500V, 20A
22P2	Ferraz	A60Q20-2	600V, 20A	Ferraz	6,900CPGRC14.51/25	690V, 25A	Bussmann	FWH-25A14F	500V, 25A
23P7	Ferraz	A60Q30-2	600V, 30A	Ferraz	A70QS32-14F	700A, 32A	Bussmann	FWH-45B	500V, 45A
25P5	Ferraz	A50P50-4	500V, 50A	Ferraz	A70QS50-14F	700V, 50A	Bussmann	FWH-80B	500V, 80A
27P5	Ferraz	A50P80-4	500V, 80A	Ferraz	A50QS70-4	500V, 70A	Bussmann	FWH-80B	500V, 80A
2011	Ferraz	A50P80-4	500V, 80A	Ferraz	A50QS100-4	500V, 100A	Bussmann	FWH-100B	500V, 100A
2015	Ferraz	A50P125-4	500V, 125A	Ferraz	A50QS150-4	500V, 150A	Bussmann	FWH-175B	500V, 175A
2018	Ferraz	A50P150-4	500V, 150A	Ferraz	A50QS175-4	500V, 175A	Bussmann	FWH-200B	500V, 200A
2022	Ferraz	A50P150-4	500V, 150A	Ferraz	A50QS200-4	500V, 200A	Bussmann	FWH-200B	500V, 200A
2030	Ferraz	A50P200-4	500V, 200A	Bussmann	FWH-200B	500V, 200A	Bussmann	FWH-225B	500V, 225A
2037	Ferraz	A50P250-4	500V, 250A	Ferraz	A30QS275-4	300V, 275A	Bussmann	170M4610	690V, 315A
2045	Ferraz	A50P300-4	500V, 300A	Ferraz	A30QS350-4	300V, 350A	Bussmann	FWH-350A	500V, 350A
2055	Ferraz	A50P350-4	500V, 350A	Bussmann	FWH-400A	500V, 400A	Bussmann	FWH-450A	500V, 450A
2075	Ferraz	A50P450-4	500V, 450A	Ferraz	A070URD33KI0550	700V, 550A	Bussmann	FWH-500A	500V, 500A
2090	Ferraz	A50P600-4	500V, 600A	Ferraz	A70P600-4	700V, 600A	Bussmann	FWH-600A	500V, 600A
2110	Ferraz	A50P600-4	500V, 600A	Ferraz	A70P700-4	700V, 700A	Bussmann	FWH-700A	500V, 700A

\* Denotes letter A through Z

Table E.4 Semiconductor Fuses for Drive I<sup>2</sup>t Protection and Branch Circuit Short Circuit Protection (400V Series)

Drive Model No. CIMR-E7*	Recommended			Alternate 1			Alternate 2		
	Fuse Mfr.	Model No.	Rating	Fuse Mfr.	Model No.	Rating	Fuse Mfr.	Model No.	Rating
40P4	Ferraz	A60Q10-2	600V, 10A	Ferraz	A070GRB006T13	700V, 6A	Ferraz	A70QS16-14F	690V, 16A
40P7	Ferraz	A60Q10-2	600V, 10A	Ferraz	A070GRB006T13	700V, 6A	Ferraz	A70QS16-14F	690V, 16A
41P5	Ferraz	A60Q12-2	600V, 12A	Ferraz	6,900CPGRC14.51/25	690V, 25A	Ferraz	A70QS20-14F	690V, 20A
42P2	Ferraz	A60Q15-2	600V, 15A	Ferraz	A70QS25-22F	700V, 25A	Ferraz	A70QS20-14F	690V, 20A
43P7	Ferraz	A60Q20-2	600V, 20A	Ferraz	A70QS20-14F	700V, 20A	Ferraz	A70QS25-14F	690V, 25A
44P0	Ferraz	A60Q30-2	600V, 30A	Ferraz	A70QS32-14F	700V, 32A	Ferraz	A70QS40-14F	690V, 40A
45P5	Ferraz	A60Q30-2	600V, 30A	Ferraz	A70QS32-14F	700V, 32A	Ferraz	A70QS40-14F	690V, 40A
47P5	Ferraz	A60Q30-2	600V, 30A	Ferraz	A70QS40-14F	700V, 40A	-	-	-
4009	Ferraz	A70P50-4	700V, 50A	Ferraz	A50QS50-4	500V, 50A	Bussmann	FWH-80B	500V, 80A
4011	Ferraz	A70P50-4	700V, 50A	Ferraz	A50QS50-4	500V, 50A	Bussmann	FWH-80B	500V, 80A
4015	Ferraz	A70P70-4	700V, 70A	Ferraz	A50QS80-4	500V, 80A	Bussmann	FWH-100B	500V, 100A
4018	Ferraz	A70P80-4	700V, 80A	Ferraz	A50QS100-4	500V, 100A	Bussmann	FWH-125B	500V, 125A
4022	Ferraz	A70P80-4	700V, 80A	Ferraz	A50QS100-4	500V, 100A	Bussmann	FWH-125B	500V, 125A
4024	Ferraz	A70P100-4	700V, 100A	Ferraz	A50QS125-4	500V, 125A	Bussmann	FWH-125B	500V, 125A
4030	Ferraz	A70P100-4	700V, 100A	Ferraz	A50QS125-4	500V, 125A	Bussmann	FWH-125B	500V, 125A
4037	Ferraz	A70P125-4	700V, 125A	Ferraz	A50QS125-4	500V, 125A	Bussmann	FWH-150B	500V, 150A
4045	Ferraz	A70P150-4	700V, 150A	Ferraz	A50QS150-4	500V, 150A	Bussmann	FWH-175B	500V, 175A
4055	Ferraz	A70P200-4	700V, 200A	Ferraz	A70QS200-4	700V, 200A	Bussmann	FWH-200B	500V, 200A
4075	Ferraz	A70P250-4	700V, 250A	Ferraz	A50QS250-4	500V, 250A	Bussmann	FWH-250A	500V, 250A
4090	Ferraz	A70P300-4	700V, 300A	Ferraz	A50QS300-4	500V, 300A	Bussmann	170M4611	690V, 350A
4110	Ferraz	A70P350-4	700V, 350A	Ferraz	A50P350-4	500V, 350A	Bussmann	170M4611	690V, 350A
4132	Ferraz	A70P400-4	700V, 400A	Ferraz	A70P500-4	700V, 500A	Bussmann	170M5610	690V, 500A
4160	Ferraz	A70P450-4	700V, 450A	Ferraz	A70QS700-4	700V, 700A	Bussmann	FWH-600A	500V, 600A
4185	Ferraz	A70P600-4	700V, 600A	Ferraz	A70QS700-4	700V, 700A	Bussmann	FWH-700A	500V, 700A
4220	Ferraz	A70P700-4	700V, 700A	Bussmann	FWH-800A	500V, 800A	Bussmann	FWH-1000A	500V, 1000A
4300	Ferraz	A70P900-4	700V, 900A	Bussmann	FWH-1000A	500V, 1000A	Bussmann	FWH-1200A	500V, 1200A

\* Denotes letter A through Z

## Branch Circuit Overload Protection

All models have built-in UL evaluated motor overload protection. Motor overload protection is also provided in accordance with the NEC and CEC. Additional branch circuit overload protection is not required for single motor applications.

# Peripheral Devices

The following peripheral devices may be required to be mounted between the AC main circuit power supply and the Drive input terminals R/L1, S/L2, and T/L3.

## CAUTION

Never connect a general LC/RC noise filter to the Drive output circuit.  
Never connect a phase-advancing capacitor to the input or output sides, or a surge suppressor to the output side of the Drive. When magnetic contactor is installed between the Drive and the motor, never turn it on or off during operation.

For more details on peripheral devices, contact the manufacturer.

## Magnetic Contactor

Mount a surge protector on the coil. When using a magnetic contactor to start and stop the Drive, do not exceed one start per hour.

## AC and DC reactor

When using models E7U20P4 thru E7U2018 and E7U40P4 thru E7U4018 on a power supply transformer with a capacity of 600kVA or more, install an AC or DC reactor. The reactor improves the input power factor and provides protection to the rectifier circuit within the Drive.

## Noise filter

Use a noise filter exclusively for the Drive if radio noise generated from the Drive causes other control devices to malfunction.

# Appendix F Spare Parts

---

*This appendix lists the primary spare parts that may be needed to maintain or service the Drive.*

E7 Primary Spare Parts - 208/230/240VAC..... F-2  
E7 Primary Spare Parts - 480VAC..... F-3

Note: Part numbers listed in Appendix F are for units being produced at the date of publication.

When purchasing replacement parts, confirm with Yaskawa Customer Service Center (800-927-5297) that part numbers ordered are compatible with the Drive or Bypass unit serial numbers specific to the installation.

# E7 Primary Spare Parts - 208/230/240VAC

Drive Model CIMR-E7U	Nominal Hp	Power PCB (3PCB)	Gate Drive PCB (3PCB)	Control PCB (1PCB)	Terminal PCB (2PCB)	Diode Module
20P4	0.5/0.75	ETP617012	N/A	ETC618021-S3010	ETC618141	INSIDE THE POWER MODULE
20P7	1	ETP617012	N/A	ETC618021-S3010	ETC618141	
21P5	1.5/2	ETP617022	N/A	ETC618021-S3010	ETC618141	
22P2	3	ETP617032	N/A	ETC618021-S3010	ETC618141	
23P7	5	ETP617042	N/A	ETC618021-S3010	ETC618141	
25P5	7.5	ETP617052	N/A	ETC618021-S3010	ETC618141	
27P5	10	ETP617062	N/A	ETC618021-S3010	ETC618141	
2011	15	ETP617422	N/A	ETC618021-S3010	ETC618141	SID003114 (D1)
2015	20	N/A	ETC617032	ETC618021-S3010	ETC618141	SID003113 (D1)
2018	25	N/A	ETC617042	ETC618021-S3010	ETC618141	SID003113 (D1)
2022	30	N/A	ETC617053	ETC618021-S3010	ETC618141	SID003114 (D1,D2)
2030	40	N/A	ETC617063	ETC618021-S3010	ETC618141	SID003113 (D1,D2)
2037	50	N/A	ETC617073	ETC618021-S3010	ETC618141	SID003130 (D1,D2)
2045	60	N/A	ETC617083	ETC618021-S3010	ETC618141	SID003115 (D1,D2)
2055	75	N/A	ETC617093	ETC618021-S3010	ETC618141	SID003115 (D1,D2)
2075	75/100	N/A	ETC617103	ETC618021-S3010	ETC618141	SID003116 (D1,D6)
2090	125	N/A	ETC617113	ETC618021-S3010	ETC618141	SID003116 (D1,D6)
2110	150	N/A	ETC617531	ETC618021-S3010	ETC618141	SID003108 (D1,D12)

Drive Model CIMR-E7U	Nominal Hp	Power Module	Transistor Module	DC Bus Fuse	Heat Sink Fan	Internal Fan
20P4	0.5/0.75	STR001297 (Q1)	INSIDE THE POWER MODULE	FU-002029 (F1)	N/A	N/A
20P7	1	STR001297 (Q1)		FU-002029 (F1)	N/A	N/A
21P5	1.5/2	STR001299 (Q1)		FU-002029 (F1)	N/A	N/A
22P2	3	STR001301 (Q1)		FU-002030 (F1)	N/A	N/A
23P7	5	STR001303 (Q1)		FU-002031 (F1)	FAN001066 (B1)	N/A
25P5	7.5	STR001304 (Q1)		FU-002099 (F1)	FAN001066 (B1)	N/A
27P5	10	STR001278 (Q1)		FU-002107 (F1)	FAN001066 (B1,B2)	N/A
2011	15	N/A	STR001315 (Q1)	FU-002108 (F1)	FAN001066 (B1,B2)	FAN001043 (B3)
2015	20	N/A	STR001315 (Q1)	FU-002108 (F1)	FAN001065 (B1,B2)	N/A
2018	25	N/A	STR001320 (Q1)	FU-002109 (F1)	FAN001065 (B1,B2)	FAN001043 (B3)
2022	30	N/A	STR001314 (Q1)	FU-002110 (F1)	FAN001039 (B1,B2)	N/A
2030	40	N/A	STR001323 (Q1)	FU-002110 (F1)	FAN001039 (B1,B2)	N/A
2037	50	N/A	STR001293 (Q1-Q3)	FU-002102 (F1)	FAN001049 (B1,B2)	FAN001053 (B4)
2045	60	N/A	STR001335 (Q1-Q3)	FU-000925 (F1)	FAN001049 (B1,B2)	FAN001053 (B4)
2055	75	N/A	STR001335 (Q1-Q3)	FU-000938 (F1)	FAN001052 (B1,B2)	FAN001054 (B4)
2075	75/100	N/A	STR001349 (Q1-Q6)	FU-000926 (F1)	FAN001056 (B1,B2)	FAN001054 (B4)
2090	125	N/A	STR001338 (Q1-Q6)	FU-002105 (F1)	FAN001056 (B1,B2)	FAN001054 (B4)
2110	150	N/A	STR001351 (Q1-Q12)	FU-002106 (F1)	FAN001056 (B1,B2)	FAN001054 (B4)

# E7 Primary Spare Parts - 480VAC

Drive Model CIMR-E7U	Nominal Hp	Power PCB (3PCB)	Gate Drive PCB (3PCB)	Control PCB (1PCB)	Diode Module
40P4	0.5/0.75	ETP617082	N/A	ETC618021-S3010	Inside the Power Module
40P7	1	ETP617082	N/A	ETC618021-S3010	Inside the Power Module
41P5	1.5/2	ETP617092	N/A	ETC618021-S3010	Inside the Power Module
42P2	3	ETP617102	N/A	ETC618021-S3010	Inside the Power Module
43P7	5	ETP617112	N/A	ETC618021-S3010	Inside the Power Module
45P5	7.5	ETP617132	N/A	ETC618021-S3010	Inside the Power Module
47P5	10	ETP617142	N/A	ETC618021-S3010	Inside the Power Module
4009	15	ETP617152	N/A	ETC618021-S3010	Inside the Power Module
4011	20	ETP617152	N/A	ETC618021-S3010	Inside the Power Module
4015	25	ETP617162	N/A	ETC618021-S3010	SID003112 (D1)
4018	30	ETP617172	N/A	ETC618021-S3010	SID000605 (D1)
4024	40	N/A	ETC617151	ETC618021-S3010	SID003112 (D1,D2)
4030	50	N/A	ETC617151	ETC618021-S3010	SID003112 (D1,D2)
4037	60	N/A	ETC617161	ETC618021-S3010	SID003112 (D1,D2)
4045	75	N/A	ETC617171	ETC618021-S3010	SID000605 (D1,D2)
4055	100	N/A	ETC617181	ETC618021-S3010	SID000605 (D1,D2)
4075	125	N/A	ETC617190	ETC618021-S3010	SID003117 (D1,D2)
4090	150	N/A	ETC617200	ETC618021-S3010	SID003117 (D1,D2)
4110	200	N/A	ETC617210	ETC618021-S3010	SID003109 (D1,D6)
4160	250	N/A	ETC617230	ETC618021-S3010	SID003119 (D1,D6)
4185	300/350	N/A	ETC617240	ETC618021-S3010	SID003119 (D1,D6)
4220	400/450	N/A	ETC617250	ETC618021-S3010	SID003131 (D1,D6)
4300	500+	N/A	ETC617260	ETC618021-S3010	SID003119(D1,D12)

Drive Model CIMR-E7U	Nominal Hp	Power Module	Transistor Module	DC Bus Fuse	Heat Sink Fan	Internal Fan
40P4	0.5/0.75	STR001298 (Q1)	Inside the Power Module	FU-002029 (F1)	N/A	N/A
40P7	1	STR001298 (Q1)	Inside the Power Module	FU-002029 (F1)	N/A	N/A
41P5	1.5/2	STR001298 (Q1)	Inside the Power Module	FU-002029 (F1)	N/A	N/A
42P2	3	STR001298 (Q1)	Inside the Power Module	FU-002029 (F1)	FAN001066 (B1)	N/A
43P7	5	STR001300 (Q1)	Inside the Power Module	FU-002031 (F1)	FAN001066 (B1)	N/A
45P5	7.5	STR001302 (Q1)	Inside the Power Module	FU-002031 (F1)	FAN001066 (B1)	N/A
47P5	10	STR001279 (Q1)	Inside the Power Module	FU-002032 (F1)	FAN001066 (B1,B2)	N/A
4009	15	N/A	STR001280 (Q1)	FU-002037 (F1)	FAN001066 (B1,B2)	FAN001043 (B3)
4011	20	N/A	STR001280 (Q1)	FU-002037 (F1)	FAN001066 (B1,B2)	FAN001043 (B3)
4015	25	N/A	STR001318 (Q1)	FU-002038 (F1)	FAN001065 (B1,B2)	N/A
4018	30	N/A	STR001318 (Q1)	FU-002038 (F1)	FAN001065 (B1,B2)	FAN001043 (B3)
4024	40	N/A	STR001324 (Q1)	FU-002039 (F1)	FAN001039 (B1,B2)	N/A
4030	50	N/A	STR001324 (Q1)	FU-002039 (F1)	FAN001039 (B1,B2)	N/A
4037	60	N/A	STR001316 (Q1-Q3)	FU-002040 (F1)	FAN001044 (B1,B2)	N/A
4045	75	N/A	STR001317 (Q1-Q3)	FU-002040 (F1)	FAN001044 (B1,B2)	N/A
4055	100	N/A	STR001317 (Q1-Q3)	FU-002101 (F1)	FAN001044 (B1,B2)	N/A
4075	125	N/A	STR001294 (Q1-Q3)	FU-002112 (F1)	FAN001052 (B1,B2)	FAN001054 (B4)
4090	150	N/A	STR001336 (Q1-Q6)	FU-002113 (F1)	FAN001052 (B1,B2)	FAN001054 (B4)
4110	200	N/A	STR001336 (Q1-Q6)	FU-002114 (F1)	FAN001056 (B1,B2)	FAN001054 (B4)
4160	250	N/A	STR001322 (Q1-Q3)	FU-000895 (F1)	FAN001056 (B1,B2)	FAN001054 (B4)
4185	300/350	N/A	STR001339 (Q1-Q12)	FU-000895 (F1)	FAN001056 (B1,B4)	FAN001054 (B6,B7)
4220	400/450	N/A	STR001341 (Q1-Q12)	FU-002116 (F1)	FAN001056 (B1,B4)	FAN001054 (B6,B7)
4300	500+	N/A	STR001342 (Q1-Q12)	FU-002117 (F1)	FAN001082 (B1,B5)	FAN001054 (B6,B7)

Notes:

# Appendix G

## EMC Compatibility

---

EMC Compatibility.....	G-2
Electromagnetic Compatibility (EMC) .....	G-3

# EMC Compatibility

---

## ◆ Introduction

This section describes the measures necessary to comply with the EMC (Electro Magnetic Compatibility) Directive. The manual's installation and wiring instructions must be followed for compliance.

Yaskawa products are tested by authorized organizations using the standards listed below.

Product standard:      EN 61800-3:1996  
                                 EN 61000-3-2; A1, A2, A14:2000

---

## ◆ Measures to Ensure Conformity of Installed Yaskawa Drives to EMC Directive

Yaskawa Drives are not required to be installed in a switch cabinet.

It is not possible to give detailed instructions for all possible types of installations, therefore this manual provides general guidelines.

All electrical equipment produces radio and line-borne interference at various frequencies. The power leads pass this on to the surrounding environment like an antenna. Connecting an item of electrical equipment (e.g. Drive) to a supply without a line filter can allow High Frequency (HF) or Low Frequency (LF) interference to penetrate the power distribution system. The basic countermeasures are isolation of the wiring of control and power components, proper grounding, and shielding of cables.

A large contact area is necessary for low-impedance grounding of HF interference. The use of grounding, straps instead of cables is therefore highly recommended.

Cable shields must be connected with ground clips.

---

## ◆ Cable Installation

Measures Against Line-Borne Interference:

Line filter and Drive must be mounted on the same metal plate. Mount the two components as close to each other as possible, with cables kept as short as possible (see Figure G-2).

Use a power cable with a well-grounded shield. Use a shielded motor cable not exceeding 82 feet (25 m) in length. Arrange all grounds to maximize the end of the lead area in contact with ground (e.g. metal plate).

Use a shielded cable with braided shield and ground the maximum possible area of the shield. It is advisable to ground the shield by connecting the cable to the ground plate with metal clips (see Figure G-1).

# Electromagnetic Compatibility (EMC)

## ◆ Recommended EMC Filters

Drive Model CIMR-E7U	EMC Filter				
	Model Number	Current Rating	Weight lb. (kg)	Dimensions inches (mm)	Nominal Hp
<b>208-240 Vac</b>					
20P4	FS5972-10-07	10 A	2.43 (1.1)	5.500 x 13 x 1.875 (141 x 330 x 46)	0.5/0.75
20P7					1
21P5					1.5/2
22P2	FS5972-18-07	18 A	2.87 (1.3)	5.500 x 13 x 1.875 (141 x 330 x 46)	3
23P7	FS5973-35-07	35 A	3.09 (1.4)	5.500 x 13 x 1.875 (141 x 330 x 46)	5
25P5					7.5
27P5	FS5973-60-07	60 A	6.61 (3)	8 x 14 x 2.375 (206 x 355 x 60)	10
2011	FS5973-100-07	100 A	10.8 (4.9)	9.3125 x 16 x 3.125 (236 x 408 x 80)	15
2015					20
2018					25
2022	FS5973-130-35	130 A	9.48 (4.3)	3.5315 x 14.40625 x 7 (90 x 366 x 180)	30
2030					40
2037	FS5973-160-40	160 A	13.23 (6)	4.750 x 17.750 x 6.6875 (120 x 451 x 170)	50
2045	FS5973-240-37	240 A	24.25 (11)	5.125 x 24 x 9.4375 (130 x 610 x 240)	60
2055					75
<b>480 Vac</b>					
40P4	FS5972-10-07	10 A	2.43 (1.1)	5.500 x 13 x 1.875 (141 x 330 x 46)	0.5/0.75
40P7					1
41P5	FS5972-18-07	18 A	2.87 (1.3)	5.50 x 13 x 1.875 (141 x 330 x 46)	1.5/2
42P2					3
43P7					5
45P5					7.5
47P5					10
4011	FS5972-35-07	35 A	4.63 (2.1)	8.125 x 14 x 1.9375 (206 x 355 x 50)	15
4015	FS5972-60-07	60 A	8.82 (4)	9.250 x 16 x 2.50 (236 x 408 x 65)	25
4018					30
4030	FS5972-70-52	70 A	7.5 (3.4)	3 x 13 x 7.250 (80 x 329 x 185)	40/50
4037	FS5972-130-35	130 A	10.36 (4.7)	3.5 x 14.375 x 7 (90 x 366 x 180)	60
4045					75
4055					100

Drive Model CIMR-E7U	EMC Filter				
	Model Number	Current Rating	Weight lb. (kg)	Dimensions inches (mm)	Nominal Hp
4075	FS5972-170-40	170 A	13.23 (6)	4.750 x 17.750 x 6.6675 (120 x 451 x 170)	125
4090	FS5972-250-37	250 A	24.25 (11)	5.125 x 24 x 9.4375 (130 x 610 x 240)	150
4110					200

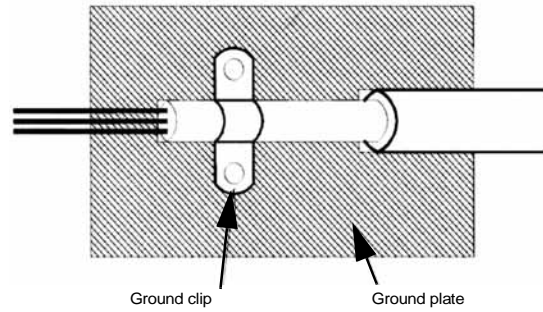

Fig G-1 Grounding Surface Layout

The grounding surfaces must be highly conductive bare metal. Remove any varnish or paint from grounding surfaces.

- Ground the cable shields at both ends.
- Ground the motor of the machine/application.

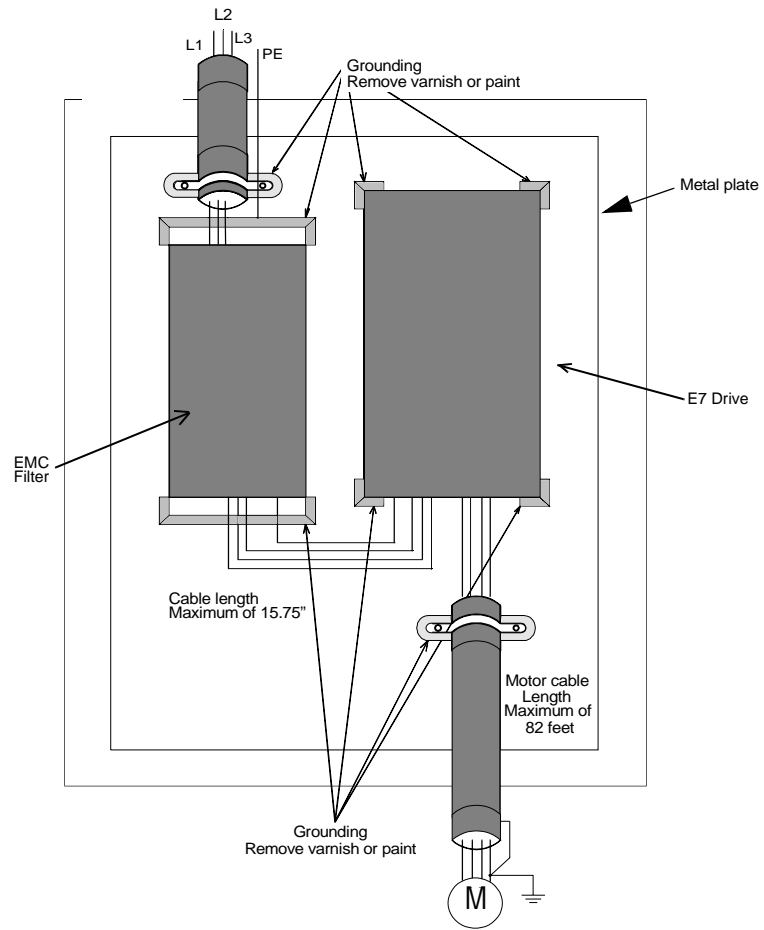

Fig G-2 EMC Filter Layout

Notes:

## A

A. TUNE menu.....	3-7, 3-14
AC Reactor .....	E-4
Accel/Decel	
Parameters .....	A-7
Time.....	5-25
Acceleration	
Stall Prevention Level during.....	5-40, 6-16, A-20
Time.....	5-25, A-7
Troubleshooting.....	6-16
Access Level.....	5-2, A-2
ADV menu.....	3-7, 3-13
Alarm Displays & Processing.....	6-8
ALARM Indicator .....	3-5
Altitude .....	C-4
Ambient Temperature .....	1-13, C-4
Analog Inputs	
Bias .....	5-33, 5-38, A-16
Connection Diagram.....	2-18
Control Circuit Terminals.....	2-14
Gain .....	5-33, 5-38, A-16
Parameters .....	A-4, A-9, A-16
Troubleshooting.....	6-14
Analog Outputs	
Bias .....	A-17, A-18
Connection Diagram.....	2-18
Control Circuit Terminals.....	2-14
Gain .....	A-17
Parameters .....	A-17, A-18
Annunciation Contacts .....	A-15
APOGEE FLN.....	iv, A-18, D-1
ASIC Faults .....	6-3
Auto	
AUTO Key .....	3-3
Mode.....	3-5
REF Indicator .....	3-2, 3-6
SEQ Indicator .....	3-2, 3-5
Auto Restart.....	5-44, A-21
Count Reset .....	5-44
Faults Covered.....	5-45
Max. Restart Time After Fault .....	5-44
Number of Attempts .....	5-44
Auto-Tuning	
Fault Displays and Processing.....	6-12
How to .....	5-59
Menu.....	3-7, 3-14
Motor Rated Current .....	A-25
Motor Rated Power .....	A-25

## B

BAS Communication .....	iii, A-18, D-1
Base Block	
After Fault.....	5-44, A-19
Circuit Fault .....	6-2
Minimum Time .....	5-7, A-19, B-4
Basic Programming.....	5-1 to 5-60
Baud Rate .....	6-10, A-18, D-2, D-4
Bias Adjustments .....	5-33, 5-38, A-16, A-17
Braking	
DC Injection.....	5-9, A-4
High-Slip.....	A-23
Branch Short Circuit Protection.....	E-2, E-3
Broken Belt (Undertorque detection).....	5-46

## C

Cable Length.....	2-11, 6-17
Capacitors .....	7-2
Capacity, Rated Output .....	C-2, C-3
Capacity Related Parameters .....	B-1
Carrier Frequency	
Error .....	6-11
Lower Limit .....	A-8
Parameters.....	A-8
Proportional Gain.....	A-8
Selection .....	A-8
Upper limit.....	A-8, B-3
Vs. Cable Length .....	2-11, 6-17
Characteristic Frequency .....	6-18
Charge Indicator (LED) .....	1-6, 2-2, 4-5, C-4
Circuit Breakers .....	2-9, E-2, E-3
Clearances .....	1-14
Coast to Stop .....	
.....	5-6, 5-32, 5-48, A-4, A-11, A-18, A-19, A-22
Com OPT Setup Parameters.....	5-32, A-11
Communications Modbus/Serial.....	D1 to D14
Errors (CPF).....	6-2 to 6-4, 6-8
Parameters.....	A-18
Components .....	1-5, 1-6, 3-2, 7-2
Configuration	
Electrical .....	1-5, 1-6, 2-18
Physical.....	1-7 to 1-10
Connections.....	2-2, 2-14, 2-18
Preventive Maintenance.....	7-3
Connectors	
Inspection.....	7-2
Sizing .....	2-3 to 2-7
Contactors	
Magnetic .....	E-4
Soft Charge .....	6-7, 6-10, 6-21

Control Circuit	
Characteristics .....	2-2, 2-11, 2-12
Connection Diagram.....	2-18
Analog Input Configuration.....	2-12
PCB.....	B-2
Inspecting .....	7-2
Spare Parts.....	F-2, F-3
Power Fuse .....	6-22
Terminal Functions .....	2-14
Wiring.....	2-12, 2-18
Precautions .....	2-19
Cooling.....	1-13
Fan .....	5-49, 6-23, 7-4, 7-5, A-22, A-25
Fins .....	6-7, 6-11, 7-2, 7-3, C-4
COPY Function.....	5-56 to 5-58
Faults .....	6-13
Parameters .....	A-25
Covers	
Protective .....	1-13
Removable.....	1-5, 1-6
Removing and Attaching .....	1-15, 1-16
CPU Faults.....	6-3
Critical Frequency Rejection .....	5-27, 6-18, 6-19, A-9
Current	
DC Injection Braking.....	5-9, A-4
Maximum Output (Overload Capacity).....	C-4
Monitor (Analog Output).....	2-14, A-17, A-26
Motor Rated (FLA).....	4-6, 5-31, 6-12, A-11, A-25, B-4
Rated Output .....	1-2, 1-11, 5-23, C-2, C-3
<b>D</b>	
DATA/ENTER Key .....	3-3, 5-54, A-24,
Usage .....	3-8, 3-15, 5-2, 6-15
Data Length.....	A-18, D1 to D14
Date Stamp Information.....	6-24
DC Braking.....	5-9, A-4
DC Bus Capacitors	
Inspecting.....	7-2
Preventive Maintenance .....	7-3
DC Bus Fuse	
Checking .....	6-21
Fault (PUF).....	6-6
Spare Parts.....	F-2, F-3
DC Bus Voltage	
Checking .....	6-20
Overvoltage .....	6-6, 6-9, C-4
Safety .....	i, 7-2
Undervoltage .....	6-7, 6-10, C-4
DC Injection Braking	
Current .....	5-9
Parameters .....	A-4
Start Frequency.....	5-9
Time at Start and Stop.....	5-10, 6-19, A-4
DC Reactor .....	2-8, C-2, E-4
DCInj to Stop.....	5-7
DDC.....	6-17
DDL, Waiting to RUN.....	5-8, A-4
Deadband, Prohibited (Jump) Frequency .....	5-27, A-9
Deceleration	
Stopping Method .....	5-6
Stop Indicator .....	3-6
Stall Prevention during .....	5-40, A-20
Time.....	5-25, A-7, C-4
Troubleshooting.....	6-6, 6-9, 6-17
Decimal, converting to hex.....	A-30
DECREASE Key.....	3-3, 5-37
Troubleshooting.....	6-14
Delay Timer Parameters .....	A-4, A-5
Diagnostics .....	6-1 to 6-24, D-14
Digital Inputs	
Connection Diagram.....	2-18
Control Circuit Terminals.....	2-12, 2-14
Parameters .....	A-12 to A-14
Sinking/Sourcing Modes .....	2-17
Troubleshooting.....	6-8, 6-14
Digital “Motor Operated Pot” .....	5-54, A-24
Digital Operator.....	3-1
Copy Function .....	5-56, 6-13, A-25
Data Display .....	3-2
Display Selection (Display Scaling).....	5-52, A-23
Drive Operation when Disconnected .....	5-55, A-24
Faults/Errors .....	6-2, 6-6, 6-14
Keys.....	3-3
LCD Brightness Adjustment .....	A-24
Lights.....	3-2, 3-5, 3-6
Mode Indicators.....	3-5
Mode Selection .....	3-3
Monitor Selection (At Power-up).....	5-51, A-23
Preventive Maintenance .....	7-3
Removing and Attaching.....	1-17, 1-18
Write-protected.....	5-56, 6-13, A-25
Digital Outputs	
Connection Diagram.....	2-18
Control Circuit Terminals.....	2-12, 2-14
Parameters .....	A-15
Dimensions .....	1-7 to 1-10, 1-14
Diode Module	
Inspection .....	7-2
Resistance Test .....	6-20, 6-21
Spare Parts .....	F-2, F-3
DIP Switch S1 .....	2-15, 5-35, D-3
Displaying Faults.....	3-10, 3-11, A-28, A-29
“Down Arrow” Key.....	3-3, 5-37, 6-14
DRIVE menu .....	3-7, 3-9
Drive Delay Time .....	5-9, A-4
Drive Mode, Troubleshooting .....	6-15
DriveWizard Software .....	iv, 5-58

## E

EEPROM.....	6-2, 6-11, 6-13, D-12
Elapsed Timer	
Monitor.....	3-9 to 3-11, A-27
Parameters.....	5-55, A-24, A-25, A-27 to A-29
Electrical Installation.....	2-1
EMC.....	G-1
Enclosed wall-mounted.....	1-5 to 1-9, C-4
Enclosure Style (type).....	1-2, 1-4, C-4
Energy Saving	
Parameters.....	A-7, B-3
Selection.....	5-24
Environment.....	1-13, 6-17, 7-3, C-4
ESC Key.....	3-3
External Faults (EF).....	2-14, 6-4, 6-8, A-14

## F

Factory Repair.....	Inside Back Cover
Fan, Heatsink Cooling	
Checking.....	6-23
Cumulative Operation Time Setting.....	A-25
Fuse, Checking.....	6-23
Inspecting.....	7-2, 7-3
Operation Delay Time.....	5-49, A-22
Operation Selection.....	5-49, A-22
Replacement Method.....	7-4, 7-5
Spare Parts.....	F-2, F-3
Troubleshooting.....	6-9
Fast-Stop Time.....	5-25, A-7, A-13, A-14
Faults	
Clearing.....	3-3, A-25
Covered by Auto Restart.....	5-45
Detection.....	6-2
Digital Output Signal.....	2-14, A-15
Effect on Auto Restart.....	5-45
History.....	3-11, A-29
Listing of.....	6-2
Reset.....	3-3, A-13, A-21
Trace.....	3-10, A-28
Feedback (PI Function).....	5-15, A-5
Differential.....	5-36, A-16
Loss Detection.....	5-18, A-6
Square Root Function Activation.....	5-23, A-6
Field Service.....	Inside Back Cover
Field Wiring.....	2-3, 2-12
FLA, Motor.....	4-6, 5-31, 6-12, A-11, B-3
Flash ID.....	A-27
Floating Point (Up/Down) Control.....	6-13, A-12
Forward Run/Stop Command.....	2-14, 2-18
Programming.....	5-4, 5-5, A-4
Frequency Detection.....	A-15
Frequency, Output	
Accuracy.....	C-4

Command Selection.....	5-4
Jump.....	5-27, 6-18, 6-19, A-9
Lower Limit.....	5-26, A-9
Max. Output.....	5-29, A-10, C-2
Meter (Analog Monitor).....	A-17
Mid Output.....	A-10
Minimum Output.....	6-15, A-10
Monitor (U1-02).....	A-26
Prohibited.....	5-27, 6-18, 6-19, A-9
Rated.....	C-2
Setting Resolution.....	C-4
Setting Signal (Speed Command).....	C-4
Troubleshooting.....	5-27, 6-19
Upper Limit.....	5-26, 6-19, A-9
Frequency Reference (speed command)	
Analog Input.....	2-12, 2-18, A-4, A-16
Bias.....	5-33 to 5-38, A-16
Gain.....	5-33 to 5-38, A-16
Loss Detection.....	5-43, A-21
Lower Limit.....	5-26, A-9
Preset References 1 to 4.....	A-8
Terminals.....	2-12, 2-14, 2-18
Upper Limit.....	5-26, 6-19, A-9
Setting Method Selection (MOP).....	5-54, A-24
Source (b1-01).....	3-6, 5-4, A-4
Full Load Amps (FLA).....	4-6, 5-31, 6-12, A-11, B-3
Fuse Blown Protection.....	6-6, 6-21 to 6-23, C-4
FWD Indicator.....	3-5

## G

Gain Adjustments.....	5-33, 5-38, A-16
Gate Drive PCBs	
Inspecting.....	7-2
Spare Parts.....	F-2, F-3
Ground Fault Function.....	5-45, 6-4, A-22
Ground Fault Interrupter (GFI)	
Troubleshooting.....	6-18
Grounding.....	2-11 to 2-14, 4-3, 6-17
Protection.....	C-4
Shield Wire.....	2-12, 2-18
Terminals.....	1-5, 1-6, 2-2 to 2-8

## H

Hand	
Frequency Reference Selection.....	5-3, A-4, A-27
Indicators.....	3-5, 3-6
HAND Key.....	3-4
Function Selection.....	A-25
Mode.....	3-4, 5-37
Troubleshooting.....	6-15
Hardware Protection Parameters.....	5-48, A-22
Harmonics, Mitigation.....	C-2, C-3
Heat Loss Data.....	1-11, 1-14

Heatsink Fan .....	5-49, 7-2, A-25, F-2
Hex, converting to decimal .....	A-30
High-Slip Braking .....	A-23
H/O/A (Hand/Off/Auto) .....	3-2 to 3-6
Horsepower, converting to kW .....	5-59
Humidity .....	1-13
Ambient Operating .....	C-4
Hunting Prevention	
Parameters .....	A-23
Troubleshooting .....	6-18

## I

IEC IP00 .....	1-2, 1-4, C-4
IEC IP20 .....	1-2, 1-4
IGBT (Transistor Module)	
Inspecting .....	7-2
Spare Parts .....	F-2, F-3
Testing .....	6-22
INCREASE Key .....	3-3, 5-54
Troubleshooting .....	6-14
Indicators, Mode .....	3-2, 3-5, 3-6, 4-5
Initialization .....	5-1, A-2
Mode Selection .....	5-3
Parameters .....	A-2, A-24
User .....	5-3, 5-54, A-24
Input	
Diodes .....	6-20, 6-21, 7-2, F-2
Fuses .....	2-9, 2-10, E-2, E-3
Multi-function Terminals	
Analog Inputs .....	
..... 2-12, 2-14, 2-18, 5-33, 5-38, A-4, A-9, A-16	
Digital Inputs .....	
..... 2-12, 2-14, 2-18, 6-18, 6-14, A-12 to A14	
Phase Loss Detection Level .....	6-6, A-22
Power .....	2-18, C-2
Terminal Status (U1-10) .....	A-26
Voltage .....	A-10, C-2, C-3
Setting .....	4-5, 5-22, A-10
Inspection	
Periodic .....	7-2
Receiving .....	1-3
Installation	
Electrical .....	2-1
Physical .....	1-1
Orientation & Clearances .....	1-14
Site .....	1-11, C-4
Integral Control (PI) .....	5-16
Interference .....	G-1

## J

Jog Frequency Reference .....	2-14, 2-18, A-8, A-12
Jump Frequency .....	5-27, 6-18, 6-19, A-9

## K

Keypad .....	3-1 to 3-16
kVA .....	1-11, C-2
Auto-Tuning .....	5-59, A-25
Error .....	6-11, 6-13
Parameters Affected by .....	B-3
Selection .....	A-24
kW, Converting from HP .....	5-59
kWH User Monitor Initialization .....	A-25

## L

Label, Control Terminals .....	2-2
Lamps, Indicator .....	3-2, 3-5, 3-6, 4-5
Language Selection .....	5-2, A-2
LCD Display .....	3-2, 3-8
LED (Indicators) .....	3-2, 3-5, 3-6, 4-5
Lights .....	3-2, 3-5, 3-6, 4-5
Line-borne Interference Interference .....	G-2
Line-to-Line Resistance, Motor .....	A-11
LonWorks .....	iv, 5-4, 5-5
Loss of Load .....	5-46, A-21

## M

Main Circuit	
Configuration .....	2-9, 2-10
Terminals .....	1-5, 1-6, 2-2 to 2-8, 2-18
Test Procedure .....	6-20
Wire Sizes and Connectors .....	2-3 to 2-7
Wiring Diagrams .....	2-18
Main Menu	
Functions .....	3-7
Structure .....	3-8 to 3-14
Maintenance .....	7-1
Mass, Drive (Weight) .....	1-3, 1-7 to 1-10
Master Frequency Reference Terminal Selection .....	
..... 5-39, A-16	
Master/Slave .....	D2 to D14
Mechanical Vibration .....	5-27, 6-18, 6-19, A-9
Mechanical Resonance .....	5-27, 6-18, 6-19, A-9
MENU Key .....	3-3, 3-7
Menu Trees, Digital Operator .....	3-8 to 3-14
Metasys .....	iii, iv, A-18, D-1
Meters .....	A-23
Modbus Communications .....	D-1 to D-14
Baud Rate .....	6-10, A-18
Terminals .....	2-12, 2-14
Mode Selection .....	3-3 to 3-6
Model Number .....	1-2 to 1-4
Modified Constants (Parameters) Menu .....	3-7, 3-14
Molded Case Circuit Breaker (MCCB) .....	E-2, E-3
Momentary Power Loss Ride-thru .....	
..... 5-11, 5-39, A-5, A-19, B-3, C-4	

Monitor	
Configuration .....	5-50
Parameter List .....	3-9, A-26, A-27
Power-On Monitor .....	5-51, A-23
User Monitor .....	5-51, A-23, A-24
MONITOR Key.....	3-3
MOP (Motor Operated Pot) Function .....	5-54, A-12, A-24
Reference Memory .....	A-9
Motor	
Auto-Tuning .....	5-59
Fault Displays & Processing .....	6-12
How to.....	5-59
Menu .....	3-7, 3-14
Motor Rated Current .....	A-25
Motor Rated Power .....	A-25
Direction.....	4-7, 6-16
No-Load Current (NLA) .....	5-32, A-11
Parameters .....	A-11
Pre-Heat Current .....	5-11, A-4
Protection .....	C-4
Overheat .....	A-19
Overload.....	A-19
Rated Current (FLA) ..	4-6, 5-31, 6-12, A-11, A-25, B-4
Rated Voltage .....	4-5, 4-6, A-10, C-2
Speed (U1-02) .....	3-9, A-26
Stopping Method Selection .....	4-7, 5-6, A-4
Temperature Input .....	A-16, A-19
Troubleshooting .....	6-15 to 6-19
Wiring.....	2-3, 2-11, 2-18
Mounting, Dimensions .....	1-7 to 1-10
Multi-function Analog Inputs.....	
.....	2-12, 2-14, 2-18, 5-33, 5-38, A-4, A-9, A-16
Multi-function Analog Outputs .....	2-12, 2-14, 2-18, A-17
Multi-function Digital Inputs .....	
.....	2-12, 2-14, 2-18, 6-8, 6-14, A-12 to A-14
Multi-function Digital Outputs.....	2-12, 2-14, 2-18, A-15
Multi-step Speed Reference (Preset Speed) .....	A-8

## N

Nameplate Information.....	1-3, 1-4
NEMA Type 1 .....	1-2, 1-4
Noise	
Cooling Fan .....	7-2, 7-3
Electrical .....	G-1
Filter .....	E-4, G-1
Mechanical .....	5-27, 6-18, 6-19, A-9
No-Load Current (NLA) .....	5-32, A-11

## O

OFF Key .....	3-4
Function during Auto Run .....	A-24
Off-delay Timer .....	A-5
On-delay Timer .....	5-9, A-4, A-5
Open Chassis.....	1-2, 1-4, 1-9, 1-10, 1-13, C-4
Operation	
Menu .....	3-7, 3-9
Status (U1-12).....	A-26
Operator Programming Errors (OPE) .....	6-11
Option	
Card Faults.....	6-3, 6-4
Communication Error Selection .....	5-32, A-11
LonWorks Communication Setup.....	5-32, A-11
Options (Peripheral Devices).....	E-4
Orientation, Drive .....	1-14
Oscillation.....	5-27, 6-18, 6-19, A-9
Output	
Current Monitor (U1-03) .....	2-14, A-17, A-26
Frequency (See Frequency, Output) .....	C-2 to C-4
Ground Fault Detection Selection .....	5-45, 6-4, A-22
Monitors.....	A-17, A-26, A-27
Power Monitor (U1-08) .....	A-26
Power Ratings.....	1-2, 1-3, 1-11, C-2 to C-4
Terminal Status Monitor (U1-11) .....	A-26
Transistors (IGBT)	
Inspecting .....	7-2
Spare Parts .....	F-2, F-3
Testing .....	6-22
Voltage Monitor (U1-06) .....	A-26
Outputs, Analog .....	2-14, 2-18, A-17, A-18
Outputs, Digital .....	2-12, 2-14, 2-18, A-15
Over Current (OC) .....	5-7, 5-45, 6-5
Overheat (OH)	
Alarms/Faults.....	5-45, 5-48, 6-5, 6-9, A-19, A-22, B-3
And Auto Restart .....	5-45
Cooling Fin (Heatsink) .....	5-49, 6-5, 6-9, C-4
Drive .....	1-13, A-22
Motor .....	6-5, 6-9, 6-17, A-19
Parameters .....	A-19, A-22
Pre-Alarm .....	6-9, A-22
Overload	
Alarms/Faults.....	5-45, 6-5, 6-6
And Auto Restart .....	5-45
Capacity .....	C-4
Drive .....	5-31, 6-5
Motor .....	6-5, A-15, A-19
Protection.....	A-19, C-4
Overtorque - See Torque Detection .....	5-46, A-21
Overvoltage Protection .....	5-28, 6-6, 6-9, C-4
And Auto Restart .....	5-45
DC Bus - See DC Bus Voltage .....	6-6, 6-9, C-4

# P

## Parameters

Accel/Decel (C1-01 - C1-11) .....	A-7
Analog Inputs (H3-02 - H3-13).....	A-16
Analog Outputs (H4-01 - H4-08).....	A-17, A-18
Auto-Tuning (T1-02 - T1-04) .....	A-25
Capacity Related .....	B-1
Carrier Freq (C6-02 - C6-05).....	A-8
Com OPT Setup (F6-01 - F6-05) .....	A-11
COPY Function (o3-01 - o3-02) .....	A-25
DC Braking (b2-01 - b2-09).....	A-4
Delay timers (b4-01 - b4-02).....	A-5
Digital Inputs (H1-01 - H1-05) .....	A-12 to A-14
Digital Outputs (H2-01 - H2-02).....	A-15
Energy Saving (b8-01 - b8-06) .....	A-7
Example of Changing.....	3-15, 3-16
Factory Reset (Initialize).....	A-2
Fault Restart (L5-01 - L5-03).....	A-21
Hdwe Protection (L8-01 - L8-19) .....	A-22
High Slip Breaking (n3-01 - n3-04).....	A-23
Hunting Prevention (n1-01 - n1-02).....	A-23
Initialization (A1-00 - A1-05).....	A-2
Jump Frequencies (d3-01 - d3-04) .....	A-9
Key Selections (o2-01 - o2-15) .....	A-24, A-25
Listing of .....	A-1 to A-29
Modified.....	3-7, 3-14
Monitor Select (o1-01 - o1-08) .....	A-23, A-24
MOP/Trim Control (d4-01 - d4-02) .....	A-9
Motor Overload (L1-01 - L1-05) .....	A-19
Motor Setup (E2-01 - E2-05) .....	A-11
PI Control (b5-01 - b5-30) .....	A-5, A-6
Preset Reference (Speeds) (d1-01 - d1-17) .....	A-8
Programming (Basic) .....	5-1 to 5-60
PwrLoss Ridethru (L2-01 - L2-05) .....	A-19
Ref Detection (L4-01 - L4-06).....	A-21
Reference Limits (d2-01 - d2-03) .....	A-9
S-Curve Acc/Dec (C2-01 - C2-02) .....	A-7
Sequence (b1-01 - b1-12).....	A-4
Serial Com Setup (H5-01 - H5-09) .....	A-18
Setting and Reading .....	3-7 to 3-16
Speed Search (b3-01 - b3-14) .....	A-5
Stall Prevention (L3-01 - L3-06).....	A-20
Torque Comp (C4-01 - C4-02).....	A-8
Torque Detection (L6-01 - L6-03) .....	A-21
Troubleshooting .....	6-14
User Limited Access (A2-01 - A2-32).....	A-2, A-3
V/f Pattern (E1-01 - E1-13).....	A-10
Parity - See Modbus Communications .....	D-2
Parts	
Ordering Replacement .....	F-1, Inside Back Cover
Spare.....	F-1 to F-3
Password	
Setting .....	A-2
Troubleshooting .....	6-14

## PCB

### Control

Inspecting .....	7-2
Spare Parts .....	F-2, F-3

### Gate Drive

Inspecting .....	7-2
Spare Parts .....	F-2, F-3

### Power

Inspecting .....	7-2
Spare Parts .....	F-2, F-3

### Terminal

Inspecting .....	7-2
Removing and Mounting .....	7-6
Spare Parts .....	F-2, F-3

## Peripheral Devices

AC and DC reactor .....	E-4
Magnetic Contactor .....	E-4
Molded-Case Circuit Breaker (MCCB).....	E-2
Noise filter .....	E-4
Troubleshooting .....	6-17

## Phase Loss Detection

Input.....	6-6, A-22
Phase-to-Phase Short .....	6-5, 6-6, 6-9

## Physical Installation - See Installation, Physical .....

## PI Function

Accel/Decel Time .....	5-19, A-6
Block Diagram.....	5-15
Feedback.....	5-15 to 5-18, 6-4, 6-9, A-6
Differential .....	5-15, A-16
Loss Detection Level.....	5-18, A-6
Loss Detection Time.....	5-18, A-6
Reference Missing Detection .....	5-18, A-5
Square Root Activation .....	5-23, A-6
Integral Limit Setting.....	5-16, A-5
Integral Time Setting .....	5-17, A-5
Maximum Boost Time .....	5-22, A-6
Offset Adjustment.....	5-17, A-5
Output .....	5-17, A-5
Gain Setting .....	5-18, A-5
Level Selection .....	5-17, A-5
Limit .....	5-17, A-5
Primary Delay Time Constant .....	5-17, A-5
Square Root Monitor .....	5-23, A-6
Parameters .....	5-15 to 5-23, A-5, A-6
Proportional Gain (PI) .....	5-14, A-5
Setpoint .....	5-15, A-6
Boost Setting .....	5-21, A-6
Display Scaling.....	5-20, A-6
Selection .....	5-19, A-6
Value .....	5-20, A-6

## Sleep

Delay Time .....	5-19, A-6
Function.....	5-19
Function Start Level .....	5-19, A-6
Input Source .....	5-21, A-6

Snooze	
Deactivation Level .....	5-21, A-6
Delay Time .....	5-21, A-6
Feedback Level .....	5-22, A-6
Function .....	5-21
Level .....	5-21, A-6
Square Root Gain .....	5-23, A-6
PI Mode .....	5-15, A-5
PI Monitors	
Feedback (U1-24).....	5-20, A-27
Output (U1-37).....	5-19, A-27
Setpoint (U1-38).....	5-20, A-27
PLC (Programmable Logic Controller)	
Serial Com. Using Modbus Protocol .....	D-2
Plenum Rated .....	1-13
Potentiometer (Connection) .....	2-12, 2-18
Power	
Energy Saving .....	5-24, A-7
Output, +15Vdc.....	2-14, 2-18
Loss Ride-thru .....	5-39, A-19, C-4
Module, Spare Parts .....	F-2, F-3
PCB	
Inspecting .....	7-2
Spare Parts .....	F-2, F-3
Supply Specifications.....	C-2, C-3
Power Factor Correction Capacitors .....	6-6
Pre-Operation Considerations .....	i to iv; 1-1, 2-1, 4-1
Preset Speeds .....	A-8
Preventive Maintenance .....	7-1
Programming	
Basic.....	5-1 to 5-60
Error (OPE) .....	6-11
Menu .....	3-7 to 3-16
Protective	
Functions.....	C-4
Enclosure.....	C-4
Parameters .....	A-22
PWM Frequency - See Carrier Frequency .....	A-8

## Q

Quick Setting Menu .....	3-7, 3-12
--------------------------	-----------

## R

Ramp to Stop .....	5-6, A-4
Rated Current, Motor .....	4-6, 5-31, 6-12, A-11, A-25, B-4
Rdy (Ready) .....	3-2
Reactors, Preventive Maintenance .....	7-3
READ .....	5-56, A-25
Ready Display .....	3-2
Receiving.....	1-3
REF Indicator .....	3-2, 3-5, 3-6
Reference Limits (see Frequency).....	5-26, 6-19, A-9

## Reference Selection

Auto .....	3-3
Hand.....	3-4
Reference Source .....	3-6, 5-4, A-4
Relays, Digital Output .....	2-12, 2-14, 2-18, 7-3, A-15
Replacement Parts.....	F-2, F-3
See Spare Parts Ordering.....	Inside Back Cover
RESET Key.....	3-3
Resistance, Motor Line-to-Line.....	A-11
Resonance .....	5-27, 6-18, 6-19, A-9
REV Indicator .....	3-5
Reverse Operation.....	5-8, A-4
Prohibiting .....	5-8, 6-16, A-4
Reverse Run/Stop command.....	2-14, 2-18
Ride-thru, Momentary Power Loss.....	
.....	5-11, 5-39, A-5, A-19, B-3, C-4
“Right Arrow” Key .....	3-3
RS-485/422 .....	5-5
Communication Wiring .....	D-3
Control Circuit Terminals .....	2-14, 2-18
Parameters .....	5-4, 5-32, A-4, A-18
Terminating Resistance.....	2-15, D-3
RTS Control Selection .....	A-18
Run Command	
During Programing .....	5-8, A-4
External, Troubleshooting .....	6-15
Selection .....	3-5, 4-6, 5-4, A-4
Source .....	3-4, 5-4, A-4
Terminals .....	2-14, 2-18
RUN Indicator.....	3-1, 3-6
Running	
Signal (output) .....	2-14
Stall Prevention during .....	5-42, A-20

## S

Safety Circuit .....	4-3, 4-4, 2-14, A-14
Scaling Display	
Digital Operator .....	5-52, A-23
PI Setpoint .....	5-20, A-6
Schematic Diagram.....	2-9, 2-10, 2-17, 2-18
S-Curve Characteristic .....	A-7
SEQ.....	3-2, 3-5
Sequence Parameters .....	A-4
Serial Communications.....	D-1 to D-14
Address .....	D-4
Baud Rate .....	6-10, A-18, D-2, D-4
Drive Node Address .....	D-4
Parameters .....	A-11, A-18, D-4
Run Command.....	5-4
Self-Diagnosis Function .....	D-14
Station Address.....	D-5
Stop bits .....	D-1
Serial Number .....	1-3
Setpoint (PI Function).....	5-20, A-27

Boost Setting .....	5-21, A-6
Display Scaling .....	5-17, A-6
Selection .....	5-15, 5-19, A-6
Value.....	5-20, A-6
SHIFT/RESET Key.....	3-3
Shield Wire Grounding.....	2-12, 2-18
Shipping Damage .....	1-3
Short Circuit Protection, Branch .....	E-2, E-3
Shunt Connector CN15 .....	2-16, A-18
Sinking/Sourcing Mode.....	2-17
Skip Frequency.....	5-27, 6-18, 6-19, A-9
Slave .....	D-2
Sleep Function.....	5-19, A-6
Snooze Function.....	5-21, 5-22, A-6
Soft Charge Contactor	
Alarm.....	6-10
Checking .....	6-21
Fault.....	6-7
Soft Charge Resistor	
Checking .....	6-21
Preventive Maintenance .....	7-3
Soft CLA Selection .....	A-22
Soft Start.....	A-7
Software Number (U1-14).....	A-27
Spare Parts.....	F-1 to F-3
SPEC .....	1-3, 1-4
Specifications .....	C-1
Design .....	1-4, A-25
General .....	C-4
Standard Drive	
208-240 VAC .....	C-2
480 VAC.....	C-3
Nameplate .....	1-3
Speed	
Agreement.....	5-46, A-15, A-21
Control Accuracy .....	C-4
Range.....	C-4
Speed Command - See Frequency Reference	
0-10Vdc.....	2-12, 2-14, 2-18, 4-9
4-20mA .....	2-12, 2-14, 2-18, 4-9
Limits .....	5-26, 6-19, A-9
Loss Detection.....	5-43, A-21
Selection.....	3-6, 4-6, 5-4, A-4
Setting Selection.....	5-54
Signal Polarity.....	2-12, 4-9
Troubleshooting .....	6-15, 6-16
Speed Reference, Multiple .....	
(Multi-step Speed Operation).....	A-8
Speed Search .....	5-11
Auto-Tuning .....	5-59
Parameters .....	A-5
Stall Prevention	
Parameters .....	5-40, A-20
Specifications .....	C-4
Troubleshooting .....	6-16

Start-up.....	4-1 to 4-9
Assistance .....	Inside Back Cover
Benchmark data .....	4-8
Preparation for .....	4-2
Procedure .....	4-5
STOP Indicator .....	3-2, 3-6
Stopping Method.....	4-7, 5-6, 5-7, A-4
Coast to Stop.....	5-5
Coast w/Timer .....	5-6
DcInj to Stop.....	5-7
External Fault from OPT Card.....	A-11
Modbus Communications.....	D-4
Ramp to Stop .....	5-6
Selection (OH) .....	5-48, A-22
Storage Temperature .....	C-4
Switching Frequency (Carrier Frequency) .....	2-11, A-8, B-3

## T

Technical Support .....	Inside Back Cover
Technical Training .....	Inside Back Cover
Temperature	
Ambient Operating .....	1-13, C-4
Ambient, Setting.....	A-22
Effect on Frequency Accuracy .....	C-4
Storage .....	C-4
Troubleshooting.....	6-17
Terminal PCB, Control	
Inspecting.....	7-2
Removing and Mounting .....	7-6
Spare Parts .....	F-2, F-3
Terminal A1 .....	2-14, 2-18, 5-33, A-16
Terminal A2 .....	2-14, 2-18, 5-35, 5-38, A-16
Terminal AM .....	2-14, 2-18, A-17, A-18
Terminal FM .....	2-14, 2-18, A-17, A-18
Terminal M1-M2 .....	2-14, 2-18, A-15
Terminal M3-M4 .....	2-14, 2-18, A-15
Terminal R+, R-, S+, S- .....	2-14, 2-18, D-3
Terminal S1, S2.....	2-14, 2-18, 5-3, 5-5
Terminals .....	S3 to S7 2-14, 2-18, A-12 to A-14
Terminal	
Arrangement .....	1-5, 1-6, 2-2
Configuration.....	2-2
Connections .....	2-18
Control Circuit.....	2-12, 2-14, 2-18
Main Circuit .....	2-3 to 2-8
Inspecting .....	7-2
Wiring.....	2-3 to 2-7
Screw Sizes.....	2-3 to 2-7
Terminating Resistance.....	2-15, D-3
Three-Wire Operation .....	5-5
Timers, Delay.....	A-5
Timers, Elapsed.....	5-55, A-25
Timer, On Delay.....	5-9, A-4
Torque Compensation .....	A-8

Torque Detection	
Faults .....	6-6
Level.....	5-46, 5-47
Nuisance.....	5-46
Parameters .....	A-21
Selection.....	5-46, 5-47
Time .....	5-46, 5-47
Torque Output.....	6-16
Transformers, Preventive Maintenance.....	7-3
Transistor Module	
Inspecting .....	7-2
Spare Parts.....	F-2, F-3
Test .....	6-22
Trim Control Level.....	A-9
Troubleshooting.....	6-1 to 6-24
Two-Wire Operation.....	5-5
Twelve-pulse rectification .....	2-9, C-2, C-3

## U

U1 Monitor List.....	3-9, A-26, A-27
U2 Fault Trace List.....	3-10, A-28
U3 Fault History List.....	3-11, A-29
UL File Number .....	1-3
Undertorque Detection (UL) .....	5-46, 5-47
Alarm/Fault .....	6-7, 6-10
Parameters .....	A-21
Undervoltage (UV)	
Alarm/Fault .....	6-7, 6-10
Detection Level .....	A-19
Protection .....	C-4
“Up Arrow” Key .....	3-2, 3-3
Up/Down Function.....	6-13, A-12
User Initialization .....	5-3, 5-54, A-24
User Parameters.....	A-2, A-3
User Monitor .....	5-51, A-23, A-24

## V

Ventilation .....	1-3, 1-14
Verify Copy Function.....	5-56
Error .....	5-58, 6-13
VERIFY Menu .....	3-7, 3-14
V/f Pattern .....	5-28
Faults/Errors.....	6-5, 6-11
Parameters .....	A-10
Selection.....	5-28
Vibration, Maximum .....	C-4

Voltage	
Allowable fluctuation .....	6-7, 6-10, C-2, C-3
Base .....	A-10
Drop Calculation.....	2-7
Input - See Input Voltage .....	A-10
Maximum Output .....	C-2, C-3
Rating, Drive .....	1-4, C-2, C-3
Related Parameters .....	A-10

## W

Watchdog Timer.....	6-3
Weight.....	1-3, 1-7 to 1-10
Wire	
Clamping Torque .....	2-3 to 2-7
Gauge.....	2-3 to 2-7
Length.....	2-11, 6-17
Size .....	2-3 to 2-7
Wiring, Electrical Installation .....	2-1
Control Circuit.....	2-12
Diagram .....	2-18
Distances.....	2-11
Field Diagram .....	2-20
Ground.....	2-11, G-2
Main Circuit	
Configurations .....	2-9, 2-10
Terminals .....	2-3 to 2-7
Shielded Twisted-Pair Wires .....	2-19
Sinking/Sourcing .....	2-17
Three-Wire Control.....	5-3 to 5-5
Two-Wire Control .....	5-3 to 5-5

## Z

Zero speed output signal.....	A-15
-------------------------------	------



## **Drives Technical Support in USA and Canada**

Technical Support for Inverters and Drives is available by phone as follows:

Normal: Monday through Friday during the hours of 8 a.m. to 5:00 p.m. C.S.T.  
Emergency: After normal hours, 7 days a week including weekends and holidays

To contact Drives Technical Support, please call 1-800-YASKAWA (927-5292).  
From the menu, dial 2 for Inverter and Drive Products, then 5 for Technical Support.

Drives Technical Support can also be reached by e-mail at [DriveSupport@yaskawa.com](mailto:DriveSupport@yaskawa.com).  
Support information, such as technical manuals, FAQs, instruction sheets and software downloads are available at our website, [www.drives.com](http://www.drives.com).

When calling for technical support, please have the following materials available:

- The appropriate Technical Manual in hand because the support associate may refer to this
- Complete nameplate information from the drive and the motor.  
(Confirm that Drive Nameplate Output amps is greater than Motor Nameplate amps)
- A list of your parameter settings
- A sketch of the electrical powertrain, from AC line to motor, including filters and disconnects

## **Field Service, Start Up Assistance, Factory Repair, Replacement Parts, and Other Support**

Contact Drives Technical Support for help with any of these needs.

## **Technical Training**

Training is conducted at Yaskawa training centers, at customer sites, and via the internet.  
For information, visit [www.drives.com](http://www.drives.com) or call 1-800-YASKAWA (927-5292).  
From the phone menu, dial 2 for Inverter and Drive Products, then 4 for Product Training.

## **Support in Other Countries**

Yaskawa is a multi-national company with offices and service representation around the world.  
To obtain support, always contact the local distributor first for guidance and assistance.  
Contact the closest Yaskawa office listed for further assistance.

**YASKAWA ELECTRIC AMERICA, INC.**

Drives Division  
16555 W. Ryerson Rd., New Berlin, WI 53151, U.S.A.  
Phone: (800) YASKAWA (800-927-5292) Fax: (262) 782-3418  
Internet: <http://www.drives.com>

**YASKAWA ELECTRIC AMERICA, INC.**

Chicago-Corporate Headquarters  
2121 Norman Drive South, Waukegan, IL 60085, U.S.A.  
Phone: (800) YASKAWA (800-927-5292) Fax: (847) 887-7310  
Internet: <http://www.yaskawa.com>

**MOTOMAN INC.**

805 Liberty Lane, West Carrollton, OH 45449, U.S.A.  
Phone: (937) 847-6200 Fax: (937) 847-6277  
Internet: <http://www.motoman.com>

**YASKAWA ELECTRIC CORPORATION**

New Pier Takeshiba South Tower, 1-16-1, Kaigan, Minatoku, Tokyo, 105-0022, Japan  
Phone: 81-3-5402-4511 Fax: 81-3-5402-4580  
Internet: <http://www.yaskawa.co.jp>

**YASKAWA ELETRICO DO BRASIL COMERCIO LTDA.**

Avenida Fagundes Filho, 620 Bairro Saude Sao Paulo-SP, Brasil CEP: 04304-000  
Phone: 55-11-5071-2552 Fax: 55-11-5581-8795  
Internet: <http://www.yaskawa.com.br>

**YASKAWA ELECTRIC EUROPE GmbH**

Am Kronberger Hang 2, 65824 Schwalbach, Germany  
Phone: 49-6196-569-300 Fax: 49-6196-888-301

**MOTOMAN ROBOTICS AB**

Box 504 S38525, Torsas, Sweden  
Phone: 46-486-48800 Fax: 46-486-41410

**MOTOMAN ROBOTEC GmbH**

Kammerfeldstrabe 1, 85391 Allershausen, Germany  
Phone: 49-8166-900 Fax: 49-8166-9039

**YASKAWA ELECTRIC UK LTD.**

1 Hunt Hill Orchardton Woods Cumbernauld, G68 9LF, Scotland, United Kingdom  
Phone: 44-12-3673-5000 Fax: 44-12-3645-8182

**YASKAWA ELECTRIC KOREA CORPORATION**

Paik Nam Bldg. 901 188-3, 1-Ga Euljiro, Joong-Gu, Seoul, Korea  
Phone: 82-2-776-7844 Fax: 82-2-753-2639

**YASKAWA ELECTRIC (SINGAPORE) PTE. LTD.**

Head Office: 151 Lorong Chuan, #04-01, New Tech Park Singapore 556741, Singapore  
Phone: 65-282-3003 Fax: 65-289-3003

**TAIPEI OFFICE (AND YATEC ENGINEERING CORPORATION)**

10F 146 Sung Chiang Road, Taipei, Taiwan  
Phone: 886-2-2563-0010 Fax: 886-2-2567-4677

**YASKAWA JASON (HK) COMPANY LIMITED**

Rm. 2909-10, Hong Kong Plaza, 186-191 Connaught Road West, Hong Kong  
Phone: 852-2803-2385 Fax: 852-2547-5773

**BEIJING OFFICE**

Room No. 301 Office Building of Beijing International Club,  
21 Jianguomanwai Avenue, Beijing 100020, China  
Phone: 86-10-6532-1850 Fax: 86-10-6532-1851

**SHANGHAI OFFICE**

27 Hui He Road Shanghai 200437 China  
Phone: 86-21-6553-6600 Fax: 86-21-6531-4242

**SHANGHAI YASKAWA-TONJI M & E CO., LTD.**

27 Hui He Road Shanghai 200437 China  
Phone: 86-21-6533-2828 Fax: 86-21-6553-6677

**BEIJING YASKAWA BEIKE AUTOMATION ENGINEERING CO., LTD.**

30 Xue Yuan Road, Haidian, Beijing 100083 China  
Phone: 86-10-6232-9943 Fax: 86-10-6234-5002

**SHOUGANG MOTOMAN ROBOT CO., LTD.**

7, Yongchang-North Street, Beijing Economic & Technological Development Area,  
Beijing 100076 China  
Phone: 86-10-6788-0551 Fax: 86-10-6788-2878

**YEA, TAICHUNG OFFICE IN TAIWAN**

B1, 6F, No.51, Section 2, Kung-Yi Road, Taichung City, Taiwan, R.O.C.  
Phone: 886-4-2320-2227 Fax: 886-4-2320-2239