

DANGER

Voltage is present on capacitors for five minutes after input circuit is open. Risk of electric shock and/or electrical energy-high current levels.

WARNING

Disconnect electrical supply before servicing the electrical system.

Do not change the wiring while power is applied to the circuit.

Do not check signals during operation.

WARNING

Refer to this manual for connection of circuits and the rating of auxiliary circuits.

Be sure to ground AF-3000 using the ground terminal G(E).

Never connect main circuit output terminals T1(U), T2(V), T3(W) to AC main circuit power supply.

CAUTION

Separate motor overcurrent, overload and overheating protection is required to be provided in accordance with CANADIAN ELECTRICAL CODE, PART I and NEC.

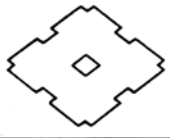

This instruction manual is composed of 2 sections: The first section describes handling, wiring, operation, maintenance/inspection, troubleshooting and specifications of the AF-3000 Digital Compact Inverter. The second outlines the digital operator performance, constants, operation, etc.

Before using the AF-3000, a thorough understanding of this manual is recommended for daily maintenance, inspection and troubleshooting.

In this manual, "constant (No. [])" indicates the item number of control constant set by digital operator.

DANGER

Voltage is present on capacitors for five minutes after input circuit is open. Risk of electric shock and/or electrical energy-high current levels.

WARNING

Disconnect electrical supply before servicing the electrical system.

Do not change the wiring while power is applied to the circuit.

Do not check signals during operation.

WARNING

Refer to this manual for connection of circuits and the rating of auxiliary circuits.

Be sure to ground AF-3000 using the ground terminal G.

Connect the motor to output terminals T1, T2, T3. Connect an AC power supply to input terminals L1, L2, L3 (for 240 V single-phase series, connect only to L1 and L2).

CAUTION

Separate motor overcurrent, overload and overheating protection is required to be provided in accordance with CANADIAN ELECTRICAL CODE, PART I and NEC.

	Page
1. AF-3000 INVERTER MAIN UNIT	1
1.1 PARTS NAMES OF AF-3000	1
1.2 RECEIVING	2
1.2.1 Nameplate Data	2
1.2.2 Type Designation	3
1.3 INSTALLATION	4
1.3.1 Transportation	4
1.3.2 Mounting Space	4
1.3.3 Location	5
1.4 WIRING	6
1.4.1 Terminal Cover Mounting/Removing and Terminal Position	6
1.4.2 Standard Wiring Diagram	8
1.4.3 Main Circuit	10
1.4.4 Control Circuit	20
1.5 OPERATION	24
1.5.1 Pre-operation Check	24
1.5.2 Pre-operation Setting	25
1.5.3 Test Run Method	27
1.5.4 Inverter Status Display LEDs	29
1.5.5 Digital Operator Display	30
1.5.6 Check Points at Test Run	31
1.6 MAINTENANCE	32
1.6.1 Periodical Inspection	32
1.6.2 High Voltage Test	33
1.7 FAULT DISPLAY AND TROUBLESHOOTING	34
1.7.1 Checking of Causes	34
1.7.2 Alarm Display and Contents	38
1.7.3 Corrective Action for Motor Faults	40
1.8 SPECIFICATIONS	42
1.8.1 Specifications	42
1.8.2 Dimensions in inches (mm)	50
2. DIGITAL OPERATOR (OS-9)	51
2.1 DIGITAL OPERATOR MOUNTING/REMOVING	51
2.2 DESCRIPTION OF DIGITAL OPERATOR DISPLAY AND OPERATING SECTIONS	52
2.3 FUNCTION/CONSTANT SETTING	54
2.3.1 DRIVE Mode and PRGM (Program) Mode	54
2.3.2 Constant Reading and Setting	56
2.3.3 Precautions on Constant Setting	58
2.4 DIGITAL OPERATOR OPERATION EXAMPLE	60
2.5 CONSTANT INITIALIZATION AND WRITE-IN PROHIBIT	62
2.5.1 Constant Initialization (Operation to return to factory setting)	62
2.5.2 Constant Write-in Prohibit (Only constant reading possible)	63
2.6 CORRECTIVE FUNCTION	64
2.6.1 Adjustment of Frequency Setting Value, Output Frequency Bias (No. 23) and Gain (No. 22)	64

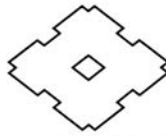
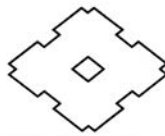

	Page
2.6.2 Calibration of Frequency Meter	66
2.7 MONITOR	68
2.7.1 Typical Monitor Contents and Display (DRIVE Mode)	68
2.7.2 Monitoring of Fault Contents	69
2.8 FUNCTION/CONSTANT LIST	70
2.8.1 First Functions (Constant Nos. 00 to 19)	70
2.8.2 Second Functions (Constant Nos. 20 to 31)	73
2.8.3 Third Functions (Constant Nos. 30 to 59)	75
2.9 DESCRIPTION OF FUNCTIONS AND CONSTANTS	79
• PASSWORD SETTING	79
• OPERATION MODE SELECTION	80
• 4-STEP SPEED CHANGE	82
• S-CURVE PATTERN SELECTION	83
• V/f CHARACTERISTIC SETTING	84
• JOG OPERATION	86
• ACCEL/DECEL TIME SETTING	87
• OUTPUT FREQUENCY CONTROL (GAIN/BIAS)	88
• ELECTRONIC THERMAL OVERLOAD PROTECTION	88
• MULTIFUNCTION ANALOG OUTPUT MONITOR SETTING	90
• OUTPUT FREQUENCY LIMIT	91
• MOTOR STALL PREVENTION FUNCTION	92
• FULL-RANGE AUTOMATIC TORQUE BOOST	94
• MULTIFUNCTION CONTACT INPUT FUNCTION SELECTION	94
• MULTIFUNCTION PHOTO-COUPLER OUTPUT FUNCTION.....	98
• DC INJECTION BRAKING	99
• FREQUENCY/CURRENT METER CALIBRATION.....	100
• OVERTORQUE DETECTION FUNCTION	101
• CARRIER FREQUENCY	102
• ARBITRARY SPEED DETECTION LEVEL ADJUSTMENT AND SELECTION	103
• FREQUENCY JUMP FUNCTION SETTING	105
• CONSTANTS EFFECTIVE FOR REDUCTION OF MACHINE VIBRATION OR SHOCK.....	106
• SPEED SEARCH FUNCTION.....	107
• CONTINUOUS OPERATION AT MOMENTARY POWER LOSS.....	109
• AUTOMATIC RESTART FUNCTION AFTER A FAULT.....	112
• ACCEL/DECEL HOLD COMMAND.....	114
2.10 PROTECTIVE FUNCTIONS	116
2.11 WARNING AND SELF-DIAGNOSIS FUNCTIONS	120

CAUTION

All the potentiometers of AF-3000 have been adjusted at the factory. Do not change their settings unnecessarily.

Do not make withstand voltage tests on any part of the AF-3000 unit. It is electronic equipment using semiconductors and vulnerable to high voltage.

Make sure to tighten screws on the main circuit and control circuit terminals. Refer to installation instructions for torque values. See par. 1.5.3 “(5) Wire and terminal screw sizes.”

Handle with care so as not to damage the inverter during transportation.

Do not pick up by the front cover or the unit cover (plastic portion). Use the die-cast portion.

ADVERTISSEMENT

Des tensions subsistent aux bornes des condensateurs pendant cinq minutes après l'ouverture de circuit d'entrée.

Couper l'alimentation avant d'entreprendre le dépannage du système électrique.

ATTENTION

Une protection distincte contre les surintensités, la surcharge et la surchauffe de moteur doit être fournie conformément AU CODE CANADIEN DE L'ÉLECTRICITÉ PREMIER PARTIE et LE NATIONAL DE L'ÉLECTRICITÉ.

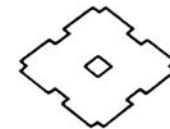

WARNING

Twist wires together before inserting in grounding terminal.

CAUTION

Separate motor overcurrent, overload and overheating protection is required to be provided in accordance with CANADIAN ELECTRICAL CODE, PART I and NEC.

Use 75°C copper wires only.

Low voltage terminals shall be wired with Class I Wiring.

When mounting units in an enclosure, remove the top, bottom and terminal covers.

ADVERTISSEMENT

Enroulez les fils ensemble avant de les introduire dans la borne.

Des tensions subsistent aux bornes des condensateurs pendant cinq minutes après l'ouverture de circuit d'entrée.

Couper l'alimentation avant d'entreprendre le dépannage du système électrique.

ATTENTION

Une protection distincte contre les surintensités, la surcharge et la surchauffe de moteur doit être fournie conformément AU CODE CANADIEN DE L'ÉLECTRICITÉ PREMIER PARTIE et LE NATIONAL DE L'ÉLECTRICITE.

The AF-3000 is an ultra-compact, all-digital inverter which provides low noise operation.

Two types are available : 1) with digital operator or 2) with drive status indicating plate (indicating plate).

The digital operator allows maximum utilization of the drive by providing access to the inverter's program constants and operation variables.

The model with the indicating plate provides status and fault codes while preventing unauthorized access to the programming constants. It is also useful for those applications where the programming operator can be moved from one unit to another.

1.1 PARTS NAMES OF AF-3000

- With digital operator

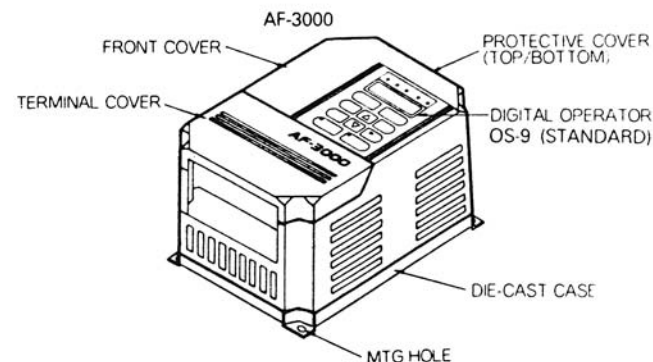

- With indicating cover

The indicating cover shown to the right will be mounted in place of the digital operator which is installed in the unit.

INDICATING COVER

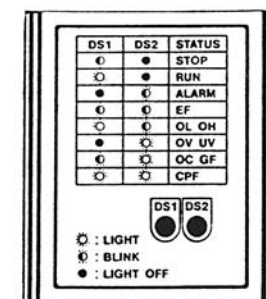

SPECIFICATIONS

1.8.2 Dimensions in inches (mm)

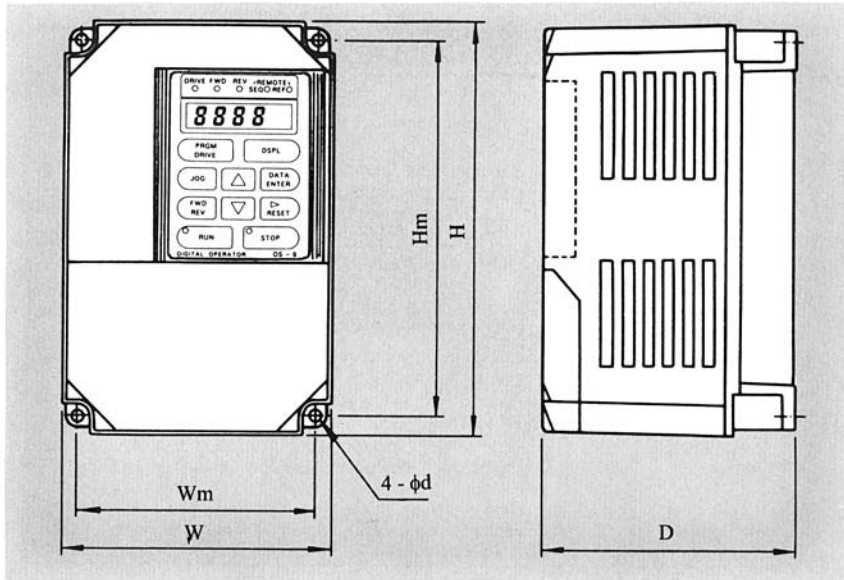

Voltage	Ratings			Dimensions						Weight
	HP	kW		H	Hm	W	Wm	D	d	
200-230 3-Phase Input	1/8-1/2	0.1-0.4	in mm	5.91 150	5.43 138	4.13 105	3.66 93	3.94 100	0.20 5.0	2.43 lb 1.1 kg
	1-2	0.75-1.5	in mm	5.91 150	5.43 138	5.51 140	5.04 128	5.47 139	0.20 5.0	4.41 lb 2.0 kg
	3-5	2.2-3.7	in mm	7.87 200	7.32 186	5.51 140	4.96 126	6.69 170	0.22 5.5	7.28 lb 3.3 kg
200-230 1-Phase Input	1/8-1/2	0.1-0.4	in mm	5.91 150	5.43 138	5.51 140	5.04 128	5.47 139	0.20 5.0	4.9 lb 2.2 kg
	1-2	0.75-1.5	in mm	7.87 200	7.32 186	5.51 140	4.96 126	6.69 170	0.22 5.5	6.6 lb 3.0 kg
	3-5	2.2-3.7	in mm	7.87 200	7.28 185	7.48 190	6.89 175	7.48 190	0.24 6.0	11.0 lb 5.0 kg
380-460 3-Phase	1/8-1/2	0.2-0.4	in mm	7.87 200	7.32 186	5.51 140	4.96 126	4.72 120	0.22 5.5	4.41 lb 2.0 kg
	1-2	.75-1.5	in mm	7.87 200	7.32 186	5.51 140	4.96 126	6.69 170	0.22 5.5	6.61 lb 3.0 kg
	3-5	2.2-3.7	in mm	7.87 200	7.28 185	7.48 190	6.89 175	7.48 190	0.24 6.0	10.14 lb 4.6 kg

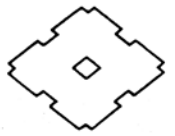

DIGITAL OPERATOR

2. DIGITAL OPERATOR (OS-9)

The digital operator (OS-9), mounted directly on the inverter, is an AF-3000 exclusive use operation panel which can perform operation, change the control constants and monitor operation status.

2.1 DIGITAL OPERATOR MOUNTING/REMOVING

The digital operator can be mounted and removed in the following procedures. It cannot be mounted or removed during current conduction. Be sure to turn off the inverter power supply and mount/remove it after the charge lamp is extinguished. Unless otherwise, it may cause malfunction.

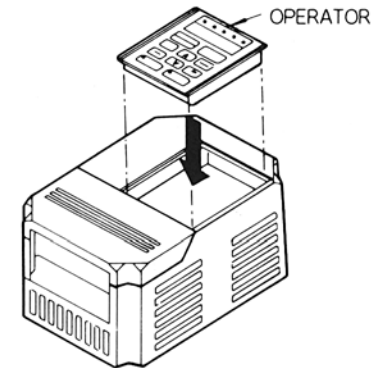

How to mount operator

Insert the operator in the direction of the arrow mark until it goes to the end.

How to remove operator

(1) Press in the direction of ① and, at the same time, lift it in the direction of ③ to remove the terminal cover.

(2) Lower the lever in the direction of ③ and insert the minus driver in section A. Then lift the operator in the direction of ④ to remove it.

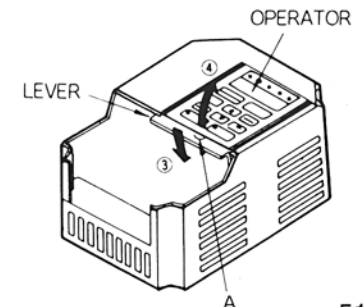
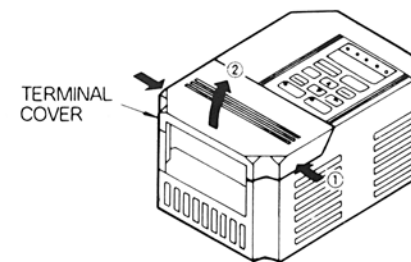

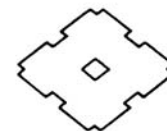

DIGITAL OPERATOR

2.2 DESCRIPTION OF DIGITAL OPERATOR DISPLAY AND OPERATING SECTIONS

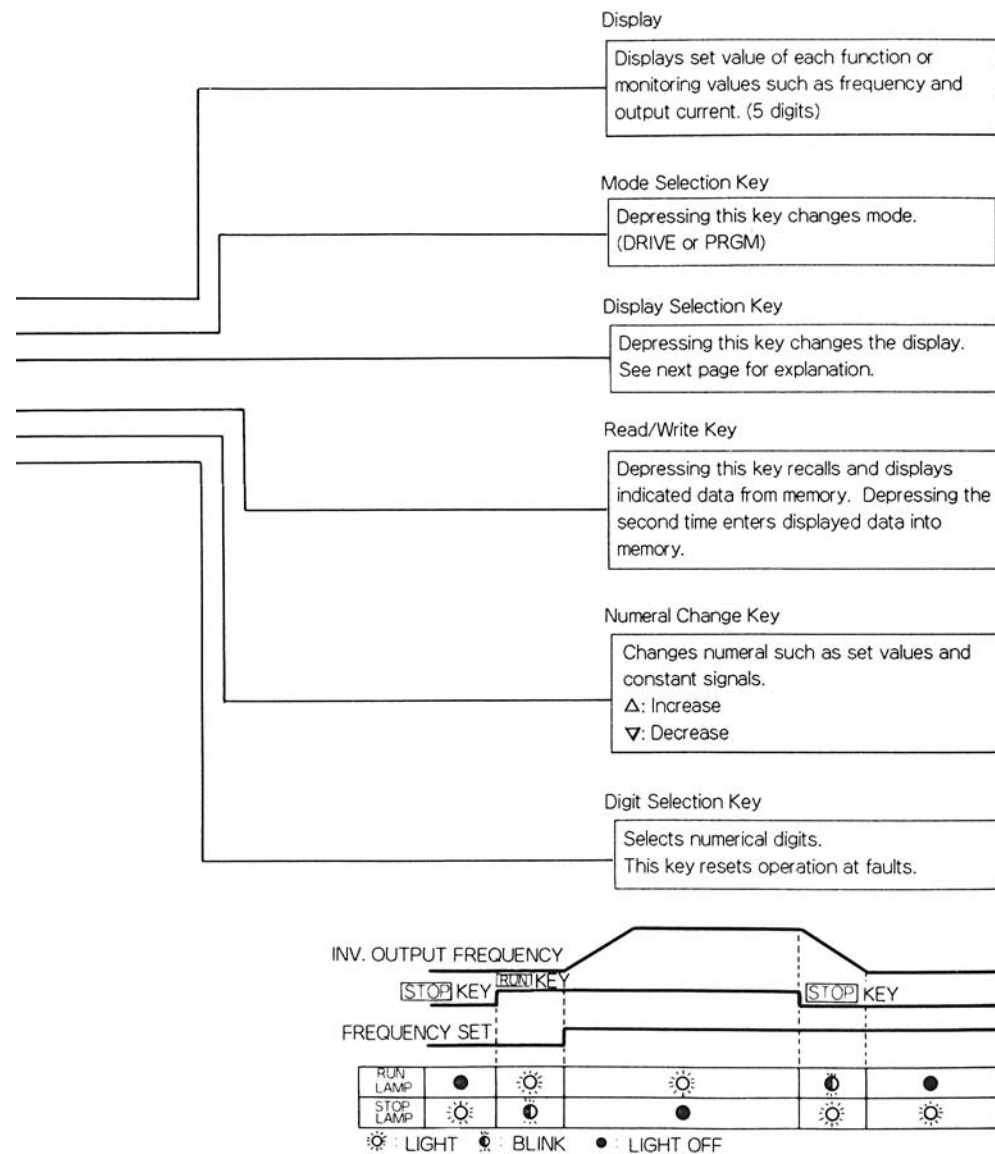
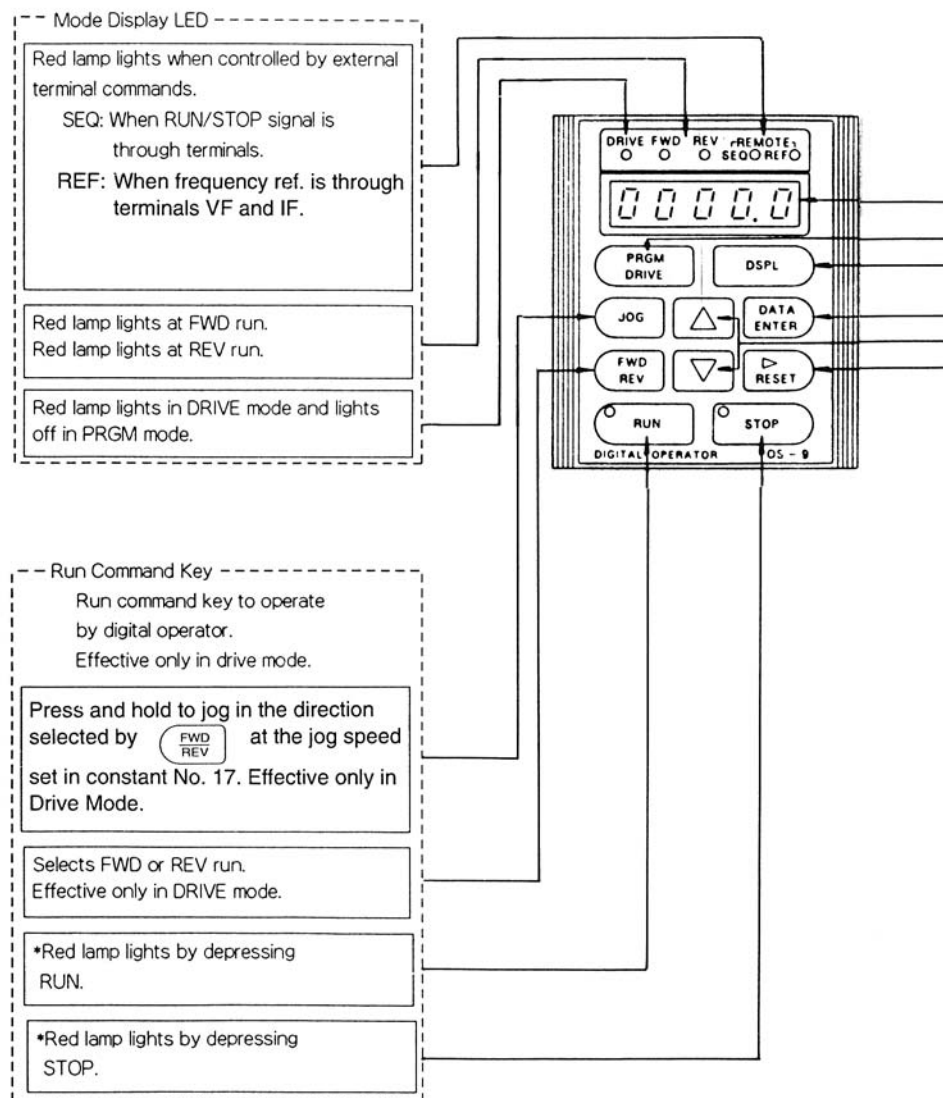

* RUN or STOP lamp changes in accordance with the operations

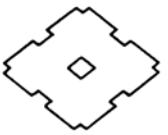





2.3 FUNCTION/CONSTANT SETTING

2.3.1 DRIVE Mode and PRGM (Program) Mode

Selection of DRIVE mode or PRGM mode can be performed by using the  key when the inverter is stopped. When function selection or a change of set value is required, switch to the PRGM mode.

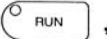
- Operation is enabled.

DRIVE mode

- An operation can be performed by , ,  or  keys.
- Frequency reference value can be changed during running.

PRGM mode

- Program (function selection, constant setting) can be changed. Operation is not enabled.

Display Contents of DRIVE Mode and PRGM Mode

- Display contents of the digital operator differ according to selected mode (PRGM/DRIVE).
- The constant group to be displayed is changed each time display selection key  is depressed.
- If a fault occurs, the contents are displayed. Additionally, since the contents of the latest fault are stored, maintenance, inspection or troubleshooting can be performed quickly by checking the contents by the digital operator.

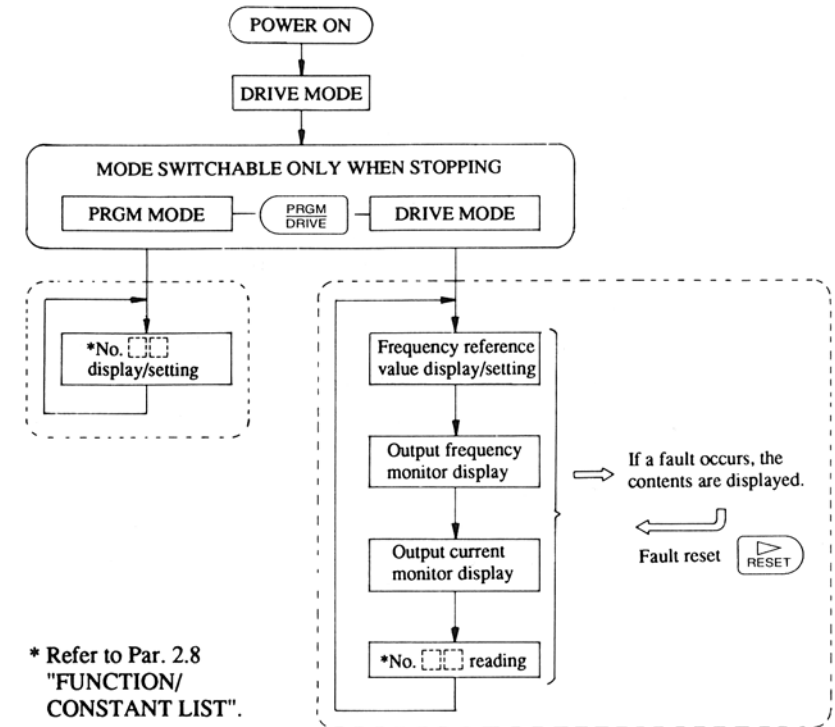

* Refer to Par. 2.8 "FUNCTION/CONSTANT LIST".

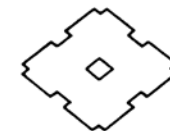

2.3.2 Constant Reading and Setting

The AF-3000 has various functions for the optimum operation. The first functions are those basic to drive motors. The second are for basic applications. The third are more advanced application functions. Use it with the set values according to the load conditions or operation conditions of the matching machine. Control constants are read or set by the digital operator. Set constant (No.00) as follows:

- (1) 1st functions (constant Nos.00 to 19) can be set/read :
No.00 = 1 (Factory setting)
- (2) 1st and 2nd functions (constant Nos.00 to 29) can be set/read :
No.00 = 2
- (3) 1st, 2nd and 3rd functions (constant Nos.00 to 59) can be set/read :
No.00 = 3

<Typical setting>

- The following shows an example where acceleration time (No.09) is changed from 10 seconds to 5 seconds.
- Other constants can be changed in the same operation.

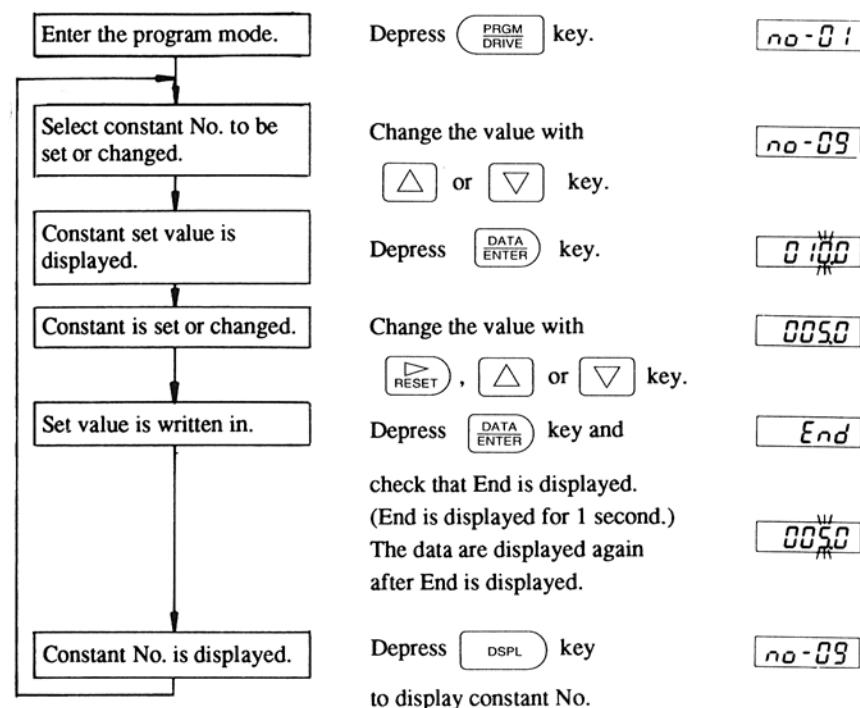

Note : Check that is displayed for each constant setting. Constants cannot be changed simultaneously.

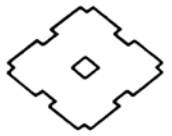

2.3.3 Precautions on Constant Setting

- Perform constant setting securely.
Improper setting may cause functions not to operate or protective function to operate.
- Record the constants of which setting has been changed.
Recording the final setting of constants is effective for maintenance or early troubleshooting. Refer to the Par. 2.8 "FUNCTION/CONSTANT LIST" which has a column for entering setting of constants on page 70.
- Change control constants little by little.
Do not change the motor control constant setting such as V/f maximum output frequency, etc. rapidly. Change it little by little, checking the motor current or load machine status. Changing setting very rapidly may affect the inverter or machine.

• Setting Error

In the following cases, the set value blinks for 3 seconds and the data before changing are returned.

- When a value exceeding the setting range is set
- If the following condition is not satisfied in the multifunction input selection constant setting :
Multifunction input selection 1 (No. 32)
Multifunction input selection 2 (No. 33)
- If the following conditions are not satisfied in the V/f constant setting :
Max. output frequency (No. 02) \geq Max. voltage frequency (No. 04) $>$ Intermediate output frequency (No.05) \geq Min. output frequency (No. 07)
For the following setting, intermediate output frequency voltage (No. 06) is disregarded :
Intermediate output frequency = Min. output frequency.
For details, refer to "V/f CHARACTERISTIC SETTING" on page 84.
- If the following condition is not satisfied in the frequency reference constant setting :
Set frequency reference (Nos. 13 to 17) \leq Max. output frequency (No. 02) \times Output frequency upper limit value (No. 24)
For details, refer to "V/f CHARACTERISTIC SETTING" on page 84 and "OUTPUT FREQUENCY LIMIT" on page 91.
- If the following condition is not satisfied in the frequency reference upper / lower limit value setting :
Frequency reference lower limit value (No. 25)
 \leq Frequency reference upper limit value (No. 24)

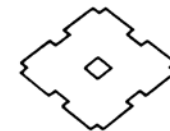

2.4 DIGITAL OPERATOR OPERATION EXAMPLE

The following shows an example of digital operator operation.

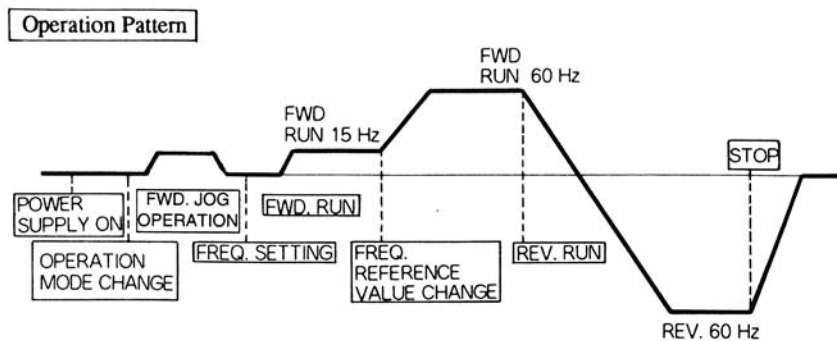

Operation	[Description]	[Key Operation]	[Digital Operator] Display
Turn ON power supply	<ul style="list-style-type: none"> Frequency reference value is displayed. Check rotating direction. (FWD is default on power ON.) 		F0000 LED lamp [FWD] lights.
Change operation mode.	<ul style="list-style-type: none"> PRGM mode is selected. Constant (No.1) data is displayed. Set value is changed. Set value is written in. (End is displayed for 1 second.) The data are displayed again after End is displayed. 	PRGM DRIVE DATA ENTER RESET Δ ▽ DATA ENTER	no-01 0000 0011 End 0011
Frequency Setting	<ul style="list-style-type: none"> DRIVE mode is selected. Change reference value. Set value is written in. (Stops blinking for 3 seconds). Select output frequency monitor display. 	PRGM DRIVE RESET Δ ▽ DATA ENTER DSPL	F0000 F0150 F0150 (Stops blinking for 3 seconds.) 00

(Cont'd)

Operation	[Description]	[Key Operation]	[Digital Operator] Display
FWD run	<ul style="list-style-type: none"> Running operation. 	RUN LED lamp [RUN] lights.	150 60 Hz
Change frequency reference value	<ul style="list-style-type: none"> Select frequency reference value reference display. Change reference value. Write in set value (stops blinking for 3 seconds). Select output frequency monitor display. 	DSPL (Depress 3 times.) RESET Δ ▽ DATA ENTER DSPL FWD REV	F0150 F0600 F0600 600 60 Hz
REV run	<ul style="list-style-type: none"> Change to REV run. 	FWD REV LED lamp [REV] lights.	-600 60 Hz
Stop	<ul style="list-style-type: none"> Decelerating to stop 	STOP LED lamp [STOP] lights. ([RUN] blinks while decelerating.)	00 00

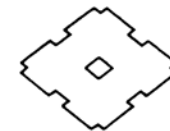

2.5 CONSTANT INITIALIZATION AND WRITE-IN PROHIBIT

2.5.1 Constant Initialization (Operation to return to factory setting)

- Write in 8 to constant (No.00).

[Description]	[Key Operation]	[Digital Operator Display]
• Select PRGM mode.		no-01
• Select constant (No.00).		no-00
• Constant (No.00) data is displayed.		01 *
• Change the set value.		08
• Write in the set value. (End is displayed for 1 second.) The data are displayed again after End is displayed.		End 01 †

* Differs according to the setting data before changing.

† The display returns to 01 after write-in. This indicates that initialization is executed at writing in the data.

2.5.2 Constant Write-in Prohibit (Only constant reading possible)

- The following shows an example where 0 is written in to constant (No.00) [password (No.00) setting/reading and the first functions (constant Nos. 01 to 19) reading enabled].

[Description]	[Key Operation]	[Digital Operator Display]
• Select PRGM mode.		no-01
• Select constant (No.00).		no-00
• Constant (No.00) data is displayed.		01 *
• Change the set value.		00
• Write in the set value. (End is displayed for 1 second.) The data are displayed again after End is displayed.		End 00

* Differs according to the setting data before changing.

For details, refer to "PASSWORD SETTING" on page 79.

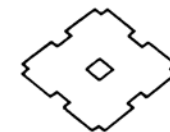

2.6 CORRECTIVE FUNCTION

2.6.1 Adjustment of Frequency Setting Value, Output Frequency Bias (No.23) and Gain (No.22)

Any desired value of output frequency for frequency set value (0 to 10V or 4 to 20mA) can be set.

<Example> Adjust so as to obtain 10% speed (6Hz) at frequency setting voltage 0V and 100% speed (60Hz) at 8V.
[Set constant (No.23)=0.10 and constant (No.22) = 1.23.]

[Description]	[Key Operation]	[Digital Operator Display]
• Select PRGM mode.		no-0!
<Bias> • Select constant (No.23).		no-23
• Data (No.23) are displayed.		0.00
• Change the set value.		0.10 (10%=0.1)
• Write in the set value. (End is displayed for 1 second.) The data are displayed again after End is displayed.		End 0.10

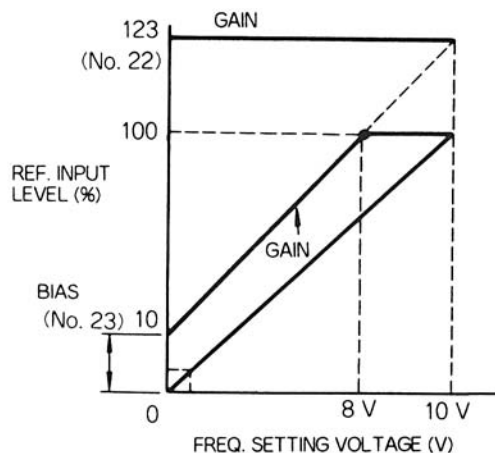

<Gain>	Key Operation	Display
• Select constant (No.22).		no-22
• Data (No.22) are displayed.		1.00
• Change the set value.		1.23 *
• Write in the set value. (End is displayed for 1 second.) The data are displayed again after End is displayed.		End 1.23

*How to calculate gain

$$x = \frac{100 - b}{a} \dots (1) \quad G = \frac{10x + b}{100} \dots (2)$$

x can be obtained by equation (1).

$$x = \frac{100 - 10}{8} = 11.25$$

Then by substituting x obtained in equation (1) for equation (2) to obtain G :

$$G = \frac{10 \times 11.25 + 10}{100} = 1.225 \\ = 1.23$$

- a : Setting voltage at 100% frequency (V)
In this example, since 100% speed (60Hz) is obtained at 8V, a = 8.
- b : Bias level (%)
In this example, since 10% speed (6Hz) is obtained at frequency setting voltage 0V, b = 10.
- G : Gain set value
In this example, it is 1.23.

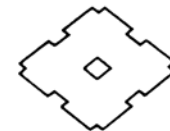

2.6.2 Calibration of Frequency Meter

Calibration of frequency meter or ammeter connected to the inverter can be performed even without providing a calibration resistor.

<Example> When the frequency meter specifications are 3V (1mA) full-scale, 3V full-scale output is used at maximum output frequency [constant (No.02)] operation.
 [Set constant (No.45) = 0.30.]

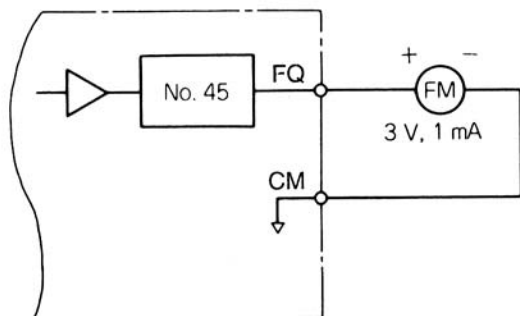

Frequency Meter Calibration

[Description]	[Key Operation]	[Digital Operator Display]
• Select PRGM mode.		no-01
• Select constant (No.45).		no-45
• Data are displayed.		!00
• Change the set value.		0.30 10 V × 0.3 = 3.0 V*
• Write in the set value. (End is displayed for 1 second.) The data are displayed again after End is displayed.		End 0.30

* Since analog monitor gain is set to 1.00 prior shipping, 10V is output at maximum output frequency [constant (No.02)] operation.

Note : By data display of constant (No.45) in the program mode, voltage at 100% level according to the constant (No.45) set value is output by the meter calibrating function without any conditions.

(Example) Assuming constant (No.45) = 0.30 : $10V \times 0.30 = 3V$ is output without any conditions.

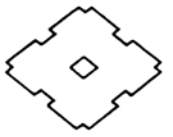

2.7 MONITOR

Frequency reference value, output frequency, output current and fault contents can be monitored.

2.7.1 Typical Monitor Contents and Display (DRIVE Mode)

The monitor item is changed every time the  key is depressed.

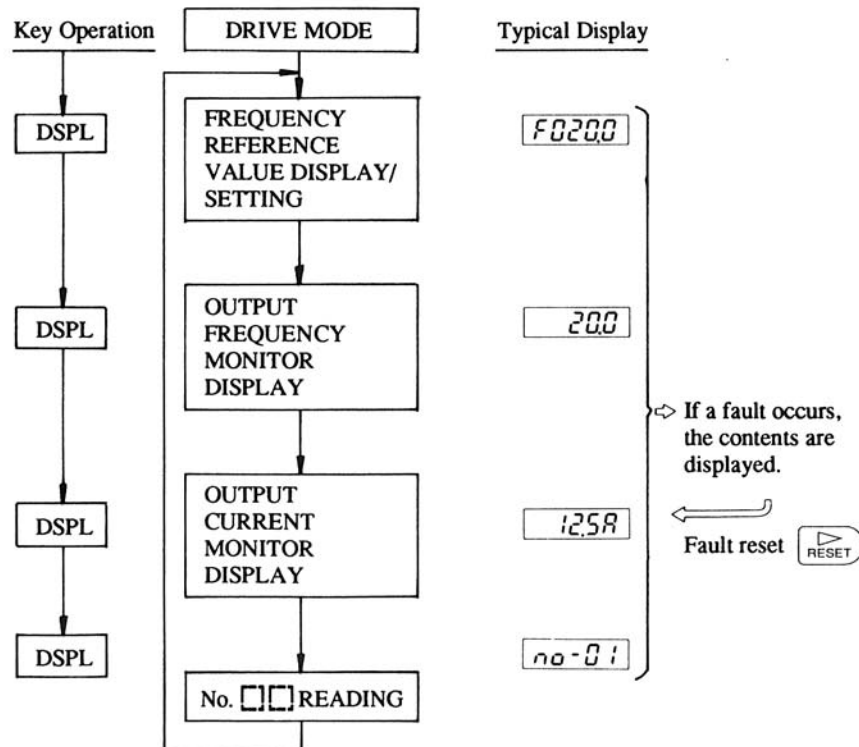

2.7.2 Monitoring of Fault Contents

· If a fault occurs, the fault contents are displayed with priority over other display items.

Depress the  key or turn on the fault reset input signal to reset the fault.

· Since the latest fault content data are stored in the inverter, even if the power supply is turned off, they can be monitored after the power supply is turned on again.

(1) Checking fault contents

The latest data are stored in the constant (No.48). (except UV)

(2) Clearing fault contents

The contents are cleared by setting "6" to the constant (No.00).

Or they are also cleared by constant initialization. [Set constant (No.00)=8 or 9.]

At this time, other constants are changed to the factory setting values. Therefore, record all of the constant data before initializing constant.

(3) Faults to be stored

OC (overcurrent), OV (overvoltage), OH (cooling fin overheat), OL1 (motor overload), OL2 (inverter overload), OL3 (overtorque detection), EF4, EF5 (external fault), CPF05 (AD converter fault).

For details, refer to Table 1.8 "Fault Display and Contents" on page 35.

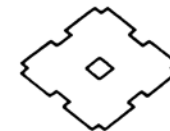

FUNCTIONS & CONSTANTS

2.8 FUNCTION/CONSTANT LIST

2.8.1 First Functions (Constant Nos. 00 to 19)

Function	No.	Name	Description	Initial Setting	User Set Values	Reference Page
Constant Group Selection	00	Password	0 : Password (No. 00) setting/reading and first function (constant Nos. 01 to 19) reading possible	1		79
Fault Contents Clear			1 : First function (constant Nos. 00 to 19) setting/reading possible			
Constant Initialization			2 : First and second functions (constant Nos. 00 to 29) setting/reading possible 3 : First, second and third functions (constant Nos. 00 to 59) setting/reading possible 6 : Fault record clear 8 : Initialize factory reset 9 : Initialize factory reset 3-wire control 10 : Factory reset – UL unit 11 : Factory reset 3-wire control – UL unit			
Constant Method Selection	01*	Run Signal Selection 1	1st digit = 0: Master frequency reference – Control circuit terminals VF and CM; or IF and CM inputs = 1 : Master frequency reference – Operator FXXXX	0011† (0000)		80
Stopping Method Selection			2nd digit = 0 : Run by control circuit terminal run command = 1 : Run by operator run command			
V/f Pattern Setting			3rd digit = 0 : Deceleration to a stop = 1 : Coasting to a stop			
		Output Voltage Limiter Selection	4th digit = 0 : Free choice V/f with output voltage limiter = 1 : Free choice V/f without output voltage limiter			

* The first to fourth digits indicated in the description of constant (No. 01) mean the following digits. This also applies to the other constants.

† The value in parentheses is factory set value of models without digital operator (with indicating cover).

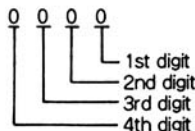

Function	No.	Name	Description	Initial Setting	User Set Values	Reference Page
V/f Pattern Setting	02	Maximum Output Frequency	Setting unit : 0.1 Hz, Setting range : 50.0 to 400.0 Hz	60.0 Hz		84
	03	Maximum Voltage	Setting unit : 0.1 V, Setting range : 0.1 to 255.0 V	230V*		
	04	Maximum Voltage Output Frequency (Base Frequency)	Setting unit : 0.1 Hz, Setting range : 0.2 to 400.0 Hz	60.0 Hz		
	05	Intermediate Output Frequency	Setting unit : 0.1 Hz, Setting range : 0.1 to 399.9 Hz	1.5 Hz		
	06	Intermediate Output Frequency Voltage	Setting unit : 0.1 V, Setting range : 0.1 to 255.0 V	11.0 V		
	07	Minimum Output Frequency	Setting unit : 0.1 Hz, Setting range : 0.1 to 10 Hz	1.5 Hz		
	08	Minimum Output Frequency Voltage	Setting unit : 0.1 V, Setting range : 0.1 to 50 V	11.0 V		
	First Accel/ Decel Time Setting	09	Acceleration Time 1	Setting unit : 0.1 s, Setting range : 0.0 to 600.0 s	5.0s	
10		Deceleration Time 1	Setting unit : 0.1 s, Setting range : 0.0 to 600.0 s	5.0s		
Second Accel/ Decel Time Setting	11	Acceleration Time 2	Setting unit : 0.1 s, Setting range : 0.0 to 600.0 s	10.0 s		
	12	Deceleration Time 2	Setting unit : 0.1 s, Setting range : 0.0 to 600.0 s	10.0 s		

* For 460 V class, the value is twice as that of 230 V class..

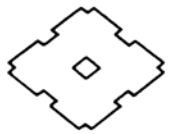

Function	No.	Name	Description	Initial Setting	User Set Values	Reference Page
Frequency Reference*	13	Frequency Reference 1	Setting unit : 0.1 Hz, Setting range : 0.0 to 400.0 Hz	10.0 Hz		82
	14	Frequency Reference 2	Setting unit : 0.1 Hz, Setting range : 0.0 to 400.0 Hz	20.0 Hz		
	15	Frequency Reference 3	Setting unit : 0.1 Hz, Setting range : 0.0 to 400.0 Hz	30.0 Hz		
	16	Frequency Reference 4	Setting unit : 0.1 Hz, Setting range : 0.0 to 400.0 Hz	40.0 Hz		
	17	Jog Frequency Reference	Setting unit : 0.1 Hz, Setting range : 0.0 to 400.0 Hz	6.0 Hz		
Electronic Thermal Overload Motor Protection	18	Motor Protection Selection	1st digit = 0: Electronic thermal overload motor protection provided = 1: Electronic thermal overload motor protection not provided 2nd digit = 0: Electronic thermal overload characteristics is for standard motor = 1: Electronic thermal overload characteristics is for constant torque motor 3rd digit = 0: Electronic thermal overload time constant is of standard rating = 1: Electronic thermal overload time constant is of short term rating 4th digit : Not used	0000		88
Electronic Thermal Overload Reference Current	19	Motor Rated Current	Setting unit : 0.1 A, Setting range : 10 to 120% of inverter rated current	†		

* Can be changed even during run.

The maximum setting frequency to be set to frequency reference is the maximum frequency (No. 02).

† Initial setting differs according to the inverter capacity.

2.8.2 Second Functions (Constant Nos. 20 to 29)

Function	No.	Name	Description	Initial Setting	User Set Values	Reference Page															
REV Run Prohibit	20	Run Signal Selection 2	1st digit = 0: REV run enabled = 1: REV run disabled	0000		80															
Operator Stop Key Precedence			2nd digit = 0: STOP key effective from control circuit terminals during run = 1: STOP key ineffective from control circuit terminals during run			—															
			3rd digit : Not used.																		
Stall Prevention During Deceleration			4th digit = 0: Stall prevention during deceleration provided = 1: Stall prevention during deceleration not provided (when braking resistor connected)			92															
Analog Monitor Selection	21	Output Monitor Selection	1st digit : Not used. 2nd digit = 0: Analog monitor - output frequency = 1: Analog monitor - output current (Analog monitor gain is set by constant No. 45.)	0000		90															
			S-curve Accel/decel Selection			3rd, 4th digit	83														
			<table border="1"> <thead> <tr> <th>S-curve Accel/decel Selection</th> <th>Not Provided</th> <th>0.2 sec</th> <th>0.5 sec</th> <th>1.0 sec</th> </tr> </thead> <tbody> <tr> <td>3rd Digit</td> <td>0</td> <td>1</td> <td>0</td> <td>1</td> </tr> <tr> <td>4th Digit</td> <td>0</td> <td>0</td> <td>1</td> <td>1</td> </tr> </tbody> </table>	S-curve Accel/decel Selection	Not Provided	0.2 sec	0.5 sec	1.0 sec	3rd Digit	0	1	0	1	4th Digit	0	0	1	1			
S-curve Accel/decel Selection	Not Provided	0.2 sec	0.5 sec	1.0 sec																	
3rd Digit	0	1	0	1																	
4th Digit	0	0	1	1																	

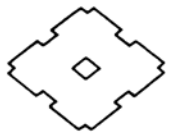

Function	No.	Name	Description	Initial Setting	User Set Values	Reference Page
	22	Frequency Reference Gain	Setting unit : 0.01, Setting range : 0.01 to 2.00	1.00		88
	23	Frequency Reference Bias	Setting unit : 0.01, Setting range : -1.00 to 1.00	0.00		88
Frequency Limit Control	24	Frequency Upper Limit	Setting unit : 1%, Setting range : 0 to 110%	100%		91
	25	Frequency Lower Limit	Setting unit : 1%, Setting range : 0 to 110%	0%		
DC Injection Braking	26	DC Injection Braking Current	Setting unit : 1%, Setting range : 0 to 100% of inverter rated current	50%		99
	27	DC Injection Braking Time at Stop	Setting unit : 0.1 s, Setting range : 0.0 to 5.0 s	0.5 s		
	28	DC Injection Braking Time at Start	Setting unit : 0.1 s, Setting range : 0.0 to 5.0 s	0.0 s		
Torque Compensation	29	Automatic Torque Boost Gain	Setting unit : 0.1, Setting range : 0.0 to 3.0	1.0		94

2.8.3 Third Functions (Constant Nos. 30 to 59)

Function	No.	Name	Description	Initial Setting	User Set Values	Reference Page	
Stall Prevention	30	Stall Prevention Level during Acceleration	Setting unit : 1% Setting range : 30 to 200% of inverter rated current Note : Stall prevention during acceleration does not operate at 200%.	170%		92	
	31	Stall Prevention Level during Run	Setting unit : 1% Setting range : 30 to 200% of inverter rated current Note : Stall prevention during run does not operate at 200%.	160%			
Multifunction Selection	Contact Input Signal	32	Multifunction Input Selection 1 (Terminal ES Function Section)	0 : FWD/REV run command (3-wire sequence selection) 1 : External fault (NO contact input) 2 : External fault (NC contact input) 3 : Multi-step speed reference 1 4 : Multi-step speed reference 2 5 : JOG command 6 : Accel/decel time select 7 : External baseblock (NO contact input) 8 : External baseblock (NC contact input) 9 : Search command from maximum frequency 10 : Search command from setting frequency 11 : Accel/decel prohibit	1		94
		33	Multifunction Input Selection 2 (Terminal DF Function Selection)	1 : External fault (NO contact input) 2 : External fault (NC contact input) 3 : Multi-step speed reference 1 4 : Multi-step speed reference 2 5 : JOG command 6 : Accel/decel time select 7 : External baseblock (NO contact input) 8 : External baseblock (NC contact input) 9 : Search command from maximum frequency 10 : Search command from setting frequency 11 : Accel/decel prohibit	3		94

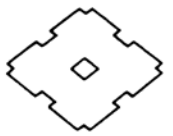

Function	No.	Name	Description	Initial Setting	User Set Values	Reference Page
Multifunction Selection Photo-coupler Output Signal	34	Multifunction Output Selection 1 (Terminal DV Function Selection)	0: Running 1: Frequency agreement 2: Zero speed 3: Frequency detection (output frequency \geq frequency detection level) 4: Overtorque detection	0		98
	35	Multifunction Output Selection 2 (Terminal UF Function Selection)	0: Running 1: Frequency agreement 2: Zero speed 3: Frequency detection (output frequency \geq frequency detection level) 4: Overtorque detection	1		
Desired Speed Detection	36	Frequency Detection Level	Setting unit : 0.1 Hz, Setting range : 0.0 to 400.0 Hz	0.0 Hz		103
Over-torque Detection	37	Overtorque Detection Function Selection	1st digit = 0: Overtorque detection not provided = 1: Overtorque detection provided	0000		101
			2nd digit = 0: Detected only frequency agreement = 1: Detected during running			
			3rd digit = 0: Operation continues after overtorque detection = 1: Output shut-off at overtorque detection			
			4th digit : Not used			
	38	Overtorque Detection Level	Setting unit : 1%, Setting range : 30 to 200% of inverter rated current	160%		
	39	Overtorque Detection Level	Setting unit : 0.1 s, Setting range : 0.1 to 10.0 s	0.1 s		

Function	No.	Name	Description	Initial Setting	User Set Values	Reference Page
Carrier Frequency Adjustment	40	Carrier Frequency	Setting unit : 1 (2.5 kHz) Setting range : 1 to 6 (2.5 to 15 kHz)	4 (10 kHz)		102
	— 41 to 44	Not used	(Setting disabled.)	—		—
Analog Monitor Scale Calibration	45	Analog Monitor Gain	Setting unit : 0.01, Setting range : 0.01 to 2.00	1.00		100
Momentary Power Loss Protection	46	Operation Selection after Momentary Power Loss	1st digit = 0: Continuous operation after momentary power loss not provided = 1: Continuous operation after momentary power loss provided 2nd, 3rd, 4th digits = Not used.	0000		109
Fault Retry	47	Fault Retry Selection	Setting unit : 1 time, Setting range : 0 to 10 times Note : By setting 0 times, fault retry function becomes disabled.	0		112
Fault Trace	48	Fault Record	The latest fault is displayed (setting disabled).	—	—	—
Software Version	49	PROM No.	PROM No. is displayed (setting disabled).	—	—	—

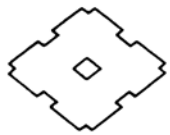

Function	No.	Name	Description	Initial Setting	User Set Values	Reference Page
Prohibited Frequency	50	Prohibited Frequency 1	Setting unit : 0.1 Hz, Setting range : 0.0 to 400.0 Hz	0.0 Hz		105
	51	Prohibited Frequency 2	Setting unit : 0.1 Hz, Setting range : 0.0 to 400.0 Hz	0.0 Hz		
	52	Prohibited Frequency 3	Setting unit : 0.1 Hz, Setting range : 0.0 to 400.0 Hz	0.0 Hz		
	53	Prohibited Width	Setting unit : 0.1 Hz, Setting range : 0.0 to 25.5 Hz	1.0 Hz		
Speed Search Control	54	Speed Search Motion Level	Setting unit : 1%, Setting range : 0 to 200% of inverter rated current	150%		107
	55	Minimum Baseblock Time	Setting unit : 0.1 s, Setting range : 0.5 to 5.0 s	0.5 s		
	56	V/f during Speed Search	Setting unit : 1%, Setting range : 0 to 100%	100%		
Relay Contact Output Signal	57	Multifunder Relay Output (Terminal FA, FB, FC)	0 : Running 1 : Frequency Agreement 2 : Zero Speed 3 : Output Frequency ≥ Frequency Detection Level 4 : Overtorque Detection 5 : Operation Mode 6 : Fault Output			
	58 to 59		Not Used			

2.9 DESCRIPTION OF FUNCTIONS AND CONSTANTS

Constant Nos. are indicated as **N**.

PASSWORD SETTING

Item Name	Constant to be Set	Factory Preset
Constant Group Selection	0	1

- **0** = 0
Password **0** setting/reading and the first function (**0** to **19**) reading are enabled.
This setting prevents constant from being reset by improper operation after completion of constant setting.
0 can be written in.
- **0** = 0 The first functions can be read.
- **0** = 1 The first functions (**0** to **19**) can be set and read.
- **0** = 2 The first and second functions (**0** to **29**) can be set and read.
- **0** = 3 The first, second and third functions (**0** to **59**) can be set and read.
- **0** = 6 Fault history is cleared.
- **0** = 8 All control constants can be initialized. Terminal functions are returned to the factory setting.
- **0** = 9 All control constants can be initialized. Terminal functions are of 3-wire sequence. Refer to "MULTIFUNCTION CONTACT INPUT FUNCTION SELECTION" on page 94.

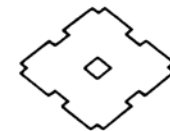

OPERATION MODE SELECTION

Item Name	Constant to be Set	Factory Preset
Start/Stop Procedure	1	0011 (0000)*
Reverse Rotation Prevention	20	0000

* The value in parentheses is factory setting of models with indicating cover.

• Start procedure

Operation can be performed from the operator or control circuit terminal input.

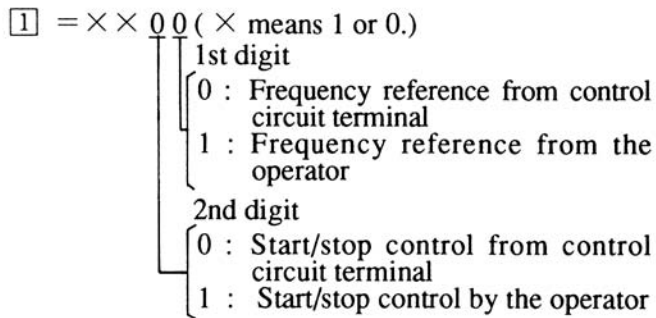

• Stop procedure

Stopping mode can be selected according to the application.

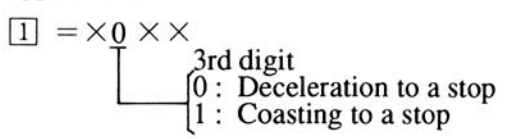

• Reverse rotation prevention

Prevents accidental selection of reverse rotation. REV run command is disregarded if input.

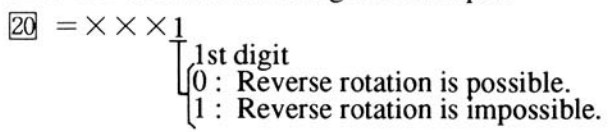

Note : The first to fourth digits indicated in the description of the constant mean the following digits.

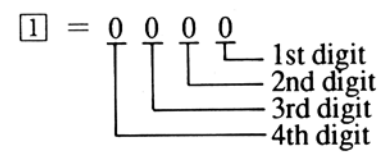

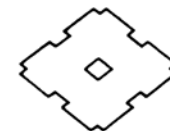

4-STEP SPEED CHANGE

Item Name	Constant to be Set	Factory Preset
Multi-speed Frequency Reference	13 to 16	See page 72.
Multi-speed Operation Function	32, 33	See page 75.

Up to 4 steps of speed can be set by contact input by setting multi-speed references to multifunction contact input terminals.

This eliminates the need for an analog signal thereby enabling operation even at low speed without being affected by noise. See the following example. (When setting 32 = ES, 33 = DF)

- Set according to run specifications.

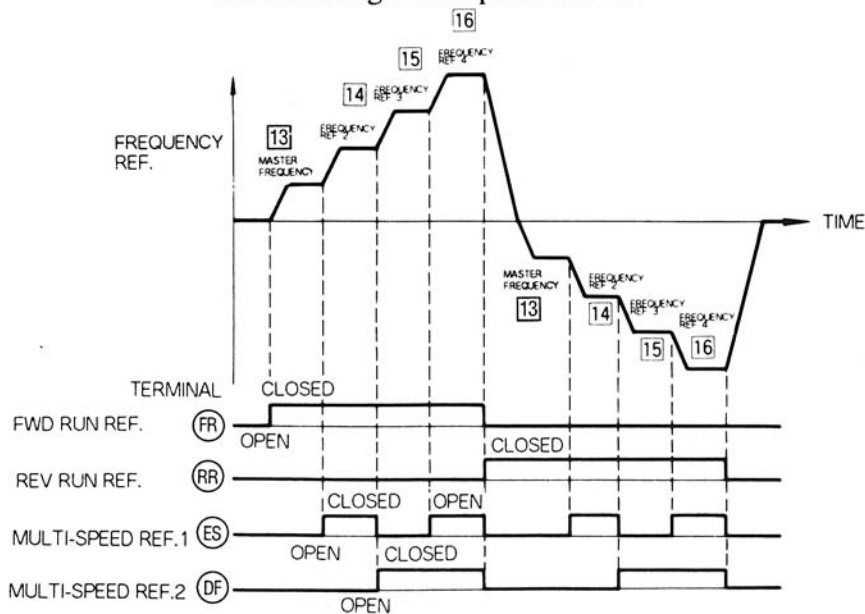

Note : Frequency reference can be changed only if it is selected by multi-speed reference.

S-CURVE PATTERN SELECTION

Item Name	Constant to be Set	Factory Preset
S-curve Pattern Selection	21	0000

To prevent shock at machine starting/stopping, accel/decel in S-curve pattern is enabled by the setting of 21.

$$21 = 00 \times \times$$

3rd, 4th digits

- 00 : S-curve section not provided (linear accel/decel)
- 01 : S-curve section 0.2 second
- 10 : S-curve section 0.5 second
- 11 : S-curve section 1 second

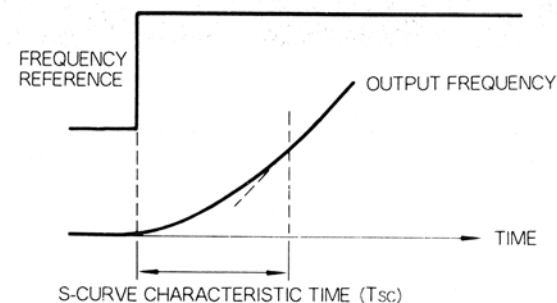

Note : S-curve characteristic time refers to the time from the acceleration rate 0 to regular acceleration rate determined by the set acceleration time.

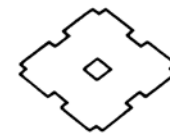

The following shows the time chart at FWD/REV run switching at deceleration to a stop.

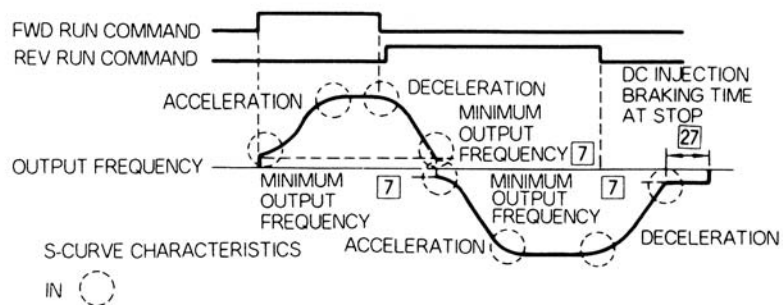

V/f CHARACTERISTIC SETTING

Item Name	Constant to be Set	Factory Preset
Max. Output Frequency	[2]	60.0 Hz
Max. Voltage	[3]	200.0 V
Max. Voltage Output Frequency	[4]	60.0Hz
Intermediate Output Frequency	[5]	1.5 Hz
Intermediate Output Frequency Voltage	[6]	11 V
Min. Output Frequency	[7]	1.5 Hz
Min. Output Frequency Voltage	[8]	11 V
Output Voltage Limiter Selection	[1]	0000

· V/f pattern setting

Any desired V/f pattern can be set for special specifications, too. Any V/f pattern can be set according to the load characteristics. The factory preset value is set to 60 Hz saturation type pattern.

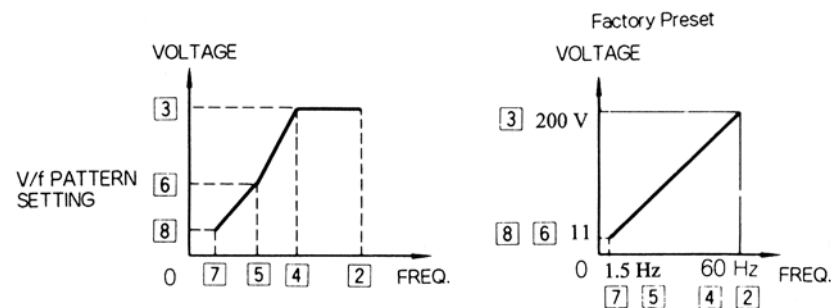

Note : If an excessively large value is set in low-speed area (3Hz or less), motor overheat or inverter malfunction may occur. Change the constant gradually monitoring load or motor current.

· Output limiter selection

When V/f is set to excessively large value, an inverter fault may occur. Therefore, in order to prevent malfunction, the upper limit is provided for the output voltage. However, the setting is not necessary under normal operation.

[1] = 0 × × ×
 4th digit
 0 : Desired V/f with output voltage limiter
 1 : Desired V/f without output voltage limiter

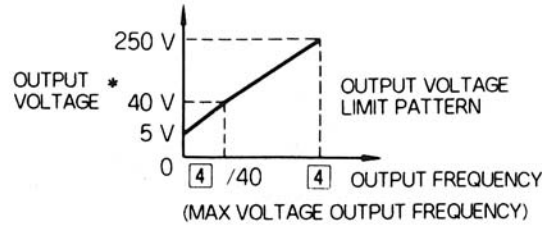
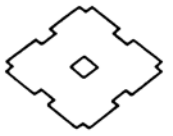

* For 460 V class, the value is twice that of 230 V class.

If "1" is set, V/f matching the motor characteristics must be selected.

JOG OPERATION

Item Name	Constant to be Set	Factory Preset
Jog Frequency Reference Setting	17	6.0 Hz
Jog Reference Selection	32, 33	See page 75.

To select the jog mode, close between terminals (ES) - (BC). Jog operation can then be performed by closing the FWD/REV run command (when setting 32 = 5).

Depressing the JOG key on the digital operator performs the same operation.

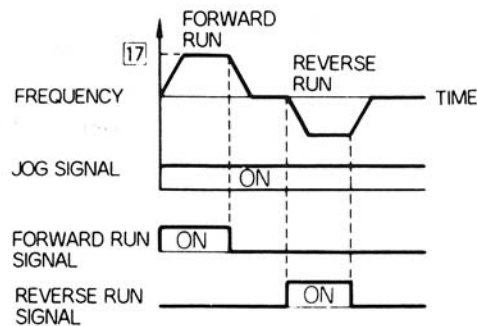

ACCEL/DECEL TIME SETTING

Item Name	Constant to be Set	Factory Preset
Acceleration Time 1	9	5.0
Deceleration Time 1	10	5.0
Acceleration Time 2	11	10.0 s
Deceleration Time 2	12	10.0 s
Accel/Decel Time Select	32, 33	See page 75.

• Each item can be set from 0.0 sec to 600 sec.

The set time indicates the interval required before the maximum output frequency setting 2 is reached. Accel/decel time can be set for two-step switching using multifunction contact input, even during running.

Between control circuit terminals (DF) - (BC)

- Open : 9 and 10 are selected.
- Closed : 11 and 12 are selected.
(when setting 33 = 2)

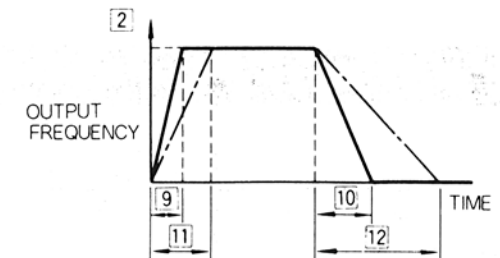

Note : S-curve accel/decel reducing shock at motor starting is also enabled. When S-curve accel/decel is needed, refer to "S-CURVE PATTERN SELECTION" on page 83.

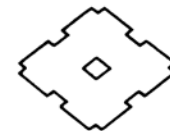

OUTPUT FREQUENCY CONTROL (GAIN/BIAS)

Item Name	Constant to be Set	Factory Preset
Frequency Reference Gain	22	1.00
Frequency Reference Bias	23	0.00

Output frequency (gain/bias) can be set freely according to frequency setting (0 to 10V or 4 to 20mA).

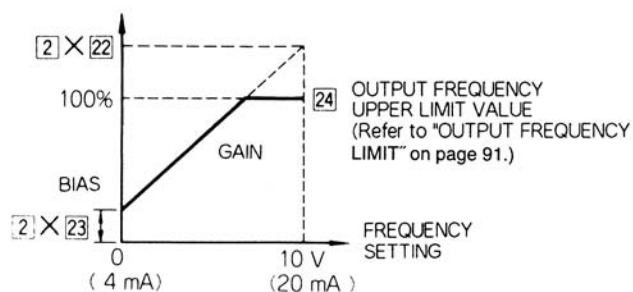

For the setting method, refer to Par.2.6.1 "Adjustment of Frequency Setting Value, Output Frequency Bias (No. 23) and Gain (No. 22)" on page 64.

ELECTRONIC THERMAL OVERLOAD PROTECTION

Item Name	Constant to be	Factory Preset
Motor Type	18	0000
Motor Rated Current	19	—

Motor output current is detected by the inverter built-in electronic thermal overload function, and inverter exclusive-use motors or standard motors are prevented from overloading. (It is not necessary to mount the thermal overload relay externally. However, to connect several motors to one inverter, a thermal overload relay must be inserted for each motor. It is necessary to reduce carrier frequency according to the wiring distance between the inverter and motor when thermal overload relays are inserted. For details, refer to the precautions on wiring described on page 18.)

19 = Motor rated current value

Set the motor rated current value according to the value on the motor nameplate.

18 = × × 0 ×
 2nd digit
 0 : Standard motor
 1 : Inverter duty motor

18 = × × × 1 can make electronic thermal overload function disabled.
 1st digit
 0 : Electronic thermal overload protection provided
 1 : Electronic thermal overload protection not provided

18 = × 0 × ×
 3rd digit
 0 : Electronic thermal overload time constant is used for standard motors or inverter duty motor (standard ratings)
 1 : Electronic thermal overload time constant is used for motors other than described above (short-term ratings)

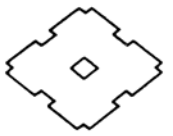

MULTIFUNCTION ANALOG OUTPUT MONITOR SETTING

Item Name	Constant to be Set	Factory Preset
Output Monitor Select	[21]	0000
Analog Monitor Gain	[45]	1.00

Either output frequency or output current can be monitored by analog output between control circuit terminals (FO) and (CM). (0 to 10V output)

[21] = × × 0 ×
 Not used
 Output contents between control circuit terminals (ES) - (BC)
 2nd digit
 { 0 : Output frequency monitor
 1 : Output current monitor

Analog output monitor gain can be set by [45].

Additionally, analog output monitor voltage is output as shown below :

Output frequency monitor :

Output voltage (V)

$$= \text{Output frequency} \times \frac{10 \text{ V}}{\text{Max. output frequency [2]}} \times [45]$$

Output current monitor :

Output voltage (V)

$$= \text{Output current} \times \frac{10 \text{ V}}{\text{Inverter rated current}} \times [45]$$

Note : Since output current becomes approx. 200% maximum of the inverter rated current, output voltage is clamped at approx. 11V when [45] is used at 1.00 and the inverter rated current is exceeded. To keep linearity, set [45] to approx. 0.5.

OUTPUT FREQUENCY LIMIT

Item Name	Constant to be Set	Factory Preset
Output Frequency (Speed) Upper Limit	[24]	100%
Output Frequency (Speed) Lower Limit	[25]	0

The upper and lower limits for the output frequency can be set. When the lower limit is not 0, acceleration to that lower limit setpoint begins until frequency reference reaches the lower limit value when the start command is input.

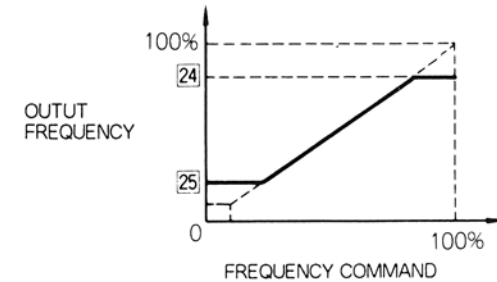

Note : By setting [24] to 110%, frequency up to [2] × 1.1 can be output.

(Example) Assuming [2] = 60Hz, [24] = 1.1, up to 66 Hz can be output. However, when the voltage exceeds 400 Hz, it is clamped at 400 Hz.

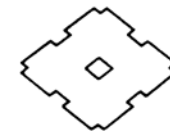

MOTOR STALL PREVENTION FUNCTION

Item Name	Constant to be Set	Factory Preset
Operation Level for Stall Prevention during Acceleration	[30]	170%
Operation Level for Stall Prevention during Running	[31]	160%
Stall Prevention Function during Deceleration	[20]	0000

Automatically adjusts output frequency according to the load so as to continue operation of the machine without stalling the motor.

- Stall prevention during acceleration

If the motor current exceeds the value set to [30] during acceleration, acceleration is stopped until the motor current is reduced to the [30] set value or less.

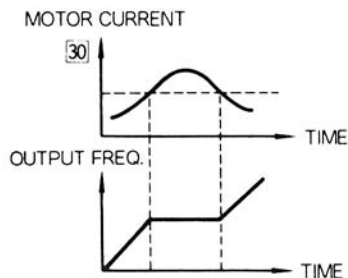

- Stall prevention during running

If the motor current exceeds the value set to [31] because of impact load during running, output frequency is automatically lowered. When the motor current is reduced to the [31] set value or less, the motor starts acceleration again and the operation is continued.

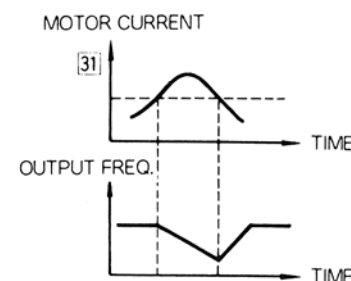

- Stall prevention during deceleration

Automatically adjusts deceleration rate with monitoring DC voltage to prevent overvoltage during deceleration. Set "1" for connecting braking resistor.

[20] = 0 × × ×

4th digit
 0 : Stall prevention during deceleration enabled
 1 : Stall prevention during deceleration disabled

- When the motor load is large or accel/decel time is short, the accel/decel time may be longer than the set value because of the stall preventive function.

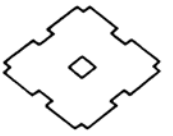

FULL-RANGE AUTOMATIC TORQUE BOOST

Item Name	Constant to be Set	Factory Preset
Torque Compensation Gain	29	1.0

Automatic control of V/f ratio according to the load torque ensures tripless operation and optimum output current. Therefore, tripless operation with excellent energy-saving effect is available. When the wiring distance between the inverter and motor is long (normally approx. 100 m) and when the motor torque is a little short, increase torque compensation gain gradually, checking the motor current. Normally, no adjustment is necessary.

MULTIFUNCTION CONTACT INPUT FUNCTION SELECTION

Item Name	Constant to be Set	Factory Preset
Multifunction Contact Input Function	32, 33	Refer to page 75.

The function of control circuit terminals ES and DF can be changed if necessary. Set $\text{32} < \text{33}$.
 Terminal ES function : Set to 32 .
 Terminal DF function : Set to 33 .

32 Set Value and its Functions

Set Value	Function	Page
0*	FWD/REV run command (3-wire sequence selection)	—
1	External fault (NO contact input)	118
2	External fault (NC contact input)	118
3	Multi-step speed reference 1	82
4	Multi-step speed reference 2	82
5	JOG command	86
6	Accel/decel time select	87
7	External baseblock (NO contact input)	122
8	External baseblock (NC contact input)	122
9	Search command from maximum frequency	107
10	Search command from setting frequency	107
11	Accel/decel hold command	114

Terminal function at 3-wire sequence selection.

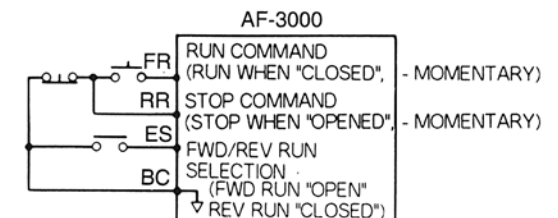

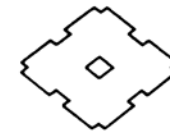

33 Set Value and its Functions

Set Value	Function	Page
1	External fault (NO contact input)	118
2	External fault (NC contact input)	118
3	Multi-step speed reference 1	82
4	Multi-step speed reference 2	82
5	JOG command	86
6	Accel/decel time select	87
7	External baseblock (NO contact input)	122
8	External baseblock (NC contact input)	122
9	Search command from maximum frequency	107
10	Search command from setting frequency	107
11	Accel/decel prohibit command	114

- Contact input capacity is 24 VDC 8 mA or less.
- Circuit leakage current at signal OFF must be 100 μ A or less.

Wiring Example (Open-collector Input)

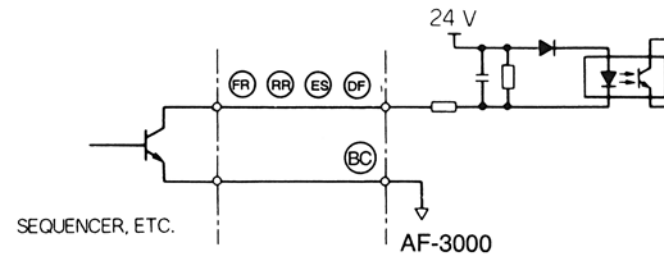

- The control signal line should not be longer than 50 m.
- To drive the contact input by transistor, use one rated for 50 V, 50 mA or more.
- Circuit leakage current at the signal OFF must be 300 μ A or less.

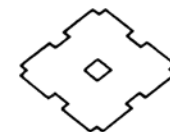

MULTIFUNCTION PHOTO-COUPLER OUTPUT FUNCTION

Item Name	Constant to be Set	Factory Preset
Multifunction Contact Output Function	[34], [35]	See page 76.

Functions of control circuit terminals (DV) - (OM) and (UF) - (OM) can be switched.

Function of terminal between (DV) - (OM) at "L" : Set into [34]

Function of terminal between (UF) - (OM) at "L" : Set into [35]

Set Value	Function
0*	In operation
1†	Frequency agreed
2	Zero speed
3	Frequency detection (output frequency \geq frequency detection level)
4	Overtorque detected

* Factory preset value of [34]

† Factory preset value of [35]

- Maximum output capacity is 48 VDC 50mA.
- To drive an inductive load, be sure to insert a free-wheel diode to control surge voltage.

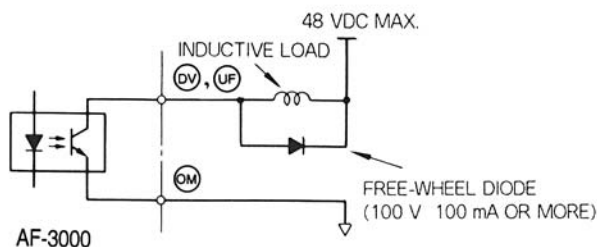

DC INJECTION BRAKING

Item Name	Constant to be Set	Factory Preset
DC Injection Braking during Stop	[27]	0.5 s
DC Injection Braking at Start	[28]	0.0 s
DC Injection Braking Current	[26]	50%

- DC injection braking at stop

Prevents overrun at stop. If output frequency becomes minimum output frequency [7] or less, DC injection brake is applied for the time set by [27] and the motor is stopped. By setting 0.0 s to [27], DC injection braking becomes disabled: the motor coasts to a stop when the output frequency is less than the minimum output frequency [7].

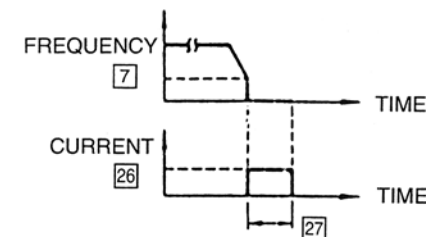

- DC injection braking at start. Starts a coasting motor without tripping even when the direction of rotation is unknown.

When the run command is input, DC injection brake is applied for the time set by [28], and the motor stops. Then the motor starts operation.

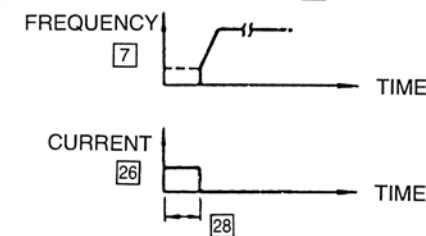

- DC braking current
DC injection braking current 100% equals the inverter rated current. It is set to 50% at factory prior to shipping.

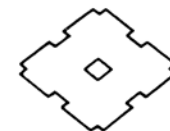

FREQUENCY/CURRENT METER CALIBRATION

Item Name	Constant to be Set	Factory Preset
Analog Monitor Gain	[45]	1.00
Output Monitor Selection	[21]	0000

Frequency/current meter connected to the inverter can be calibrated by [45] without using a resistor for calibration. For the setting method, refer to Par. 2.6.2 "Calibration of Frequency Meter" on page 66 and "MULTIFUNCTION ANALOG OUTPUT MONITOR SETTING" on page 90.

Selection of output between control circuit terminals (FQ) - (CM)

[21] = × × 0 ×
 2nd digit
 { 0 : Output frequency
 { 1 : Output current

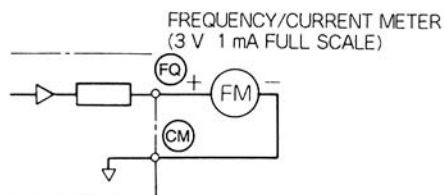

OVERTORQUE DETECTION FUNCTION

Item Name	Constant to be Set	Factory Preset
Overtorque Detection Level	[38]	160%
Overtorque Detection Time	[39]	0.1 s
Overtorque Detection Signal	[34], [35]	See page 76.
Overtorque Detection Selection	[37]	0000

When excess load is placed on the machine, the increase in motor current is detected. If current exceeding the value set by [38] lasts for a time exceeding the value set by [39], the overtorque detection signal is output to control circuit terminal (DV) or (UF) until the current is reduced to the [38] set value or less. To output the signal to control circuit terminal (DV), set [34] to 4, and to (UF), [35] to 4.

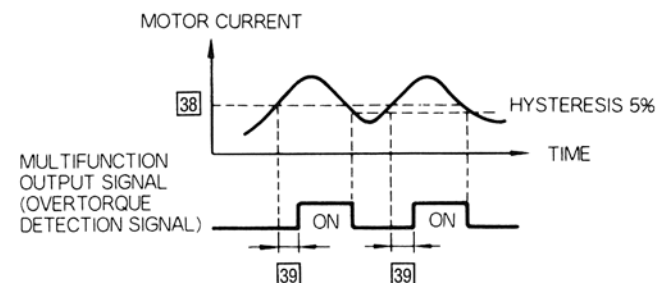

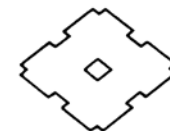

The **[37]** setting can select overtorque detection only during agreed speed or during running. Additionally, it can select continuous operation or output shut-off at overtorque detection.

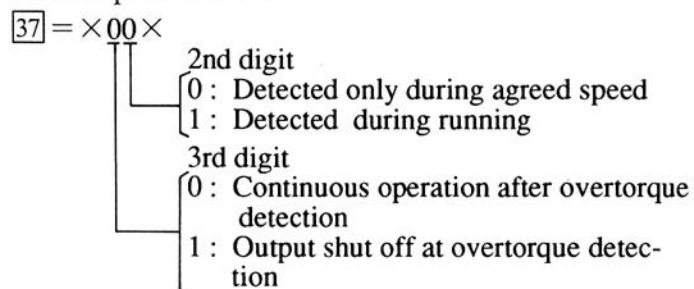

CARRIER FREQUENCY

Item Name	Constant to be Set	Factory Preset
Carrier Frequency	[40]	4

Changing the carrier frequency reduces RFI noise and leakage current without increasing motor noise.

Carrier frequency (kHz) = 2.5 kHz × **[40]** set value

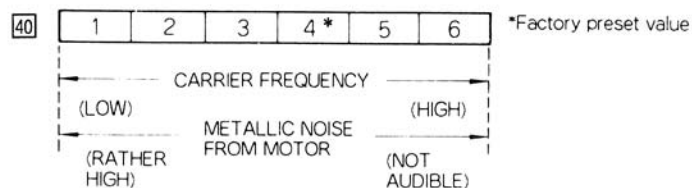

Note : Reduce continuous output current for changing the frequency to 5 or 6.

Carrier Frequency Set Value	Maximum Continuous Output Current
1 to 4	Up to 100% of inverter output current
5	Up to 90% of inverter output current
6	Up to 80% of inverter output current

If wiring distance between inverter and motor is long, reduce the carrier frequency. For details, refer to wiring precautions on page 17.

ARBITRARY SPEED DETECTION LEVEL ADJUSTMENT AND SELECTION

Item Name	Constant to be Set	Factory Preset
Frequency Detection Level	[36]	0.0 Hz
Multifunction Contact Output Function	[34], [35]	See page 76.

This function is used when operation at an arbitrary speed must be indicated. By setting either set value to multifunction contact output function (**[34]**, **[35]**), the following signal output to control circuit terminal **(DV)** or **(UF)** is enabled. Set 1 or 3 to **[34]** or **[35]** when the signal is to be output to control circuit terminals **(DV)** and **(UF)**, respectively.

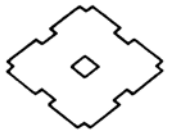

(1) Set value
= 1 : frequency agreed

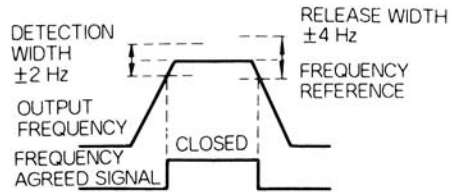

(2) Set value
= 3 : output frequency
≧ frequency detection level

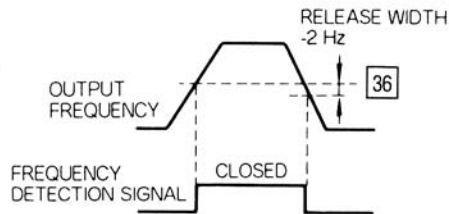

However, when "frequency agreed" is selected, the frequency agreed signal is turned OFF immediately at stop signal input.

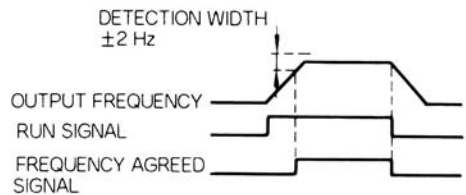

PROHIBITED FREQUENCY SETTING

Item Name	Constant to be Set	Factory Preset
Prohibited Frequency 1	[50]	0.0 Hz
Prohibited Frequency 2	[51]	0.0 Hz
Prohibited Frequency 3	[52]	0.0 Hz
Prohibited Width	[53]	1.0 Hz

To operate the inverter without resonance caused by machine system characteristic frequency, resonance generating frequency can be prohibited. This function can be also for dead band control.

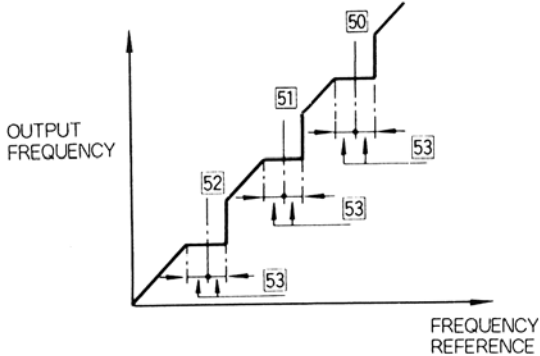

Constant-speed operation is prohibited within the prohibited range. However, output frequency is not prohibited during acceleration or deceleration for smooth acceleration or deceleration.

- (1) Prohibited frequency 1 to 3 ([50] to [52])
By setting the value to 0.0Hz, this function becomes disabled.
Set prohibited frequency 1 to 3 as described below :
Prohibited frequency 3 [52] ≤ Prohibited frequency 2 [51]
≤ Prohibited frequency 1 [50]
- (2) Prohibited width ([53])
By setting the value to 0.0Hz, this function becomes disabled.
The range to be prohibited is : [50] to [52] - [50] to [53] < prohibited range < [50] to [52] + [50] to [53]
(Example) When prohibited frequency 1 [50] is 45Hz and the prohibited width [53] is 2.0Hz : Prohibited range = 43 to 47Hz.

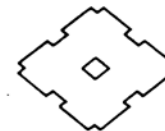

CONSTANTS EFFECTIVE FOR REDUCTION OF MACHINE VIBRATION OR SHOCK

The following constants are effective for reduction of vibration or shock.

Effective Method	Constant to be Set	Factory Preset	Adjustment	Page
Shock				
<ul style="list-style-type: none"> · To decrease generating torque · To increase generating torque 	[2] to [8]	See page 71.	Decrease or increase V/f.	71
	[29]	1.0	Decrease or increase torque boost.	94
To reduce shock at acceleration	[21]	0000	Set S-curve accel/decel.	83
	[9], [11]	10.0 s	Increase accel time.	87
	[30]	170%	Increase stall prevention level during accel.	92
To reduce shock at deceleration	[1]	0000	Set coasting to a stop.	80
	[21]	0000	Set S-curve accel/decel.	83
	[10], [12]	10.0 s	Increase decel time.	87
	[7]	1.5 Hz	Decrease or increase minimum output frequency.	84
	[26]	50%	Decrease DC injection braking current.	99
Vibration				
To decrease carrier frequency	[40]	4	—	102

SPEED SEARCH FUNCTION

Item Name	Constant to be Set	Factory Preset
Speed Search Function	[32], [33]	See page 75.
Speed Search Operation Level	[54]	150%
Minimum Baseblock Time	[55]	0.5 s

When the motor during coasting is started during changing operation of commercial power supply and inverter, etc., the motor can be operated without tripping by using the speed search function.

The speed search command is input from multifunction contact input terminals (ES) and (DF). For the functions of terminals (ES) and (DF), "6" or "7" is set to [32] or [33].

When setting to "6" : Search from maximum frequency
 When setting to "7": Search from setting frequency

By closing the search command during baseblock and inputting the run command, speed search is started after the inverter output is shut off for the minimum baseblock time [55].

When the inverter output current is larger than the set value of the speed search operation level [54], the speed search operation starts. Frequency in which the inverter output current becomes smaller than the speed search operation level [54] is judged to be the speed synchronized point, and the motor starts reacceleration/redeceleration up/down to the setting frequency in the set accel/decel time.

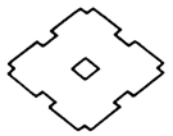

The following shows the time chart where the speed search command is input.

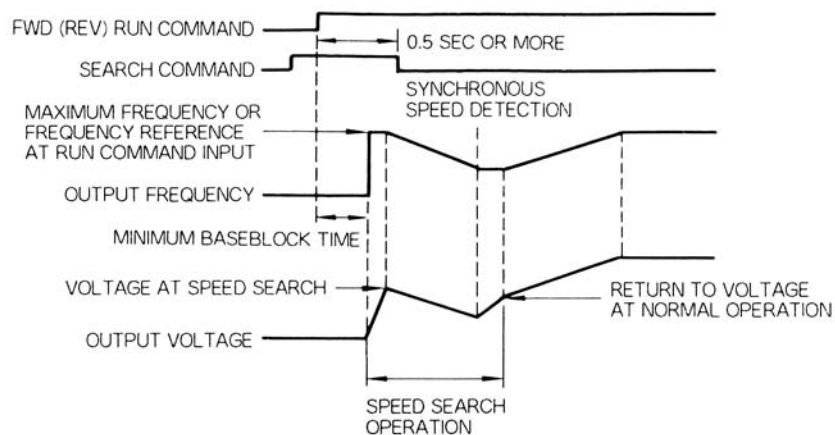

Notes :

1. When the search commands are input from maximum frequency and setting frequency simultaneously, the search command of lower terminal No. has the priority.
2. Make such sequence that FWD (REV) run command is to be input at the same time or after the search command.

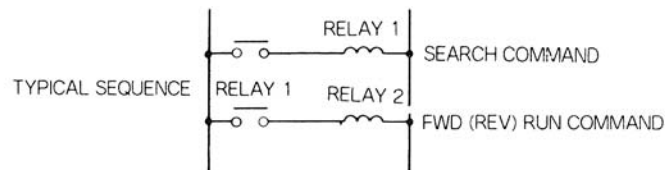

3. The minimum baseblock time is a time when the inverter output is shut off during the motor remaining voltage occurrence. Setting this time shorter can reduce the time until speed search start, but an inverter protective function such as overcurrent (OC) may operate because of the motor remaining voltage and the like. Therefore, do not reduce the time unnecessarily.

CONTINUOUS OPERATION AT MOMENTARY POWER LOSS

Item Name	Constant to be Set	Factory Preset
Operation Selection after Momentary Power Loss	46	0000
Speed Search Operation Level	54	150%
Minimum Baseblock Time	55	0.5 s

Even if a momentary power loss occurs, operation can be continued without any problem.

46 = × × × 0

1st digit

0 : Continuous operation after momentary power loss not provided

1 : Continuous operation after momentary power loss provided

Momentary power loss ride-thru time differs as shown below, according to the capacity of the models. (common to both 3-phase and single-phase series)

- 1/8 to 1HP (0.1 to 0.75 kW) : Approx. 1 second
- 2 to 5HP (1.5 to 3.7 kW) : Approx. 2 seconds

Note : If a power loss exceeds the momentary power loss ride-thru time, low voltage fault occurs, fault contact is output and the motor coasts to a stop.

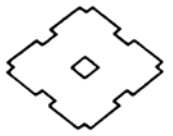

Operation when continuous operation after momentary power loss is provided is as described below :

- ① When undervoltage (UV) is detected, the inverter output is shut off and the frequency reference value and run command given before the momentary power loss are held.

Additionally, counting of the undervoltage time starts ; during counting, UV is displayed, blinking on the digital display unit and digital operator. If undervoltage is detected, the inverter output is shut off for the minimum baseblock time [55] sec.

- ② After recovery from the momentary power loss, after checking that the inverter DC voltage has recovered sufficiently, speed search operation is performed.
- ③ Speed search operation starts when the inverter output current exceeds the speed search operation level [54] set value. At this time, the new frequency reference value and run command are read in. The frequency in which the inverter output current is smaller than the speed search operation level [54] set value is judged to be the speed synchronized point, and reacceleration/redeceleration is performed up/down to the set frequency in the set accel/decel time.

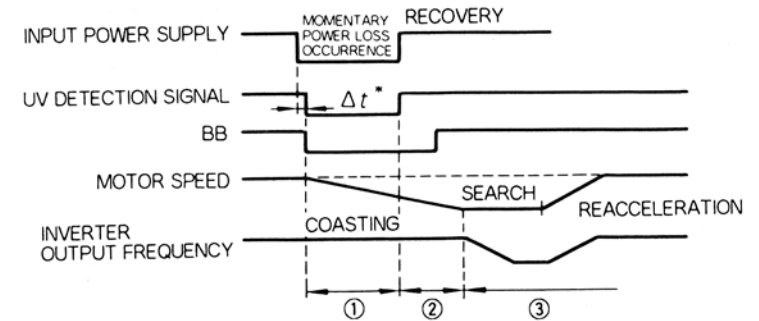

* Δt : Varies according to the inverter size. (Assured at 15 ms minimum.) Operation is automatically continued if recovery from momentary power loss in Δt or less.

- Do not provide an excessively small value for the minimum baseblock time setting. Otherwise, the inverter protective function may operate at search operation start. (Refer to page 108.)

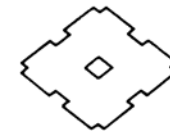

AUTOMATIC RESTART AFTER A FAULT

Item Name	Constant to be Set	Factory Preset
Fault Retry Selection	[47]	0
Speed Search Operation Level	[54]	150%
Minimum Baseblock Time	[55]	0.5 s
V/f during Speed Search	[56]	100%

If an inverter fault occurs during running, the inverter performs self-diagnosis to restart automatically.

The number of the self-diagnosis and restarting times can be set up to 10 times to [47]. By setting 0 times, the fault retry function becomes disabled.

The inverter restarts automatically in case of the following faults.

- ① Overcurrent protection (OC)
- ② Overvoltage protection (OV)
- ③ Cooling fin overheat (OH)

The number of fault retry times is cleared to 0 in the following cases :

- ① No fault occurs for more than 10 minutes
- ② Fault reset input signal (or  key on the digital operator) is turned ON when the fault is checked.
- ③ The power supply is turned OFF.

Fault retry operation is described below :

- ① If a fault is detected, the inverter output is shut off for the minimum baseblock time [55]. While the inverter output is shut off, the fault is displayed on the digital display unit and the digital operator.
- ② After the minimum baseblock time [55], the fault is automatically reset, and the speed search operation is performed from the output frequency at the fault occurrence.
- ③ If the inverter output current is larger than the speed search operation level [54] set value, the speed search operation starts. The frequency in which the inverter output current is smaller than the speed search operation level [54] set value is judged to be the speed synchronized point, and reacceleration/redeceleration is performed up/down to the set frequency in the set accel/decel time.
- ④ If the total number of faults exceeds the number of retry times [47], automatic reset is not performed and the inverter output is kept off. Then fault contact is output. (Fault contact is not output during fault retry.)

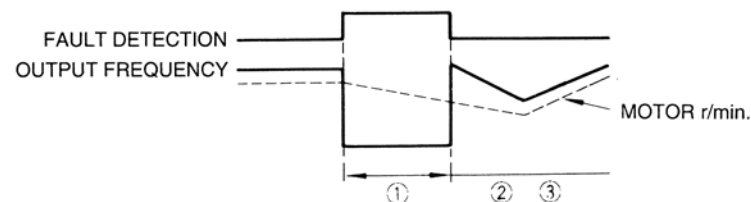

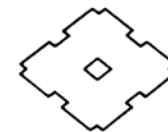

PROTECTIVE FUNCTIONS

ACCEL/DECEL HOLD COMMAND

Item Name	Constant to be Set	Factory Preset
Accel/Decel Hold Function	32, 33	See page 78.

When the accel/decel hold command is input during acceleration or deceleration, acceleration or deceleration is prohibited while the command is input, and the output frequency is held.

By inputting the stop command, the accel/decel command is released and the operation is in the stopped condition.

The accel/decel hold command is input from multifunction contact input terminal (ES) or (DF).

For the function of terminal (ES) or (DF), set "11" to 32 or 33.

To use terminal (ES) : Set 32.

To use terminal (DF) : Set 33.

The following shows the time chart when the accel/decel hold command is input :

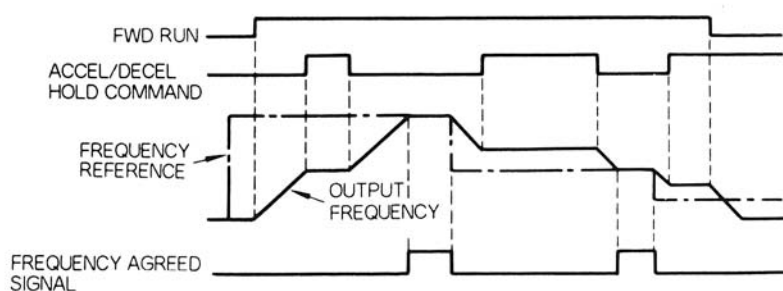

Note : When the FWD (REV) run command is input in the status where the accel/decel hold command is input, the baseblock status is continued and the motor does not operate.

However, when frequency reference lower limit 25 \geq minimum output frequency 7 is set, the motor operates at the frequency reference lower time 25.

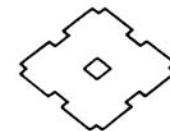

2.10 PROTECTIVE FUNCTIONS

Protective Function		Explanation	Monitor Display	Fault Output
Low Voltage Protection	Main Circuit Voltage Low	When the inverter power supply voltage drops, torque becomes insufficient and motor is overheated. Inverter output is stopped when the main circuit DC voltage becomes lower than the low voltage detection level. Detection level: Approx. 210 V or less (230 V, 3-phase), 170 V (240 V, single-phase), 420 V (460 V, 3-phase).	UV1 (UV1)	Operation
Overcurrent Protection		The inverter output is shut-off when the inverter output current becomes approx. 200% and above of inverter rated current.	OC (OC)	Operation
Ground-fault Protection		The inverter output is shut-off when a ground-fault occurs at the inverter output side.	GF (GF)	Operation
Overvoltage Protection		The inverter output is shut-off when the main circuit DC voltage becomes excessive because of regeneration energy caused by motor deceleration and negative load. Detection level: Approx. 410 V or more (230 V class 3-phase, 240 V class single-phase), 820 V or more (460 V class).	OV (OV)	Operation
Fuse Blown		The fuse clears to prevent wiring from being damaged by the short-circuit current when the main circuit transistor fails.	(Not displayed)	Non Operation
Cooling Fin Overheat (Only for Types of Forced Cooling)		The inverter output is shut-off when the cooling fin overheat is detected by thermistor. Check for a defective cooling fan or clogged filter.	OH (OH)	Operation

Protective Function		Error Causes	Action to be Taken
Low Voltage Protection	Main Circuit Voltage Low	<ul style="list-style-type: none"> Inverter capacity is too small. Voltage drop due to wiring. A motor of large capacity connected to the same power system has been started. Rapid acceleration with generator power supply Operation sequence when power is off Defective electromagnetic contactor 	<ul style="list-style-type: none"> Check the power supply voltage. Check the power capacity and power system.
Overcurrent Protection		<ul style="list-style-type: none"> Extremely rapid accel/decel Motor ON/OFF switching at the inverter output side Short-circuit at the inverter output side Motor of a capacity greater than the inverter rating has been started. High-speed motor or pulse motor has been started. 	Transistor error may occur. Investigate the error cause, correct it, then restart.
Ground-fault Protection		Ground-fault at the inverter output side.	<ul style="list-style-type: none"> Check that motor insulation is not deteriorated. Check that wiring of load side are not damaged.
Overvoltage Protection		<ul style="list-style-type: none"> Insufficient deceleration time Negative load (Motor is turned by the load.) High input voltage compared to motor rated voltage 	<ul style="list-style-type: none"> If braking torque is not proper, extend the decel time or connect a braking resistor unit (option). Check that the load is not minus. Check the power supply voltage.
Fuse Blown		<ul style="list-style-type: none"> Repeated overcurrent protection (OC) Repeated overload protection (OL2) power reset Rapid deceleration in excess excitation (improper V/f characteristic setting) 	<ul style="list-style-type: none"> Turn OFF the power supply once and turn it ON again. If the fault occurs again, replace the inverter. Do not replace the fuse.
Cooling Fin Overheat (Only for Types of Forced Cooling)		<ul style="list-style-type: none"> Defective cooling fan Intake air temperature rise Clogged filter 	<ul style="list-style-type: none"> Wash the filter. Replace the inverter when the inverter cooling fin is defective. Intake air temperature: 104° F (40°C) or less.

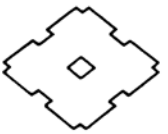

Protective Function		Explanation	Monitor Display	Fault Output
Over-load Protection	Motor	The inverter output is stopped when output current to the motor is detected by the electronic thermal in the inverter. Either a inverter duty constant-torque specialized motor or general-purpose motor can be selected. If more than two motors are driven, overload protection should be disabled. Use a thermal relay or thermal protector for each motor.	OL 1 (OL1)	Operation
	Inverter	The electronic thermal operates by the inverse time limit and the inverter output is shut-off when 105% or more of the inverter rated current occurs. Overload capacity : 150%, 1 min.	OL 2 (OL2)	Operation
	Over-torque Detection*	The motor operates according to operation selection [constant (No. 37)] when the inverter output current exceeds the overtorque detection level. This function is used to protect the machine or to monitor the output torque.	OL 3 (OL3)	Operation
External Fault Signal Input	When an external fault signal is input, the inverter output is shut-off.	EF3 (EF3) EF4 (EF4) EF5 (EF5)	Operation	
Control Circuit Fault †	The inverter output is shut-off when a transmission error occurs in the control circuit or a component fails.	CPFD0 † to CPFD5	Operation	

* For overtorque detection (OL3), fault display or alarm display can be selected according to the constant (No. 37) setting. For details, refer to "OVERTORQUE DETECTION FUNCTION" on page 101.

† For details of control circuit faults, refer to Table 1.9 "Details of CPF Display" on page 37.

‡ CPFD0 to 05 indicate the contents of digital operator display.

Protective Function		Error Causes	Action to be Taken
Over-load Protection	Motor	<ul style="list-style-type: none"> Overload, long operation at low speed, improper V/f characteristic setting. Motor rated current [constant (No. 19)] setting is wrong. 	<ul style="list-style-type: none"> Investigate the cause of overload and review the operation pattern, V/f characteristic, and motor/inverter capacities. (If inverter is repeatedly reset after an overload occurs, the inverter may fault. Investigate and correct the cause of overload before restart.) Set the rated current of motor nameplate value to constant (No. 19). If the above measures are not effective, lower the carrier frequency [constant (No. 40)].
	Inverter		
	Over-torque Detection*	Motor current exceeds the preset value because of machine error or overload.	
External Fault Signal Input	External fault condition occurred.	Correct the cause of the fault input.	
Control Circuit Fault †	<ul style="list-style-type: none"> External noise Excess vibration or shock 	<ul style="list-style-type: none"> Record all data of CPFD4, then make initialization. Turn OFF power, then turn ON again. If an error is persistent, replace the inverter. 	

* For overtorque detection (OL3), fault display or alarm display can be selected according to the constant (No. 37) setting. For details, refer to "OVERTORQUE DETECTION FUNCTION" on page 101.

† For details of control circuit faults, refer to Table 1.9 "Details of CPF Display" on page 37.

‡ CPFD0 to 05 indicate the contents of digital operator display.

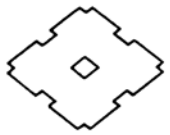

2.11 PROTECTIVE FUNCTIONS (WARNINGS)

Protective Function	Explanation	Monitor Display	Fault Contact Output
Low-voltage Protection (Main Circuit Voltage Insufficient)	Monitor display appears when the main circuit DC voltage drops under the detection level while the inverter output is off. Detection level : Approx. 210 V or less (230 V 3-phase) Approx. 170 V or less (240 V single-phase) Approx. 420 V or less (460 V 3-phase)	(UV) U U (Blink)	Non Operation
Overvoltage Protection	Monitor display appears when the main circuit DC voltage rises above the detection level while the inverter output is off. Detection level : Approx. 410 V or more (230 V class 3-phase, 240 V class single-phase) Approx. 820 V or more (460 V class)	(OV) O V (Blink)	Non Operation
Cooling Fin Overheat (Only for Types of Forced Cooling)	Monitor display appears when the cooling fin overheats : due to intake air temperature rise.	(OH) O H (Blink)	Non Operation
Overtorque Detection	This function is used to protect the machine and to monitor the inverter output torque. The motor operates according to selection of constant (No. 37) when the inverter output current exceeds the overtorque detection level. The monitor blinks when "operation continues" is preset.	(OL3) O L 3 (Blink)	Non Operation
Simultaneous Forward and Reverse Run Commands	When forward and reverse run commands are simultaneously closed for a period of time exceeding 500 ms, the inverter is stopped according to the preset stop method [constant (No. 01)]	(EF) E F (Blink)	Non Operation

Protective Function	Error Causes	Action to be Taken
Low-voltage Protection (Main Circuit Voltage Insufficient)	Input voltage drop	<ul style="list-style-type: none"> · Check the main circuit DC voltage. · Check the power supply capacity and power system.
Overvoltage Protection	Motor current exceeds the preset value because of machine error or overload.	Check the use of machine. Correct the overload cause or set a higher detection level [constant (No. 38)] which is within the allowable range.
Cooling Fin Overheat (Only for Types of Forced Cooling)	<ul style="list-style-type: none"> · Defective cooling fan · Intake air temperature rise · Clogged filter 	Replace the cooling fan and clean the filter. Intake air temperature : 104° F (40°C) or less
Overtorque Detection	Motor current exceeded the set value because of machine fault or overload.	Check the driven machine and correct the cause of the fault or increase the set value [constant (No. 38)] up to the machine allowable value.
Simultaneous Forward and Reverse Run Commands	<ul style="list-style-type: none"> · Operation sequence error · 3-wire/2-wire selection error 	<ul style="list-style-type: none"> · Recheck the control sequence. · Recheck constant settings (Nos. 32 and 33).

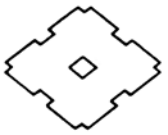

Protective Function	Explanation	Monitor Display	Fault Contact Output
External Baseblock Signal Input (Main Circuit Transistor Instantaneous Shut-off)	When an external baseblock signal is input, the motor coasts to a stop. When the external baseblock signal is removed, the inverter output is immediately turned on at the previously set frequency.	(BB) bb (Blink)	Non Operation
Stall Prevention Accel/Decel is Accomplished with Maximum Capacity of the Inverter without Tripping on Overcurrent or Overvoltage.	During Acceleration Inverter acceleration is stopped when 170% or more of the inverter rated current is required by the load. This prevents overload protection (OL1, OL2) or overcurrent (OC) from occurring. When current is reduced to less than 170%, acceleration is enabled.	—	Non Operation
	During Normal Operation Output frequency is decreased when 160% of the inverter rated current or greater is required by the load. This prevents motor and inverter overload (OL1, OL2). When current is reduced below 160%, inverter acceleration is enabled.		
	During Deceleration Deceleration is stopped when the DC voltage is caused to rise by motor regenerative energy. This prevents overvoltage trips (OV). When DC voltage decreases, deceleration to the set value resumes.		

Protective Function	Error Causes	Action to be Taken	
External Baseblock Signal Input (Main Circuit Transistor Instantaneous Shut-off)	—	—	
Stall Prevention Accel/Decel is Accomplished with Maximum Capacity of the Inverter without Tripping on Overcurrent or Overvoltage.	<ul style="list-style-type: none"> · Insufficient power for accel/ decel · Overload · Phase loss 	<ul style="list-style-type: none"> · Set proper accel/decel time [constant (Nos. 09 to 12)] for smooth operation. · For stall prevention during normal operation, lighten the load or increase inverter capacity. 	
			During Acceleration
			During Normal Operation
During Deceleration			