

BALDOR[®]
MOTORS AND DRIVES

Series 15P

Inverter Control

Installation and Operating Manual

Table of Contents

Section 1	
Quick Start	1-1
Section 2	
General Information	2-1
CE Compliance	2-1
Limited Warranty	2-1
Safety Notice	2-1
Section 3	
Receiving and Installation	3-1
Receiving & Inspection	3-1
Physical Installation	3-1
Control Installation	3-1
Electrical Installation	3-2
System Grounding	3-2
Input Current Requirements	3-2
Cover Removal	3-2
Terminal Identification	3-3
AC Line Connections	3-3
Protective Devices	3-3
Line Impedance	3-4
Line Reactors	3-4
Three Phase Wire Size and Protection Devices	3-5
115VAC 1 Phase Wire Size and Protection Devices	3-7
230VAC Single Phase Derating for Three Phase Controls	3-8
Motor Brake Connections	3-9
Optional Dynamic Brake Hardware	3-9
Analog Input	3-10
Digital Inputs	3-11
Section 4	
Setup and Operation	4-1
Overview	4-1
S1 Settings	4-2
Potentiometers P1 - P6	4-4
Operation Examples	4-5
Section 5	
Troubleshooting	5-1
Section 6	
Specifications and Product Data	6-1
Specifications	6-1
Operating Conditions:	6-1
Display:	6-2
Control Specifications:	6-2
Analog Input:	6-2
Digital Inputs:	6-2
Ratings	6-3
Dynamic Brake Resistors	6-3
Terminal Tightening Torque Specifications	6-3
Mounting Dimensions	6-4

Section 1

Quick Start

Overview

The quick start procedure is as follows:

1. Read the Safety Notice and Precautions in section 2 of this manual.
2. Mount the control. Refer to Section 3, “Physical Installation” procedure.
3. Connect AC power. Refer to Section 3 “Control Installation”.
4. Connect the motor. Refer to Section 3, “Control Installation”.
5. Set the switches and adjust the potentiometers for desired operation. See Figure 1-1.

The following procedure will help get your system up and running quickly, and will allow you to prove the motor and control operation. This procedure assumes that the control and motor are correctly installed.

⚠ WARNING: Make sure that unexpected operation of the motor shaft during start up will not cause injury to personnel or damage to equipment.

Power-up Procedure

1. Open cover.
2. Be sure all S1 switches are OFF.
3. Rotate the % Speed control on the front panel to 0% speed (fully counterclockwise position).
4. Turn power on. Be sure the “Fault” LED is off.
5. Press FWD. The LED on the FWD button should be on.
6. Rotate the % Speed control to 30%. The motor should rotate in the forward direction.

Note: If the motor rotates in the reverse direction, turn power off and reverse any two of the three motor lead connections (J5-T1, T2 or T3). Turn power on and start at step 3 again.

7. Press STOP. The motor should decel to a stop and the LED on the STOP button should be on.
8. Press REV. The LED on the REV button should be on.
9. Rotate the % Speed control to 30%. The motor should rotate in the reverse direction.
10. Turn power off.

The control is now ready to be configured for your application and placed into service. Refer to the appropriate connection diagram and setup procedure to configure your system.

Figure 1-1 Factory Settings

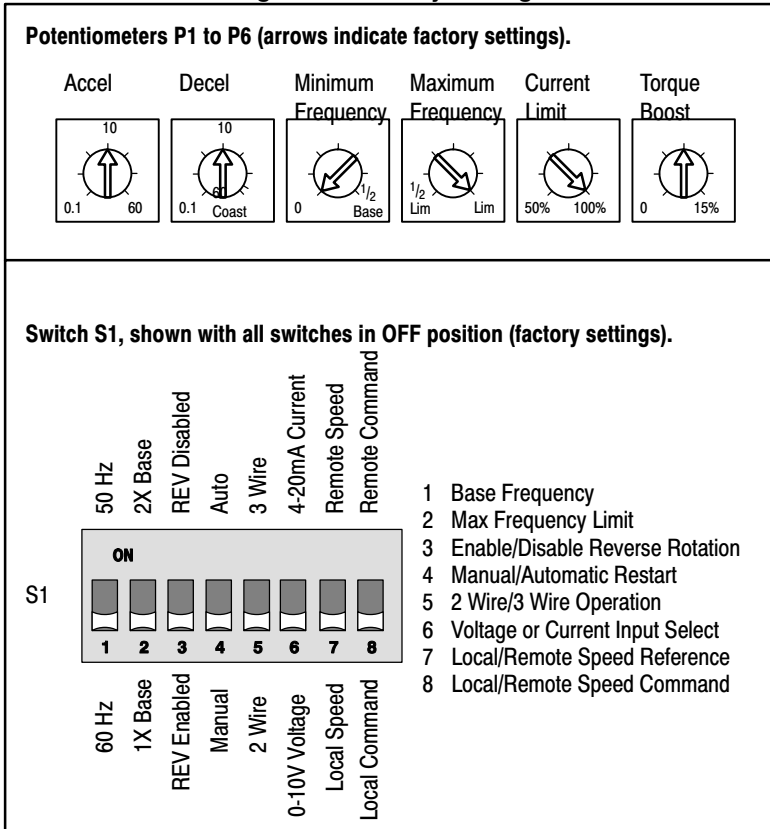

Section 2

General Information

CE Compliance

A custom unit may be required, contact Baldor. Compliance to Directive 89/336/EEC is the responsibility of the system integrator. A control, motor and all system components must have proper shielding, grounding and filtering as described in MN1383. Please refer to this manual for installation techniques for CE compliance.

Limited Warranty

For a period of two (2) years from the date of original purchase, BALDOR will repair or replace without charge controls and accessories which our examination proves to be defective in material or workmanship. This warranty is valid if the unit has not been tampered with by unauthorized persons, misused, abused, or improperly installed and has been used in accordance with the instructions and/or ratings supplied. This warranty is in lieu of any other warranty or guarantee expressed or implied. BALDOR shall not be held responsible for any expense (including installation and removal), inconvenience, or consequential damage, including injury to any person or property caused by items of our manufacture or sale. (Some states do not allow exclusion or limitation of incidental or consequential damages, so the above exclusion may not apply.) In any event, BALDOR's total liability, under all circumstances, shall not exceed the full purchase price of the control. Claims for purchase price refunds, repairs, or replacements must be referred to BALDOR with all pertinent data as to the defect, the date purchased, the task performed by the control, and the problem encountered. No liability is assumed for expendable items such as fuses.

Goods may be returned only with written notification including a BALDOR Return Authorization Number and any return shipments must be prepaid.

Safety Notice:

This equipment contains voltages that may be as great as 1000 volts! Electrical shock can cause serious or fatal injury. Only qualified personnel should attempt the start-up procedure or troubleshoot this equipment.

This equipment may be connected to other machines that have rotating parts or parts that are driven by this equipment. Improper use can cause serious or fatal injury.

PRECAUTIONS:

⚠ WARNING: Do not touch any circuit board, power device or electrical connection before ensuring that power has been disconnected and there is no high voltage present from this equipment or other equipment to which it is connected. Electrical shock can cause serious or fatal injury. Only qualified personnel should attempt the start-up procedure or troubleshoot this equipment.

⚠ WARNING: Be sure that you are completely familiar with the safe operation of this equipment. This equipment may be connected to other machines that have rotating parts or parts that are controlled by this equipment. Improper use can cause serious or fatal injury. Only qualified personnel should attempt the start-up procedure or troubleshoot this equipment.

Continued on next page.

-
- ⚠ WARNING:** Do not use motor overload relays with an automatic reset feature. These are dangerous since the process may injure someone if a sudden or unexpected automatic restart occurs. If manual reset relays are not available, disable the automatic restart feature using external control wiring.
- ⚠ WARNING:** This unit has an automatic power up start feature that will start the motor whenever input power is applied and a RUN (FWD or REV) command is issued and maintained. If an automatic power up start of the motor could cause injury to personnel, this feature should be turned off.
- ⚠ WARNING:** Be sure the system is properly grounded before applying power. Do not apply AC power before you ensure that grounds are connected. Electrical shock can cause serious or fatal injury.
- ⚠ WARNING:** Do not remove cover for at least five (5) minutes after AC power is disconnected to allow capacitors to discharge. Electrical shock can cause serious or fatal injury.
- ⚠ WARNING:** Motor circuit may have high voltage present whenever AC power is applied, even when motor is not rotating. Electrical shock can cause serious or fatal injury.
- ⚠ WARNING:** Dynamic brake resistors may generate enough heat to ignite combustible materials. Keep all combustible materials and flammable vapors away from brake resistors.
- ⚠ Caution:** Suitable for use on a circuit capable of delivering not more than 5,000 RMS symmetrical amperes, at rated voltage.
- ⚠ Caution:** Disconnect motor leads (T1, T2 and T3) from control before you perform a “Megger” test on the motor. Failure to disconnect motor from the control will result in extensive damage to the control. The control is tested at the factory for high voltage / leakage resistance as part of Underwriters Laboratories Inc. requirements.
- ⚠ Caution:** Do not connect AC power to the Motor terminals T1, T2 and T3. Connecting AC power to these terminals may result in damage to the control.
- ⚠ Caution:** Baldor recommends not using “Grounded Leg Delta” transformer power leads that may create ground loops. Instead, we recommend using a four wire Wye.

Section 3

Receiving and Installation

Receiving & Inspection

The Series 15P Inverter control is thoroughly tested at the factory and carefully packaged for shipment. When you receive your control, there are several things you should do immediately.

1. Observe the condition of the shipping container and report any damage immediately to the commercial carrier that delivered your control.
2. Verify that the control you received is the same as listed on your purchase order.
3. If the control is to be stored for several weeks before use, be sure that it is stored in a location that conforms to published storage specifications. (Refer to Section 6 of this manual).

Physical Installation

The mounting location is important. The control should be installed in an area that is protected from direct sunlight, corrosives, harmful gases or liquids, dust, metallic particles and vibration. Exposure to these elements can reduce the operating life and degrade performance of the control.

Several other factors should be carefully evaluated when selecting a location for installation:

1. For effective cooling and maintenance, the control should be mounted on a smooth, non-flammable vertical surface. Table 3-1 lists the Watts Loss ratings for enclosure sizing.
2. Provide at least two inches of clearance on all sides for airflow.
3. Front access must be provided to allow the control cover to be opened or removed for service and to allow viewing of the Keypad LEDs.
4. **Altitude derating.** Up to 3300 feet (1000 meters), no derating is required. Above 3300 feet, derate peak or continuous output current by 2% for each 1000 feet above 3300 feet.
5. **Temperature derating.** Up to 40°C, no derating is required. Above 40°C, derate peak or continuous output current by 2% per °C above 40°C.
Maximum ambient is 55°C.

Table 3-1 Series 15P Watts Loss Ratings

115VAC		230VAC		460VAC	
2.5kHz PWM	7.5kHz PWM	2.5kHz PWM	7.5kHz PWM	2.5kHz PWM	7.5kHz PWM
17 Watts/ Amp	20 Watts/ Amp	17 Watts/ Amp	20 Watts/ Amp	19 Watts/ Amp	28 Watts/ Amp

Control Installation

The control must be securely fastened to the mounting surface. Use the four (4) mounting holes to fasten the control to the mounting surface or enclosure.

Shock Mounting

If the control will be subjected to levels of shock greater than 1G or vibration greater than 0.5G at 10 to 60Hz, the control should be shock mounted. Excessive vibration within the control can cause internal connections to loosen and could lead to component failure or electrical shock hazard.

Electrical Installation

Interconnection wiring is required between the motor control, AC power source, motor, host control and any operator interface stations. Use UL listed closed loop connectors that are of an appropriate size for the wire gauge being used. Connectors are to be installed using crimp tool specified by the manufacturer of the connector. Only Class 1 wiring should be used.

System Grounding

Baldor controls are designed to be powered from standard three phase lines that are electrically symmetrical with respect to ground. System grounding is an important step in the overall installation to prevent problems.

Input Current Requirements

Table 3-2 Input Current Requirements for Stock Products

115VAC - 1 ϕ		230VAC - 3 ϕ		460VAC - 3 ϕ	
Catalog Numbers	Input Amps	Catalog Numbers	Input Amps	Catalog Numbers	Input Amps
ID15P1F33-ER	3.5	ID15P201-ER	4.5	ID15P401-ER	2.5
ID15P1F50-ER	5.0	ID15P201F5-ER	7.0	ID15P401F5-ER	3.5
ID15P1F75-ER	7.5	ID15P202-ER	8.0	ID15P402-ER	4.0
ID15P101-ER	10.0	ID15P203-ER	11.0	ID15P403-ER	5.5
		ID15P205-ER	15.0	ID15P405-ER	9.0
				ID15P407-ER	10.0
				ID15P410V-ER	13.0

Cover Removal

The cover is made of plastic and could be damaged during removal if handled roughly. Refer to Figure 3-1. Insert a screw driver or small blade tool and pry the cover outward as shown to release the side. When both sides are released, remove the cover.

Figure 3-1 Cover Removal

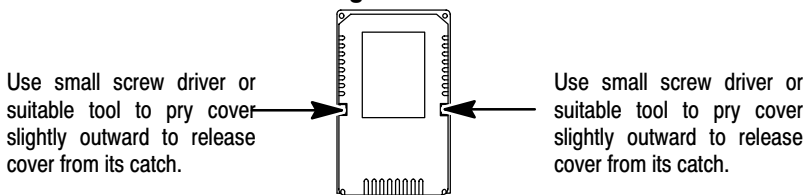

Terminal Identification

The terminals for signal, AC power and motor connections are shown in Figure 3-2. Separate ground connections are provided for power and motor grounds.

Figure 3-2 Terminal Identification

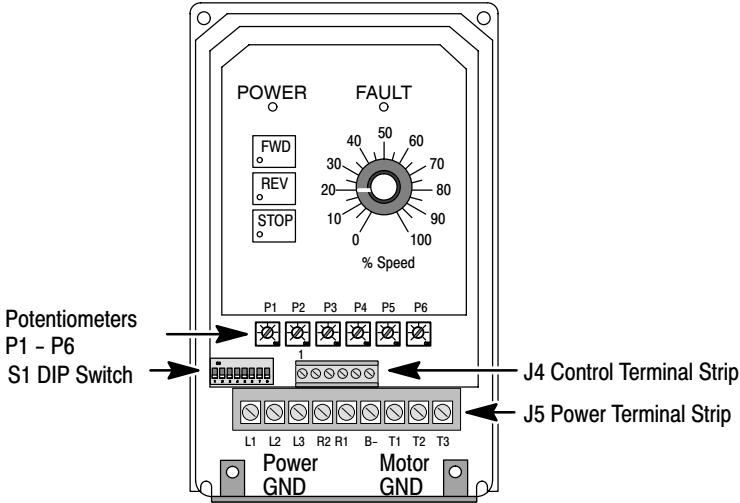

AC Line Connections

A power disconnect should be installed between the input power service and the control for a fail-safe method to disconnect power. The control will remain in a powered-up condition until all input power is removed from the control and the internal bus voltage is discharged.

Protective Devices

Recommended fuse sizes are based on the following:

115% of maximum continuous current for time delay.

150% of maximum continuous current for Fast or Very Fast action.

Note: These general size recommendations do not consider harmonic currents or ambient temperatures greater than 40°C.

Be sure a suitable input power protection device is installed. Use the recommended fuses listed in Tables 3-4 and 3-5 (Wire Size and Protection Devices). Input and output wire size is based on the use of copper conductor wire rated at 75 °C. The table is specified for NEMA B motors.

Fast Action Fuses: 115/230VAC, Buss KTN
460VAC, Buss KTS

Very Fast Action Fuses: 115/230VAC, Buss JJN
460VAC, Buss JJS

Time Delay Fuses: 115/230VAC, Buss FRN
460VAC, Buss FRS

Line Impedance

The Baldor Series 15J control requires a minimum line impedance of 1%. The input impedance of the power lines can be determined as follows:

Measure the line to line voltage at no load and at full rated load. Use these measured values to calculate impedance as follows:

$$\% \text{Impedance} = \frac{(\text{Volts}_{\text{NoLoad}} - \text{Volts}_{\text{FullLoad}})}{(\text{Volts}_{\text{NoLoad}})} \times 100$$

Table 3-3 Recommended Line Reactors

230VAC, 60Hz, 3% Impedance				460VAC, 60Hz, 3% Impedance			
Catalog No.	HP	Amps	Inductance (mH)	Catalog No.	HP	Amps	Inductance (mH)
LRAC00401	1	4	3	LRAC00202	1	2	12
LRAC00801	1.5	8	1.15	LRAC00202	1.5	2	12
LRAC00801	2	8	1.15	LRAC00402	2	4	6.5
LRAC01201	3	12	1.25	LRAC00402	3	4	6.5
LRAC01801	5	18	0.8	LRAC00802	5	8	3.0
LRAC3501	7.5	25	0.5	LRAC01202	7.5	12	2.5
				LRAC01802	10	18	1.5

Line Reactors

3 phase line reactors are available from Baldor. The size of the line reactor to use is based on the maximum continuous load. If providing your own line reactor, use the following formula to calculate the minimum inductance required. Table 3-2 lists the input current required for this calculation. Line reactors may be used at the control output to the motor. When used this way, they are called Load Reactors.

$$L = \frac{(V_{L-L} \times 0.01)}{(I \times \sqrt{3} \times 377)}$$

Where: L Minimum inductance in henrys.
V_{L-L} Input volts measured line to line.
0.01 Desired percentage of input impedance (1% shown).
I Input current rating of control.
377 Constant used with 60Hz power.
Use 314 with 50Hz power.

Three Phase Wire Size and Protection Devices

Table 3-4 Wire Size and Protection Devices - 3 phase

Control Rating		Input Fuse		Wire Gauge	
Input Volts	Output HP	Fast Acting Amps	Time Delay Amps	AWG	mm ²
230	1	6	5	14	2.08
230	1.5	8	7	14	2.08
230	2	12	9	14	2.08
230	3	15	12	14	2.08
230	5	25	20	12	3.31
460	1	3	2.5	14	2.08
460	1.5	4	3.5	14	2.08
460	2	5	4.5	14	2.08
460	3	8	6.3	14	2.08
460	5	12	10	14	2.08
460	7.5	17.5	15	14	2.08
460	10.0	20	17.5	12	3.31

Note: All wire sizes are based on 75°C copper wire, 1% line impedance.

Figure 3-3 Three Phase AC Power and Motor Connections

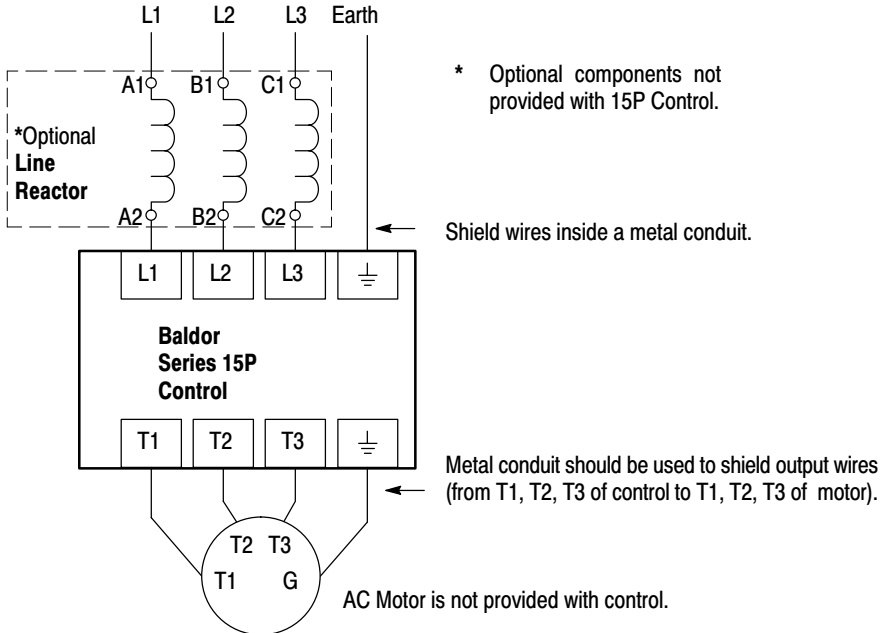

115VAC 1 Phase Wire Size and Protection Devices

Table 3-5 Wire Size and Protection Devices - 1 phase

Control Output Rating HP	Input Fuse		Wire Gauge	
	Fast Acting Amps	Time Delay Amps	AWG	mm ²
0.33	10	10	14	2.08
0.5	10	10	14	2.08
0.75	15	10	14	2.08
1.0	20	15	14	2.08

Note: All wire sizes are based on 75°C copper wire, 1% line impedance.

Figure 3-4 Single Phase AC Power and Motor Connections

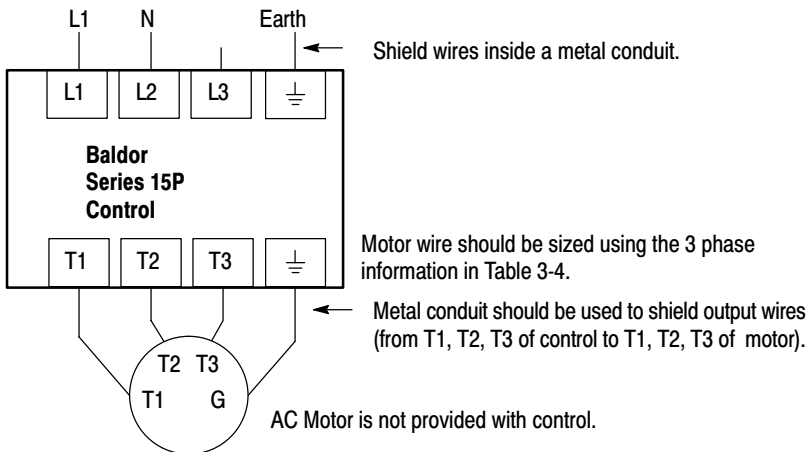

230VAC Single Phase Derating for Three Phase Controls

Single phase AC input power can be used to power a three phase control. However, the continuous and peak current ratings of the control must be reduced by 35% (derated).

Control Output Rating HP	Input Fuse		Wire Gauge	
	Fast Acting Amps	Time Delay Amps	AWG	mm ²
0.75	10	9	14	2.08
1	12	10	14	2.08
1.5	15	15	14	2.08
2	20	17.5	14	2.08
3	25	25	12	3.31

Note: All wire sizes are based on 75°C copper wire, 1% line impedance.

Figure 3-5 Single Phase 230VAC Power and Motor Connections

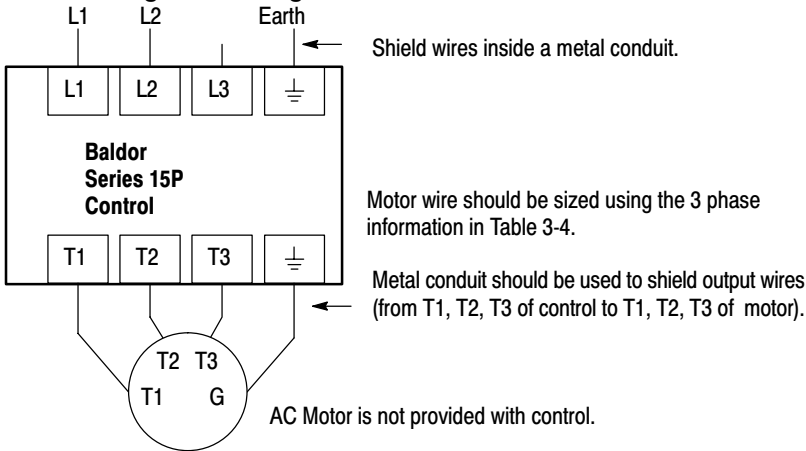

Motor Brake Connections

For motors with spring set brakes, connect the brake power leads and the motor power leads separately. Because the inverter has variable voltage output to the motor, the inverter may not supply enough power at low frequencies for proper brake operation. If using a motor with an internally connected brake, the brake power leads must be connected to a separate power source for proper brake operation. Refer to Figure 3-2 for terminal locations.

Optional Dynamic Brake Hardware

Dynamic Brake (DB) Hardware must be installed on a flat, non-flammable, vertical surface to obtain effective cooling and operation. The ambient temperature must not exceed 80°C. DB connections are shown in Figure 3-6.

Figure 3-6 Wiring for RGA Assembly

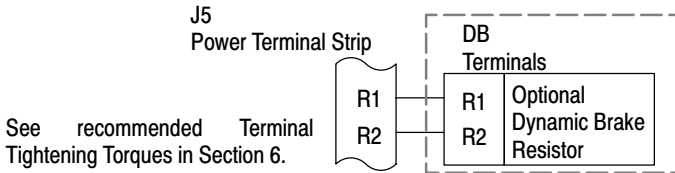

Note: Although not shown, metal conduit should be used to shield all power wires and motor leads.

General Machinery Load Calculations:

1. Calculate braking duty cycle:

$$\text{Duty Cycle} = \frac{\text{Braking Time}}{\text{Total Cycle Time}}$$

2. Calculate deceleration torque:

$$T_{\text{Decel}} = \frac{\text{RPM change} \times Wk^2}{308 \times \text{time}} - \text{Friction}_{(\text{Lb.Ft.})}$$

where: T_{Decel} = Deceleration torque in lb-ft.
 Wk^2 = Inertia in lb-ft²
time = In seconds

3. Calculate watts to be dissipated in dynamic braking resistor:

$$\text{Watts} = T_{\text{Decel}} \times (S_{\text{max}} - S_{\text{min}}) \times \text{Duty Cycle} \times (0.0712)$$

where: S_{max} = Speed to start braking
 S_{min} = Speed after braking

4. Multiply watts calculated in step 3 by 1.25 to allow for unanticipated loads (safety factor).

Analog Input

(S1-7 = OFF)

If S1-7 is OFF, the front panel % Speed potentiometer is selected. The J4 inputs are ignored.

(S1-7 = ON)

One analog input is available at J4-2 and J4-1 as shown in Figure 3-7. The input may be connected to a potentiometer as shown or an input signal can be applied to pin J4-2. The analog signal can be 0-10VDC or 4-20 mA as selected by S1-6 (see Table 3-6).

Note: A potentiometer value of 5k Ω to 10k Ω , 0.5 watt may be used.

Figure 3-7 Analog Input

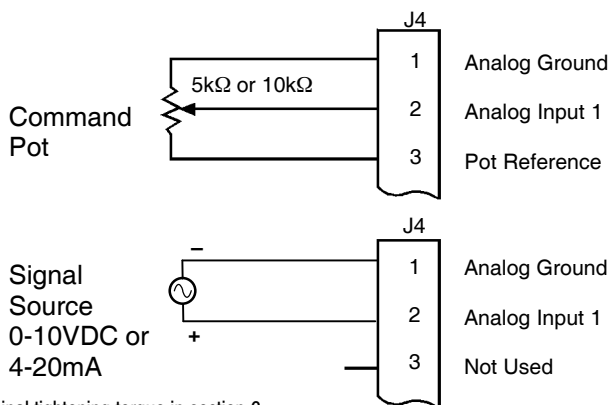

See recommended terminal tightening torque in section 6.

Table 3-6 S1-6 Switch Settings

S1-6	J4 Description
“OFF” Voltage Mode	J4-1 is ground. J4-2 accepts a 0-10VDC input (from a potentiometer or other signal source).
“ON” Current Mode	J4-1 is negative side of the 4-20mA connection. J4-2 is positive side of the 4-20mA connection.

Digital Inputs

(S1-8 = OFF)

If S1-8 is OFF, the front panel commands FWD, REV and STOP are selected. The J4 inputs are ignored.

(S1-8 = ON)

Three inputs are available on the J4 connector. Switch S1-5 determines whether two wire or three wire operation is used. If two wire is selected (S1-5= OFF) the STOP input at J4-6 is not used.

Note: Pressing the STOP switch on the front panel keypad will override the J4 commands and cause the motor to decel to a stop.

2 Wire Operation of Digital Inputs (S1-5 = OFF)

J4-4 Forward

Open – Disables forward operation.
Decel to stop.

Closed – Starts forward motor rotation.

J4-5 Reverse

Open – Disables reverse operation.
Decel to stop.

Closed – Starts reverse motor rotation.

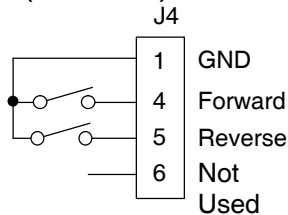

3 Wire Operation of Digital Inputs (S1-5 = ON)

J4-4 Forward

Momentary Closed – Starts forward motor rotation.

J4-5 Reverse

Momentary Closed – Starts reverse motor rotation.

J4-6 Stop

Momentary Open – Motor decels to stop.

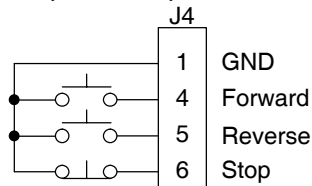

Note: Simultaneous closure of J4-4 and J4-5 will cause the motor to decel to stop if the motor is running. If the control is in a fault condition, simultaneous closure of these inputs will attempt a fault reset.

Section 4

Setup and Operation

Overview The operator interface panel is shown in Figure 4-1.

Figure 4-1 Operator Interface

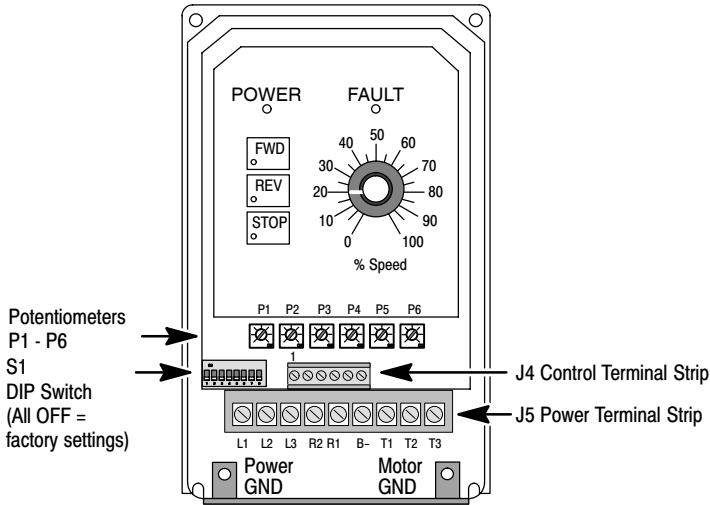

POWER

LED is on when AC input power is applied to the control.

FAULT

LED is on when a fault condition is present in the control.

FWD

Press FWD to initiate forward rotation of the motor, in local command mode.

LED is on when control is in forward run mode.

REV

Press REV to initiate reverse rotation of the motor, in local command mode.

LED is on when control is in reverse run mode.

STOP

Press STOP to initiate a stop sequence, in local or remote modes. Depending on the setting of potentiometer P2, the motor will either ramp or coast to a stop. The LED is on when the control is in stop mode.

S1 Settings (OFF = Open; ON = Closed)

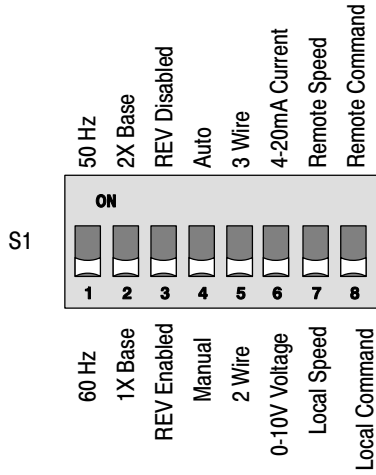

S1 Settings Continued

Switch	Setting	Description
1	OFF	Base Frequency = 60Hz
	ON	Base Frequency = 50Hz
2	OFF	Maximum frequency limit = Base Frequency (60/50Hz)
	ON	Maximum frequency limit = 2 X Base Frequency (130 or 110 Hz)
3	OFF	Reverse motor rotation ENABLED
	ON	Does not allow reverse motor rotation
4	OFF	Power up Start DISABLED (see notes)
	ON	Power up Start ENABLED the control will resume operation as soon as power is applied. Power up start is disabled the first time you power up the drive (see notes).
5	OFF	Terminal 2 wire mode (If S1-8 = ON)
	ON	Terminal 3 wire mode (If S1-8 = ON)
6	OFF	Analog input VOLTAGE (if S1-7 = ON)
	ON	Analog input CURRENT (if S1-7 = ON)
7	OFF	Use local speed reference (front panel potentiometer)
	ON	Use remote speed reference (J4 connector)
8	OFF	Use local commands (front panel FWD, REV, STOP)
	ON	Use remote commands (J4 connector)

Note 1: If power up start is ON and local commands are used, the drive will resume operation in the same FWD or REV direction when power is applied.

Note 2: If power up start is ON and remote 2 wire commands are used, the drive will resume operation if the forward or reverse switch is still closed (2 wire).

Note 3: If power up start is ON and remote 3 wire commands are used, the drive will not allow power up start operation (unless the momentary contacts stop and forward or reverse are manually held closed during power up).

Note 4: After power down, if any S1 switch position is changed, power up start is cancelled.

Potentiometers P1 - P6 (270° of rotation)

Refer to Figure 4-1 for location of potentiometers.

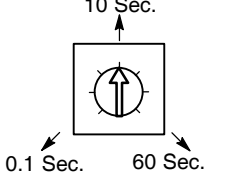
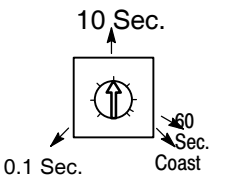
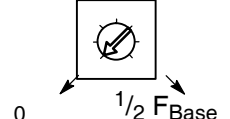
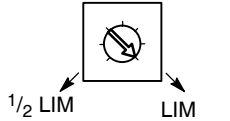
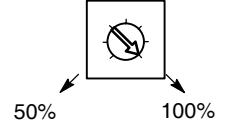
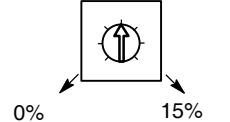
<p>ACCEL time – P1 The time required to reach the Maximum Frequency setting of P4. Accelerates at a linear rate. First half (0 to 135°) = 0.1 sec to 10 sec last half (135 - 270°) = 10 sec to 60 sec</p>	
<p>DECEL time – P2 The time required to ramp to a stop. Decelerates at a linear rate. First half (0 to 135°) = 0.1 sec to 10 sec last half (135 - 265°) = 10 sec to 60 sec (265 - 270°) = Coast - Allows motor to coast to stop.</p>	
<p>Minimum frequency – P3 Sets the minimum output frequency to the motor. This is a percentage of the S1-1 base frequency setting.</p>	
<p>Maximum frequency – P4 Sets the maximum output frequency to the motor. This is a percentage of the S1-2 frequency limit setting.</p>	
<p>Current Limit – P5 50% to 100% of control rated amps (see output current rating in Section 6).</p>	
<p>Torque Boost – P6 Increases the nominal motor starting voltage from 0 to 15% to increase starting torque.</p>	

Operation Examples

Operating the Control from the Front Panel

To place the control in local speed and command mode, place S1-7 and S1-8 in the OFF position. Refer to Figure 4-1 for switch location.

Table 4-1 Active Switches for Local Operation

S1	Pos.	Position and Description
7	OFF	Local Speed Reference (front panel potentiometer)
8	OFF	Local command input (front panel FWD, REV, STOP)

The control can operate as follows:

1. Set the P1 through P6 potentiometers as desired.
2. Set switches S1-1, S1-2, S1-3 and S1-4 as desired.
3. Adjust the motor's speed using the potentiometer on the front panel.
4. Press the FWD or REV keys on the front panel.
5. Press STOP on the front panel to stop motor rotation.

Note: S1-7 and S1-8 can be set so that either or both can be local or remote inputs. The front panel potentiometer can be used with remote command inputs by placing S1-7 OFF and S1-8 ON. Also, a remote speed reference can be used while the front panel switches are used by placing S1-7 ON and S1-8 OFF.

Speed Adjustment using a Remote Speed Reference

To use an external potentiometer or other signal source, refer to Figures 4-2, 4-3 and 4-4.

Figure 4-2 Remote Potentiometer 2 Wire Operation

S1	Pos.	Description
5	OFF	2 Wire
6	OFF	Voltage mode
7	ON	Remote Speed Ref.
8	ON	Remote commands

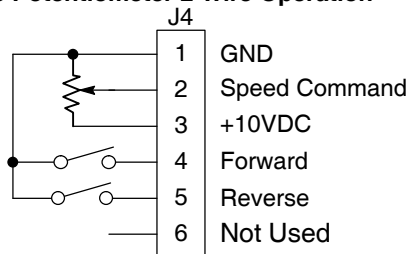

1. Set the P1 through P6 potentiometers as desired.
2. Set switches S1-1, S1-2, S1-3 and S1-4 as desired.
3. Close the FWD or REV key (both Open = Stop).
4. Adjust the motor's speed using the potentiometer at J4-2.
5. Press STOP on the front panel to stop motor rotation.

Figure 4-3 Remote 0-10VDC 3 Wire Operation

J4

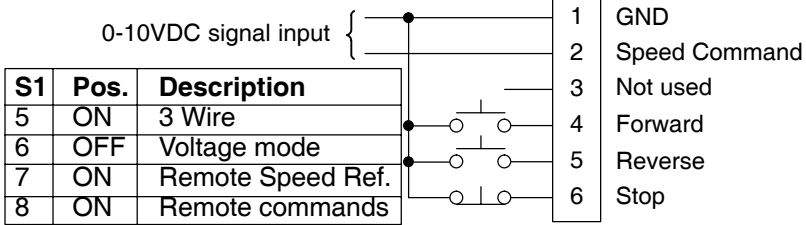
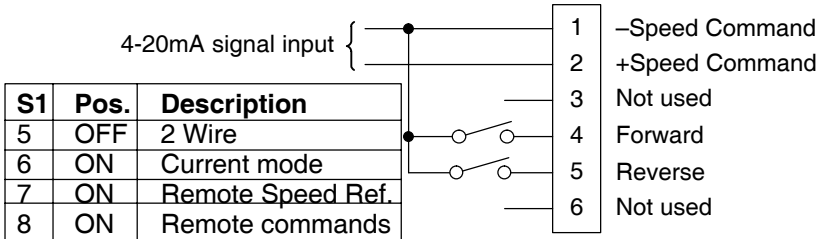

Figure 4-4 Remote 4-20mA 2 Wire Operation

J4



Section 5 Troubleshooting

The Baldor Series 15P Control requires very little maintenance, if any, and should provide years of trouble free operation when installed and applied correctly. Occasional visual inspection to ensure tight wiring connections and cleaning to remove dust, dirt, or foreign debris which can reduce heat dissipation should be considered.

Operational failures called faults are displayed on the LED's as they occur. Procedures in this section describe how to recognize a fault and restore normal operation.

Before service is performed, all input power must be removed from the control to avoid electrical shock hazard. Most troubleshooting can be performed using only a digital voltmeter having an input impedance exceeding 1 megohm. In some cases, an oscilloscope with 5 MHz minimum bandwidth may be useful. Before consulting the factory, check that all power and control wiring is correct and installed per the recommendations given in this manual.

Figure 5-1 LED Identification

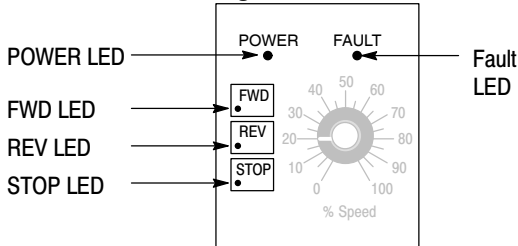

Fault Code Determination

When the Fault LED is blinking, a failure has been detected. One of five fault codes is displayed by the flashing Fault LED. To determine the fault code, carefully observe the blinking pattern. The blinking (2Hz rate) should stop for 1.5 seconds. This 1.5 second pause is the start of the display sequence. Count the number of blinks that occur between the 1.5 second pauses. One blink = Fault code 1, two blinks = fault code 2 etc. When the fault code is determined, refer to Fault Code Descriptions.

Fault Code Descriptions

Five fault codes can be displayed. Carefully examine all LED's (Power, Fault, FWD, REV and Stop) to determine the cause of the fault condition. Press Stop to reset the control.

Fault Code 1 – Non Resettable hardware fault (Power LED is blinking).

May indicate a HW Surge Current, HW Protect or a Power Module fault is detected.

Power LED	Fault LED	Action
Blinking	1 Blink	a. Check wiring to ensure a ground fault is not present. b. Make sure the load is not excessive.

Fault Code 2 – 2 or 60 second Overload or a % Overload Timer fault.

2 or 60 Second Overload May indicate an overcurrent condition but the control has not tripped, the FWD or REV LED is blinking.

FWD or REV LED	Fault LED	Action
Blinking	2 Blinks	Press Stop to reset the control. If error remains, try these steps to correct the fault. (You may have to wait for the % Overload timer to expire if the STOP LED is blinking). a. Verify proper sizing of control and motor. b. If error occurred while ramping motor, check motor, coupling and load. c. Increase ACCEL time (P1). d. Increase/Decrease Torque Boost value (P6).

% Overload Timer Indicates that fault code 2 has occurred to many times and the control needs to cool down. The STOP LED blinks, a timer begins and all drive operations are suspended until 100% Overload capacity is regained.

STOP LED	Fault LED	Action
Blinking	2 Blinks	

During this error, the drive is not resettable. When the drive reaches 100% Overload left, the fault LED will continue to blink, however, the STOP LED will remain continuously ON.

Fault Code 3 – Bus faults. May indicate an Over-voltage, Under-voltage or Precharge fault was detected.

Power LED	Fault LED	Action
ON	3 blinks	Press Stop to reset the control. If error remains, try these steps to correct the fault. <ol style="list-style-type: none"> Lengthen DECEL time (P2). Add external dynamic braking assemblies. Correct problem with motor load. Check dynamic brake hardware wiring. Verify proper AC line voltage. May need step down transformer or line reactor. Check power line disturbances (sags caused by start-up of other equipment). Monitor power line fluctuations with date and time imprint to isolate power problem.

Fault Code 4 – Dynamic Brake or Over-temperature faults.

Power LED	Fault LED	Action
ON	4 Blinks	Press Stop to reset the control. If error remains, try these steps to correct the fault. <ol style="list-style-type: none"> Correct motor loading. Verify proper sizing of control, motor and brake resistor. Relocate control to a cooler operating area. Add cooling fans or air conditioner to control cabinet. Remove debris from fan and heatsink surfaces. Verify fan operation. Replace fan or check fan wiring.

Fault Code 5 – Microprocessor faults. May indicate a Communication timeout, incompatible front end and power boards, EEPROM or Power Base ID fault was detected.

Power LED	Fault LED	Action
ON	5 Blinks	Cable defect or other internal problem.

- Press Stop to reset the control.
- Turn power OFF then ON (cycle power). If fault remains call Baldor.

Section 6

Specifications and Product Data

Specifications:

Horsepower	0.33-1HP @ 115VAC 1-5 HP @ 230VAC 1-5 HP @ 460VAC
Input Frequency	50/60Hz \pm 5%
Output Voltage	0 to Maximum Input Voltage (RMS)
Output Current	See Ratings Table
Output Frequency	0 to 130Hz
Service Factor	1.0
Duty	Continuous
Overload Capacity	Constant Torque Mode: 200% for 2 seconds 150% for 60 seconds
Frequency Setting	0-10VDC, 4-20mA or the front panel potentiometer
Frequency Setting Potentiometer	5k Ω or 10k Ω , 1/2 Watt
Rated Storage Temperature:	- 30°C to +65°C

Operating Conditions:

Voltage Range:	
115 VAC Models	90-132 VAC 1 ϕ 60/50Hz
230 VAC Models	180-264 VAC 3 ϕ 60Hz/180-230 VAC 3 ϕ 50Hz
460 VAC Models	342-528 VAC 3 ϕ 60Hz/342-457 VAC 3 ϕ 50Hz
Input Line Impedance:	1% Minimum Required
Ambient Operating Temperature:	0 to +40°C Derate Output 2% per °C over 40°C to 55°C (130°F) Maximum
Enclosure:	NEMA 1: ER (suffix) Models
Humidity:	NEMA 1: To 90% RH non-condensing
Altitude:	Sea level to 3300 feet (1000 meters) Derate 2% per 1000 feet (303 meters) above 3300 feet
Shock:	1G
Vibration:	0.5G at 10Hz to 60Hz
LED Indicators	Power Fault Forward run command Reverse run command Stop command

Display:**Control Specifications:**

Control Method	Sine wave Carrier input, PWM output
PWM Frequency	Rated @ 7.5kHz
V/Hz Ratio	Linear with adjustable Torque Boost
Transistor Type	IGBT (Insulated Gate Bipolar Transistor)
Torque Boost	0 to 15% adjustable
Brake Torque	Up to 60%, external resistor required
Accel/Decel Time	Separate rates, 0.1 to 60 sec.
Base Frequency	50 or 60Hz
Frequency Setting	0-10VDC, 4-20mA, and Rotary on front panel
Accel/Decel	Separate Accel/Decel rates (0.1 - 60 seconds)
Auto Start	ON or OFF
Protective Functions	Inverter trip – Over voltage, over current, under voltage, motor overload Short Circuit – Phase to phase and phase to ground

Analog Input:

Potentiometer Input	0 - 10VDC
Input Full Scale Range	0-10VDC and 4-20mA
Differential Input Common Mode Rejection	40db
Input Impedance	20k Ω

Digital Inputs: (3 Inputs)

Digital Inputs	Forward Reverse Stop
Input Impedance	6.8k Ω (Closed contacts standard)
Leakage Current	10 μ A Maximum

Ratings Series 15P Stock Products

Catalog No.	Rated Input Volts	Rated Output Volts	HP	kW	Output Current		
					Continu-ous	60 Sec. Overload	2 Sec. Overload
ID15P1F33-ER	115	230	0.33	0.25	1.6	2.4	3.2
ID15P1F50-ER	115	230	0.5	0.37	2.3	3.5	4.6
ID15P1F75-ER	115	230	0.75	0.56	3.2	4.8	6.4
ID15P101-ER	115	230	1.0	0.75	4.2	6.3	8.4
ID15P201-ER	230	230	1	0.75	4.2	6.3	8.4
ID15P201F5-ER	230	230	1.5	1.1	6.0	9.0	12.0
ID15P202-ER	230	230	2	1.5	6.8	10.2	13.4
ID15P203-ER	230	230	3	2.2	9.6	14.4	19.2
ID15P205-ER	230	230	5	3.7	15.2	22.8	30.4
ID15P401-ER	460	460	1	0.75	2.1	3.2	4.2
ID15P401F5-ER	460	460	1.5	1.1	3.0	4.5	6.0
ID15P402-ER	460	460	2	1.5	3.4	5.1	6.8
ID15P403-ER	460	460	3	2.2	4.8	7.2	9.6
ID15P405-ER	460	460	5	3.7	7.6	11.4	15.2
ID15P407-ER	460	460	7.5	5.6	11.0	16.5	22.0
ID15P410V-ER	460	460	10.0	7.6	14.0	16.1	16.1

Note: All specifications are subject to change without notice.

Dynamic Brake Resistors

Table 6-2 Dynamic Braking Resistor Assemblies (RGJ)

Control VAC	Minimum Ohms	Continuous Rated Watts						
		100	200	300	600	1200	2400	4800
115/230	60	RGJ160	RGJ260	RGJ360	RGA660	RGA1260	RGA2460	RGA4860
460	120	RGJ1120	RGJ2120	RGJ3120	RGA6160	RGA12120	RGA24120	

Terminal Tightening Torque Specifications

Table 6-3 Torques for "ER"

Control Voltage Rating VAC	Tightening Torque			
	Control Terminals (J4)		Power Terminals (J5)	
	Lb-in	Nm	Lb-in	Nm
115, 230 and 460	4	0.45	7	0.8

Mounting Dimensions

inches (mm)

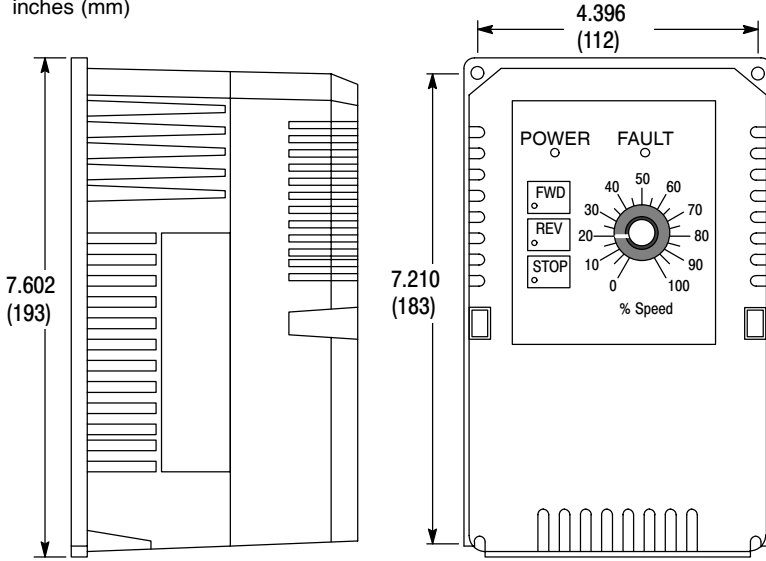

For mounting, use four #8 x 1-3/8" long screws.

- A = 5.660 (144) for 230VAC, 5hp and 460VAC 7.5 & 10hp
- A = 4.910 (125) all other sizes
- B = 4.886 (124) for 230VAC, 5hp and 460VAC 7.5 & 10hp
- B = 4.834 (123) all other sizes

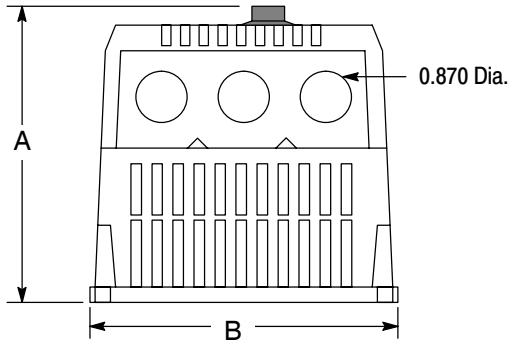

OM000A03,
OM001A13

**Baldor District Offices
UNITED STATES**

ARIZONA
PHOENIX
4211 S 43RD PLACE
PHOENIX, AZ 85040
PHONE: 602-470-0407
FAX: 602-470-0464

CALIFORNIA
LOS ANGELES
6480 FLOTILLA
COMMERCE, CA 90040
PHONE: 323-724-6771
FAX: 323-721-5859

HAYWARD
21056 FORBES STREET
HAYWARD, CA 94545
PHONE: 510-785-9900
FAX: 510-785-9910

COLORADO
DENVER
2520 W BARBERY PLACE
DENVER, CO 80204
PHONE: 303-623-0127
FAX: 303-595-3772

CONNECTICUT
WALLINGFORD
65 SOUTH TURNPIKE ROAD
WALLINGFORD, CT 06492
PHONE: 203-269-1354
FAX: 203-269-5485

FLORIDA
TAMPA/PUERTO RICO/
VIRGIN ISLANDS
3906 EAST 11TH AVENUE
TAMPA, FL 33605
PHONE: 813-248-5078
FAX: 813-247-2984

GEORGIA
ATLANTA
62 TECHNOLOGY DR.
ALPHARETTA, GA 30005
PHONE: 770-772-7000
FAX: 770-772-7200

ILLINOIS
CHICAGO
1601FRONTENAC ROAD
NAPERVILLE, IL 60563
PHONE: 630-848-5100
FAX: 630-848-5110

INDIANA
INDIANAPOLIS
5525 W. MINNESOTA ST.
INDIANAPOLIS, IN 46241
PHONE: 317-246-5100
FAX: 317-246-5110
800-428-4141

IOWA
DES MOINES
1901 BELL AVE., SUITE 7
DES MOINES, IA 50315
PHONE: 515-244-9996
FAX: 515-244-6124

MARYLAND
BALTIMORE
6660 SANTA BARBARA RD
SUITE 22-24
ELKRIDGE, MD. 21075
PHONE: 410-579-2135
FAX: 410-579-2677

MASSACHUSETTS
BOSTON
6 PULLMAN STREET
WORCESTER, MA 01606
PHONE: 508-854-0708
FAX: 508-854-0291

MICHIGAN
DETROIT
33782 STERLING PONDS BLVD.
STERLING HEIGHTS, MI 48312
PHONE: 586-978-9800
FAX: 586-978-9969

GRAND RAPIDS
668 3 MILE ROAD NW
GRAND RAPIDS, MI 49504
PHONE: 616-785-1784
FAX: 616-785-1788

MINNESOTA
MINNEAPOLIS
21080 134TH AVE. NORTH
ROGERS, MN 55374
PHONE: 763-428-3633
FAX: 763-428-4551

MISSOURI
ST LOUIS
422 INDUSTRIAL DRIVE
MARYLAND HEIGHTS, MO 63043
PHONE: 314-298-1800
FAX: 314-298-7660

KANSAS CITY
915 N W PLATTE VALLEY DR
RIVERSIDE, MO 64150
PHONE: 816-587-0272
FAX: 816-587-3735

NEW YORK
AUBURN
ONE ELLIS DRIVE
AUBURN, NY 13021
PHONE: 315-255-3403
FAX: 315-253-9923

NORTH CAROLINA
GREENSBORO
1220 ROTHERWOOD ROAD
GREENSBORO, NC 27406
P O BOX 16500
GREENSBORO, NC 27416
PHONE: 336-272-6104
FAX: 336-273-6628

OHIO
CINCINNATI
2929 CRESCENTVILLE ROAD
CINCINNATI, OH 45069
PHONE: 513-771-2600
FAX: 513-772-2219

CLEVELAND
8929 FREEWAY DRIVE
MACEDONIA, OH 44056
PHONE: 330-468-4777
FAX: 330-468-4778

OKLAHOMA
TULSA
2 EAST DAWES
BIXBY, OK 74008
PHONE: 918-366-9320
FAX: 918-366-9338

OREGON
PORTLAND
20393 SW AVERY COURT
TUALATIN, OR 97062
PHONE: 503-691-9010
FAX: 503-691-9012

PENNSYLVANIA
PHILADELPHIA
1035 THOMAS BUSCH
MEMORIAL HIGHWAY
PENNSAUKEN, NJ 08110
PHONE: 856-661-1442
FAX: 856-663-6363

PITTSBURGH
616H BEATTY ROAD
MONROEVILLE, PA 15146
PHONE: 412-380-7244
FAX: 412-380-7250

TENNESSEE
MEMPHIS
4000 WINCHESTER ROAD
MEMPHIS, TN 38118
PHONE: 901-365-2020
FAX: 901-365-3914

TEXAS
HOUSTON
4647 PINE TIMBERS
SUITE # 105
HOUSTON, TX 77041
PHONE: 713-895-7062
FAX: 713-690-4540

DALLAS
3040 QUEBEC
DALLAS, TX 75247
PHONE: 214-634-7271
FAX: 214-634-8874

UTAH
SALT LAKE CITY
2230 SOUTH MAIN STREET
SALT LAKE CITY, UT 84115
PHONE: 801-832-0127
FAX: 801-832-8911

WISCONSIN
MILWAUKEE
2725 SOUTH 163RD STREET
NEW BERLIN, WI 53151
PHONE: 262-784-5940
FAX: 262-784-1215

INTERNATIONAL SALES
FORT SMITH, AR
BALDOR ELECTRIC CO
FORT SMITH, AR 72902
PHONE: 479-646-4711
FAX: 479-648-5895

CANADA
EDMONTON, ALBERTA
4053-92 STREET
EDMONTON, ALBERTA T6E6R8
PHONE: 780-434-4900
FAX: 780-438-2600

OAKVILLE, ONTARIO
2750 COVENTRY ROAD
OAKVILLE, ONTARIO L6H6R1
PHONE: 905-829-3301
FAX: 905-829-3302

MONTREAL, QUEBEC
1844 WILLIAM STREET
MONTREAL, QUEBEC H3J1R5
PHONE: 514-933-2711
FAX: 514-933-8639

VANCOUVER,
BRITISH COLUMBIA
1538 KEBET WAY
PORT COQUITLAM, BC V3C 5M5
PHONE: 604-421-2822
FAX: 604-421-3113

WINNIPEG, MANITOBA
54 PRINCESS STREET
WINNIPEG, MANITOBA R3B1K2
PHONE: 204-942-5205
FAX: 204-956-4251

AUSTRALIA
UNIT 3, 6 STANTON ROAD
SEVEN HILLS, NSW 2147,
AUSTRALIA
PHONE: (61) (2) 9674 5455
FAX: (61) (2) 9674 2495

UNIT 8, 5 KELLETTS ROAD
ROWVILLE, VICTORIA, 3178
AUSTRALIA
PHONE: (03) 9753 4355
FAX: (03) 9753 4366

BALDOR CENTROAMERICA
BALDOR CENTROAMERICA
RESIDENCIAL PINARES DE SUIZA
POL. 15 #44, NVA. SAN SALVADOR
EL SALVADOR, CENTRO AMERICA
PHONE: (503) 288-1519
FAX: (503) 288-1518

PANAMA
BALDOR SUDAMERICA
9109 0818, ZONA 6 BETHANIA
PANAMA CITY, REP. DE PANAMA
PHONE: (507) 261-5347
FAX: (507) 261-5355

CHINA
SHANGHAI JIAHUA BUSINESS
CENTER
ROOM NO. C-203
808 HONG QIAO ROAD
SHANGHAI 200021
PHONE: 86-21-64473060
FAX: 86-21-64078620

GERMANY
DIESELSTRASSE 22
D-85551 KIRCHHEIM
MUNICH, GERMANY
PHONE: (49) (89) 90508 - 0
FAX: (49) (89) 90508 - 491

ITALY
Baldor ASR AG
Mendrisio Office
Via Borromini, 20A
6850 Mendrisio
Switzerland
PHONE: 0041 91 640 99 50
FAX: 0041 91 630 26 33

JAPAN
DIABLDG 802,
2-1-1 TSURUYA-CHO,
KANAGAWA-KU
YOKOHAMA, 221-0835, JAPAN
PHONE: 81-45-412-4506
FAX: 81-45-412-4507

KOREA
ROOM 210
BUPYEONG INDUSTRIAL
COMMERCIAL COOP.
396-13 CHEONGCHEON 2-DONG,
BUPYEONG-GU
INCHEON, KOREA, 403-858
PHONE: 82-32-508-3252
FAX: 82-32-508-3253

MÉXICO
BLVD. AL AEROPUERTO, KM. 2
LEON 37545, GUANAJUATO,
MÉXICO
PHONE: 52-477-761-2030
FAX: 52-477-761-2010

SINGAPORE
51 KAKI BUKIT ROAD 2
K B WAREHOUSE COMPLEX
SINGAPORE 417863
PHONE: (65) 6 744 2572
FAX: (65) 6 747 1708

SWITZERLAND
POSTFACH 73
SCHUTZENSTRASSE 59
CH-8245 FEUERTHALEN
SWITZERLAND
PHONE: (41) (52) 6474700
FAX: (41) (52) 6592394

TAIWAN
ROOM R, 2F, NO. 124
CHUNG CHENG ROAD, SHIHLIN
DIST.
TAIPEI 11141
PHONE: 886-2-2835-1666 EXT. 802
FAX: 886-2-2835-1717

UNITED KINGDOM
6 BRISTOL DISTRIBUTION PARK
HAWKLEY DRIVE
BRISTOL BS32 0BF U.K.
PHONE: 44 1454 850000
FAX: 44 1454 859001

BALDOR[®] **MOTORS AND DRIVES**

BALDOR ELECTRIC COMPANY
P.O. Box 2400
Fort Smith, AR 72902-2400
(479) 646-4711
Fax (479) 648-5792

CH TEL: +41 52 647 4700 FAX: +41 52 659 2394	D TEL: +49 89 90 50 80 FAX: +49 89 90 50 8491	UK TEL: +44 1454 850000 FAX: +44 1454 859001	F TEL: +33 145 10 7902 FAX: +33 145 09 0864
I TEL: +39 11 562 4440 FAX: +39 11 562 5660	AU TEL: +61 29674 5455 FAX: +61 29674 2495	CC TEL: +65 744 2572 FAX: +65 747 1708	MX TEL: +52 477 761 2030 FAX: +52 477 761 2010