

ADAP-KOOL®

AK2 Input - Output Modules
For AK2-SC255 and AKC 55 Systems-SC255

Table of Contents

Installing AK2 Modules.....	pp. 3-20
Introduction	p. 3
Communications	p. 3
Power supply.....	p. 3
Mounting modules	p. 4
DIN rail mounting	p. 4
Screw mounting	p. 4
Installing a communications module	pp. 4-5
Cabling requirements (TP78 in AKC 55 systems)	p. 4
Other transceiver types.....	p. 4
Addressing.....	p. 6
Network connections.....	p. 6
Power connection	p. 6
Installer’s final inspection	pp. 6-7
Error and status LEDs	p. 7
Installing an AK2-XM 204 digital output module	pp. 8-9
Connecting loads	p. 8
Installer’s final inspection	p. 8
Installing an AK2-XM 205A Combination Digital Output and Universal Analog Input Module	pp. 10-12
Digital outputs.....	p. 10
Universal analog inputs	p. 10
4-20 ma inputs.....	p. 10
Dry contact inputs	p. 11
Installers final inspection.....	p. 12
Installing an AK2-XM 101A Universal Analog Input Module	pp. 13-14
Universal analog inputs	p. 13
Compatible sensors.....	p. 13
4-20 ma inputs.....	p. 13
Dry contact inputs	p. 13
Installer’s final inspection	p. 14
Installing an AK2-XM 101A Low Voltage Digital Input Module	pp. 15-16
Explanation.....	p. 15
Installer’s final inspection and illustration.....	pp. 15-16
Installing an AK2-XM 101A High Voltage Digital Input Module.....	pp. 17-18
Explanation.....	p. 17
Installer’s final inspection and illustration.....	pp. 17-18
Installing an AK2-XM208B EEPR Stepper Motor Output Module	pp. 19-20
Configuring an AK2-XM208B EEPR Stepper Motor Output Module (special requirements)	pp. 21-24
Configuring AK2 I/O Modules in an AKC 55 System (important information for all modules)	p. 25
What’s different (Board & Point entries).....	p. 25
Specifications of AK2 Modules	pp. 26-31
AK2-CM 101A communications module.....	p. 26
AK2-XM 204A digital output module, AK2-XM 205A combination AI-DO module.....	p. 27
AK2-XM 101A Analog Input Module	p. 28
AK2-XM 102A low voltage digital input module	p. 29
AK2-XM 102B high voltage digital input module.....	p. 30
AK2-XM 208B bipolar stepper output module	p. 31
Code numbers (ordering) for AK2 modules	p. 32

Installing AK2 Modules

The AK2 series of I/O modules form lineups, with each lineup having a single user-addressed communications module and up to nine self-addressing I/O modules of any assortment. These lineups become groups of nodes in supermarket control and monitoring systems based on Danfoss AK2-SC 255 and AKC 55 Rack Controllers. The modules are physically linked by means of connectors at each end of each module. The connector holds the modules together and makes the electrical connections between them. All power and network connections are made through the module connectors, with only the communications module in each lineup having a power cable and a network cable to the system's I/O network.

Fuses

Each module has a black cover with an identification label. There are fuses in the communications modules and in modules that have digital outputs. The fuses are reached by removing the module cover. Except for the fuses, there are no user adjustments or user serviceable parts in the modules, and when modules are in service, the covers should always be in place.

The types of AK2 I/O modules are the following:

Module name	Description	Inputs and outputs provided	Power
AK2-CM 101A	communications module		
AK2-XM 204A	digital output module	8 relay outputs	3.0 W (3.7 VA)
AK2-XM 205A	universal analog input & digital output module	8 relay out, 8 universal inputs	3.9 W (4.8 VA)
AK2-XM 101A	universal input module	8 universal analog inputs	1.3 W (1.5 VA)
AK2-XM 102A	digital input module (low voltage)	8 digital inputs, 9-80Vac or Vdc	1 W (1.25 VA)
AK2-XM 102B	digital input module (high voltage)	8 digital inputs, 80-260Vac	0.8 W (1.0 VA)
AK2-XM 107A	pulse input module	8 pulse inputs	1 W (1.25 VA)
AK2-XM 208B	Bipolar stepper output module	4 bipolar stepper outputs	0.8 W (1.0 VA)

[Stepper module requires a second separate 24 Vac power source (Danfoss IOPS) for valve drive power. See installation section of this manual.]

AK2 module names contain information about their use and size. A module containing the letters "CM" is a communications module. One containing the letters "XM" is an extension module. The last grouping of 3 or 4 characters in the name specifies the exact type of module. The first digit of the last group indicates the width of the module: 1 for a half-width module and 2 for a full-width module. The remainder indicates the exact nature of the module.

Communications

The AK2-CM 101A communications module is available with 3 types of Echelon® transceiver: TP78, EIA 485, and FTT. The TP78 protocol is required for AK2-SC255 and AKC 55 systems. Each physically separate lineup of I/O modules requires a communications module.

In locating the communications module, remember that the total length of all cable runs from either type of **ADAP-KOOL**® Rack Controller, including stubs, is limited to 5000 feet.

Power supply

A single communications module will support up to 9 I/O modules.

Use only a galvanically isolated class 2 power supply. It is recommended that one of the 24 Vac Danfoss IOPS supplies be used, either the 30 VA or 56 VA version, depending on the total VA demand of the extension modules in the lineup. Part numbers for ordering IOPS power supplies are given on the last page of this manual. In selecting a power supply, be certain to check the total power requirements in VA using the table above.

When a Danfoss IOPS is used, it can be located up to 50 feet from the communications module it is powering.

Use 16 or 18 AWG wire when connecting power to the communications module.

Fuses Fuses are reached by removing the module cover. Except for the fuses, there are no user adjustments or user serviceable parts in the modules, and when modules are in service, the covers should always be in place.

Mounting modules All AK2 modules offer two mounting options: DIN rail mounting and screw mounting. All of the modules in a lineup must be mounted in the same way.

DIN rail mounting For DIN rail mounting, first mount the rail with a minimum of 2 1/4 inches clearance on each side. Open the first module's red tabs by using a small screwdriver as shown in the drawings below until the tabs snap open. Then position the module by slipping it over the rail, hold it in place, and press the red tabs. The module will be securely mounted.

To mount the second and subsequent modules on a DIN rail, open the red tabs as shown below. Position the new module so that the connectors are engaged, and gently push the module toward the rail until it is seated. Then press the red tabs to release them and lock the module in place.

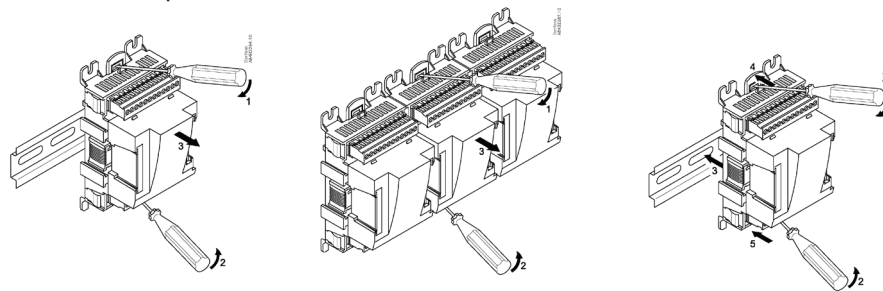

Screw mounting When mounting on a flat surface with screws, mount the communications module first, using the screw slots. Then connect the first extension module and secure it is advisable to connect the modules first, then position the entire lineup of modules and mark the screw holes. After drilling the holes, mount with panhead screws or bolts.

Installing a communications module

Cabling requirements A communications module has one of three types of transceiver (TP78, EIA 485, or FTT). The ADAP-KOOL® I/O network uses the TP78 protocol. **and communications modules with TP78 transceivers (code number 080Z0061) are required.** No other type of communications module will function in an ADAP-KOOL® network.

Use 20 to 24 AWG stranded twisted shielded, Belden 9841, 9464, 9461, 8762, 8761, or equivalent.

Place a terminator across the network terminals on the last communications module on any cable run from an ADAP-KOOL® Rack Controller.

Use the drawing on the facing page for reference while wiring your control system.

Other transceiver types

When Danfoss I/O is used with non-Danfoss systems, the communications module is available with two other transceiver types. Those types, and their cabling requirements, are:

FTT transceiver, Code number 080Z0062

Use 16 AWG stranded twisted, Belden 85102 or equivalent.

Do not use shielded cable with this transceiver.

EIA 485 transceiver, Code number 080Z0063

Use 20 to 24 AWG stranded twisted shielded, Belden 9841, 9464, 9461, 8762, 8761, or equivalent.

I/O POWER SUPPLY (IOPS)

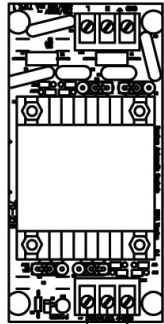

SET JUMPERS W3 & W4 FOR 24VAC OUTPUT

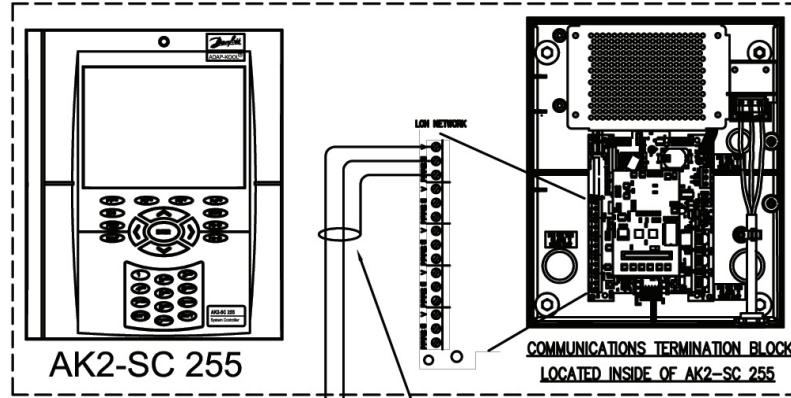

SHIELD CONNECTION: OBEERVE RULES FOR NETWORK TYPE

ECHOLON NETWORK: FOLLOW CABLE SPECIFICATIONS IN THE MANUAL

B } ECHOLON COMMUNICATIONS:
A } CONNECT TO NEXT NODE

GROUND } 24 VAC AND GROUND:
24 VAC } CONNECT TO NEXT NODE
24 VAC }

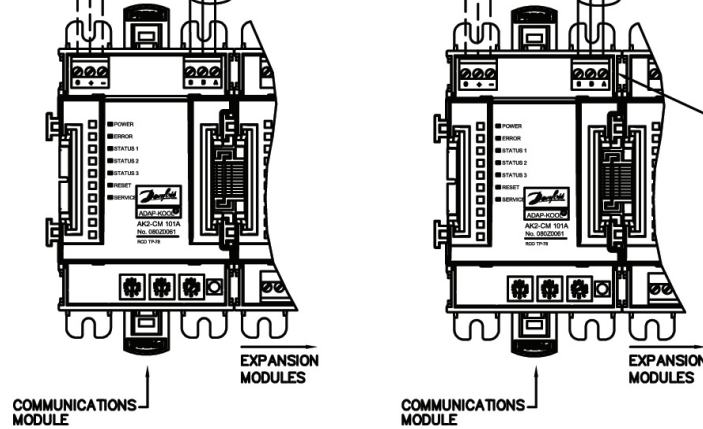

PLACE A NETWORK TERMINATOR AS SHOWN IF THIS COMMUNICATIONS MODULE IS THE LAST ONE ON THE NETWORK

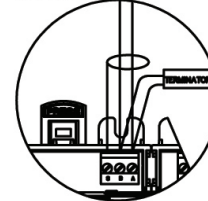

Make sure to follow all the steps in the instructions that follow.

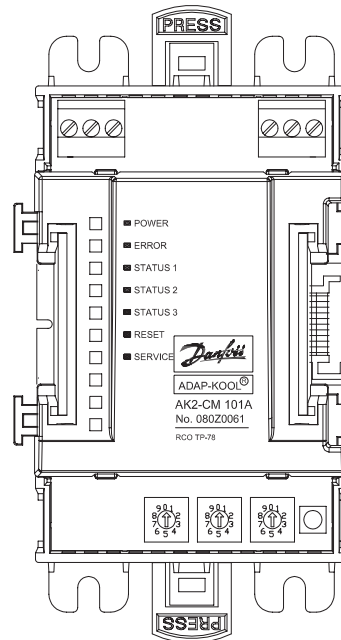

Addressing Using the rotary ID switches shown at lower right in the illustration, set the communication module's unique address (from 001-099). Any number can be used as long as it is not used on any other communication module in the system.

Network connection Using 20-24 AWG shielded stranded twisted pair cable, connect the communications module to one of the I/O network terminal blocks on the host Rack Controller. A communications module can also be connected in a "daisy chain" to the network terminals of another node on the Rack Controller's I/O network. There is no need to observe any particular polarity with the A and B wires when making network connections.

Connect the shield to the terminals marked "shield" at both ends of every TP78 communications cable.

If the communications module is the last unit on the cable run, place a network terminator across its A and B terminals. Network terminators are supplied with every Danfoss Rack Controller, across each set of "NETWORK" terminals. If you are rebuilding an I/O run, you should find a terminator across the A-B terminals of the last node on the network.

Power connection With main power to the communications module interrupted, connect the 24V terminals and ground of the power supply to the three corresponding terminals of the communications module. Make sure to use a supply with a VA rating adequate for the modules being connected. Module power ratings are given on page 3.

Wiring of the communications module is now complete.

Inspection of the installed Communication module When a communication module is ready for operation, you should be able to observe the following, proceeding clockwise around the module from the power terminal strip:

1. Power connections have been made.
2. Address switches have been set to a valid unique address from 001 to 099.
3. Connection has been made to an I/O network terminal of the Rack Controller at the "NETWORK" terminals, or to the network terminals of another node on the I/O

4. If this module is the last node on an I/O cable run, make sure that it is terminated by using one of the terminators supplied with the rack controller. The terminator should be placed across the A and B terminals at the network connection on the communication module.
5. If functioning is normal, the first five status LED states shown below under “**Error LED OFF**” will occur in order. The module will go through these states any time power is interrupted and reapplied.

Software configuration of I/O points is done from the rack controller or from a PC, and is covered in the section titled “Configuration.”

Error and Status LEDs The Error and Status LEDs indicate the following conditions when there is power to a communications module on the I/O network and a lineup of I/O modules is connected:

Error LED OFF	Status LEDs ON	Meaning	
	1	(briefly) Powering up.	
	2	Local bus initialized, waiting for host acknowledgement	
	3	Connection to host established. Receiving configuration.	
	1, 2, 3	(briefly) Communications module configured.	
Error LED blinking	1 blinking 2, 3 on	Running, all modules operational	
	1 blinking 2, 3 on	Running, one or more modules offline.	
Error LED ON	Status LEDs ON	Description	Possible cause
	1	Automatic address assignment failed.	No working modules found; Module limit exceeded
	2	Unable to retrieve self-identification record from one or more modules.	Software error in one or more I/O modules
	3	Upper memory buffer boundary exceeded.	Maximum number of input points (80) exceeded
	1, 2, 3	Host communication timeout	Host rack controller is offline

Every hour, the communications module performs a check with all the extension modules in its lineup. During this check (less than 1/4 second) the ERROR LED on the communications module will light. This is normal and does not indicate any malfunction.

Installing an AK2-XM 204 digital output module

The AK2-XM 204 digital output module provides 8 fused digital outputs; each output can be wired to normally open (NO) or normally closed (NC) relay contacts. This module is available with or without override switches, and can be supplied in three terminal block variations: (1) without terminal blocks; (2) with Phoenix-type terminal blocks; and (3) with Euromate-type terminal blocks. Electrical data is found in the specifications toward the end of this manual.

Fuses Fuses are reached by removing the module cover. Except for the fuses, there are no user adjustments or user serviceable parts in the modules, and when modules are in service, the covers should always be in place.

Mounting Mount the module by connecting it to a communications module or to an existing lineup. Mounting instructions are supplied with the module and are also given in the section of this manual about the communications module.

CAUTION **All safety precautions normally used when wiring control systems and high voltage equipment should be observed.**

Disconnect power from the communications module before wiring any extension modules in its lineup.

Connecting loads Observe the cautions stated above. Terminal blocks can be removed from the module for making connections.

Connections to the module are in groups of three as shown in the illustration. Each group has a C (common) screw numbered from 1 to 8, an NO (normally open) screw, and an NC (normally closed) screw. Wire each load to the module using a numbered group of 3 terminal screws. Connect each load to common and to either NO or NC contacts.

Recording digital output information

For each digital output module, record the unique two-digit address of the lineup's communication module, the single digit location of the I/O module (1 for the module next to the communication module, 2 for the next one, and so on up to 9), and the terminal number (point number) to which the controlled load is wired. Also record a description of the point wired to the terminal (e.g. "compressor A1"). A form is provided with each new I/O module for this purpose. *You will need this information when configuring the host controller.*

When all connections are made, and after replacing the terminal block if necessary, reconnect power to the communications module.

Inspection of the installed digital output module

When a digital output module is ready for operation, you should be able to observe the following:

1. The module is securely mounted to DIN rail or to a flat surface.
2. The module is connected to a communication module, or to an existing lineup
3. Power has been reconnected to the communication module.
4. The POWER LED is ON.
5. The COMM ERROR LED is OFF.
6. The status LEDs are ON for each point whose output relay is energized, and OFF for each point whose output relay is de-energized.
7. The override LEDs reflect the status of the override switches. The LED should be OFF for each switch in the center AUTO position. The LED should be ON for each switch in the left (OFF) or right (ON) position.

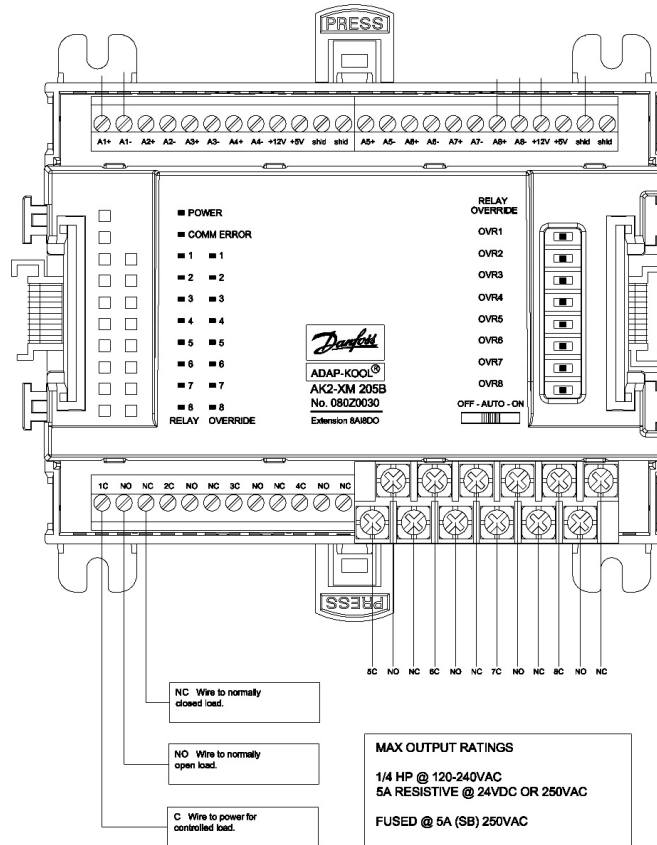

Status LEDs, relay states, and override switches

There are eight status LEDs, one for each output point. A status LED represents the state of the point's relay, and not necessarily the state of the device wired to that point. If the LED is ON, the relay is energized. With the LED ON, then, a device wired through normally closed (NC) contacts is OFF, because the normally closed contacts are open.

Refrigeration compressors, for example, are wired through normally closed (NC) contacts so that if power to the control system fails, and all the relays are de-energized, the control circuits for the compressors will be closed, and the compressors will run.

Override switches have logic in line with that of the status LEDs. When an override switch is put in the ON position, the corresponding relay is continuously energized; the LED will come ON; and any device wired through the normally closed (NC) contacts is forced OFF. If the same point were to have a device wired through its normally open (NO) contacts instead, the LED would be ON and the device forced ON.

When an override switch is put in the OFF position, the corresponding relay is continuously de-energized; the LED will be OFF; and any device wired through the normally closed (NC) contacts is forced ON. If the same point were to have a device wired through its normally open (NO) contacts instead, the LED would be OFF and the device forced OFF.

Installing an AK2-XM 205A Combination Digital Output and Universal Analog Input Module

The AK2-XM 205A combination digital output and analog input module provides 8 fused digital outputs and 8 universal analog inputs. Each output load can be wired through normally open (NO) or normally closed (NC) relay contacts. This module is available with or without override switches and with two types of terminals, both of which can be seen in the illustration that follows. Excitation voltages for inputs are furnished at +5V and +12V.

Mounting Mount the module by connecting it to a communications module or to an existing lineup. Mounting instructions are supplied with the module and are also given in the section of this manual about the communications module.

CAUTION **All safety precautions normally used when wiring control systems and high voltage equipment should be observed.**

Disconnect power from the communications module before wiring any extension modules in its lineup.

Digital outputs

Connecting loads Loads are connected as described in the previous section for digital output modules. Connections to the module are in groups of three as shown in the illustration. Each group has a C (common) screw numbered from 1 to 8, an NO (normally open) screw, and an NC (normally closed) screw. Wire each load to be controlled to the module using a numbered group of 3 terminal screws. Connect each load to common and to either NO or NC contacts.

Recording digital input information For each digital output on the combination module, record the unique two-digit address of the lineup's communication cation module, the single digit location of the I/O module (1 for the module next to the communication module, 2 for the next one, and so on up to 9), and the terminal number (point number) to which the controlled load is wired. Also record a description of the point wired to the terminal (e.g. "compressor A1"). A form is provided with each new I/O module for this purpose. You will need this information when configuring the host controller.

Universal analog inputs The module's 8 analog inputs connect to the terminals opposite the relay output terminals. Each input can be either an analog or a dry contact digital input. High and low voltage input modules are separately available for sensing the presence or absence of current flows (e.g. compressor contactors).

Compatible sensors Sensor types that can be used with this module are the same as for the AK2-XM 101A analog input module, and will be found in the next section, which covers that module.

Connecting analog inputs Connect analog inputs as shown on the facing page. Resistive sensors with two wires are connected like the temperature sensor shown at left, and sensors requiring an excitation voltage are connected like the pressure transducer shown at right.

4-20mA inputs When connecting a sensor with a 4-20 mA output, place a 250 Ohm 1/4 Watt precision resistor across the input terminals to be used.

Recording sensor information

For each analog on the combination module, record the unique two-digit address of the lineup's communication module, the single digit location of the I/O module (1 for the module next to the communication module, 2 for the next one, and so on up to 9), and the terminal number (point number) to which the sensor is wired. Also record a description of the sensor wired to the terminal (e.g. "suction pressure compressor A1"). A form is provided on the reverse side of the form for the digital outputs for this purpose. You will need this information when configuring the host controller.

Inspection of the installed combination module

When a combination module is ready for operation, you should be able to observe the following:

1. The module is securely mounted to DIN rail or to a flat surface.
2. The module is connected to a communication module, or to an existing lineup
3. Power has been reconnected to the communication module.
4. The POWER LED is ON.
5. The COMM ERROR LED is OFF.
6. The status LEDs reflect the status of the output relays. The LED should be lit for each point whose relay is energized.
7. The override LEDs reflect the status of the override switches. The LED should be OFF for each switch in the center AUTO position. The LED should be ON for each switch in the left OFF) or right (ON) position.

Installing an AK2-XM 101A Universal Analog Input Module

The AK2-XM 101A half-width analog input module provides 8 analog inputs for sensors and dry contact digital inputs. Excitation voltages for inputs are furnished at +5V and +12V.

Mounting Mount the module by connecting it to a communications module or to an existing lineup. Mounting instructions are supplied with the module and are also given in the section of this manual about the communications module.

CAUTION **All safety precautions normally used when wiring control systems and high voltage equipment should be observed. Disconnect power from the communications module before wiring any extension modules in its lineup.**

Universal Analog inputs The module's 8 analog inputs connect to the terminals on the top and bottom of the module enclosure. Each input can be either an analog or a dry contact digital input. High and low voltage input modules are separately available for sensing the presence or absence of current flows (e.g. compressor contactors).

Compatible sensors The following types of sensors can be connected to the module:

Sensor name	Sensor type	Sensor range	Remarks
AKS 11	Temperature sensor	-58 to 212°F	
AKS 12	Temperature sensor	-94 to 320°F	
AKS 21	Temperature sensor	-70 to 356°F	
THERM 3	Temperature sensor		requires VR5-1 interface board
DPS100	Dewpoint sensor	0 to 100°F	
AKS 32-100	Pressure transducer	0-100 psig	
AKS 32-200	Pressure transducer	0-200 psig	
AKS 32-500	Pressure transducer	0-500 psig	
CT 12, CT 13	Current transducer	0-25, 0-50, or 0-75 A	
CT 14, CT 15	Current transducer	0-100, 0-150, or 0-200 A	
EMHS3	Humidity sensor with AKS 11 temperature sensor	10-95% RH 32 to 120°F	
PHOTO-OD-1	Indoor-outdoor photo sensor	0 to 300 foot-candles	
ComTrol CTTS	Temperature sensor		requires CTP-KIT
ECI TP-1	Temperature sensor	-30 to 97°F	requires TP1-KIT
ECI TP-2	Temperature sensor	-30 to 97°F	requires CTP-KIT
CPC 501-1121	Temperature sensor		requires CTP-KIT

Connecting analog inputs Connect analog inputs as shown on the facing page. Resistive sensors with two wires are connected like the temperature sensor shown at left, and sensors requiring an excitation voltage are connected like the pressure transducer shown at right.

4-20mA inputs When connecting a sensor with a 4-20mA output, place a 250 ohm 1/4 watt precision resistor across the input terminals to be used.

Shielded cable When sensor cables have a required shield, connect the shield to one of the two terminals labeled "SHLD" at the end of each half of the terminal strip.

Dry contact inputs Connect one side of a dry contact digital input pair to one of the terminals labeled "A+ (A1+, A2+, etc.) and connect the other to one of the A- (A1-, A2-, etc.) terminals for excitation. Remember to record that the input is a "DI" rather than an "AI." This information will be

Recording sensor information

important when configuring the input at the host controller. For each set of terminals on the universal analog input module, record the unique two-digit address of the lineup's communication module, the single digit location of the I/O module (1 for the module next to the communication module, 2 for the next one, and so on up to 9), and the terminal number (point number) to which the sensor is wired. Also record a description of the sensor (e.g. "suction pressure compressor A1"). A form is provided with each new module for this purpose. You will need this information when configuring the host controller.

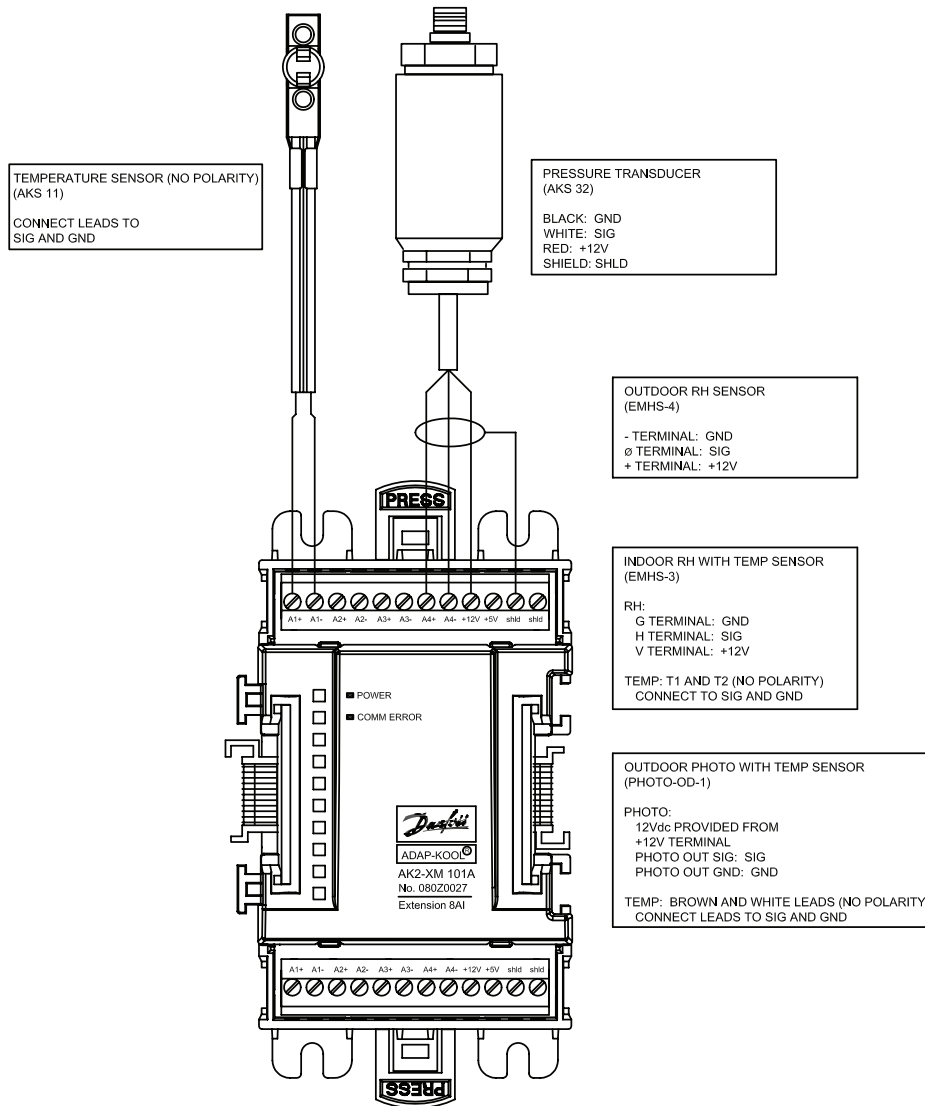

Inspection of the installed universal analog input module

When a universal analog input module is ready for operation, you should be able to observe the following:

1. The module is securely mounted to DIN rail or to a flat surface.
2. The module is connected to a communication module, or to an existing lineup
3. Power has been reconnected to the communication module.
4. The POWER LED is ON.
5. The COMM ERROR LED is OFF.

Installing an AK2-XM 102A Low Voltage Digital Input Module

Illustration of the module is on the next page.

The AK2-XM 102A half-width low voltage digital input module provides 8 digital inputs rated at 9 to 80V AC or DC.

Mounting

Mount the module by connecting it to a communications module or to an existing lineup. Mounting instructions are supplied with the module and are also given in the section of this manual about the communications module.

CAUTION

All safety precautions normally used when wiring control systems and high voltage equipment should be observed.

Disconnect power from the communications module before wiring any extension modules in its lineup.

Digital inputs

The module's 8 digital inputs connect to the terminals at the top and bottom of the module enclosure.

Connecting digital inputs

Connect digital inputs as shown on the facing page.

Recording input information

For each set of terminals on the digital input module, record the unique two-digit address of the lineup's communication module, the single digit location of the I/O module (1 for the module next to the communication module, 2 for the next one, and so on up to 9), and the terminal number (point number) to which the input is wired. Also record a description of the input wired to the terminal (e.g. "oil fail A1"). A form is provided with each new module for this purpose. *You will need this information when configuring the host controller.*

Inspection of the installed low voltage digital

input module

When a low voltage digital input module is ready for operation, you should be able to observe the following:

1. The module is securely mounted to DIN rail or to a flat surface.
2. The module is connected to a communication module, or to an existing lineup
3. Power has been reconnected to the communication module.
4. The POWER LED is ON.
5. The COMM ERROR LED is OFF.
6. The status LEDs 1 through 8 correctly reflect the operating status of the equipment being monitored.

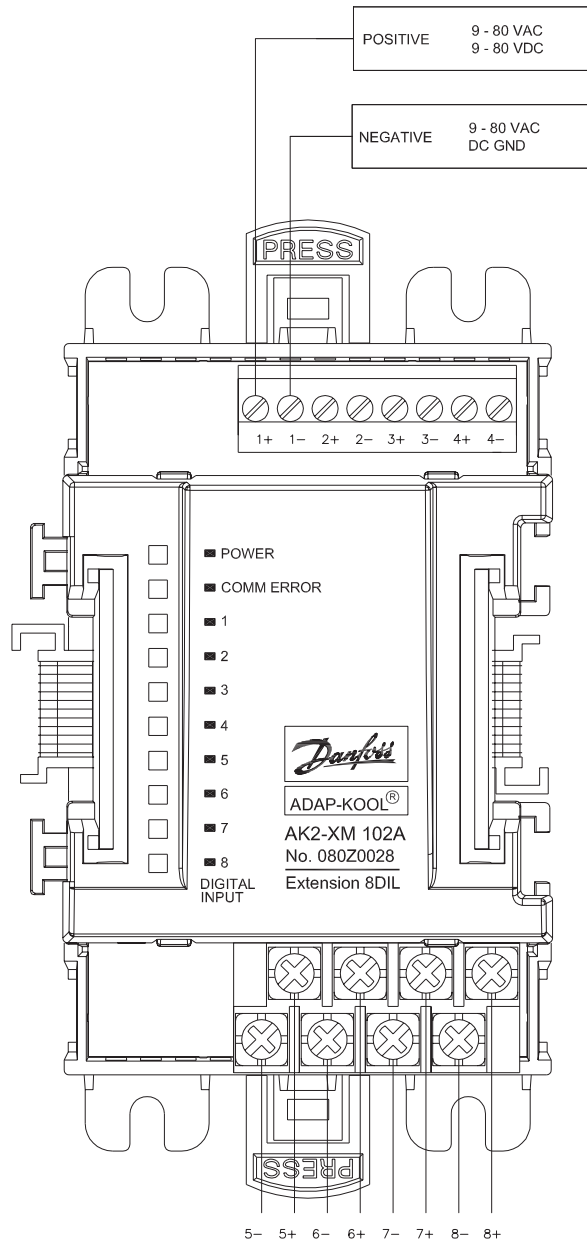

Installing an AK2-XM 102A High Voltage Digital Input Module

The AK2-XM 102A half-width high voltage digital input module provides 8 digital inputs rated at 80 to 260V AC.

Mounting Mount the module by connecting it to a communications module or to an existing lineup. Mounting instructions are supplied with the module and are also given in the section of this manual about the communications module.

CAUTION **All safety precautions normally used when wiring control systems and high voltage equipment should be observed.**

Disconnect power from the communications module before wiring any extension modules in its lineup.

Digital inputs The module's 8 digital inputs connect to the terminals on the top and bottom of the module enclosure.

Connecting Digital inputs Connect digital inputs as shown on the facing page.

Recording input information For each set of terminals on the digital input module, record the unique two-digit address of the lineup's communication module, the single digit location of the I/O module (1 for the module next to the communication module, 2 for the next one, and so on up to 9), and the terminal number (point number) to which the input is wired. Also record a description of the input wired to the terminal (e.g. "compressor A1"). A form is provided with each new module for this purpose. *You will need this information when configuring the host controller.*

Inspection of the installed

Low voltage digital input module When a high voltage digital input module is ready for operation, you should be able to observe the following:

1. The module is securely mounted to DIN rail or to a flat surface.
2. Connection has been made to a communication module or to another module that is already connected to a communication module.
3. Power has been reconnected to the communication module.
4. The POWER LED is ON.
5. The COMM ERROR LED is OFF.
6. The status LEDs 1 through 8 correctly reflect the operating status of the equipment being monitored.

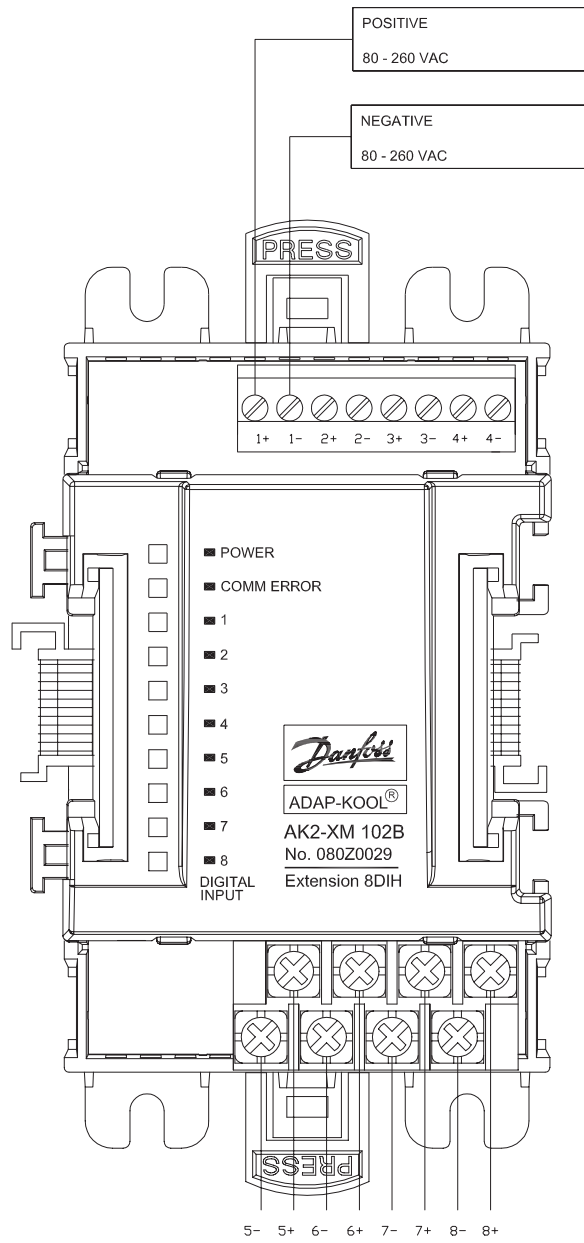

Installing an AK2-XM 208B EEPR stepper motor output module

The AK2-XM 208B EEPR stepper motor output module provides 4 bipolar outputs for control of stepper motor EEPR valves supplied by Danfoss and certain other manufacturers (see table below). This module is compatible with Danfoss AK2-SC 255 and AKC 55 system controllers.

The AK2-XM 208B EEPR stepper motor output module can be supplied in two: (1) without terminal blocks; (2) with Phoenix-type terminal blocks. Electrical data is found in the specifications toward the end of this manual.

Compatible valves

The AK2-XM 208B output module is compatible with the following stepper motor EEPR valves:

Danfoss	Alco	Sporlan
KVS 15-22	ESR 12 (12V)	CDS-8 (12V)
KVS 28-35	ESR 12 (24V)	CDS9 (12V)
KVS 42-54	ESR 20 (12V)	CDS 16/17 (12V)
	ESR 20 (24V)	

Disconnect power from the lineup

Before installing any new module, disconnect power from the lineup's communication module. Do not reconnect power until by following these instructions, the installation, including the final inspection, has been completed.

Mounting

Mount the AK2-XM 208B module by connecting it to a communications module or to an existing lineup. Mounting instructions are supplied with the module and are also given in the earlier section of this manual about the communications module.

CAUTION

All safety precautions normally used when wiring control systems and high voltage equipment should be observed.

Disconnect power from the communications module before wiring any extension modules in its lineup.

Connecting leads from EEPR valves

Observe the cautions stated above. There are connectors for four valves on each module. Terminal blocks can be removed for making easy connection of wire leads from valves.

Each compatible EEPR valve has four leads: red, white, black, and either green or blue. Remove the terminal block from an unused valve position on the module. Connect the valve leads to the terminal block in accordance with the wiring diagram on page 21. If no KVS cable filter is installed, make sure that no valve is more than 30 feet from the module. With a KVS cable filter installed, valves can be up to 100 feet (30 meters) from the AK2-XM208B module. Mount the filter module within one foot of the AK2-XM208B.

Recording board and point information

For each EEPR control module, record the unique two-digit address of the lineup's communication module, the single digit location of the EEPR module (1 for the module next to the communication module, 2 for the next one, and so on up to 9), and the terminal number (point number) to which each EEPR valve's leads are wired. Also record a description of the valve wired to the terminal (e.g. "circuit B-4" or "meat cases system 22). You will need this information when configuring the host controller for the new valve(s).

Connecting valve power

Power to operate controlled EEPR stepper motors is provided through the AK2-XM 208B. Connect 24V AC from a separate external Danfoss IOPS power supply to the power terminals on the AK2-XM 208B module. An external IOPS (56 VA) can supply up to 16 valves (using 4 AK2-XM 208B modules). Set the output of the power supply according to valve chart.

Reconnect power to the communications module

When all connections are made, and after replacing the module terminal blocks if necessary, reconnect power to the communications module. The AK2-XM 208B is now ready to configure.

Inspection of the installed digital output module

When physical installation of an AK2-XM 208B stepper EEPR control module is complete, you should be able to observe the following:

1. The module is securely mounted to DIN rail or to a flat surface.
2. The module is connected to a communication module, or to an existing lineup
3. Power has been reconnected to the communication module.
4. The POWER LED is ON.
5. The COMM LED is off. (It may blink initially until communication with the host controller is established. If steady on, seek support from Danfoss.)
6. The status LEDs should remain are ON for each point whose output relay is energized, and OFF for each point whose output relay is de-energized.

12 or 24V
(Valve Dependent)
See Chart

OUTPUT VOLTAGE SELECT
SET JUMPERS W3 & W4
FOR 12 OR 24 VOLTS
SEE DETAIL BELOW



SUPPLY VOLTAGE SELECT
SET JUMPERS W1 & W2
FOR 115 OR 230 VOLTS
SEE DETAIL BELOW



Unit shipped for 230 VAC supply.

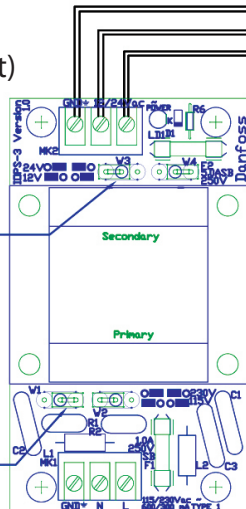

Class 1 Wiring

I/O Power Supply
56VA
Part No. 080Z0052

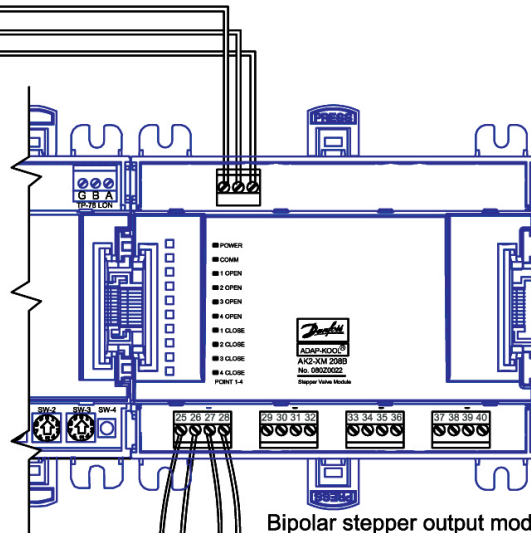

Bipolar stepper output module
AK2-XM 208B, Part No. 080Z0022

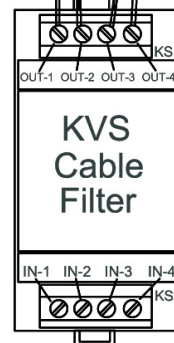

Part # 084B2238

Wiring Reference Chart

		Terminal #			
Valve	1	25	26	27	28
	2	29	30	31	32
	3	33	34	35	36
	4	37	38	39	40
KVS 15-34		White	Black	Red	Green
KVS 42-54		White	Black	Green	Red
Sporlan CDS		White	Black	Red	Green
Alco ESR		White	Black	Red	Blue

Configuring a Danfoss controller for an AK2-XM 208A EEPR stepper motor output module

After installation of the hardware, host controller software must be configured for the type of valve to be controlled and for operational settings. Use the procedure that follows.

From the controller's Main Menu, select "Configuration."

From the Configuration Menu, select "Refrigeration."

From the Refrigeration Menu, select the rack with the EEPR valve you want to configure.

From the Configure Rack Menu, select the suction group. The Evaporator configuration screen will appear.

[note: There may be many evaporators. For the purposes of this explanation, we have created a suction group with a single circuit.]

The Evaporator configuration screen appears at left below. EEPR configuration is an option under circuit type "AK2-SC255," so leave that field as is and select ">Setup<". The screen at right will appear, except that the cursor will be on the "Fixture Type" field..

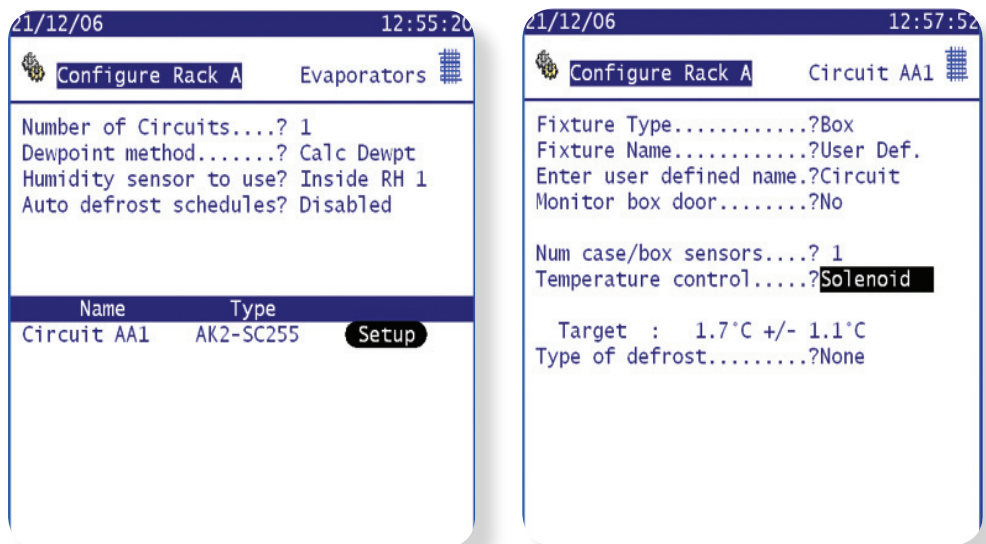

Configure the fixture and sensor information as for any other circuit (using the procedures given in chapter 1 of the AK2-SC 255 Rack Controller System Reference Manual). Then move the cursor to the "Temperature control" field and press ENTER (or left click). A list box will open as shown at left below. Move the cursor in the list box to "EEPR" and press ENTER (or left click).The screen will appear as at right below.

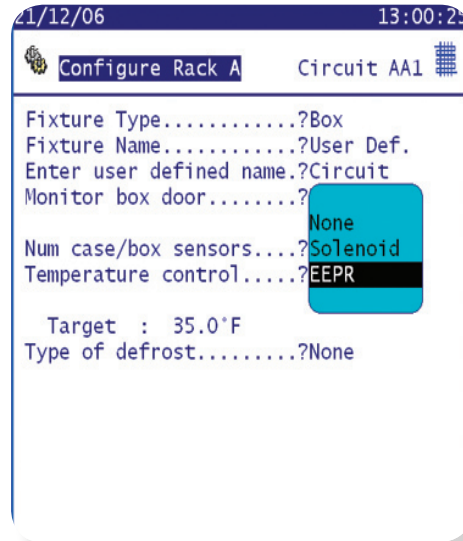

Notice that once EEPR is selected, the following “Target” line no longer shows a “+/-” value (often called a range or dead band), since no dead band is required for a modulating valve like a stepper EEPR. Enter the target temperature.

Page down to the next page and specify defrost if any. If there is an entry other than “None,” you will have to select a condition (Open, Closed) for the valve during defrost.

Board & Points Configuration

Return to the configuration menu, select Board & Points, and choose the icon for variable outputs. It is the fourth from left of the icons at the bottom of the screen. The screen that appears looks like the one at left below. Enter the board & point information (module address). In the sample screen, the address is 01-1.1. Yours will very likely be different.

Now select >Setup< and press ENTER, and the screen at right below will appear.

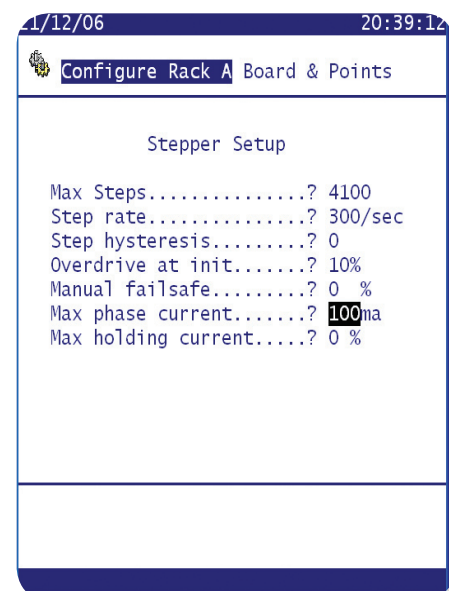
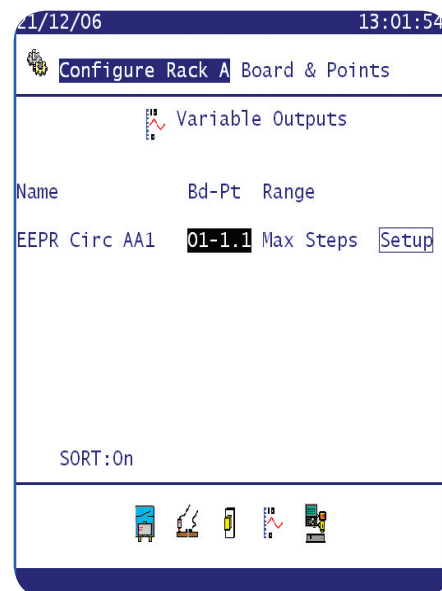

The settings in the “Stepper Setup” screen are determined by the type of valve that is being configured, and are given in the following table. “Manual failsafe” is explained in the text following the table. The sample has most of the data for a Danfoss KVS 42 or 54, taken from the table. The table also contains information for other manufacturers’ valves.

Valve Type	Max steps	Step rate	Step Hyster-esis	Overdrive at init	Max phase Current	Max holding current	Power Supply Voltage
Danfoss KVS 15 & 22	4100	300/sec	10	10%	100mA	0	24v
Danfoss KVS 28 & 35	5540	300/sec	10	10%	100mA	0	24v
Danfoss KVS 42 & 54	3810	150/sec	10	10%	100mA	0	24v
Alco ESR 12 (12v)	500 or 800**	50/sec	0	10%	410mA	0	12v
Alco ESR 12 (24v)	501 or 800**	50/sec	0	10%	210mA	0	24v
Alco ESR 20 (12v)	800	50/sec	0	10%	410mA	0	12v
Alco ESR 20 (24v)	800	50/sec	0	10%	210mA	0	24v
For Alco valves, the Max steps value depends on the date code of the individual valve. Valves manu- factured before 2001 have max 500 steps. Also consult Alco technical documentation for details							
Sporlan CDS 8	3064	150 sec	10	10%	215 mA	0	12v
Sporlan CDS 9	6386	150 sec	10	10%	215 mA	0	12v
Sporlan CDS 16/17	6386	150 sec	10	10%	215 mA	0	12v

Manufacturers may change valve specifications without notice. Always check the settings in the following table against information provided with each new valve by its manufacturer, or contact the manufacturer's application Engineering department for the information.

The fields in the EEPR Setup screen are as follows:

- Max steps (0 to 10000) The number of steps that corresponds with 100% opening of the valve.
- Step rate (0 to 500/sec) The rate at which the valve motor must be driven.
- Step hysteresis (0 to 127) When a gear-driven valve is at any given position, driving a number of steps to a new position, reversing direction, and then driving back the same number of steps, the valve may not return to the position it started from. This phenomenon occurs because of backlash in the gear train. To compensate, hysteresis is programmed, and works like this: When a valve is driven open to a target position, the controller will over-drive the valve by the hysteresis amount, then drive back in the closing direction by the same hysteresis amount. The effect is that regardless of the net change in valve position (either more open or more closed), the last real direction for valve travel will also be in the closed direction. The hysteresis adjustment ensures that the valve train is always pre-loaded in the same direction, ensuring repeatability of valve position.
- Overdrive at init (0 to 31%) Stepper motor valves do not usually include a feedback mechanism to determine the actual mechanical position of the valve. Valve manufacturers, however, design their valves to be overdriven at complete closure without damage. The "Overdrive at init" value gives the additional amount, as a percentage of "Max steps," that the valve should be driven closed whenever we initialize the valve. Valve initialization occurs automatically whenever the Rack Controller is reset, whenever the AK2-XM 208B stepper motor EEPR control module is reset, and whenever the associated refrigeration circuit defrosts.

Manual failsafe	(0 to 100%) Determines the position, as a percentage of full open, that the valve will default to should communications fail between the Rack Controller and the communications module for the AK2-XM 208B's lineup, or between the communications module and the AK2-XM 208B.
Max phase current	(0 to 1000 mA) Limits the current, and thus the power dissipation in the valve. Take care to set the value to the valve manufacturer's specification. The module resolves the programmed value to the nearest 10 mA.
Max holding current	(0 to 70%) The percentage of "Max phase current" required by some stepper valves to hold the valve at its most-recently-achieved position. The module resolves the programmed value to the nearest 10%.
Valve in defrost	(List box: Closed, Open) the position the valve should maintain during defrost.
Configuration	The AK2-XM 208A requires Board & Points configuration as an analog output board in accordance with the information in the following section under "What's different."

Configuring other AK2 I/O Modules in an AK2-SC 255 or AKC 55 System

Configuration of points on AK2 modules is almost exactly the same as for other points in systems based on an ADAP-KOOL Rack Controller. Consult the Rack Controller's User Manual or Reference Manual.

What's different

There is one difference in configuration. When entering the board and point information for an AK2 point, there are five characters to enter. That is why you recorded, for each point:

- the communications module address: (2 digits) from 01 to 99 (the leftmost switch is not used, and remains set to zero).
- the I/O module position: (1 digit) from 1 to 9
- the point number: (1 digits) from 1 to 8 (note that on combination modules, there are two sets of points, digital outputs and universal analog inputs, each set numbered from 1 to 8 (one set is entered in the digital output board & point screen, and the other in the sensor input board & point screen).

Name	Bcast	Bd-Pt	Type
Inside Temp	No	01-1.1	PT1000
Disch Press C	No	02-1.1	AKS32-500
Dropleg Temp C	No	02-1.2	PT1000
Inlet Temp C	No	02-1.3	PT1000
Suction Temp CA	No	02-1.4	PT1000
Suction Pres CA	No	02-1.5	AKS32-200
Oil Press CA1	No	02-1.6	AKS32-200
Outside Temp	No	02-1.7	PT1000

SORT: On "PG DN" for more

To make an entry in the board & point screen, you will need the address information you recorded while installing the individual I/O modules.

On the Board & Points screen, enter (for each point) the two-digit communications module address first. A hyphen automatically appears. Then, enter the single-digit position number for the extension module, then the two-digit point number. The point number can be entered as "01" or as ".1" but the entry will always display as in the screen shown above.

Either three character configuration or four character board & point numbers will be accepted by the Rack Controller, because traditional IO boards require three-character addresses as detailed in chapter 4 of your User Manual or Reference Manual, and AK2 points require the four-character addresses described here. If any other number of characters is entered, the entry will be rejected and zeros will appear.

Specifications – AK2-CM 101A communications module

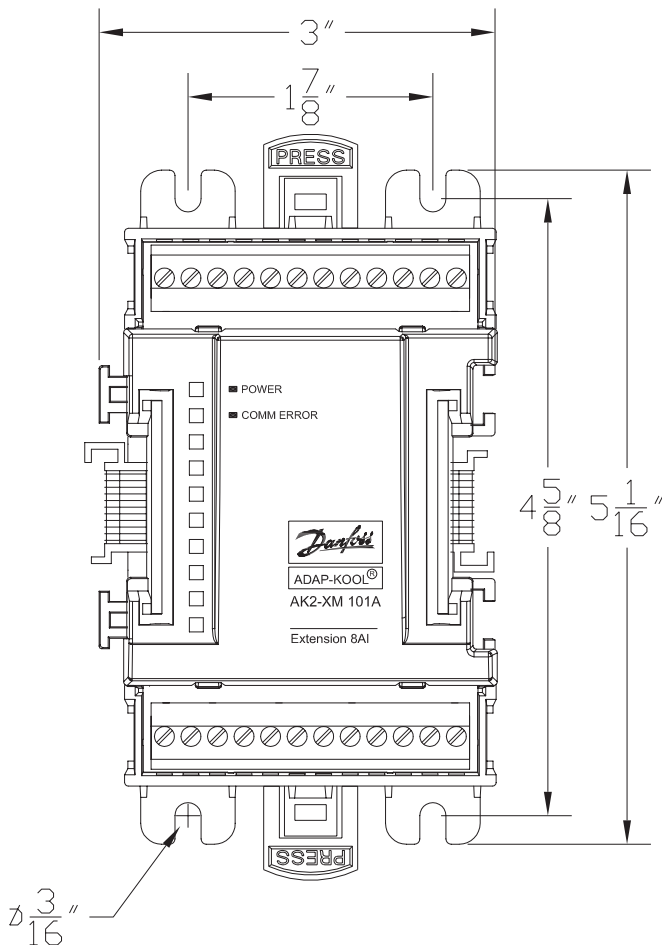

UL file number	E166834
Input voltage:	18-36 VDC, 24 VAC \pm 20%
Input power:	50 W (60 VA)
Input fusing:	3.15 A (SB) 250 VAC
Output voltage:	18-36 VDC
Output power capacity	up to 45 W
IO module capacity:	up to 10
Power consumption:	0.8 W @ 24 VDC 1.0 VA @ 24 VDC

Operating temperature:
-4 °F to 131°F @ 0 to 95% RH (non-condensing)

Storage Temperature:
-40°F to 158°F @ 0 to 95% RH (non-condensing)

Compatible with 24V battery backup systems.

Specifications – AK2-XM 204A digital output module AK2-XM 205A combination digital output & analog input module

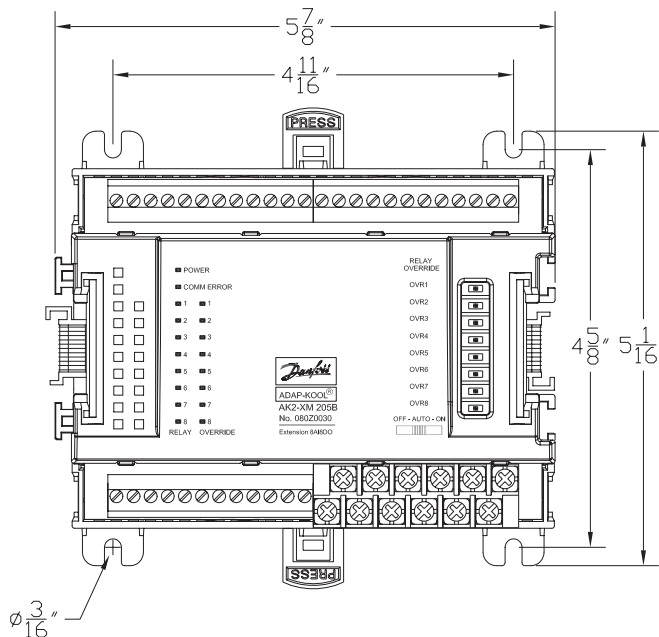

UL file number	E166834
General purpose relays:	8, form C
Universal inputs:	8
Relay rating:	1/4 hp 120-240 VAC 5 A resistive 24 Vdc or 240VAC
Device limit, outputs:	20A
Relay fusing:	5A, 250 VAC
Sensor excitation	5 or 12 VDC @ 100 mA
Excitation fusing	auto-reset, 200 mA
Power supply	18-36 VDC, 3.6W supplied by communications module
Power required to communications module:	3.9W @ 24 VDC 4.8 VA @ 24 VAC

Operating temperature:	-4 °F to 131°F (-20 to +55°C) @ 0 to 95% RH (non-condensing)
Storage Temperature:	-40°F to 158°F (-40 to +70°C) @ 0 to 95% RH (non-condensing)

Universal Inputs:	
(a) Voltage	
Resolution	1 mV
Accuracy @ 20°C	±4 mV @ 0-4 VDC
Temp. Coeff.:	±0.4 mV/°C
Accuracy @ 20 °C	±10 mV @ 4-10 VDC
Temp. Coeff.:	±1.4 mV/°C
(b) Resistive	
Resolution	±0.1Ω
Accuracy	±1.2Ω @ 10-400Ω ±0.4Ω @ 400-1500Ω ±1.2Ω @ 1500-2300Ω ±2.0Ω @ 2300-2500Ω
Temp. Coeff.:	±0.02Ω/°C, 10-1500Ω ±0.04Ω/°C, 1500-2300Ω
(c) Dry contact	
Contact cleansing current	120 mA for 0.1 msec.
Steady state current	10 mA
	Closed when contact resistance < 200Ω
(d) Ratiometric sensor	

Specifications – AK2-XM 101A analog input module

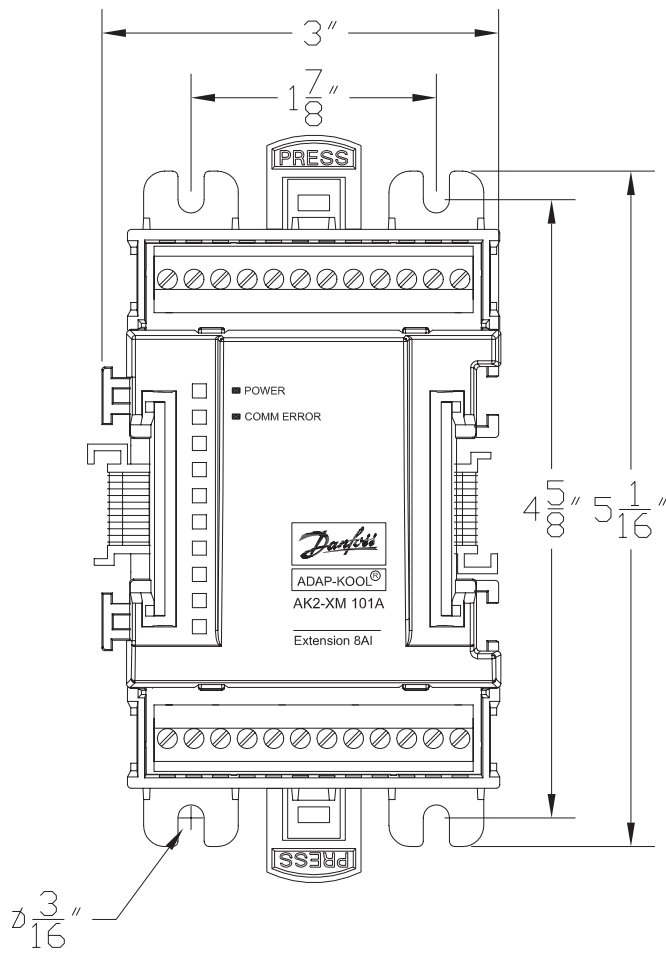

UL file number E166834
 Universal inputs: 8
 Sensor excitation 5 or 12 VDC @ 100 mA
 Excitation fusing auto-reset, 200 mA
 Power supply 18-36 VDC, 1.1W supplied by communication module

Power required to communication module:
 1.3W @ 24 VDC
 1.5 VA @ 24 VAC

Operating temperature:
 -4 °F to 131°F (-20 to +55°C)
 @ 0 to 95% RH (non-condensing)

Storage Temperature:
 -40°F to 158°F (-40 to +70°C)
 @ 0 to 95% RH (non-condensing)

Universal Inputs:

(a) Voltage

Resolution 1 mV
 Accuracy @ 20°C ±4 mV @ 0-4 VDC
 Temp. Coeff.: ±0.4 mV/°C
 Accuracy @ 20 °C ±10 mV @ 4-10 VDC
 Temp. Coeff.: ±1.4 mV/°C

(b) Resistive

Resolution ±0.1Ω
 Accuracy ±1.2Ω @ 10-400Ω
 ±0.4Ω @ 400-1500Ω
 ±1.2Ω @ 1500-2300Ω
 ±2.0Ω @ 2300-2500Ω
 Temp. Coeff: ±0.02Ω/°C, 10-1500Ω
 ±0.04Ω/°C, 1500-2300Ω

(c) Dry contact

Contact cleansing current 120 mA for 0.1 msec.
 Steady state current 10 mA
 Closed when contact resistance < 200 Ω

(d) Ratiometric sensor

Specifications – AK2-XM 102A digital input module (low voltage)

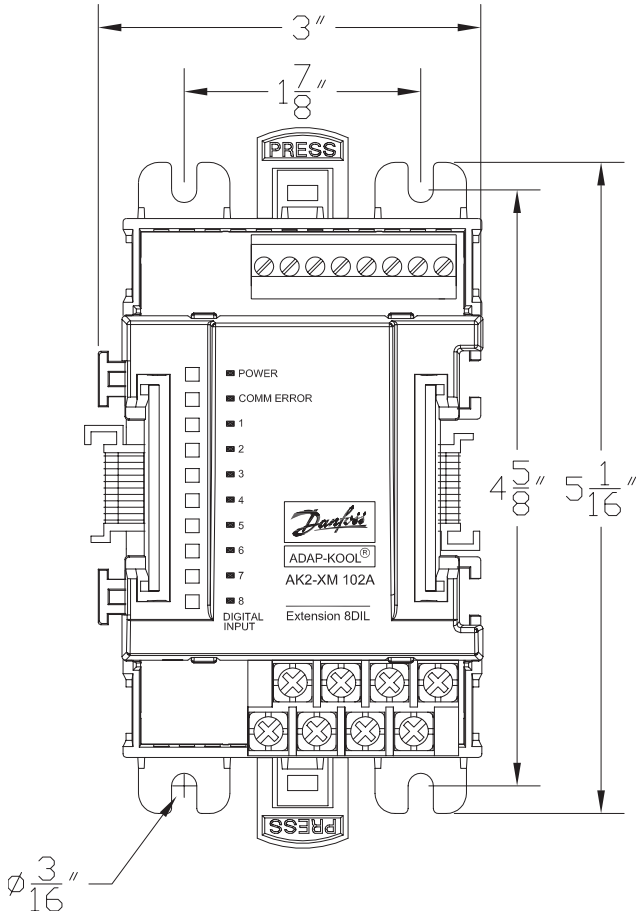

UL file number	E166834
Low voltage digital inputs:	8
Input rating:	9-80 Vac or Vdc
Power supply:	18-36 Vdc, 0.7 W supplied by communication module
Power required to communication module:	0.8 W @ 24 Vdc 1.0 VA @ 24 Vac
Operating temperature:	-4°F to 131°F (-20 to +55°C) @ 0 to 90% RH (non-condensing)
	-4°F to 104°F (-20 to +40°C) @ 0 to 95% RH (non-condensing)
Storage Temperature:	-40°F to 158°F (-40 to +70°C) @ 0 to 95% RH (non-condensing)

Specifications – AK2-XM 102A digital input module (high voltage)

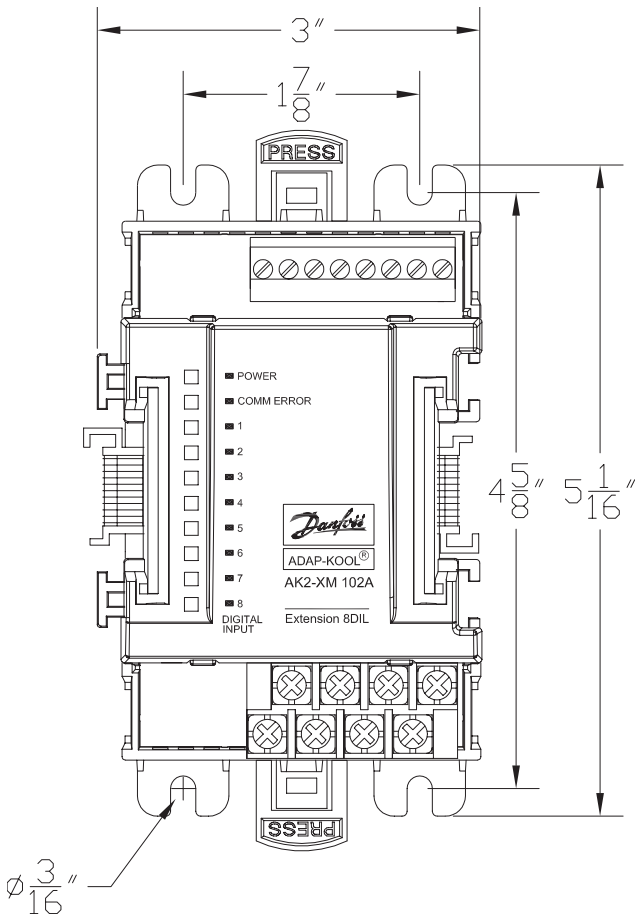

Digital inputs: 8
 Input rating: 95-260 VAC
 Power supply: 18-36 VDC, 0.7W supplied by communication module

Power required, to communication module:
 0.8W @ 24 VDC
 1.0 VA @ 24 VAC

Operating temperature:
 -4°F to 131°F (-20 to +55°C)
 @ 0 to 90% RH (non-condensing)
 -4°F to 104°F (-20 to +40°C)
 @ 0 to 95% RH (non-condensing)

Storage Temperature:
 -40°F to 158°F (-40 to +70°C)
 @ 0 to 95% RH (non-condensing)

Specifications – AK2-XM 208B bipolar stepper output module

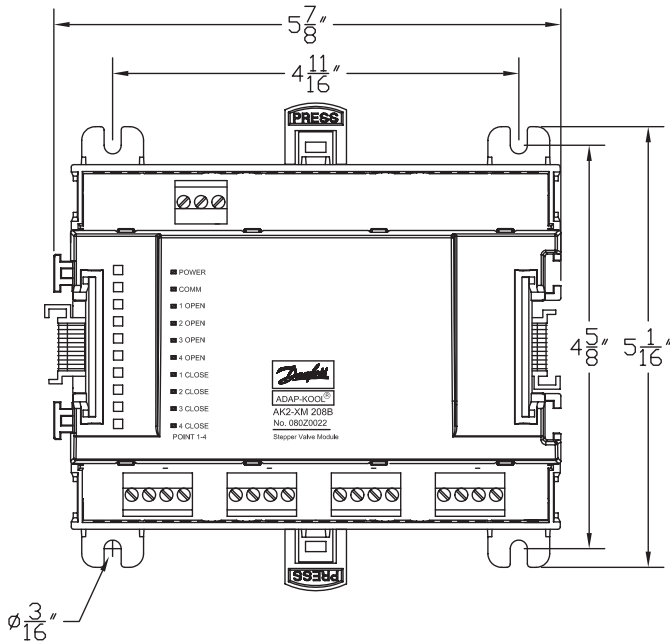

Bipolar stepper outputs 4
 Input rating: 95-260 Vac
 Power supply: 18-36 Vdc, 0.7 W supplied by communication module

Power required, to communication module:
 0.8 W @ 24 Vdc
 1.0 VA @ 24 Vac

Power supplied by module to operate valves:
 13 VA @ 12 or 24 Vdc
 (brand dependent)

Operating temperature:
 -4°F to 131°F (-20 to +55°C)
 @ 0 to 90% RH (non-condensing)
 -4°F to 104°F (-20 to +40°C)
 @ 0 to 95% RH (non-condensing)

Storage Temperature:
 -40°F to 158°F (-40 to +70°C)
 @ 0 to 95% RH (non-condensing)

Code numbers for ordering

Code #	Description
080Z0005	AK2-XM 205A, EXT.MODULE, 8AI/8DO
080Z0006	AK2-XM 204A, EXT.MODULE, 8DO
080Z0007	AK2-XM 101A, EXT.MODULE, 8AI
080Z0008	AK2-XM 102A, EXT.MODULE, 8DI LOW VOLTAGE
080Z0009	AK2-XM 102B, EXT.MODULE, 8DI HIGH VOLTAGE
080Z0010	AK2-XM 205A, EXT.MODULE, 8AI/8DO
080Z0011	AK2-XM 204A, EXT.MODULE, 8DO
080Z0012	AK2-XM 102A, EXT.MODULE, 8DI
080Z0013	AK2-XM 102B, EXT.MODULE, 8DI HIGH VOLTAGE
080Z0015	AK2-XM 205B, EXT.MODULE, 8AI/8DO
080Z0016	AK2-XM 204B, EXT.MODULE, 8DO
080Z0017	AK2-XM 205B, EXT.MODULE, 8AI/8DO
080Z0018	AK2-XM 204B, EXT.MODULE, 8DO
080Z0020	AK2-XM 107A, PULSE COUNTER MODULE
080Z0022	AK2-XM 208B, STEPPER VALVE MODULE
080Z0052	POWER SUPPLY FOR I/O (56 VA IPOS)
080Z0061	POWER SUPPLY FOR I/O AK2-CM 101A, COMM TP-78AK2-CM 101A, COMM



ADAP-KOOL® Refrigeration Control Systems is a trademark of Danfoss A/S, www.danfoss.com

Danfoss Inc., Refrigeration & Air-Conditioning Division, 7941 Corporate Drive, Baltimore, MD 21236 Tel. 410-931-8250, Fax 410-931-8256,
www.danfoss.com/North_America

Danfoss shall not be responsible for any errors in catalogs, brochures, or other printed material. Danfoss reserves the right to alter its products at any time without notice, provided that alterations to products already on order shall not require material changes in specifications previously agreed upon by Danfoss and the Purchaser. All trademarks in this material are property of the respective companies. Danfoss and the Danfoss logotype are trademarks of Danfoss A/S. All rights reserved.