



Programming Guide

VLT[®] HVAC Drive

Contents

1 Introduction	1-1
1.1.1 Copyright, Limitation of Liability and Revision Rights	1-1
1.1.2 Approvals	1-1
1.1.3 Symbols	1-1
1.1.4 Abbreviations	1-2
1.1.6 Definitions	1-3
2 How to Program	2-1
2.1 Local Control Panel	2-1
2.1.1 How to Operate the GraphicalLCP (GLCP)	2-1
2.1.2 How to Operate Numeric LCP (NLCP)	2-5
2.1.5 Quick Menu Mode	2-7
2.1.6 Function Set-ups	2-9
2.1.7 Main Menu Mode	2-13
3 Parameter Description	3-1
3.1 Parameter Selection	3-1
3.1.1 Main Menu Structure	3-1
3.2 Main Menu - Operation and Display - Group 0	3-2
3.3 Main Menu - Load and Motor - Group 1	3-14
3.4 Main Menu - Brakes - Group 2	3-28
3.4.3 2-16 AC brake Max. Current	3-30
3.5 Main Menu - Reference/Ramps - Group 3	3-31
3.6 Main Menu - Limits/Warnings - Group 4	3-37
3.7 Main Menu - Digital In/Out - Group 5	3-41
3.7.4 5-13 Terminal 29 Digital Input	3-44
3.8 Main Menu - Analog In/Out - Group 6	3-54
3.9 Main Menu - Communications and Options - Group 8	3-60
3.10 Main Menu - Profibus - Group 9	3-67
3.11 Main Menu - CAN Fieldbus (Serial Communication bus) - Group 10	3-73
3.12 Main Menu - LonWorks - Group 11	3-77
3.13 Main Menu - Smart Logic - Group 13	3-78
3.14 Main Menu - Special Functions -Group 14	3-90
3.14.6 14-50 RFI 1	3-94
3.15 Main Menu - Drive Information - Group 15	3-97
3.16 Main Menu - Data Readouts - Group 16	3-103
3.17 Main Menu - Data Readouts 2 - Group 18	3-110
3.18 Main Menu - Adjustable Frequency Drive Closed-loop - Group 20	3-112

3.19 Main Menu - Extended Closed-loop - Group 21	3-123
3.20 Main Menu - Appl. Functions - Group 22	3-131
3.21 Main Menu - Time-based Functions - Group 23	3-144
3.22 Main Menu - Application Functions 2 - Group 24	3-155
3.23 Main Menu - Cascade Controller - Group 25	3-161
3.24 Main Menu - Analog I/O Option MCB 109 - Group 26	3-172
4 Troubleshooting	4-1
4.1 Troubleshooting	4-1
4.1.1 Alarm Words	4-5
4.1.2 Warning Words	4-6
4.1.3 Extended Status Words	4-7
4.1.4 Fault Messages	4-8
5 Parameter Lists	5-1
5.1 Parameter Options	5-1
5.1.1 Default settings	5-1
5.1.2 0-** Operation and Display	5-2
5.1.3 1-** Load / Motor	5-4
5.1.4 2-** Brakes	5-5
5.1.5 3-** Reference / Ramps	5-6
5.1.6 4-** Limits / Warnings	5-7
5.1.7 5-** Digital In / Out	5-7
5.1.8 6-** Analog In / Out	5-9
5.1.9 8-** Communication and Options	5-10
5.1.10 9-** Profibus	5-12
5.1.11 10-** CAN Fieldbus	5-13
5.1.12 11-** LonWorks	5-13
5.1.13 13-** Smart Logic Controller	5-14
5.1.14 14-** Special Functions	5-15
5.1.15 15-** FC Information	5-16
5.1.16 16-** Data Readouts	5-17
5.1.17 18-** Info & Readouts	5-19
5.1.18 20-** FC Closed-loop	5-20
5.1.19 21-** Ext. Closed-loop	5-22
5.1.20 22-** Application Functions	5-23
5.1.21 23-** Time-based Functions	5-25
5.1.22 24-** Application Functions 2	5-26
5.1.23 25-** Cascade Controller	5-27

5.1.24 26-** Analog I / O Option MCB 109	5-29
6 Index	6-1

1 Introduction

**VLT® HVAC Drive
FC 100 Series**



This guide can be used with all
VLT® HVAC Drive adjustable
frequency drives with software
version 3.7x.
The actual software version
number can be read from
15-43 Software Version.

Table 1.1

1.1.1 Copyright, Limitation of Liability and Revision Rights

This publication contains information proprietary to Danfoss. By accepting and using this manual, the user agrees that the information contained herein will be used solely for operating equipment from Danfoss or equipment from other vendors provided that such equipment is intended for communication with Danfoss equipment over a serial communication link. This publication is protected under the copyright laws of Denmark and most other countries.

Danfoss does not warrant that a software program produced according to the guidelines provided in this manual will function properly in every physical, hardware or software environment.

Although Danfoss has tested and reviewed the documentation within this manual, Danfoss makes no warranty or representation, neither expressed nor implied, with respect to this documentation, including its quality, performance, or fitness for a particular purpose.

In no event shall Danfoss be liable for direct, indirect, special, incidental, or consequential damages arising out of the use, or the inability to use information contained in

this manual, even if advised of the possibility of such damages. In particular, Danfoss is not responsible for any costs, including but not limited to those incurred as a result of lost profits or revenue, loss or damage of equipment, loss of computer programs, loss of data, the costs to substitute these, or any claims by third parties.

Danfoss reserves the right to revise this publication at any time and to make changes to its contents without prior notice or any obligation to notify former or present users of such revisions or changes.

1.1.2 Approvals



Table 1.2

1.1.3 Symbols

Symbols used in this guide.

NOTE!

Indicates something to be noted by the reader.

CAUTION

Indicates a potentially hazardous situation which, if not avoided, may result in minor or moderate injury or equipment damage.

WARNING

Indicates a potentially hazardous situation which, if not avoided, could result in death or serious injury.

* Indicates default setting

Table 1.3

1.1.4 Abbreviations

Alternating current	AC
American wire gauge	AWG
Ampere/AMP	A
Automatic Motor Adaptation	AMA
Current limit	I_{LIM}
Degrees Celsius	°C
Direct current	DC
Drive Dependent	D-TYPE
Electro Magnetic Compatibility	EMC
Electronic Thermal Relay	ETR
Adjustable frequency drive	FC
Gram	g
Hertz	Hz
Horsepower	hp
Kilohertz	kHz
Local Control Panel	LCP
Meter	m
Millihenry Inductance	mH
Milliamperere	mA
Millisecond	ms
Minute	min
Motion Control Tool	MCT
Nanofarad	nF
Newton Meters	Nm
Nominal motor current	$I_{M,N}$
Nominal motor frequency	$f_{M,N}$
Nominal motor power	$P_{M,N}$
Nominal motor voltage	$U_{M,N}$
Permanent Magnet motor	PM motor
Protective Extra Low Voltage	PELV
Printed Circuit Board	PCB
Rated Inverter Output Current	I_{INV}
Revolutions Per Minute	RPM
Regenerative terminals	Regen
Second	sec.
Synchronous Motor Speed	n_s
Torque limit	T_{LIM}
Volts	V
The maximum output current	$I_{VLT,MAX}$
The rated output current supplied by the Adjustable frequency drive	$I_{VLT,N}$

Table 1.4

1.1.5 Available Literature for VLT® HVAC Drive

- Instruction Manual MG.11.Ax.yy provides the necessary information for getting the Adjustable frequency drive up and running.
- Instruction Manual VLT® HVAC Drive High Power, MG.11.Fx.yy
- Design Guide MG.11.Bx.yy provides all technical information about the Adjustable frequency drive and customer design and applications.
- Programming Guide MG.11.Cx.yy provides information on how to program and includes complete parameter descriptions.
- Mounting Instruction, Analog I/O Option MCB 109, MI.38.Bx.yy
- Application Note, Temperature Derating Guide, MN.11.Ax.yy
- PC-based Configuration Tool MCT 10, MG.10.Ax.yy enables the user to configure the Adjustable frequency drive from a Windows™-based PC environment.
- Danfoss VLT® Energy Box software at www.danfoss.com/BusinessAreas/DrivesSolutions then choose PC Software Download
- VLT® HVAC Drive Drive Applications, MG.11.Tx.yy
- Instruction Manual VLT® HVAC Drive Profibus, MG.33.Cx.yy
- Instruction Manual VLT® HVAC Drive Device Net, MG.33.Dx.yy
- Instruction Manual VLT® HVAC Drive BACnet, MG.11.Dx.yy
- Instruction Manual VLT® HVAC Drive LonWorks, MG.11.Ex.yy
- Instruction Manual VLT® HVAC Drive Metasys, MG.11.Gx.yy
- Instruction Manual VLT® HVAC Drive FLN, MG.11.Zx.yy
- Output Filter Design Guide, MG.90.Nx.yy
- Brake Resistor Design Guide, MG.90.Ox.yy

x = Revision number

yy = Language code

Danfoss technical literature is available in print from your local Danfoss Sales Office or online at:
www.danfoss.com/BusinessAreas/DrivesSolutions/Documentations/Technical+Documentation.htm

1.1.6 Definitions

Adjustable frequency drive:

$I_{VLT,MAX}$

Maximum output current.

$I_{VLT,N}$

Rated output current supplied by the Adjustable frequency drive.

$U_{VLT,MAX}$

Maximum output voltage.

Input:

Control command

Start and stop the connected motor by means of LCP and digital inputs.

Functions are divided into two groups.

Functions in group 1 have higher priority than functions in group 2.

Group 1	Reset, Coasting stop, Reset and Coasting stop, Quick stop, DC braking, Stop and the [OFF] key.
Group 2	Start, Pulse start, Reversing, Start reversing, Jog and Freeze output

Table 1.5

Motor:

Motor Running

Torque generated on output shaft and speed from zero rpm to max. speed on motor.

f_{JOG}

Motor frequency when the jog function is activated (via digital terminals).

f_M

Motor frequency.

f_{MAX}

Maximum motor frequency.

f_{MIN}

Minimum motor frequency.

$f_{M,N}$

Rated motor frequency (nameplate data).

I_M

Motor current (actual).

$I_{M,N}$

Rated motor current (nameplate data).

$n_{M,N}$

Rated motor speed (nameplate data).

n_s

Synchronous motor speed

$$n_s = \frac{2 \times \text{par. 1} - 23 \times 60 \text{ s}}{\text{par. 1} - 39}$$

$P_{M,N}$

Rated motor power (nameplate data in kW or HP).

$T_{M,N}$

Rated torque (motor).

U_M

Instantaneous motor voltage.

$U_{M,N}$

Rated motor voltage (nameplate data).

Break-away torque

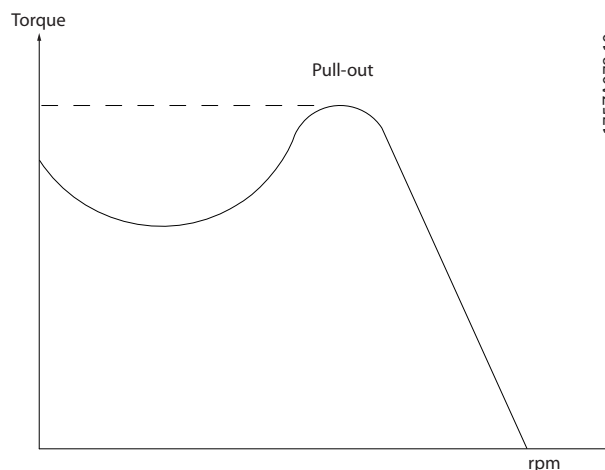

175ZA078.10

Figure 1.1

η_{VLT}

The efficiency of the Adjustable frequency drive is defined as the ratio between the power output and the power input.

Start-disable command

A stop command belonging to the group 1 control commands - see this group.

Stop command

See Control commands.

References:

Analog Reference

A signal transmitted to the analog inputs 53 or 54, can be voltage or current.

Binary Reference

A signal transmitted to the serial communication port.

Preset Reference

A defined preset reference to be set from -100% to +100% of the reference range. Selection of eight preset references via the digital terminals.

Pulse Reference

A pulse frequency signal transmitted to the digital inputs (terminal 29 or 33).

Ref_{MAX}

Determines the relationship between the reference input at 100% full scale value (typically 10 V, 20 mA) and the resulting reference. The maximum reference value set in 3-03 *Maximum Reference*.

Ref_{MIN}

Determines the relationship between the reference input at 0% value (typically 0 V, 0 mA, 4 mA) and the resulting reference. The minimum reference value set in 3-02 *Minimum Reference*.

Miscellaneous:Analog Inputs

The analog inputs are used for controlling various functions of the Adjustable frequency drive.

There are two types of analog inputs:

Current input, 0-20 mA and 4-20 mA

Voltage input, 0-10 V DC ()

Voltage input, -10 - +10 V DC (FC 102).

Analog Outputs

The analog outputs can supply a signal of 0–20 mA, 4–20 mA.

Automatic Motor Adaptation, AMA

AMA algorithm determines the electrical parameters for the connected motor at standstill.

Brake Resistor

The brake resistor is a module capable of absorbing the braking energy generated in regenerative braking. This regenerative braking energy increases the intermediate circuit voltage and a brake chopper ensures that the power is transmitted to the brake resistor.

CT Characteristics

Constant torque characteristics used for all applications such as conveyor belts, displacement pumps and cranes.

Digital Inputs

The digital inputs can be used for controlling various functions of the Adjustable frequency drive.

Digital Outputs

The Adjustable frequency drive features two solid state outputs that can supply a 24 V DC (max. 40 mA) signal.

DSP

Digital Signal Processor.

ETR

Electronic Thermal Relay is a thermal load calculation based on present load and time. Its purpose is to estimate the motor temperature.

Hiperface®

Hiperface® is a registered trademark by Stegmann.

Initializing

If initialization is carried out (*14-22 Operation Mode*), the Adjustable frequency drive returns to the default setting.

Intermittent Duty Cycle

An intermittent duty rating refers to a sequence of duty cycles. Each cycle consists of an on-load and an off-load period. The operation can be either periodic duty or non-periodic duty.

LCP

The Local Control Panel makes up a complete interface for control and programming of the Adjustable frequency drive. The control panel is detachable and can be installed up to 10 ft [3 m] from the Adjustable frequency drive, i.e., in a front panel by means of the installation kit option.

lsb

Least significant bit.

msb

Most significant bit.

MCM

Short for Mille Circular Mil, an American measuring unit for cable cross-section. 1 MCM = 0.5067 mm².

Online/Offline Parameters

Changes to online parameters are activated immediately after the data value is changed. Changes to offline parameters are not activated until you enter [OK] on the LCP.

Process PID

The PID control maintains the desired speed, pressure, temperature, etc. by adjusting the output frequency to match the varying load.

PCD

Process Control Data

Power Cycle

Switch off line power until the display (LCP) is dark – then turn power on again.

Pulse Input/Incremental Encoder

An external, digital pulse transmitter used for feeding back information on motor speed. The encoder is used in applications where great accuracy in speed control is required.

RCD

Residual Current Device.

Set-up

You can save parameter settings in four set-ups. Change between the four parameter set-ups, and edit one set-up, while another set-up is active.

SFAVM

Switching pattern called Stator Flux oriented Asynchronous Vector Modulation (14-00 Switching Pattern).

Slip Compensation

The Adjustable frequency drive compensates for the motor slip by giving the frequency a supplement that follows the measured motor load keeping the motor speed almost constant.

Smart Logic Control (SLC)

The SLC is a sequence of user-defined actions executed when the associated user-defined events are evaluated as true by the Smart Logic Controller. (Par. group 13-** Smart Logic Control (SLC)).

STW

Status Word

FC Standard Bus

Includes RS-485 bus with FC protocol or MC protocol. See 8-30 Protocol.

Thermistor

A temperature-dependent resistor placed where the temperature is to be monitored (Adjustable frequency drive or motor).

Trip

A state entered in fault situations, e.g., if the Adjustable frequency drive is subject to an over-temperature or when the Adjustable frequency drive is protecting the motor, process or mechanism. Restart is prevented until the cause of the fault has disappeared and the trip state is cancelled by activating reset or, in some cases, by being programmed to reset automatically. Trip may not be used for personal safety.

Trip Locked

A state entered in fault situations when the Adjustable frequency drive is protecting itself and requiring physical intervention, e.g., if the Adjustable frequency drive is subject to a short circuit on the output. A locked trip can only be canceled by cutting off line power, removing the cause of the fault, and reconnecting the Adjustable frequency drive. Restart is prevented until the trip state is cancelled by activating reset or, in some cases, by being programmed to reset automatically. Trip may not be used for personal safety.

VT Characteristics

Variable torque characteristics used for pumps and fans.

VVC^{plus}

If compared with standard voltage/frequency ratio control, Voltage Vector Control (VVC^{plus}) improves the dynamics and the stability, both when the speed reference is changed and in relation to the load torque.

60° AVM

Switching pattern called 60° Asynchronous Vector Modulation (14-00 Switching Pattern).

Power Factor

The power factor is the relation between I_1 and I_{RMS} .

$$\text{Power factor} = \frac{\sqrt{3} \times U \times I_1 \cos\varphi}{\sqrt{3} \times U \times I_{RMS}}$$

The power factor for 3-phase control:

$$= \frac{I_1 \times \cos\varphi}{I_{RMS}} = \frac{I_1}{I_{RMS}} \text{ since } \cos\varphi = 1$$

The power factor indicates to which extent the Adjustable frequency drive imposes a load on the line power supply. The lower the power factor, the higher the I_{RMS} for the same hp [kW] performance.

$$I_{RMS} = \sqrt{I_1^2 + I_5^2 + I_7^2 + \dots + I_n^2}$$

In addition, a high power factor indicates that the different harmonic currents are low.

The adjustable frequency drive's built-in DC coils produce a high power factor, which minimizes the imposed load on the line power supply.

WARNING

The voltage of the Adjustable frequency drive is dangerous whenever connected to line power. Incorrect installation of the motor, Adjustable frequency drive or serial communication bus may cause death, serious personal injury or damage to the equipment. Consequently, the instructions in this manual, as well as national and local rules and safety regulations, must be complied with.

Safety Regulations

1. The line power supply to the Adjustable frequency drive must be disconnected whenever repair work is to be carried out. Make sure that the line power supply has been disconnected and that the necessary time has elapsed before removing motor and line power supply plugs.
2. The [OFF] button on the control panel of the Adjustable frequency drive does not disconnect the line power supply and consequently it must not be used as a safety switch.

3. The equipment must be properly grounded, the user must be protected against supply voltage and the motor must be protected against overload in accordance with applicable national and local regulations.
4. The ground leakage current exceeds 3.5 mA.
5. Protection against motor overload is not included in the factory setting. If this function is desired, set *1-90 Motor Thermal Protection* to data value ETR trip 1 [4] or data value ETR warning 1 [3].
6. Do not remove the plugs for the motor and line power supply while the Adjustable frequency drive is connected to line power. Make sure that the line power supply has been disconnected and that the necessary time has elapsed before removing motor and line power plugs.
7. Please note that the Adjustable frequency drive has more voltage sources than L1, L2 and L3, when load sharing (linking of DC intermediate circuit) or external 24 V DC are installed. Make sure that all voltage sources have been disconnected and that the necessary time has elapsed before commencing repair work.

Warning against unintended start

1. The motor can be brought to a stop by means of digital commands, bus commands, references or a local stop, while the adjustable frequency drive is connected to line power. If personal safety considerations (e.g., risk of personal injury caused by contact with moving machine parts following an unintentional start) make it necessary to ensure that no unintended start occurs, these stop functions are not sufficient. In such cases, the line power supply must be disconnected or the *Safe Stop* function must be activated.
2. The motor may start while setting the parameters. If this means that personal safety may be compromised (e.g., personal injury caused by contact with moving machine parts), motor starting must be prevented, for instance by use of the *Safe Stop* function or secure disconnection of the motor connection.
3. A motor that has been stopped with the line power supply connected, may start if faults occur in the electronics of the adjustable frequency drive, through temporary overload or if a fault in the power supply grid or motor connection is remedied. If unintended start must be prevented for personal safety reasons (e.g., risk of injury caused by contact with moving machine parts), the normal stop functions of the adjustable

frequency drive are not sufficient. In such cases, the line power supply must be disconnected or the *Safe Stop* function must be activated.

4. Control signals from, or internally within, the adjustable frequency drive may in rare cases be activated in error, be delayed or fail to occur entirely. When used in situations where safety is critical, e.g., when controlling the electromagnetic brake function of a hoist application, these control signals must not be relied on exclusively.

⚠ WARNING

High Voltage

Touching the electrical parts may be fatal - even after the equipment has been disconnected from line power. Also make sure that other voltage inputs have been disconnected, such as external 24 V DC, load sharing (linkage of DC intermediate circuit), as well as the motor connection for kinetic backup. Systems where adjustable frequency drives are installed must, if necessary, be equipped with additional monitoring and protective devices according to the valid safety regulations, e.g., law on mechanical tools, regulations for the prevention of accidents, etc. Modifications on the adjustable frequency drives by means of the operating software are allowed.

NOTE!

Hazardous situations shall be identified by the machine builder/ integrator who is responsible for taking necessary preventive means into consideration. Additional monitoring and protective devices may be included, always according to valid national safety regulations, e.g., law on mechanical tools, regulations for the prevention of accidents.

Protection Mode

Once a hardware limit on motor current or DC-link voltage is exceeded the adjustable frequency drive will enter "protection mode". "Protection mode" means a change of the PWM modulation strategy and a low switching frequency to minimize losses. This continues 10 sec after the last fault and increases the reliability and the robustness of the adjustable frequency drive while re-establishing full control of the motor.

2 How to Program

2.1 Local Control Panel

2.1.1 How to Operate the GraphicalLCP (GLCP)

The following instructions are valid for the GLCP (LCP 102).

The GLCP is divided into four functional groups

1. Graphical display with Status lines.
2. Menu keys and indicator lights (LEDs) - selecting mode, changing parameters and switching between display functions.
3. Navigation keys and LEDs (LEDs).
4. Operation keys and LEDs.

Graphical display

The LCD-display is back-lit with a total of 6 alpha-numeric lines. All data is displayed on the LCP which can show up to five operating variables while in [Status] mode.

Display lines

- a. **Status line** Status messages displaying icons and graphics.
- b. **Line 1-2:** Operator data lines displaying data and variables defined or chosen by the user. By pressing the [Status] key, up to one extra line can be added.
- c. **Status line:** Status messages displaying text.

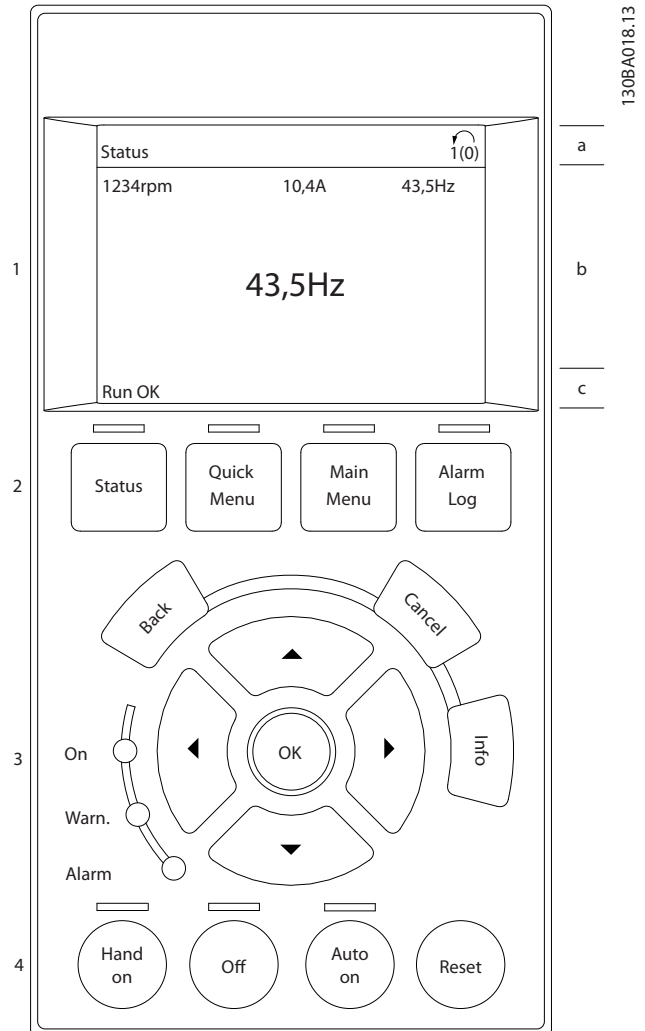

Figure 2.1

The display is divided into three sections.

Top section (a) shows the status when in status mode or up to two variables when not in status mode and in the case of Alarm/Warning.

The number of the Active Set-up (selected as the Active Set-up in *0-10 Active Set-up*) is shown. When programming in another set-up than the Active Set-up, the number of the set-up being programmed appears to the right in brackets.

2

The **Middle section** (b) shows up to five variables with related unit, regardless of status. In the case of an alarm/warning, the warning is shown instead of the variables.

The **Bottom section** (c) always shows the state of the Adjustable frequency drive in status mode.

It is possible to toggle between three status readout displays by pressing the [Status] key. Operating variables with different formatting are shown in each status screen - see below.

Several values or measurements can be linked to each of the displayed operating variables. The values / measurements to be displayed can be defined via 0-20 Display Line 1.1 Small, 0-21 Display Line 1.2 Small, 0-22 Display Line 1.3 Small, 0-23 Display Line 2 Large and 0-24 Display Line 3 Large, which can be accessed via [QUICK MENU], "Q3 Function Set-ups", "Q3-1 General Settings", "Q3-13 Display Settings".

Each value/measurement readout parameter selected in 0-20 Display Line 1.1 Small to 0-24 Display Line 3 Large has its own scale and number of digits after a possible decimal point. Larger numeric values are displayed with few digits after the decimal point.

Ex.: Current readout
5.25 A; 15.2 A 105 A.

Status display I

This readout state is standard after startup or initialization. Use [INFO] to obtain information about the value/measurement linked to the displayed operating variables (1.1, 1.2, 1.3, 2, and 3).

See the operating variables shown in the display in this illustration. 1.1, 1.2 and 1.3 are shown in small size. 2 and 3 are shown in medium size.

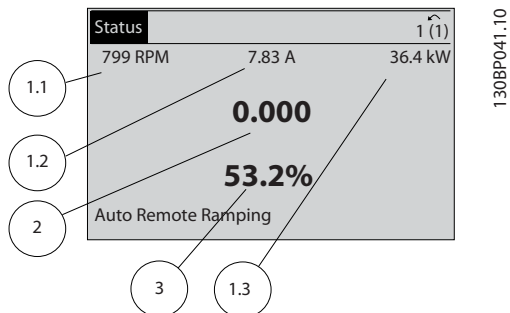

Figure 2.2

Status display II

See the operating variables (1.1, 1.2, 1.3, and 2) shown in the display in this figure.

In the example, Speed, Motor current, Motor power and Frequency are selected as variables in the first and second lines.

1.1, 1.2 and 1.3 are shown in small size. 2 is shown in large size.

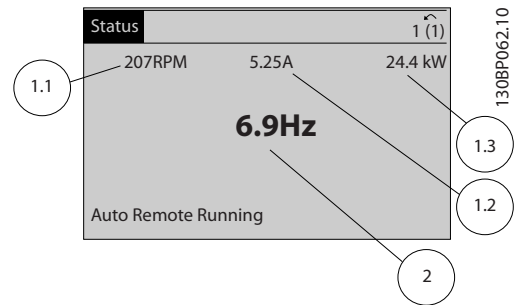

Figure 2.3

Status display III

This state displays the event and action of the Smart Logic Control. For further information, see 3.13 Main Menu - Smart Logic - Group 13.

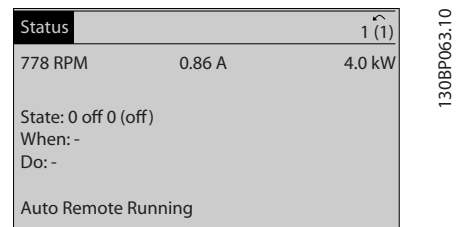

Figure 2.4

Display Contrast Adjustment

Press [status] and [▲] for darker display
Press [status] and [▼] for brighter display

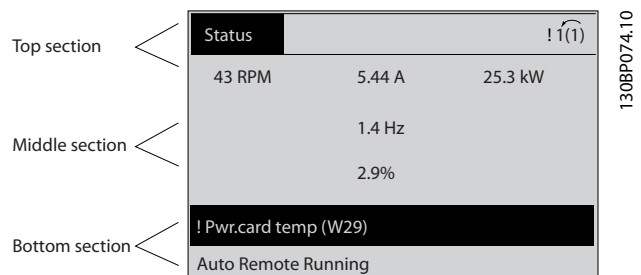

Figure 2.5

Indicator lights (LEDs)

If certain threshold values are exceeded, the alarm and/or warning LED lights up. A status and alarm text appear on the control panel.

The On LED is activated when the Adjustable frequency drive receives power from AC line voltage, a DC bus terminal, or an external 24V supply. At the same time, the back light is on.

- Green LED/On: Control section is working.
- Yellow LED/Warn.: Indicates a warning.
- Flashing Red LED/Alarm: Indicates an alarm.

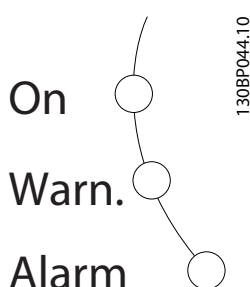

Figure 2.6

GLCP keys

Menu keys

The menu keys are divided into functions. The keys below the display and LEDs are used for parameter set-up, including choice of display indication during normal operation.



Figure 2.7

[Status]

indicates the status of the Adjustable frequency drive and/or the motor. Three different readouts can be chosen by pressing the [Status] key:

5-line readouts, 4-line readouts or Smart Logic Control.

Use **[Status]** for selecting the mode of display or for changing back to Display mode from either the Quick Menu mode, the Main Menu mode or Alarm mode. Also use the [Status] key to toggle single or double readout mode.

[Quick Menu]

allows quick set-up of the Adjustable frequency drive. **The most common VLT® HVAC Drive functions can be programmed here.**

The **[Quick Menu]** consists of

- **My Personal Menu**
- **Quick Set-up**
- **Function Set-up**
- **Changes Made**
- **Loggings**

The Function Set-up provides quick and easy access to all parameters required for the majority of VLT® HVAC Drive applications including most VAV and CAV supply and return fans, cooling tower fans, primary, secondary and condenser water pumps and other pump, fan and compressor applications. Among other features, it also includes parameters for selecting which variables to display on the LCP, digital preset speeds, scaling of analog references, closed-loop single zone and multi-zone applications and specific functions related to fans, pumps and compressors.

The Quick Menu parameters can be accessed immediately unless a password has been created via *0-60 Main Menu Password*, *0-61 Access to Main Menu w/o Password*, *0-65 Personal Menu Password* or *0-66 Access to Personal Menu w/o Password*.

It is possible to switch directly between Quick Menu mode and Main Menu mode.

[Main Menu]

is used for programming all parameters. The Main Menu parameters can be accessed immediately unless a password has been created via *0-60 Main Menu Password*, *0-61 Access to Main Menu w/o Password*, *0-65 Personal Menu Password* or *0-66 Access to Personal Menu w/o Password*. For the majority of VLT® HVAC Drive applications, it is not necessary to access the Main Menu parameters but instead the Quick Menu, Quick Set-up and Function Set-up provide the simplest and quickest access to parameters that are typically required.

It is possible to switch directly between Main Menu mode and Quick Menu mode.

Parameter shortcut can be carried out by pressing down the **[Main Menu]** key for three seconds. The parameter shortcut allows direct access to any parameter.

2

[Alarm Log]

displays an alarm list of the ten latest alarms (numbered A1-A10). To obtain additional details about an alarm, use the arrow keys to maneuver to the alarm number and press [OK]. Information is displayed about the condition of the Adjustable frequency drive before it enters the alarm mode.

The alarm log button on the LCP allows access to both alarm log and maintenance log.

[Back]

reverts to the previous step or layer in the navigation structure.

[Cancel]

last change or command will be cancelled as long as the display has not been changed.

[Info]

displays information about a command, parameter, or function in any display window. [Info] provides detailed information when needed. Exit Info mode by pressing either [Info], [Back], or [Cancel].

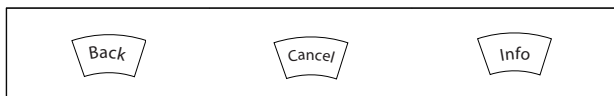

Table 2.1

Navigation Keys

The four navigation arrows are used to navigate between the different choices available in **[Quick Menu]**, **[Main Menu]** and **[Alarm Log]**. Use the keys to move the cursor.

[OK] is used for choosing a parameter marked by the cursor and for enabling the change of a parameter.

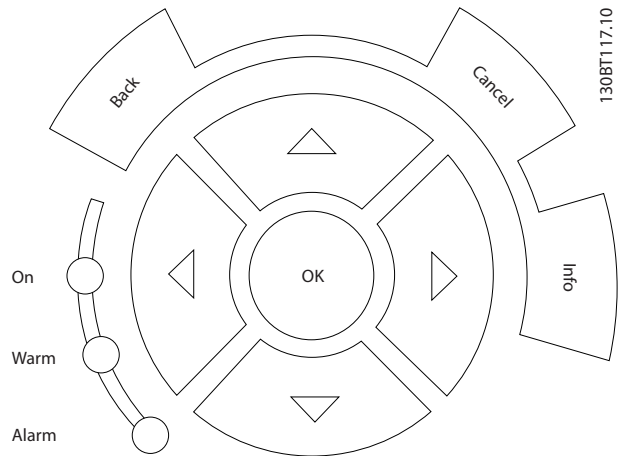

Figure 2.8

Operation keys for local control are found at the bottom of the control panel.

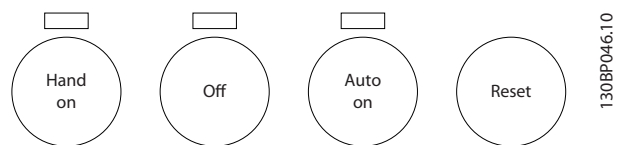

Figure 2.9

[Hand On]

enables control of the Adjustable frequency drive via the GLCP. [Hand On] also starts the motor, and it is now possible to enter the motor speed data by means of the arrow keys. The key can be selected as *Enable* [1] or *Disable* [0] via 0-40 [Hand on] Key on LCP.

The following control signals will still be active when [Hand On] is activated:

- [Hand On] - [Off] - [Auto On]
- Reset
- Coasting stop inverse
- Reversing
- Set-up select lsb - Set-up select msb
- Stop command from serial communication
- Quick stop
- DC brake

NOTE!

External stop signals activated by means of control signals or a serial bus will override a "start" command via the LCP.

[Off]

stops the connected motor. The key can be selected as Enabled [1] or Disabled [0] via 0-41 [Off] Key on LCP. If no external stop function is selected and the [Off] key is inactive the motor can only be stopped by disconnecting the line power supply.

[Auto On]

enables the Adjustable frequency drive to be controlled via the control terminals and/or serial communication. When a start signal is applied on the control terminals and/or the bus, the Adjustable frequency drive will start. The key can be selected as Enabled [1] or Disabled [0] via 0-42 [Auto on] Key on LCP.

NOTE!

An active HAND-OFF-AUTO signal via the digital inputs has higher priority than the control keys [Hand On] – [Auto On].

[Reset]

is used for resetting the Adjustable frequency drive after an alarm (trip). It can be selected as Enable [1] or Disable [0] via 0-43 [Reset] Key on LCP.

The parameter shortcut can be carried out by holding down the [Main Menu] key for three seconds. The parameter shortcut allows direct access to any parameter.

2.1.2 How to Operate Numeric LCP (NLCP)

The following instructions are valid for the NLCP (LCP 101). The control panel is divided into four functional groups:

1. Numeric display.
2. Menu key and indicator lights (LEDs) - changing parameters and switching between display functions.
3. Navigation keys and LEDs (LEDs).
4. Operation keys and LEDs.

NOTE!

Parameter copy is not possible with Numeric Local Control Panel (LCP101).

Select one of the following modes:

Status Mode: Displays the status of the Adjustable frequency drive or the motor.

If an alarm occurs, the NLCP automatically switches to status mode.

A number of alarms can be displayed.

Quick Set-up or Main Menu Mode: Display parameters and parameter settings.

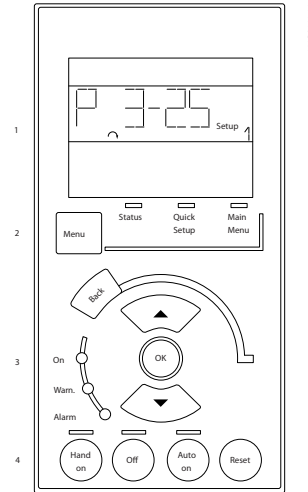

Figure 2.10 Numerical LCP (NLCP)

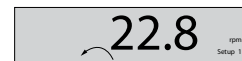

Figure 2.11 Status Display Example

LEDs:

- Green LED/On: Indicates if control section is on.
- Yellow LED/Wrn.: Indicates a warning.
- Flashing red LED/Alarm: Indicates an alarm.



Figure 2.12 Alarm Display Example

Menu key

[Menu] Select one of the following modes:

- Status
- Quick Setup
- Main Menu

Main Menu is used for programming all parameters.

The parameters can be accessed immediately unless a password has been created via 0-60 Main Menu Password, 0-61 Access to Main Menu w/o Password, 0-65 Personal Menu Password or 0-66 Access to Personal Menu w/o Password.

Quick Setup is used to set up the Adjustable frequency drive using only the most essential parameters.

The parameter values can be changed using the up/down arrows when the value is flashing.

2

Select Main Menu by pressing the [Menu] key a number of times until the Main Menu LED is lit.
 Select the parameter group [xx-__] and press [OK]
 Select the parameter [__-xx] and press [OK]
 If the parameter is an array parameter, select the array number and press [OK]
 Select the wanted data value and press [OK]

Navigation Keys [Back] for stepping backwards
 Arrow [▼] [▲] keys are used for navigating between parameter groups, parameters and within parameters.
[OK] is used for choosing a parameter marked by the cursor and for enabling the change of a parameter.

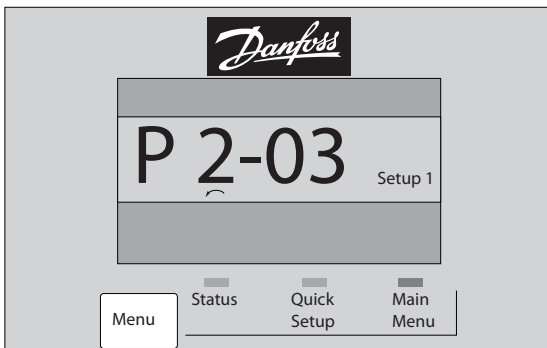

Figure 2.13

130BP079.10

Operation Keys

Keys for local control are found at the bottom of the control panel.

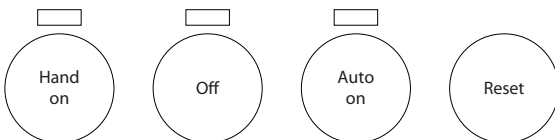

Figure 2.14 Operation keys of the numerical CP (NLCP)

130BP046.10

[Hand On] enables control of the Adjustable frequency drive via the LCP. [Hand on] also starts the motor and it is now possible to enter the motor speed data by means of the arrow keys. The key can be selected as Enable [1] or Disable [0] via 0-40 [Hand on] Key on LCP.

External stop signals activated by means of control signals or a serial bus will override a 'start' command via the LCP. The following control signals will still be active when [Hand on] is activated:

- [Hand on] - [Off] - [Auto on]
- Reset
- Coasting stop inverse
- Reversing
- Set-up select lsb - Set-up select msb
- Stop command from serial communication
- Quick stop
- DC brake

[Off] stops the connected motor. The key can be selected as Enable [1] or Disable [0] via 0-41 [Off] Key on LCP. If no external stop function is selected and the [Off] key is inactive, the motor can be stopped by disconnecting the line power supply.

[Auto On] enables the Adjustable frequency drive to be controlled via the control terminals and/or serial communication. When a start signal is applied on the control terminals and/or the bus, the Adjustable frequency drive will start. The key can be selected as Enable [1] or Disable [0] via 0-42 [Auto on] Key on LCP.

NOTE!

An active HAND-OFF-AUTO signal via the digital inputs has higher priority than the control keys [Hand On] [Auto On].

[Reset] is used for resetting the Adjustable frequency drive after an alarm (trip). It can be selected as Enable [1] or Disable [0] via 0-43 [Reset] Key on LCP.

2.1.3 Quick Transfer of Parameter Settings between Multiple Adjustable Frequency Drives

Once the set-up of a Adjustable frequency drive is complete, we recommend that you store the data in the LCP or on a PC via MCT 10 Set-up Software Tool.

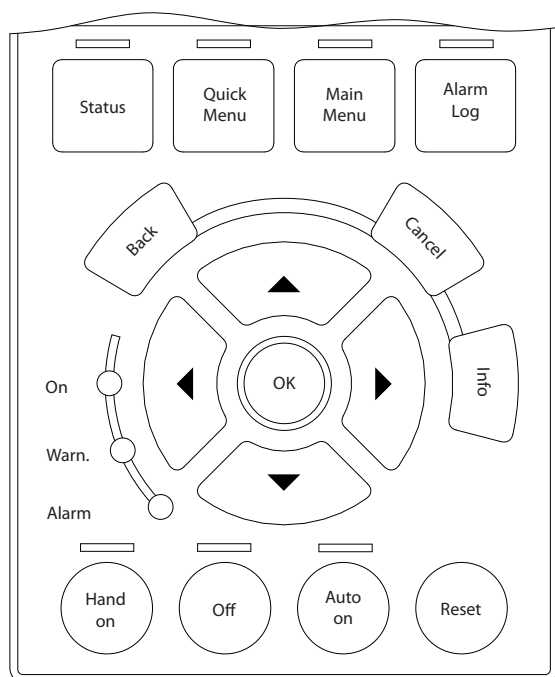

130BA027.10

Figure 2.15

Data storage in LCP

1. Go to 0-50 LCP Copy
2. Press the [OK] key
3. Select "All to LCP"
4. Press the [OK] key

All parameter settings are now stored in the LCP indicated by the progress bar. When 100% is reached, press [OK].

NOTE!

Stop the motor before performing this operation.

Connect the LCP to another Adjustable frequency drive and copy the parameter settings to this Adjustable frequency drive as well.

Data transfer from LCP to Adjustable frequency drive

1. Go to 0-50 LCP Copy
2. Press the [OK] key
3. Select "All from LCP"
4. Press the [OK] key

The parameter settings stored in the LCP are now transferred to the Adjustable frequency drive indicated by the progress bar. When 100% is reached, press [OK].

NOTE!

Stop the motor before performing this operation.

2.1.4 Parameter Set-up

The Adjustable frequency drive can be used for practically all assignments, thus offering a significant number of parameters. The series offers a choice between two programming modes - the Quick Menu mode and the Main Menu mode.

The latter provides access to all parameters. The former takes the user through a few parameters making it possible to **program the majority of VLT® HVAC Drive applications.**

Regardless of the mode of programming, parameters can be changed in both Quick Menu mode and in Main Menu mode.

2.1.5 Quick Menu Mode

Parameter Data

The graphical display (GLCP) provides access to all parameters listed under the quick menus. The numeric display (NLCP) only provides access to the quick set-up parameters. To set parameters using the [Quick Menu] button, enter or change parameter data or settings in accordance with the following procedure:

1. Press the Quick Menu button
2. Use the [▲] and [▼] buttons to find the parameter you want to change
3. Press [OK]
4. Use [▲] and [▼] buttons to select the correct parameter setting
5. Press [OK]
6. To move to a different digit within a parameter setting, use the [◀] and [▶] buttons
7. Highlighted area indicates digit selected for change
8. Press [Cancel] button to disregard change, or press [OK] to accept change and enter the new setting

Example of changing parameter data

Assume 22-60 Broken Belt Function is set to [Off]. However, you want to monitor the fan-belt condition - non- broken or broken - according to the following procedure

1. Press Quick Menu key
2. Choose Function Setups with the [▼] button
3. Press [OK]
4. Choose Application Settings with the [▼] button
5. Press [OK]

6. Press [OK] again for Fan Functions
7. Choose Broken Belt Function by pressing [OK]
8. With [▼] button, choose [2] Trip
7. Change '2' to '0' with the [▼] button
8. Press [OK]

The adjustable frequency drive will now trip if a broken fan belt is detected.

Select [My Personal Menu] to display personal parameters.

For example, an AHU or pump OEM may have pre-programmed personal parameters put into My Personal Menu during factory commissioning to make on-site commissioning/fine tuning simpler. These parameters are selected in 0-25 My Personal Menu. Up to 20 different parameters can be programmed in this menu.

Select [Changes Made] to get information about

- The last 10 changes. Use the up/down navigation keys to scroll between the last 10 changed parameters.
- The changes made since default setting.

Select [Loggings]

to get information about the display line readouts. The information is shown as graphs.

Only display parameters selected in 0-20 Display Line 1.1 Small and 0-24 Display Line 3 Large can be viewed. It is possible to store up to 120 samples in the memory for later reference.

Quick Setup

Efficient Parameter Set-up for VLT® HVAC Drive Applications

The parameters can easily be set up for the vast majority of the VLT® HVAC Drive applications only by using the [Quick Set-up] option.

After pressing [Quick Menu], the different choices in the Quick Menu are listed. See also figure 6.1 below and tables Q3-1 to Q3-4 in the following *Function Setups* section.

Example of using the Quick Setup option

Assume you want to set the Ramp Down Time to 100 seconds:

1. Select [Quick Setup]. 0-01 Language in Quick Setup appears
2. Press [▼] repeatedly until 3-42 Ramp 1 Ramp-down Time appears with the default setting of 20 seconds
3. Press [OK]
4. Use the [◀] button to highlight the third digit before the comma
5. Change '0' to '1' by using the [▲] button
6. Use the [▶] button to highlight the digit '2'

The new ramp-down time is now set to 100 sec. It is recommended to do the set-up in the order listed.

NOTE!

A complete description of the function is found in 3 Parameter Description.

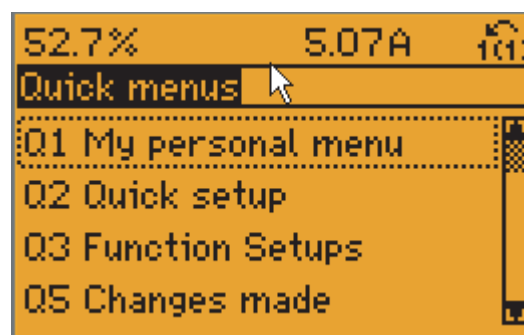

130BP064.11

Figure 2.16 Quick Menu View

The Quick Setup menu gives access to the 18 most important set-up parameters of the adjustable frequency drive. After programming, the adjustable frequency drive will, in most cases, be ready for operation. The 18 Quick Setup parameters are shown in the table below. A complete description of the function is given in the parameter description sections of this manual.

Parameter	[Units]
0-01 Language	
1-20 Motor Power [kW]	[kW]
1-21 Motor Power [HP]	[HP]
1-22 Motor Voltage*	[V]
1-23 Motor Frequency	[Hz]
1-24 Motor Current	[A]
1-25 Motor Nominal Speed	[RPM]
1-28 Motor Rotation Check	[Hz]
3-41 Ramp 1 Ramp-up Time	[s]
3-42 Ramp 1 Ramp-down Time	[s]
4-11 Motor Speed Low Limit [RPM]	[RPM]
4-12 Motor Speed Low Limit [Hz]*	[Hz]
4-13 Motor Speed High Limit [RPM]	[RPM]
4-14 Motor Speed High Limit [Hz]*	[Hz]
3-19 Jog Speed [RPM]	[RPM]
3-11 Jog Speed [Hz]*	[Hz]
5-12 Terminal 27 Digital Input	
5-40 Function Relay**	

Table 2.2 Quick Setup parameters

*The display showing depends on choices made in 0-02 Motor Speed Unit and 0-03 Regional Settings. The default settings of 0-02 Motor Speed Unit and 0-03 Regional Settings depend on which region of the world the adjustable frequency drive is supplied to but can be re-programmed as required.

** 5-40 Function Relay is an array, where one may choose between Relay1 [0] or Relay2 [1]. Standard setting is Relay1 [0] with the default choice Alarm [9].

See the parameter description in the section Commonly Used Parameters.

For detailed information about settings and programming, please see the VLT® HVAC Drive Programming Guide, MG. 11.CX.YY

x=version number
y=language

NOTE!

If [No Operation] is selected in 5-12 Terminal 27 Digital Input, no connection to +24V on terminal 27 is necessary to enable start.

If [Coast Inverse] (factory default value) is selected in 5-12 Terminal 27 Digital Input, a connection to +24 V is necessary to enable start.

2.1.6 Function Set-ups

The Function Set-up provides quick and easy access to all parameters required for the majority of VLT® HVAC Drive applications including most VAV and CAV supply and return fans, cooling tower fans, primary, secondary and condenser water pumps and other pump, fan and compressor applications.

How to Access Function Setup - Example

Step 1: Turn on the Adjustable frequency drive (yellow LED lights)

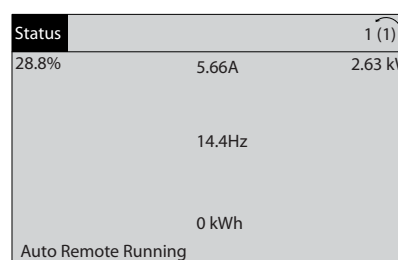

Figure 2.17

Step 2: Press the [Quick Menu] button (Quick Menu choices appear).

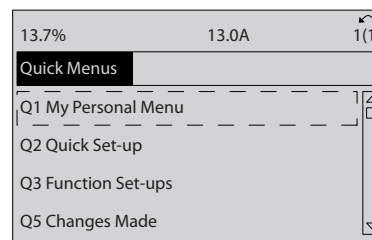

Figure 2.18

Step 3: Use the up/down navigation keys to scroll down to Function set-ups. Press [OK].

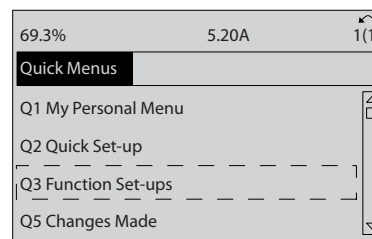

Figure 2.19

2

Step 4: Function setups choices appear. Choose Q3-1 *General Settings*. Press [OK].

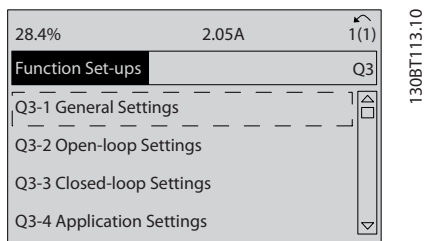

Figure 2.20

Step 5: Use the up/down navigation keys to scroll down to, e.g., Q3-11 *Analog Outputs*. Press [OK].

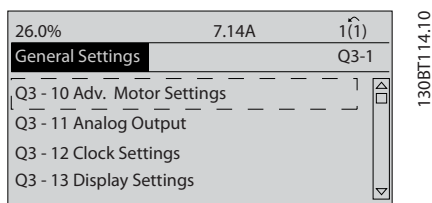

Figure 2.21

Step 6: Choose 6-50 *Terminal 42 Output*. Press [OK].

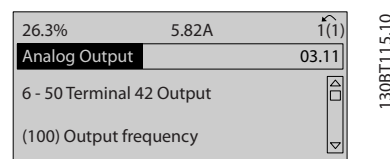

Figure 2.22

Step 7: Use the up/down navigation keys to select between the different choices. Press [OK].

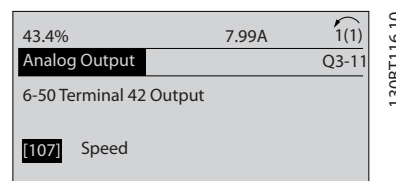

Figure 2.23

Function Setups parameters

The Function Setup parameters are grouped in the following way

Q3-1 General Settings			
Q3-10 Adv. Motor Settings	Q3-11 Analog Output	Q3-12 Clock Settings	Q3-13 Display Settings
1-90 Motor Thermal Protection	6-50 Terminal 42 Output	0-70 Date and Time	0-20 Display Line 1.1 Small
1-93 Thermistor Source	6-51 Terminal 42 Output Min Scale	0-71 Date Format	0-21 Display Line 1.2 Small
1-29 Automatic Motor Adaptation (AMA)	6-52 Terminal 42 Output Max Scale	0-72 Time Format	0-22 Display Line 1.3 Small
14-01 Switching Frequency		0-74 DST/Summertime	0-23 Display Line 2 Large
4-53 Warning Speed High		0-76 DST/Summertime Start	0-24 Display Line 3 Large
		0-77 DST/Summertime End	0-37 Display Text 1
			0-38 Display Text 2
			0-39 Display Text 3

Table 2.3

Q3-2 Open-loop Settings	
Q3-20 Digital Reference	Q3-21 Analog Reference
3-02 Minimum Reference	3-02 Minimum Reference
3-03 Maximum Reference	3-03 Maximum Reference
3-10 Preset Reference	6-10 Terminal 53 Low Voltage
5-13 Terminal 29 Digital Input	6-11 Terminal 53 High Voltage
5-14 Terminal 32 Digital Input	6-12 Terminal 53 Low Current
5-15 Terminal 33 Digital Input	6-13 Terminal 53 High Current
	6-14 Terminal 53 Low Ref./Feedb. Value
	6-15 Terminal 53 High Ref./Feedb. Value

Table 2.4

Q3-3 Closed-loop Settings		
Q3-30 Single Zone Int. Setpoint	Q3-31 Single Zone Ext. Setpoint	Q3-32 Multi Zone / Adv
1-00 Configuration Mode	1-00 Configuration Mode	1-00 Configuration Mode
20-12 Reference/Feedback Unit	20-12 Reference/Feedback Unit	3-15 Reference 1 Source
20-13 Minimum Reference/Feedb.	20-13 Minimum Reference/Feedb.	3-16 Reference 2 Source
20-14 Maximum Reference/Feedb.	20-14 Maximum Reference/Feedb.	20-00 Feedback 1 Source
6-22 Terminal 54 Low Current	6-10 Terminal 53 Low Voltage	20-01 Feedback 1 Conversion
6-24 Terminal 54 Low Ref./Feedb. Value	6-11 Terminal 53 High Voltage	20-02 Feedback 1 Source Unit
6-25 Terminal 54 High Ref./Feedb. Value	6-12 Terminal 53 Low Current	20-03 Feedback 2 Source
6-26 Terminal 54 Filter Time Constant	6-13 Terminal 53 High Current	20-04 Feedback 2 Conversion
6-27 Terminal 54 Live Zero	6-14 Terminal 53 Low Ref./Feedb. Value	20-05 Feedback 2 Source Unit
6-00 Live Zero Timeout Time	6-15 Terminal 53 High Ref./Feedb. Value	20-06 Feedback 3 Source
6-01 Live Zero Timeout Function	6-22 Terminal 54 Low Current	20-07 Feedback 3 Conversion
20-21 Setpoint 1	6-24 Terminal 54 Low Ref./Feedb. Value	20-08 Feedback 3 Source Unit
20-81 PID Normal/ Inverse Control	6-25 Terminal 54 High Ref./Feedb. Value	20-12 Reference/Feedback Unit
20-82 PID Start Speed [RPM]	6-26 Terminal 54 Filter Time Constant	20-13 Minimum Reference/Feedb.
20-83 PID Start Speed [Hz]	6-27 Terminal 54 Live Zero	20-14 Maximum Reference/Feedb.
20-93 PID Proportional Gain	6-00 Live Zero Timeout Time	6-10 Terminal 53 Low Voltage
20-94 PID Integral Time	6-01 Live Zero Timeout Function	6-11 Terminal 53 High Voltage
20-70 Closed-loop Type	20-81 PID Normal/ Inverse Control	6-12 Terminal 53 Low Current
20-71 PID Performance	20-82 PID Start Speed [RPM]	6-13 Terminal 53 High Current
20-72 PID Output Change	20-83 PID Start Speed [Hz]	6-14 Terminal 53 Low Ref./Feedb. Value
20-73 Minimum Feedback Level	20-93 PID Proportional Gain	6-15 Terminal 53 High Ref./Feedb. Value
20-74 Maximum Feedback Level	20-94 PID Integral Time	6-16 Terminal 53 Filter Time Constant
20-79 PID Autotuning	20-70 Closed-loop Type	6-17 Terminal 53 Live Zero
	20-71 PID Performance	6-20 Terminal 54 Low Voltage
	20-72 PID Output Change	6-21 Terminal 54 High Voltage
	20-73 Minimum Feedback Level	6-22 Terminal 54 Low Current
	20-74 Maximum Feedback Level	6-23 Terminal 54 High Current
	20-79 PID Autotuning	6-24 Terminal 54 Low Ref./Feedb. Value
		6-25 Terminal 54 High Ref./Feedb. Value
		6-26 Terminal 54 Filter Time Constant
		6-27 Terminal 54 Live Zero
		6-00 Live Zero Timeout Time
		6-01 Live Zero Timeout Function
		4-56 Warning Feedback Low
		4-57 Warning Feedback High
		20-20 Feedback Function
		20-21 Setpoint 1
		20-22 Setpoint 2
		20-81 PID Normal/ Inverse Control
		20-82 PID Start Speed [RPM]
		20-83 PID Start Speed [Hz]
		20-93 PID Proportional Gain
		20-94 PID Integral Time
		20-70 Closed-loop Type
		20-71 PID Performance
		20-72 PID Output Change
		20-73 Minimum Feedback Level
		20-74 Maximum Feedback Level
		20-79 PID Autotuning

Table 2.5

Q3-4 Application Settings		
Q3-40 Fan Functions	Q3-41 Pump Functions	Q3-42 Compressor Functions
22-60 Broken Belt Function	22-20 Low Power Auto Set-up	1-03 Torque Characteristics
22-61 Broken Belt Torque	22-21 Low Power Detection	1-71 Start Delay
22-62 Broken Belt Delay	22-22 Low Speed Detection	22-75 Short Cycle Protection
4-64 Semi-Auto Bypass Set-up	22-23 No-Flow Function	22-76 Interval between Starts
1-03 Torque Characteristics	22-24 No-Flow Delay	22-77 Minimum Run Time
22-22 Low Speed Detection	22-40 Minimum Run Time	5-01 Terminal 27 Mode
22-23 No-Flow Function	22-41 Minimum Sleep Time	5-02 Terminal 29 Mode
22-24 No-Flow Delay	22-42 Wake-up Speed [RPM]	5-12 Terminal 27 Digital Input
22-40 Minimum Run Time	22-43 Wake-up Speed [Hz]	5-13 Terminal 29 Digital Input
22-41 Minimum Sleep Time	22-44 Wake-up Ref./FB Difference	5-40 Function Relay
22-42 Wake-up Speed [RPM]	22-45 Setpoint Boost	1-73 Flying Start
22-43 Wake-up Speed [Hz]	22-46 Maximum Boost Time	1-86 Trip Speed Low [RPM]
22-44 Wake-up Ref./FB Difference	22-26 Dry Pump Function	1-87 Trip Speed Low [Hz]
22-45 Setpoint Boost	22-27 Dry Pump Delay	
22-46 Maximum Boost Time	22-80 Flow Compensation	
2-10 Brake Function	22-81 Square-linear Curve Approximation	
2-16 AC Brake Max. Current	22-82 Work Point Calculation	
2-17 Over-voltage Control	22-83 Speed at No-Flow [RPM]	
1-73 Flying Start	22-84 Speed at No-Flow [Hz]	
1-71 Start Delay	22-85 Speed at Design Point [RPM]	
1-80 Function at Stop	22-86 Speed at Design Point [Hz]	
2-00 DC Hold/Preheat Current	22-87 Pressure at No-Flow Speed	
4-10 Motor Speed Direction	22-88 Pressure at Rated Speed	
	22-89 Flow at Design Point	
	22-90 Flow at Rated Speed	
	1-03 Torque Characteristics	
	1-73 Flying Start	

Table 2.6

2.1.7 Main Menu Mode

Select main menu mode by pressing the [Main Menu] key. The readout below appears on the display. The middle and bottom sections on the display show a list of parameter groups which can be chosen by toggling the up and down buttons.

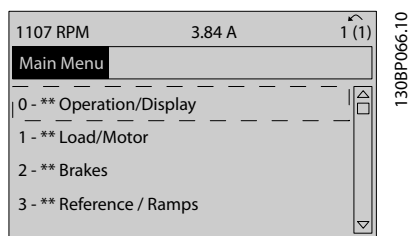

Figure 2.24

Each parameter has a name and number which remain the same regardless of the programming mode. In main menu mode, the parameters are divided into groups. The first digit of the parameter number (from the left) indicates the parameter group number.

All parameters can be changed in the Main Menu. However, depending on the choice of configuration (1-00 Configuration Mode), some parameters can be hidden.

2.1.8 Parameter Selection

In main menu mode, the parameters are divided into groups. You select a parameter group by means of the navigation keys.

2

The following parameter groups are accessible:

Group no.	Parameter group:
0	Operation/Display
1	Load/Motor
2	Brakes
3	References/Ramps
4	Limits/Warnings
5	Digital In/Out
6	Analog In/Out
8	Comm. and Options
9	Profibus
10	CAN Fieldbus (serial communication bus)
11	LonWorks
12	Ethernet IP / Modbus TCP / PROFINET
13	Smart Logic
14	Special Functions
15	Drive Information
16	Data Readouts
18	Data Readouts 2
20	Drive Closed-loop
21	Ext. Closed-Loop
22	Application Functions
23	Time-based Functions
25	Cascade Controller
26	Analog I/O Option MCB 109

Table 2.7

After selecting a parameter group, choose a parameter by means of the navigation keys. The middle section on the display shows the parameter number and name as well as the selected parameter value.

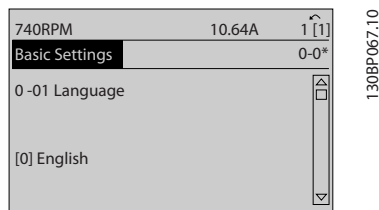

Figure 2.25

2.1.9 Changing Data

The procedure for changing data is the same whether you select a parameter in the quick menu or the main menu mode. Press [OK] to change the selected parameter. The procedure for changing data depends on whether the selected parameter represents a numerical data value or a text value.

2.1.10 Changing a Text Value

If the selected parameter is a text value, change the text value with the [▲] [▼] navigation keys. The up key increases the value, and the down key decreases the value. Place the cursor on the value you want to save and press [OK].

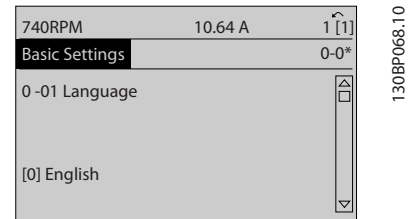

Figure 2.26

2.1.11 Changing a Group of Numeric Data Values

If the chosen parameter represents a numeric data value, change the chosen data value by means of the [◀] [▶] navigation keys as well as the [▲] [▼] navigation keys. Use the [◀] [▶] navigation keys to move the cursor horizontally.

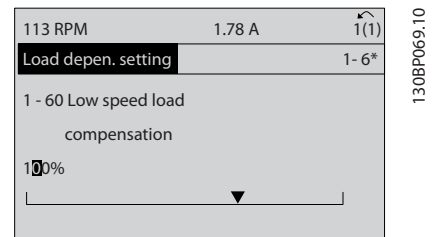

Figure 2.27

Use the [▲] [▼] navigation keys to change the data value. The up key enlarges the data value, and the down key reduces the data value. Place the cursor on the value you want to save and press [OK].

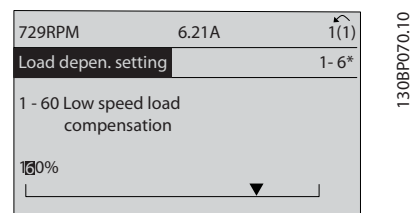

Figure 2.28

2.1.12 Value, Step-by-Step

Certain parameters can be changed step by step or infinitely varying. This applies to *1-20 Motor Power [kW]*, *1-22 Motor Voltage* and *1-23 Motor Frequency*. The parameters are changed both as a group of numeric data values and as numeric data values infinitely varying.

2.1.13 Readout and Programming of Indexed Parameters

Parameters are indexed when placed in a rolling stack. *15-30 Alarm Log: Error Code* to *15-33 Alarm Log: Date and Time* contain a fault log which can be read out. Choose a parameter, press [OK], and use the up/down navigation keys to scroll through the value log.

Use *3-10 Preset Reference* as another example: Choose the parameter, press [OK], and use the up/down navigation keys to scroll through the indexed values. To change the parameter value, select the indexed value and press [OK]. Change the value by using the up/down keys. Press [OK] to accept the new setting. Press [Cancel] to abort. Press [Back] to leave the parameter.

2.1.14 Initialization to Default Settings

Initialize the adjustable frequency drive to default settings in two ways.

Recommended initialization (via *14-22 Operation Mode*)

1. Select *14-22 Operation Mode*
2. Press [OK]
3. Select "initialization"
4. Press [OK]
5. Cut off the line power supply and wait until the display turns off.
6. Reconnect the line power supply - the adjustable frequency drive is now reset.
7. Change *14-22 Operation Mode* back to *Normal Operation*.

NOTE!

Resets parameters selected in Personal Menu with default factory setting.

- 14-22 Operation Mode* initializes all except
- 14-50 RFI 1*
- 8-30 Protocol*
- 8-31 Address*
- 8-32 Baud Rate*
- 8-35 Minimum Response Delay*
- 8-36 Maximum Response Delay*
- 8-37 Maximum Inter-Char Delay*
- 15-00 Operating Hours* to *15-05 Over Volts*
- 15-20 Historic Log: Event* to *15-22 Historic Log: Time*
- 15-30 Alarm Log: Error Code* to *15-32 Alarm Log: Time*

Manual initialization

1.	Disconnect from the line power and wait until the display turns off.
2a.	Press [Status] - [Main Menu] - [OK] at the same time while powering up for LCP 102, Graphical Display
2b.	Press [Menu] while powering up for LCP 101, Numerical Display
3.	Release the keys after 5 seconds
4.	The adjustable frequency drive is now programmed according to default settings.
This procedure initializes all except: <i>15-00 Operating Hours</i> ; <i>15-03 Power-ups</i> ; <i>15-04 Over Temps</i> ; <i>15-05 Over Volts</i> .	

Table 2.8

NOTE!

When you carry out manual initialization, you also reset serial communication, *14-50 RFI 1* and fault log settings. Removes parameters selected in *25-00 Cascade Controller*.

NOTE!

After initialization and power cycling, the display will not show any information for a couple of minutes.

3 Parameter Description

3.1 Parameter Selection

3.1.1 Main Menu Structure

Parameters for the adjustable frequency drive are grouped into various parameter groups for easy selection of the correct parameters for optimized operation of the adjustable frequency drive.

The vast majority of VLT® HVAC Drive applications can be programmed using the Quick Menu button and selecting the parameters under Quick Setup and Function Setups. Descriptions and default settings of parameters may be found under *5 Parameter Lists*.

- 0-** Operation/Display
- 1-** Load/Motor
- 2-** Brakes
- 3-** Reference/Ramps
- 4-** Limits/ Warnings
- 5-** Digital In/Out
- 6-** Analog In/Out
- 8-** Comm. and Options
- 9-** Profibus
- 10-** CAN Fieldbus (Serial communication bus)
- 11-** LonWorks
- 12-** Ethernet IP / Modbus TCP / PROFINET
- 13-** Smart Logic Controller
- 14-** Special Functions
- 15-** FC Information
- 16-** Data Readouts
- 18-** Info & Readouts
- 20-** FC Closed-loop
- 21-** Ext. Closed-Loop
- 22-** Application Functions
- 23-** Time-based Functions
- 24-** Application Functions 2
- 25-** Cascade Controller
- 26-** Analog I/O Option MCB 109

3.2 Main Menu - Operation and Display - Group 0

Parameters related to the fundamental functions of the Adjustable frequency drive, function of the LCP buttons and configuration of the LCP display.

3.2.1 0-0* Basic Settings

0-01 Language		
Option:	Function:	
	Defines the language to be used in the display. The adjustable frequency drive can be delivered with 2 different language packages. English and German are included in both packages. English cannot be erased or manipulated.	
[0] *	English	Part of Language packages 1 - 2
[1]	Deutsch	Part of Language packages 1 - 2
[2]	Francais	Part of Language package 1
[3]	Dansk	Part of Language package 1
[4]	Spanish	Part of Language package 1
[5]	Italiano	Part of Language package 1
[6]	Svenska	Part of Language package 1
[7]	Nederlands	Part of Language package 1
[10]	Chinese	Language package 2
[20]	Suomi	Part of Language package 1
[22]	English US	Part of Language package 1
[27]	Greek	Part of Language package 1
[28]	Bras.port	Part of Language package 1
[36]	Slovenian	Part of Language package 1
[39]	Korean	Part of Language package 2
[40]	Japanese	Part of Language package 2
[41]	Turkish	Part of Language package 1
[42]	Trad.Chinese	Part of Language package 2
[43]	Bulgarian	Part of Language package 1
[44]	Srpski	Part of Language package 1
[45]	Romanian	Part of Language package 1
[46]	Magyar	Part of Language package 1
[47]	Czech	Part of Language package 1
[48]	Polski	Part of Language package 1
[49]	Russian	Part of Language package 1
[50]	Thai	Part of Language package 2

0-01 Language		
Option:	Function:	
[51]	Bahasa Indonesia	Part of Language package 2
[52]	Hrvatski	

0-02 Motor Speed Unit		
Option:	Function:	
	The display showing depends on settings in <i>0-02 Motor Speed Unit</i> and <i>0-03 Regional Settings</i> . The default setting of <i>0-02 Motor Speed Unit</i> and <i>0-03 Regional Settings</i> depends on which region of the world the Adjustable frequency drive is supplied to, but can be re-programmed as required. NOTE! Changing the <i>Motor Speed Unit</i> will reset certain parameters to their initial value. It is recommended to select the motor speed unit first before modifying other parameters.	
[0]	RPM	Selects display of motor speed variables and parameters (i.e. references, feedbacks and limits) in terms of motor speed (RPM).
[1] *	Hz	Selects display of motor speed variables and parameters (i.e., references, feedbacks and limits) in terms of output frequency to the motor (Hz).

NOTE!

This parameter cannot be adjusted while the motor is running.

0-03 Regional Settings		
Option:	Function:	
	This parameter cannot be adjusted while the motor is running. The display showing depends on settings in <i>0-02 Motor Speed Unit</i> and <i>0-03 Regional Settings</i> . The default setting of <i>0-02 Motor Speed Unit</i> and <i>0-03 Regional Settings</i> depends on which region of the world the adjustable frequency drive is supplied to but can be re-programmed as required.	
[0] *	International	Sets <i>1-20 Motor Power [kW]</i> units to [kW] and the default value of <i>1-23 Motor Frequency</i> [50 Hz].
[1]	North America	Sets <i>1-21 Motor Power [HP]</i> units to HP and the default value of <i>1-23 Motor Frequency</i> to 60 Hz.

The setting not used is made invisible.

0-04 Operating State at Power-up		
Option:	Function:	
		Select the operating mode upon reconnection of the adjustable frequency drive to AC line voltage after power-down when operating in hand (local) mode.
[0] *	Resume	Resumes operation of the adjustable frequency drive maintaining the same local reference and the same start/stop condition (applied by [Hand On]/[Off] on the LCP or Hand Start via a digital input as before the adjustable frequency drive was powered down.
[1]	Forced stop, ref=old	Uses saved reference [1] to stop the adjustable frequency drive but at the same time retain in memory the local speed reference prior to power-down. After AC line voltage is reconnected and after receiving a start command (using the LCP [Hand On] button or Hand Start command via a digital input), the adjustable frequency drive restarts and operates at the retained speed reference.

3.2.2 0-1* Set-up Operations

Define and control the individual parameter set-ups. The adjustable frequency drive has four parameter set-ups that can be programmed independently of each other. This makes the adjustable frequency drive very flexible and able to meet the requirements of many different VLT® HVAC Drive system control schemes often saving the cost of external control equipment. For example, these can be used to program the adjustable frequency drive to operate according to one control scheme in one set-up (e.g., daytime operation) and another control scheme in another set-up (e.g., night set back). Alternatively, they can be used by an AHU or packaged unit OEM to identically program all their factory-fitted adjustable frequency drives to the same parameters on different equipment models within a range, and then during production/commissioning, only need a specific set-up selection depending on which model the adjustable frequency drive is installed on within that range.

The active set-up (i.e., the set-up in which the adjustable frequency drive is currently operating) can be selected in *0-10 Active Set-up* and is displayed in the LCP. Using Multi set-up, it is possible to switch between set-ups with the adjustable frequency drive running or stopped, via digital input or serial communication commands (e.g., for night set back). If it is necessary to change set-ups while running, ensure *0-12 This Set-up Linked to* is programmed as required. For the majority of VLT® HVAC Drive applications, it will not be necessary to program *0-12 This Set-up Linked to* even if a set-up must be changed while

running. For very complex applications which use the full flexibility of the multiple set-ups, it may be required. Using *0-11 Programming Set-up*, it is possible to edit parameters in any of the set-ups during adjustable frequency drive operation in its active set-up; this set-up can be different than the one being edited. Using *0-51 Set-up Copy*, it is possible to copy parameter settings between the set-ups to enable quicker commissioning if similar parameter settings are required in different set-ups.

0-10 Active Set-up		
Option:	Function:	
		Select the set-up in which the adjustable frequency drive is to operate. Use <i>0-51 Set-up Copy</i> to copy a set-up to one or all other set-ups. To avoid conflicting settings of the same parameter within two different set-ups, link the set-ups together using <i>0-12 This Set-up Linked to</i> . Stop the adjustable frequency drive before switching between set-ups, where parameters marked 'not changeable during operation' have different values. Parameters that are 'not changeable during operation' are marked FALSE in the parameter lists in the section Parameter Lists.
[0]	Factory setup	Cannot be changed. It contains the Danfoss data set, and can be used as a data source when returning the other set-ups to a known state.
[1] *	Set-up 1	<i>Set-up 1</i> [1] to <i>Set-up 4</i> [4] are the four separate parameter set-ups within which all parameters can be programmed.
[2]	Set-up 2	
[3]	Set-up 3	
[4]	Set-up 4	
[9]	Multi setup	Is used for remote selection of set-ups using digital inputs and the serial communication port. This set-up uses the settings from <i>0-12 This Set-up Linked to</i> .

0-11 Programming Set-up		
Option:	Function:	
		Select the set-up to be edited (i.e., programmed) during operation; either the active set-up or one of the inactive set-ups. The set-up number being edited is displayed in the LCP in (brackets).
[0]	Factory setup	cannot be edited, but it is useful as a data source to return the other set-ups to a known state.
[1]	Set-up 1	Set-up 1 [1] to Set-up 4 [4] can be edited freely during operation, independently of the active set-up.
[2]	Set-up 2	
[3]	Set-up 3	
[4]	Set-up 4	
[9] *	Active Set-up	(i.e., the set-up in which the adjustable frequency drive is operating) can also be edited during operation. Editing parameters in the chosen set-up would normally be done from the LCP but it is also possible from any of the serial communication ports.

0-12 This Set-up Linked to		
Option:	Function:	
		This parameter only needs to be programmed if changing set-ups is required while the motor is running. It ensures that parameters that are 'not changeable during operation' have the same setting in all relevant set-ups. To enable conflict-free changes from one set-up to another while the adjustable frequency drive is running, link set-ups containing parameters that are not changeable during operation. The link will ensure the proper synchronization of the 'not changeable during operation' parameter values when moving from one set-up to another during operation. 'Not changeable during operation' parameters can be identified by the label FALSE in the parameter lists in the section <i>Parameter Lists</i> . The 0-12 This Set-up Linked to feature is used when Multi set-up in 0-10 Active Set-up is selected. Multi set-up can be used to move from one set-up to another during operation (i.e., while the motor is running). Example: Use Multi set-up to shift from Set-up 1 to Set-up 2 while the motor is running. Program parameters in Set-up 1 first, then ensure that Set-up 1 and Set-up 2 are synchronized (or

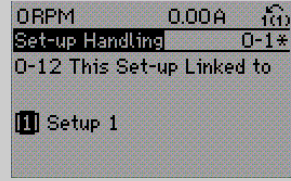
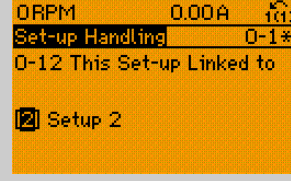
0-12 This Set-up Linked to		
Option:	Function:	
		'linked'). Synchronization can be performed in two ways: 1. Change the edit set-up to Set-up 2 [2] in 0-11 Programming Set-up and set 0-12 This Set-up Linked to to Set-up 1 [1]. This will start the linking (synchronizing) process.
		 <p>Figure 3.1</p>
		OR 2. While still in Set-up 1, using 0-50 LCP Copy, copy Set-up 1 to Set-up 2. Then set 0-12 This Set-up Linked to to Set-up 2 [2]. This will start the linking process.
		 <p>Figure 3.2</p>
		After the link is complete, 0-13 Readout: Linked Set-ups will read {1,2} to indicate that all 'not changeable during operation' parameters are now the same in Set-up 1 and Set-up 2. If there are changes to a "not changeable during operation" parameter, e.g., 1-30 Stator Resistance (Rs) in Set-up 2, they will also be changed automatically in Set-up 1. A switch between Set-up 1 and Set-up 2 during operation is now possible.
[0] *	Not linked	
[1]	Set-up 1	
[2]	Set-up 2	
[3]	Set-up 3	
[4]	Set-up 4	

0-13 Readout: Linked Set-ups														
Array [5]														
Range:	Function:													
0 * [0 - 255]	View a list of all the set-ups linked by means of 0-12 <i>This Set-up Linked to</i> . The parameter has one index for each parameter set-up. The parameter value displayed for each index represents which set-ups are linked to that parameter set-up.													
	<table border="1"> <thead> <tr> <th>Index</th> <th>LCP value</th> </tr> </thead> <tbody> <tr> <td>0</td> <td>{0}</td> </tr> <tr> <td>1</td> <td>{1,2}</td> </tr> <tr> <td>2</td> <td>{1,2}</td> </tr> <tr> <td>3</td> <td>{3}</td> </tr> <tr> <td>4</td> <td>{4}</td> </tr> </tbody> </table>	Index	LCP value	0	{0}	1	{1,2}	2	{1,2}	3	{3}	4	{4}	
Index	LCP value													
0	{0}													
1	{1,2}													
2	{1,2}													
3	{3}													
4	{4}													
<p>Table 3.2 Example: Set-up 1 and Set-up 2 are linked</p>														

0-14 Readout: Prog. Set-ups / Channel		
Range:	Function:	
0 * [-2147483648 - 2147483647]	View the setting of 0-11 <i>Programming Set-up</i> for each of the four different communication channels. When the number is displayed in hex, as it is in the LCP, each number represents one channel. Numbers 1-4 represent a set-up number; 'F' means factory setting; and 'A' means active set-up. The channels are, from right to left: LCP , FC bus, USB, HPFB1.5. Example: The number AAAAAA21h means that the FC bus selected Set-up 2 in 0-11 <i>Programming Set-up</i> , the LCP selected Set-up 1 and all others used the active set-up.	

3.2.3 0-2* LCP Display

Define the variables displayed in the Graphical Local Control Panel.

NOTE!

Please refer to 0-37 *Display Text 1*, 0-38 *Display Text 2* and 0-39 *Display Text 3* for information on how to write display texts.

0-20 Display Line 1.1 Small		
Option:	Function:	
		Select a variable for display in line 1, left position.
[0] *	None	No display value selected

0-20 Display Line 1.1 Small		
Option:	Function:	
[37]	Display Text 1	Enables an individual text string to be written, for display in the LCP or to be read via serial communication.
[38]	Display Text 2	Enables an individual text string to be written, for display in the LCP or to be read via serial communication.
[39]	Display Text 3	Enables an individual text string to be written, for display in the LCP or to be read via serial communication.
[89]	Date and Time Readout	Displays the current date and time.
[953]	Profibus Warning Word	Displays Profibus communication warnings.
[1005]	Readout Transmit Error Counter	View the number of CAN control transmission errors since the last power-up.
[1006]	Readout Receive Error Counter	View the number of CAN control receipt errors since the last power-up.
[1007]	Readout Bus Off Counter	View the number of Bus Off events since the last power-up.
[1013]	Warning Parameter	View a DeviceNet-specific warning word. One separate bit is assigned to every warning.
[1115]	LON Warning Word	Shows the LON-specific warnings.
[1117]	XIF Revision	Shows the version of the external interface file of the Neuron C chip on the LON option.
[1118]	LonWorks Revision	Shows the software version of the application program of the Neuron C chip on the LON option.
[1230]	Warning Parameter	
[1501]	Running Hours	View the number of running hours of the motor.
[1502]	kWh Counter	View the line power consumption in kWh.
[1600]	Control Word	View the control word sent from the adjustable frequency drive via the serial communication port in hex code.
[1601]	Reference [Unit]	Total reference (sum of digital/analog/preset/bus/freeze ref./catch up and slow-down) in selected unit.

0-20 Display Line 1.1 Small		
Option:	Function:	
[1602] *	Reference %	Total reference (sum of digital/analog/preset/bus/freeze ref./catch up and slow-down) in percent.
[1603]	Status Word	Present status word
[1605]	Main Actual Value [%]	View the two-byte word sent with the status word to the bus master reporting the Main Actual Value.
[1609]	Custom Readout	View the user-defined readouts as defined in <i>0-30 Custom Readout Unit</i> , <i>0-31 Custom Readout Min Value</i> and <i>0-32 Custom Readout Max Value</i> .
[1610]	Power [kW]	Actual power consumed by the motor in kW.
[1611]	Power [hp]	Actual power consumed by the motor in HP.
[1612]	Motor voltage	Voltage supplied to the motor.
[1613]	Frequency	Motor frequency, i.e., the output frequency from the adjustable frequency drive in Hz.
[1614]	Motor Current	Phase current of the motor measured as effective value.
[1615]	Frequency [%]	Motor frequency, i.e., the output frequency from the adjustable frequency drive in percent.
[1616]	Torque [Nm]	Present motor load as a percentage of the rated motor torque.
[1617]	Speed [RPM]	Motor speed reference. Actual speed will depend on slip compensation being used (compensation set in <i>1-62 Slip Compensation</i>). If not used, actual speed will be the value read in the display minus motor slip.
[1618]	Motor Thermal	Thermal load on the motor, calculated by the ETR function. See also parameter group 1-9* Motor Temperature.
[1622]	Torque [%]	Shows the actual torque produced, in percentage.
[1626]	Power Filtered [kW]	
[1627]	Power Filtered [hp]	
[1630]	DC Link Voltage	Intermediate circuit voltage in the adjustable frequency drive.

0-20 Display Line 1.1 Small		
Option:	Function:	
[1632]	Brake Energy /s	Present braking energy transferred to an external brake resistor. Stated as an instantaneous value.
[1633]	Brake Energy /2 min	Braking energy transferred to an external brake resistor. The mean power is calculated continuously for the most recent 120 seconds.
[1634]	Heatsink Temp.	Present heatsink temperature of the adjustable frequency drive. The cut-out limit is 203°F ± 9°F [95° ± 5°C]; cutting back in occurs at 158°F ± 9°F [70° ± 5°C].
[1635]	Inverter Thermal	Percentage load of the inverters
[1636]	Inv. Nom. Current	Nominal current of the adjustable frequency drive.
[1637]	Inv. Max. Current	Maximum current of the adjustable frequency drive.
[1638]	SL Controller State	State of the event executed by the control
[1639]	Control Card Temp.	Temperature of the control card.
[1643]	Timed Actions Status	See parameter group 23-0* <i>Timed Actions</i> .
[1650]	External Reference	Sum of the external reference as a percentage, i.e., the sum of analog/pulse/bus.
[1652]	Feedback [Unit]	Reference value from programmed digital input(s).
[1653]	Digi Pot Reference	View the contribution of the digital potentiometer to the actual reference Feedback.
[1654]	Feedback 1 [Unit]	View the value of Feedback 1. See also par. 20-0*.
[1655]	Feedback 2 [Unit]	View the value of Feedback 2. See also par. 20-0*.
[1656]	Feedback 3 [Unit]	View the value of Feedback 3. See also par. 20-0*.
[1658]	PID Output [%]	Returns the Drive Closed Loop PID controller output value in percent.
[1660]	Digital Input	Displays the status of the digital inputs. Signal low = 0; Signal high = 1. Regarding order, see <i>16-60 Digital Input</i> . Bit 0 is at the extreme right.

0-20 Display Line 1.1 Small		
Option:	Function:	
[1661]	Terminal 53 Switch Setting	Setting of input terminal 53. Current = 0; Voltage = 1.
[1662]	Analog Input 53	Actual value at input 53 either as a reference or protection value.
[1663]	Terminal 54 Switch Setting	Setting of input terminal 54. Current = 0; Voltage = 1.
[1664]	Analog Input 54	Actual value at input 54 either as reference or protection value.
[1665]	Analog Output 42 [mA]	Actual value at output 42 in mA. Use <i>6-50 Terminal 42 Output</i> to select the variable to be represented by output 42.
[1666]	Digital Output [bin]	Binary value of all digital outputs.
[1667]	Pulse Input #29 [Hz]	Actual value of the frequency applied at terminal 29 as a pulse input.
[1668]	Pulse Input #33 [Hz]	Actual value of the frequency applied at terminal 33 as a pulse input.
[1669]	Pulse Output #27 [Hz]	Actual value of pulses applied to terminal 27 in digital output mode.
[1670]	Pulse Output #29 [Hz]	Actual value of pulses applied to terminal 29 in digital output mode.
[1671]	Relay Output [bin]	View the setting of all relays.
[1672]	Counter A	View the present value of Counter A.
[1673]	Counter B	View the present value of Counter B.
[1675]	Analog In X30/11	Actual value of the signal on input X30/11 (General Purpose I/O Card. Option)
[1676]	Analog In X30/12	Actual value of the signal on input X30/12 (General Purpose I/O Card. Optional)
[1677]	Analog Out X30/8 [mA]	Actual value at output X30/8 (General Purpose I/O Card. Optional) Use <i>6-60 Terminal X30/8 Output</i> to select the variable to be shown.
[1680]	Fieldbus CTW 1	Control word (CTW) received from the bus master.
[1682]	Fieldbus REF 1	Main reference value sent with control word via the serial communications network, e.g., from the BMS, PLC or other master controller.

0-20 Display Line 1.1 Small		
Option:	Function:	
[1684]	Comm. Option Status	Extended serial communication option status word.
[1685]	FC Port CTW 1	Control word (CTW) received from the bus master.
[1686]	FC Port REF 1	Status word (STW) sent to the bus master.
[1690]	Alarm Word	One or more alarms in a Hex code (used for serial communications)
[1691]	Alarm word 2	One or more alarms in a Hex code (used for serial communications)
[1692]	Warning Word	One or more warnings in a Hex code (used for serial communications)
[1693]	Warning word 2	One or more warnings in a Hex code (used for serial communications)
[1694]	Ext. Status Word	One or more status conditions in a Hex code (used for serial communications)
[1695]	Ext. Status Word 2	One or more status conditions in a Hex code (used for serial communications)
[1696]	Maintenance Word	The bits reflect the status for the programmed preventive maintenance events in parameter group 23-1*
[1830]	Analog Input X42/1	Shows the value of the signal applied to terminal X42/1 on the Analog I/O card.
[1831]	Analog Input X42/3	Shows the value of the signal applied to terminal X42/3 on the Analog I/O card.
[1832]	Analog Input X42/5	Shows the value of the signal applied to terminal X42/5 on the Analog I/O card.
[1833]	Analog Out X42/7 [V]	Shows the value of the signal applied to terminal X42/7 on the Analog I/O card.
[1834]	Analog Out X42/9 [V]	Shows the value of the signal applied to terminal X42/9 on the Analog I/O card.
[1835]	Analog Out X42/11 [V]	Shows the value of the signal applied to terminal X42/11 on the Analog I/O card.
[1836]	Analog Input X48/2 [mA]	

0-20 Display Line 1.1 Small		
Option:	Function:	
[1837]	Temp. Input X48/4	
[1838]	Temp. Input X48/7	
[1839]	Temp. Input X48/10	
[1850]	Sensorless Readout [unit]	
[2117]	Ext. 1 Reference [Unit]	The value of the reference for extended Closed-loop Controller 1
[2118]	Ext. 1 Feedback [Unit]	The value of the feedback signal for extended Closed-loop Controller 1
[2119]	Ext. 1 Output [%]	The value of the output from extended Closed-loop Controller 1
[2137]	Ext. 2 Reference [Unit]	The value of the reference for extended Closed-loop Controller 2
[2138]	Ext. 2 Feedback [Unit]	The value of the feedback signal for extended Closed-loop Controller 2
[2139]	Ext. 2 Output [%]	The value of the output from extended Closed-loop Controller 2
[2157]	Ext. 3 Reference [Unit]	The value of the reference for extended Closed-loop Controller 3
[2158]	Ext. 3 Feedback [Unit]	The value of the feedback signal for extended Closed-loop Controller 3
[2159]	Ext. 3 Output [%]	The value of the output from extended Closed-loop Controller 3
[2230]	No-Flow Power	The calculated No-Flow Power for the actual operating speed
[2316]	Maintenance Text	
[2580]	Cascade Status	Status for the operation of the Cascade Controller
[2581]	Pump Status	Status for the operation of each individual pump controlled by the Cascade Controller
[3110]	Bypass Status Word	
[3111]	Bypass Running Hours	
[9913]	Idle time	
[9914]	Paramdb requests in queue	
[9920]	HS Temp. (PC1)	
[9921]	HS Temp. (PC2)	
[9922]	HS Temp. (PC3)	
[9923]	HS Temp. (PC4)	
[9924]	HS Temp. (PC5)	

0-20 Display Line 1.1 Small		
Option:	Function:	
[9925]	HS Temp. (PC6)	
[9926]	HS Temp. (PC7)	
[9927]	HS Temp. (PC8)	

0-21 Display Line 1.2 Small

Select a variable for display in line 1, middle position.

Option:	Function:	
[1614] *	Motor Current	The options are the same as those listed in <i>0-20 Display Line 1.1 Small</i> .

0-22 Display Line 1.3 Small

Select a variable for display in line 1, right position.

Option:	Function:	
[1610] *	Power [kW]	The options are the same as those listed in <i>0-20 Display Line 1.1 Small</i> .

0-23 Display Line 2 Large

Select a variable for display in line 2.

Option:	Function:	
[1613] *	Frequency	The options are the same as those listed in <i>0-20 Display Line 1.1 Small</i> .

0-24 Display Line 3 Large

Select a variable for display in line 3.

Option:	Function:	
[30121] *	Mains Frequency	The options are the same as those listed in <i>0-20 Display Line 1.1 Small</i> .

0-25 My Personal Menu

Array [20]		
Range:	Function:	
Size related*	[0 - 9999]	

3.2.4 0-3* LCP Custom Readout

It is possible to customize the display elements for various purposes: *Custom Readout. Value proportional to speed (linear, squared or cubed depending on unit selected in *0-30 Custom Readout Unit*) *Display Text. Text string stored in a parameter.

Custom Readout

The calculated value to be displayed is based on settings in *0-30 Custom Readout Unit*, *0-31 Custom Readout Min Value* (linear only), *0-32 Custom Readout Max Value*, *4-13 Motor Speed High Limit [RPM]*, *4-14 Motor Speed High Limit [Hz]* and actual speed.

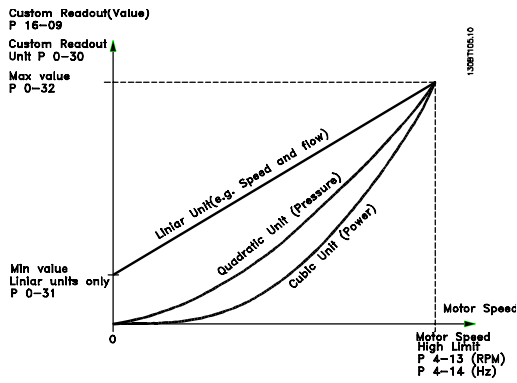

Figure 3.3

The relation will depend on the type of unit selected in 0-30 Custom Readout Unit:

Unit Type	Speed Relation
Dimensionless	Linear
Speed	
Flow, volume	
Flow, mass	
Velocity	
Length	
Temperature	
Pressure	Quadratic
Power	Cubic

Table 3.3

0-30 Custom Readout Unit	
Option:	Function:
	Program a value to be shown in the display of the LCP. The value has a linear, squared or cubed relation to speed. This relation depends on the unit selected (see Table 3.3). The actual calculated value can be read in 16-09 Custom Readout, and/or shown in the display by selecting Custom Readout [16-09] in 0-20 Display Line 1.1 Small to 0-24 Display Line 3 Large.
[0]	
[1] *	%
[5]	PPM
[10]	min
[11]	RPM
[12]	PULSE/s
[20]	liter / sec.
[21]	liter / min
[22]	liter / hr.
[23]	m ³ / sec.
[24]	m ³ /min

0-30 Custom Readout Unit	
Option:	Function:
[25]	m ³ / hr.
[30]	kg / sec.
[31]	kg/min
[32]	kg / hr.
[33]	ton / min
[34]	ton / hr.
[40]	m / sec.
[41]	m/min
[45]	m
[60]	°C
[70]	mbar
[71]	bar
[72]	Pa
[73]	kPa
[74]	m WG
[75]	mm Hg
[80]	kW
[120]	GPM
[121]	gal / sec.
[122]	gal/min
[123]	gal / hr.
[124]	CFM
[125]	ft ³ /s
[126]	ft ³ /min
[127]	ft ³ /h
[130]	lbs / sec.
[131]	lbs / min.
[132]	lbs / hr.
[140]	ft/s
[141]	ft/min
[145]	ft
[160]	°F
[170]	psi
[171]	lb/in ²
[172]	in. wtr. gage
[173]	ft WG
[174]	in Hg
[180]	HP

0-31 Custom Readout Min Value	
Range:	Function:
Size related*	[0.00 - 100.00 CustomReadoutUnit]

0-32 Custom Readout Max Value		
Range:	Function:	
100.00 Custom-ReadoutUnit*	[par. 0-31 - 999999.99 CustomReadoutUnit]	This parameter sets the max value to be shown when the speed of the motor has reached the set value for <i>4-13 Motor Speed High Limit [RPM]</i> or <i>4-14 Motor Speed High Limit [Hz]</i> (depends on setting in <i>0-02 Motor Speed Unit</i>).

0-37 Display Text 1		
Range:	Function:	
0 * [0 - 0]	In this parameter, it is possible to write an individual text string for display in the LCP or to be read via serial communication. If it is to be displayed permanently, select Display Text 1 in <i>0-20 Display Line 1.1 Small, 0-21 Display Line 1.2 Small, 0-22 Display Line 1.3 Small, 0-23 Display Line 2 Large</i> or <i>0-24 Display Line 3 Large</i> . Use the [▲] or [▼] buttons on the LCP to change a character. Use the [◀] and [▶] buttons to move the cursor. When a character is highlighted by the cursor, it can be changed. Use the [▲] or [▼] buttons on the LCP to change a character. A character can be inserted by placing the cursor between two characters and pressing [▲] or [▼].	

0-38 Display Text 2		
Range:	Function:	
0 * [0 - 0]	In this parameter, it is possible to write an individual text string for display in the LCP or to be read via serial communication. If to be displayed permanently select Display Text 2 in <i>0-20 Display Line 1.1 Small, 0-21 Display Line 1.2 Small, 0-22 Display Line 1.3 Small, 0-23 Display Line 2 Large</i> or <i>0-24 Display Line 3 Large</i> . Use the [▲] or [▼] buttons on the LCP to change a character. Use the [◀] and [▶] buttons to move the cursor. When a character is highlighted by the cursor, this character can be changed. A character can be inserted by placing the cursor between two characters and pressing [▲] or [▼].	

0-39 Display Text 3		
Range:	Function:	
0 * [0 - 0]	In this parameter, it is possible to write an individual text string for display in the LCP or to be read via serial communication. If it is to be displayed permanently, select Display Text 3 in <i>0-20 Display Line 1.1 Small, 0-21 Display Line 1.2 Small, 0-22 Display Line 1.3 Small, 0-23 Display Line 2 Large</i> or <i>0-24 Display Line 3 Large</i> . Use the [▲] or [▼] buttons	

0-39 Display Text 3		
Range:	Function:	
	on the LCP to change a character. Use the [◀] and [▶] buttons to move the cursor. When a character is highlighted by the cursor, this character can be changed. A character can be inserted by placing the cursor between two characters and pressing [▲] or [▼].	

3.2.5 0-4* LCP Keypad

Enable, disable and password protect individual keys on the LCP.

0-40 [Hand on] Key on LCP		
Option:	Function:	
[0]	Disabled	No function
[1] *	Enabled	[Hand on] Key enabled
[2]	Password	Avoid unauthorized start in hand mode. If <i>0-40 [Hand on] Key on LCP</i> is included in the My Personal Menu, then define the password in <i>0-65 Personal Menu Password</i> . Otherwise, define the password in <i>0-60 Main Menu Password</i> .
[3]	Enabled without OFF	
[4]	Password w/out OFF	
[5]	Enabled with OFF	
[6]	Password with OFF	

0-41 [Off] Key on LCP		
Option:	Function:	
[0]	Disabled	No function
[1] *	Enabled	[Off] Key is enabled
[2]	Password	Avoid unauthorized stop. If <i>0-41 [Off] Key on LCP</i> is included in the My Personal Menu, then define the password in <i>0-65 Personal Menu Password</i> . Otherwise, define the password in <i>0-60 Main Menu Password</i> .
[3]	Enabled without OFF	
[4]	Password w/out OFF	
[5]	Enabled with OFF	
[6]	Password with OFF	

0-42 [Auto on] Key on LCP		
Option:	Function:	
[0]	Disabled	No function
[1] *	Enabled	[Auto on] Key is enabled
[2]	Password	Avoid unauthorized start in auto mode. If 0-42 [Auto on] Key on LCP is included in the My Personal Menu, then define the password in 0-65 Personal Menu Password. Otherwise, define the password in 0-60 Main Menu Password.
[3]	Enabled without OFF	
[4]	Password w/out OFF	
[5]	Enabled with OFF	
[6]	Password with OFF	

0-43 [Reset] Key on LCP		
Option:	Function:	
[0]	Disabled	No function
[1] *	Enabled	[Reset] Key is enabled
[2]	Password	Avoid unauthorized resetting. If 0-43 [Reset] Key on LCP is included in the 0-25 My Personal Menu, then define the password in 0-65 Personal Menu Password. Otherwise, define the password in 0-60 Main Menu Password.
[3]	Enabled without OFF	
[4]	Password w/out OFF	
[5]	Enabled with OFF	
[6]	Password with OFF	

3.2.6 0-5* Copy/Save

Copy parameter settings between set-ups and to/from the LCP.

0-50 LCP Copy		
Option:	Function:	
[0] *	No copy	No function
[1]	All to LCP	Copies all parameters in all set-ups from the adjustable frequency drive memory to the LCP memory. For service purposes it is recommended to copy all parameters to the LCP after commissioning.
[2]	All from LCP	Copies all parameters in all set-ups from the LCP memory to the adjustable frequency drive memory.

0-50 LCP Copy		
Option:	Function:	
[3]	Size indep. of LCP	Copies only the parameters that are independent of the motor size. The latter selection can be used to program several adjustable frequency drives with the same function without disturbing motor data that are already set.

This parameter cannot be adjusted while the motor is running.

0-51 Set-up Copy		
Option:	Function:	
[0] *	No copy	No function
[1]	Copy to set-up 1	Copies all parameters in the present Programming Set-up (defined in 0-11 Programming Set-up) to Set-up 1.
[2]	Copy to set-up 2	Copies all parameters in the present Programming Set-up (defined in 0-11 Programming Set-up) to Set-up 2.
[3]	Copy to set-up 3	Copies all parameters in the present Programming Set-up (defined in 0-11 Programming Set-up) to Set-up 3.
[4]	Copy to set-up 4	Copies all parameters in the present Programming Set-up (defined in 0-11 Programming Set-up) to Set-up 4.
[9]	Copy to all	Copies the parameters in the present set-up over to each of the set-ups 1 to 4.

3.2.7 0-6* Password

0-60 Main Menu Password		
Range:	Function:	
100 *	[0 - 999]	Define the password for access to the main menu via the [Main Menu] key. If 0-61 Access to Main Menu w/o Password is set to Full access [0], this parameter will be ignored.

0-61 Access to Main Menu w/o Password		
Option:	Function:	
[0] *	Full access	Disables password defined in 0-60 Main Menu Password.
[1]	Read-only	Prevent unauthorized editing of main menu parameters.
[2]	No access	Prevent unauthorized viewing and editing of main menu parameters.

If Full access [0] is selected then 0-60 Main Menu Password, 0-65 Personal Menu Password and 0-66 Access to Personal Menu w/o Password will be ignored.

0-65 Personal Menu Password		
Range:	Function:	
200 *	[0 - 999]	Define the password for access to the My Personal Menu via the [Quick Menu] key. If 0-66 Access to Personal Menu w/o Password is set to Full access [0], this parameter will be ignored.

0-66 Access to Personal Menu w/o Password		
Option:	Function:	
[0] *	Full access	Disables password defined in 0-65 Personal Menu Password.
[1]	Read-only	Prevents unauthorized editing of My Personal Menu parameters.
[2]	No access	Prevents unauthorized viewing and editing of My Personal Menu parameters.

If 0-61 Access to Main Menu w/o Password is set to Full access [0], this parameter will be ignored.

3.2.8 0-7* Clock Settings

Set the time and date of the internal clock. The internal clock can be used, for example, for timed actions, energy log, trend analysis, date/time stamps on alarms, logged data and preventive maintenance.

It is possible to program the clock for Daylight Saving Time/summertime, weekly working days/non-working days including 20 exceptions (holidays, etc.). Although the clock settings can be set via the LCP, they can also be set along with timed actions and preventative maintenance functions using the MCT 10 software tool.

NOTE!

The adjustable frequency drive has no backup of the clock function and the set date/time will reset to default (2000-01-01 00:00) after a power-down unless a real time clock module with backup is installed. If no module with backup is installed, it is recommended the clock function is only used if the adjustable frequency drive is integrated into the BMS using serial communications, with the BMS maintaining synchronization of control equipment clock times. In 0-79 Clock Fault, it is possible to program for a warning in case the clock has not been set properly, e.g., after a power-down.

NOTE!

If mounting an Analog I/O MCB 109 option card, a battery backup of the date and time is included.

0-70 Date and Time		
Range:	Function:	
Size related*	[0 - 0]	Sets the date and time of the internal clock. The format to be used is set in 0-71 Date Format and 0-72 Time Format.

0-71 Date Format		
Option:	Function:	
		Sets the date format to be used in the LCP.
[0] *	YYYY-MM-DD	
[1] *	DD-MM-YYYY	
[2]	MM/DD/YYYY	

0-72 Time Format		
Option:	Function:	
		Sets the time format to be used in the LCP.
[0] *	24 h	
[1]	12 h	

0-74 DST/Summertime		
Option:	Function:	
		Choose how Daylight Saving Time/Summertime should be handled. For manual DST/Summertime enter the start date and end date in 0-76 DST/Summertime Start and 0-77 DST/Summertime End.
[0] *	OFF	
[2]	Manual	

0-76 DST/Summertime Start		
Range:	Function:	
Size related*	[0 - 0]	

0-77 DST/Summertime End		
Range:	Function:	
Size related*	[0 - 0]	

0-79 Clock Fault		
Option:	Function:	
		Enables or disables the clock warning when the clock has not been set, or has been reset due to a power-down and no backup is installed. If MCB 109 is installed "enabled" is default
[0] *	Disabled	
[1]	Enabled	

0-81 Working Days		
Array with 7 elements [0] - [6] displayed below parameter number in display. Press OK and step between elements by means of ▲ and ▼ buttons on the LCP.		
Option:		Function:
		Specify whether each weekday is a workday or a non-workday. First element of the array is Monday. The workdays are used for timed actions.
[0] *	No	
[1]	Yes	

0-82 Additional Working Days		
Array with 5 elements [0] - [4] displayed below parameter number in display. Press OK and step between elements by means of ▲ and ▼ buttons on the LCP.		
Range:		Function:
Size related*	[0 - 0]	

0-83 Additional Non-Working Days		
Array with 15 elements [0] - [14] displayed below parameter number in display. Press OK and step between elements by means of ▲ and ▼ buttons on the LCP.		
Range:		Function:
Size related*	[0 - 0]	

0-89 Date and Time Readout		
Range:		Function:
0 *	[0 - 0]	Displays the current date and time. The date and time is updated continuously. The clock will not begin counting until a setting different from default has been made in <i>0-70 Date and Time</i> .

3.3 Main Menu - Load and Motor - Group 1

3.3.1 1-0* General Settings

Define whether the Adjustable frequency drive operates in open-loop or closed-loop.

1-00 Configuration Mode	
Option:	Function:
[0] *	Open-loop Motor speed is determined by applying a speed reference or by setting desired speed when in Hand Mode. Open-loop is also used if the Adjustable frequency drive is part of a closed-loop control system based on an external PID controller providing a speed reference signal as output.
[3]	Closed-loop Motor speed will be determined by a reference from the built-in PID controller varying the motor speed as part of a closed-loop control process (e.g., constant pressure or flow). The PID controller must be configured in parameter group 20-** or via the Function Setups accessed by pressing the [Quick Menus] button.

NOTE!

This parameter cannot be changed while the motor is running.

NOTE!

When set for Closed-Loop, the commands Reversing and Start Reversing will not reverse the direction of the motor.

1-03 Torque Characteristics	
Option:	Function:
[0] *	Compressor torque <i>Compressor</i> [0]: For speed control of screw and scroll compressors. Provides a voltage which is optimized for a constant torque load characteristic of the motor in the entire range down to 10 Hz.
[1]	Variable torque <i>Variable Torque</i> [1]: For speed control of centrifugal pumps and fans. Also to be used when controlling more than one motor from the same Adjustable frequency drive (e.g., multiple condenser fans or cooling tower fans). Provides a voltage which is optimized for a squared torque load characteristic of the motor.
[2]	Auto Energy Optim. CT <i>Auto Energy Optimization Compressor</i> [2]: For optimum energy efficient speed control of screw and scroll compressors. Provides a voltage that is optimized for a constant torque load characteristic of the motor in the

1-03 Torque Characteristics	
Option:	Function:
	entire range down to 15 Hz. In addition, the AEO feature will adapt the voltage exactly to the current load situation, thereby reducing energy consumption and audible noise from the motor. To obtain optimal performance, the motor power factor cos phi must be set correctly. This value is set in <i>14-43 Motor Cos-Phi</i> . The parameter has a default value which is automatically adjusted when the motor data is programmed. These settings will typically ensure optimum motor voltage but if the motor power factor cos phi requires tuning, an AMA function can be carried out using <i>1-29 Automatic Motor Adaptation (AMA)</i> . It is very rarely necessary to adjust the motor power factor parameter manually.
[3] *	Auto Energy Optim. VT <i>Auto Energy Optimization VT</i> [3]: For optimum energy efficient speed control of centrifugal pumps and fans. Provides a voltage which is optimized for a squared torque load characteristic of the motor but in addition the AEO feature will adapt the voltage exactly to the current load situation, thereby reducing energy consumption and audible noise from the motor. To obtain optimal performance, the motor power factor cos phi must be set correctly. This value is set in <i>14-43 Motor Cos-Phi</i> . The parameter has a default value and is automatically adjusted when the motor data is programmed. These settings will typically ensure optimum motor voltage but if the motor power factor cos phi requires tuning, an AMA function can be carried out using <i>1-29 Automatic Motor Adaptation (AMA)</i> . It is very rarely necessary to adjust the motor power factor parameter manually.

NOTE!

1-03 Torque Characteristics will not have effect when *1-10 Motor Construction* = [1] PM, non-salient SPM.

NOTE!

For pumps or fan applications where the viscosity or density can vary significantly or where excessive flow, e.g., due to pipe breakage can occur, it is recommended to select Auto Energy Optim. CT.

1-06 Clockwise Direction		
This parameter defines the term “Clockwise” corresponding to the LCP direction arrow. Used for easy change of direction of shaft rotation without swapping motor wires. (Valid from SW version 5.84)		
Option:		Function:
[0] *	Normal	Motor shaft will turn in clockwise direction when the Adjustable frequency drive is connected U -> U; V -> V, and W -> W to motor.
[1]	Inverse	Motor shaft will turn in counter clockwise direction when the Adjustable frequency drive is connected U -> U; V -> V, and W -> W to motor.

NOTE!

This parameter cannot be changed while the motor is running.

3.3.2 1-10 - 1-13 Motor Selection

NOTE!

This parameter group cannot be adjusted while the motor is running.

The following parameters are active ('x') depending on the setting of 1-10 Motor Construction

1-10 Motor construction	[0] Asynchron	[1] PM Motor non-salient
1-00 Configuration mode	x	x
1-03 Torque Characteristics	x	
1-06 Clockwise direction	x	x
1-14 Damping gain		x
1-15 High pass filter damp time low speed		x
1-16 High pass filter damp time high speed		x
1-17 Machine voltage filter time		x
1-20 Motor power [KW]	x	
1-21 - Motor power [HP]	x	
1-22 Motor Voltage	x	
1-23 Motor frequency	x	
1-24 Motor current	x	x
1-25 Motor Nom. speed	x	x
1-26 Motor rated torque		x
1-28 Motor rotation check	x	x
1-29 AMA	x	
1-30 RS	x	x
1-31 Rr	x	

1-10 Motor construction	[0] Asynchron	[1] PM Motor non-salient
1-35 Xh	x	
1-37 Ld		x
1-38 Lq		
1-39 Motor poles	x	x
1-40 Back EMF		x
1-50 Motor Magnet. at 0 speed	x	
1-51 Min Speed norm. magnet [rpm]	x	
1-52 Min Speed norm. magnet [Hz]	x	
1-58 Flystart test pulses current	x	x
1-59 Flystart test pulses frequency	x	x
1-60 Low Speed Load Compensation	x	
1-61 High Speed Load Compensation	x	
1-62 Slip Compensation	x	
1-63 Slip Compensation time const.	x	
1-64 Resonance Damping	x	
1-65 Resonance Damping time const.	x	
1-66 Min Current at low speed		x
1-70 PM Start mode		x
1-71 Start Delay	x	x
1-72 Start Function	x	x
1-73 Flying Start	x	x
1-77 Compressor Max Start speed [rpm]	x	
1-78 Compressor Max Start speed [Hz]	x	
1-79 Compressor start max time to trip	x	
1-80 Stop Function	x	x
1-81 Min Speed funct. at stop [rpm]	x	x
1-82 Min Speed funct. at stop [Hz]	x	x
1-86 Trip speed low [rpm]	x	x
1-87 Trip speed low [Hz]	x	x
1-90 Motor Thermal Protection	x	x
1-91 Motor External Fan	x	x
1-93 Thermistor Resource	x	x
2-00 DC Hold current	x	
2-01 DC Brake current	x	x
2-02 DC Braking Time	x	
2-03 DC Brake Cut-In Speed [rpm]	x	
2-04 DC Brake Cut-in Speed [Hz]	x	
2-06 Parking Current		x
2-07 Parking Time		x
2-10 Brake Function	x	x
2-11 Brake Resistor	x	x
2-12 Braking Energy Limit	x	x
2-13 Braking Energy Monitoring	x	x
2-15 Brake Check	x	x
2-16 AC Brake Max Current	x	

1-10 Motor construction	[0] Asynchron	[1] PM Motor non-salient
2-17 Over-voltage Control	x	
4-10 Motor speed direction	x	x
4-11 Motor speed low limit [rpm]	x	x
4-12 Motor speed low limit [Hz]	x	x
4-13 Motor speed high limit [rpm]	x	x
4-14 Motor speed high limit [Hz]	x	x
4-16 Torque limit motor mode	x	x
4-17 Torque limit generator mode	x	x
4-18 Current limit	x	x
4-19 Max output frequency	x	x
4-58 Missing motor phase	x	
14-40 VT Level	x	
14-41 AEO Minimum Magnetization	x	
14-42 Minimum AEO Frequency	x	
14-43 Motor Cos phi	x	

Table 3.4

1-10 Motor Construction		
Select the motor construction type.		
Option:	Function:	
[0] *	Asynchron	For asynchronous motors.
[1]	PM, non salient SPM	For permanent magnet (PM) motors. Note that PM motors are divided into two groups, with either surface mounted (non-salient) or interior (salient) magnets. NOTE! Only available up to 22 kW motor power.

NOTE!

Motor construction can either be asynchronous or permanent magnet (PM) motor.

3.3.3 1-14 - 1-17 VVC^{plus} PM

The default control parameters for VVC^{plus} PMSM control core are optimized for HVAC applications and inertia load in range of $50 > J_l/J_m > 5$, where J_l is load inertia from the application and J_m is machine inertia.

For low inertia applications $J_l/J_m < 5$ it is recommended that 1-17 Voltage filter time const. be increased with a factor of 5–10 and in some cases 1-14 Damping Gain should also be reduced to improve performance and stability.

For High inertia applications $J_l/J_m \gg 50$, it is recommended that 1-15 Low Speed Filter Time Const., 1-16 High Speed Filter Time Const. and 1-14 Damping Gain be increased to improve performance and stability.

For high load at low speed [$< 30\%$ of rated speed] it is recommended that 1-17 Voltage filter time const. is increased due to non-linearity in the inverter at low speed.

1-14 Damping Gain		
Range:	Function:	
120 %*	[0 - 250 %]	

1-15 Low Speed Filter Time Const.		
Range:	Function:	
Size related*	[0.01 - 20.00 s]	High pass-filter damping time constant determines the response time to load steps. Obtain quick control through a short damping time constant. However, if this value is too short, the control becomes unstable. This time constant is used below 10% rated speed.

1-16 High Speed Filter Time Const.		
Range:	Function:	
Size related*	[0.01 - 20.00 s]	High pass-filter damping time constant determines the response time to load steps. Obtain quick control through a short damping time constant. However, if this value is too short, the control becomes unstable. This time constant is used above 10% rated speed.

1-17 Voltage filter time const.		
Range:	Function:	
Size related*	[0.001 - 1.000 s]	Machine Supply Voltage Filter Time constant is used for reducing the influence of high frequency ripples and system resonances in the calculation of machine supply voltage. Without this filter, the ripples in the currents can distort the calculated voltage and affects the stability of the system.

3.3.4 1-2* Motor Data

Parameter group 1-2* comprises input data from the nameplate on the connected motor.

NOTE!

Changing the value of these parameters affects the setting of other parameters.

NOTE!

1-20 Motor Power [kW], 1-21 Motor Power [HP], 1-22 Motor Voltage and 1-23 Motor Frequency will not have effect when 1-10 Motor Construction = [1] PM, non-salient SPM.

1-20 Motor Power [kW]		
Range:		Function:
Size related*	[0.09 - 3000.00 kW]	Enter the nominal motor power in kW according to the motor nameplate data. The default value corresponds to the nominal rated output of the unit. This parameter cannot be adjusted while the motor is running. Depending on the choices made in 0-03 Regional Settings, either 1-20 Motor Power [kW] or 1-21 Motor Power [HP] is made invisible.

1-21 Motor Power [HP]		
Range:		Function:
Size related*	[0.09 - 3000.00 hp]	Enter the nominal motor power in HP according to the motor nameplate data. The default value corresponds to the nominal rated output of the unit. This parameter cannot be adjusted while the motor is running. Depending on the choices made in 0-03 Regional Settings, either 1-20 Motor Power [kW] or 1-21 Motor Power [HP] is made invisible.

1-22 Motor Voltage		
Range:		Function:
Size related*	[10. - 1000. V]	

1-23 Motor Frequency		
Range:		Function:
Size related*	[20 - 1000 Hz]	Select the motor frequency value from the motor nameplate data. For 87Hz operation with 230/400 V motors, set the nameplate data for 230V/50Hz. Adapt 4-13 Motor Speed High Limit [RPM] and 3-03 Maximum Reference to the 87Hz application.

NOTE!

This parameter cannot be changed while the motor is running.

1-24 Motor Current		
Range:		Function:
Size related*	[0.10 - 10000.00 A]	Enter the nominal motor current value from the motor nameplate data. This data is used for calculating motor torque, motor thermal protection, etc.

NOTE!

This parameter cannot be changed while the motor is running.

1-25 Motor Nominal Speed		
Range:		Function:
Size related*	[100 - 60000 RPM]	Enter the nominal motor speed value from the motor nameplate data. This data is used for calculating automatic motor compensations.

NOTE!

This parameter cannot be changed while the motor is running.

1-26 Motor Cont. Rated Torque		
Range:		Function:
Size related*	[0.1 - 10000.0 Nm]	Enter the value from the motor nameplate data. The default value corresponds to the nominal rated output. This parameter is available when 1-10 Motor Construction is set to PM, non-salient SPM [1], i.e., the parameter is valid for PM and non-salient SPM motors only.

1-28 Motor Rotation Check		
Option:	Function:	
		Following installation and connection of the motor, this function allows the correct motor rotation direction to be verified. Enabling this function overrides any bus commands or digital inputs, except External Interlock and Safe Stop (if included).
[0] *	OFF	Motor Rotation Check is not active.
[1]	Enabled	Motor Rotation Check is enabled. Once enabled, display shows: "Please Note! Motor may run in wrong direction".

Pressing [OK], [Back] or [Cancel] will dismiss the message and display a new message: "Press [Hand on] to start the motor. Press [Cancel] to abort". Pressing [Hand on] starts

the motor at 5 Hz in forward direction and the display shows: "Motor is running. Check if motor rotation direction is correct. Press [Off] to stop the motor". Pressing [Off] stops the motor and resets 1-28 Motor Rotation Check. If motor rotation direction is incorrect, two motor phase cables should be interchanged.

⚠ WARNING

Line power must be removed before disconnecting motor phase cables.

1-29 Automatic Motor Adaptation (AMA)		
Option:	Function:	
		The AMA function optimizes dynamic motor performance by automatically optimizing the advanced motor 1-30 Stator Resistance (R_s) to 1-35 Main Reactance (X_h) while the motor is stationary.
[0] *	Off	No function
[1]	Enable complete AMA	Performs AMA of the stator resistance R_s , the rotor resistance R_r , the stator leakage reactance X_1 , the rotor leakage reactance X_2 and the main reactance X_h .
[2]	Enable reduced AMA	Performs a reduced AMA of the stator resistance R_s in the system only. Select this option if an LC filter is used between the Adjustable frequency drive and the motor.

NOTE!

1-29 Automatic Motor Adaptation (AMA) will not have effect when 1-10 Motor Construction = [1] PM, non-salient SPM.

Activate the AMA function by pressing [Hand on] after selecting [1] or [2]. See also the item *Automatic Motor Adaptation* in the Design Guide. After a normal sequence, the display will read: "Press [OK] to finish AMA". After pressing the [OK] key, the Adjustable frequency drive is ready for operation.

NOTE!

- For the best adaptation of the Adjustable frequency drive, run AMA on a cold motor
- AMA cannot be performed while the motor is running

NOTE!

Avoid generating external torque during AMA.

NOTE!

If one of the settings in parameter group 1-2* Motor Data is changed, 1-30 Stator Resistance (R_s) to 1-39 Motor Poles, the advanced motor parameters, will return to default setting.

This parameter cannot be adjusted while the motor is running.

NOTE!

Full AMA should be run without filter only while reduced AMA should be run with filter.

See section: *Application Examples > Automatic Motor Adaptation* in the Design Guide.

3.3.5 1-3* Adv. Motor Data

Parameters for advanced motor data. The motor data in 1-30 Stator Resistance (R_s) to 1-39 Motor Poles must match the relevant motor in order to run the motor optimally. The default settings are figures based on common motor parameter values from normal standard motors. If the motor parameters are not set correctly, a malfunction of the adjustable frequency drive system may occur. If the motor data is not known, running an AMA (Automatic Motor Adaptation) is recommended. See the *Automatic Motor Adaptation* section. The AMA sequence will adjust all motor parameters except the moment of inertia of the rotor and the iron loss resistance (1-36 Iron Loss Resistance (R_{fe})).

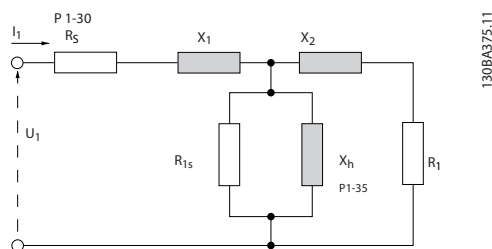
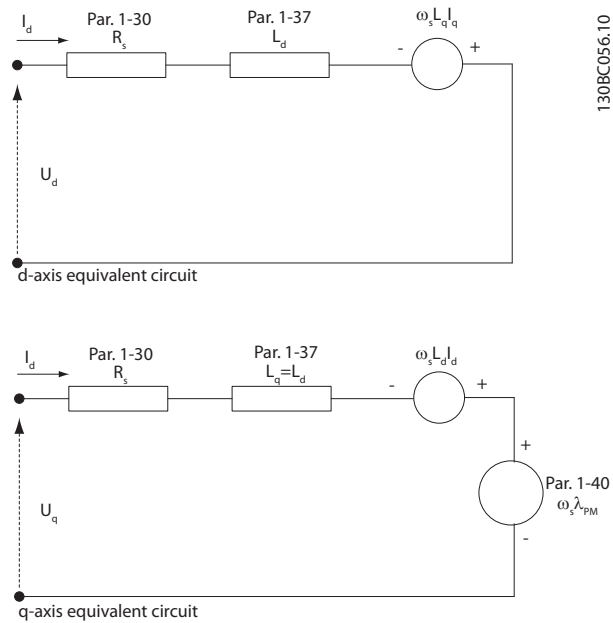

Figure 3.4 Motor Equivalent Diagram for an Asynchronous Motor



1308C056.10

Figure 3.5 Motor Equivalent Circuit Diagram for a PM Non-salient Motor

1-30 Stator Resistance (Rs)		
Range:		Function:
Size related*	[0.0140 - 140.0000 Ohm]	Set the stator resistance value. Enter the value from a motor data sheet or perform an AMA on a cold motor. This parameter cannot be adjusted while the motor is running.

1-31 Rotor Resistance (Rr)		
Range:		Function:
Size related*	[0.0100 - 100.0000 Ohm]	Fine-tuning R _r will improve shaft performance. Set the rotor resistance value using one of these methods: <ol style="list-style-type: none"> Run an AMA on a cold motor. The Adjustable frequency drive will measure the value from the motor. All compensations are reset to 100%. Enter the R_r value manually. Obtain the value from the motor supplier. Use the R_r default setting. The Adjustable frequency drive establishes the setting on the basis of the motor nameplate data.

NOTE!

1-31 Rotor Resistance (Rr) will not have effect when 1-10 Motor Construction = [1] PM, non-salient SPM.

1-35 Main Reactance (Xh)		
Range:		Function:
Size related*	[1.0000 - 10000.0000 Ohm]	Set the main reactance of the motor using one of these methods: <ol style="list-style-type: none"> Run an AMA on a cold motor. The Adjustable frequency drive will measure the value from the motor. Enter the X_h value manually. Obtain the value from the motor supplier. Use the X_h default setting. The Adjustable frequency drive establishes the setting on the basis of the motor nameplate data.

NOTE!

1-35 Main Reactance (Xh) will not have effect when 1-10 Motor Construction = [1] PM, non-salient SPM.

NOTE!

This parameter cannot be adjusted while running.

1-36 Iron Loss Resistance (Rfe)		
Range:		Function:
Size related*	[0 - 10000.000 Ohm]	

NOTE!

This parameter cannot be adjusted while the motor is running.

NOTE!

This parameter is not available from the LCP.

1-37 d-axis Inductance (Ld)		
Range:		Function:
Size related*	[0.000 - 0.000 mH]	Enter the value of the d-axis inductance. Obtain the value from the permanent magnet motor data sheet.

NOTE!

This parameter is only active when *1-10 Motor Construction* has the value *PM, non-salient SPM [1]* (Permanent Magnet Motor).

Stator resistance and d-axis Inductance values are normally, for asynchronous motors, described in technical specifications as between line and common (starpoint). For permanent magnet motors, they are typically described in technical specifications as between Line-Line. PM motors are typically built for star connection.

1-30 Stator Resistance (Rs) (Line to common)	This parameter gives stator winding resistance (Rs) Similar to Asynchronous Motor Stator resistance. The Stator resistance is defined for line to common measurement. That means for line-line data (Where stator resistance is measured between any two lines you need to divide it with 2).
1-37 d-axis Inductance (Ld) (Line to common)	This parameter gives direct axis inductance of the PM motor. The d-axis inductance is defined for phase to common measurement. That means for line-line data (Where stator resistance is measured between any two lines you need to divide it with 2)
1-40 Back EMF at 1000 RPM RMS (Line to Line Value)	This parameter gives back EMF across stator terminal of PM Motor at 1,000 rpm mechanical speed specifically. It is defined between line to line and expressed in an RMS Value.

Table 3.5

NOTE!

Motor manufacturers provide values for Stator resistance (*1-30 Stator Resistance (Rs)*) and d-axis Inductance (*1-37 d-axis Inductance (Ld)*) in technical specifications as between line and common (starpoint) or between Line-Line. There is no general standard. The different setups for Stator Winding Resistance and Induction are shown in *Figure 3.6*. Danfoss inverters always require the line to common value. The back EMF of PM motor is defined as 'Induced EMF developed across any of two phases of stator winding of free running Motor'. Danfoss inverters always require the Line to Line RMS value measured at 1,000 rpm, mechanical speed of rotation. This is shown in *Figure 3.7*

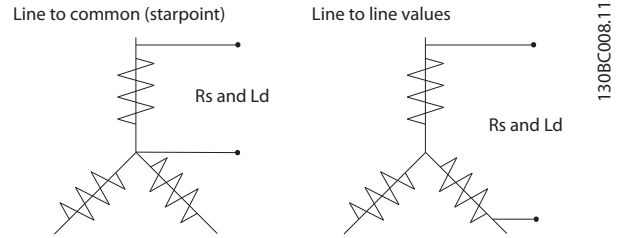

Figure 3.6 Motor parameters are provided in different formats. Danfoss adjustable frequency drives always require the line to common value.

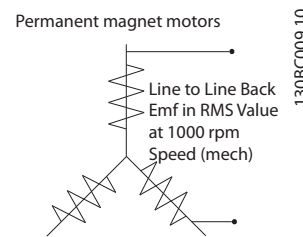

Figure 3.7 Machine parameter definitions of Back EMF of permanent magnet motors

1-39 Motor Poles		
Range:	Function:	
Size related* [2 - 100]	Enter the number of motor poles.	
	Poles	~n_n@ 50Hz ~n_n@60Hz
	2	2700–2880 3250–3460
	4	1350–1450 1625–1730
	6	700–960 840–1153
	Table 3.7	
	The table shows the number of poles for normal speed ranges of various motor types. Define motors designed for other frequencies separately. The motor pole value is always an even number, because it refers to the total number of poles, not pairs of poles. The Adjustable frequency drive creates the initial setting of 1-39 Motor Poles based on 1-23 Motor Frequency Motor Frequency and 1-25 Motor Nominal Speed Motor Nominal Speed.	
	This parameter cannot be adjusted while the motor is running.	

1-40 Back EMF at 1000 RPM		
Range:		Function:
Size related*	[10. - 9000 V]	Set the nominal back EMF for the motor when running at 1,000 RPM. This parameter is only active when <i>1-10 Motor Construction</i> is set to PM motor [1] (Permanent Magnet Motor).

3.3.6 1-5* Load Indep. Setting

1-50 Motor Magnetization at Zero Speed		
Range:		Function:
100 %*	[0 - 300 %]	

NOTE!

1-50 Motor Magnetization at Zero Speed will not have effect when *1-10 Motor Construction* = [1] PM, non-salient SPM.

1-51 Min Speed Normal Magnetizing [RPM]		
Range:		Function:
Size related*	[10 - 300 RPM]	Set the required speed for normal magnetizing current. If the speed is set lower than the motor slip speed, <i>1-50 Motor Magnetization at Zero Speed</i> and <i>1-51 Min Speed Normal Magnetizing [RPM]</i> are of no significance. Use this parameter along with <i>1-50 Motor Magnetization at Zero Speed</i> . See Table 3.7.

NOTE!

1-51 Min Speed Normal Magnetizing [RPM] will not have effect when *1-10 Motor Construction* = [1] PM, non-salient SPM.

1-52 Min Speed Normal Magnetizing [Hz]		
Range:		Function:
Size related*	[0.3 - 10.0 Hz]	Set the required frequency for normal magnetizing current. If the frequency is set lower than the motor slip frequency, <i>1-50 Motor Magnetization at Zero Speed</i> and <i>1-51 Min Speed Normal Magnetizing [RPM]</i> are inactive. Use this parameter along with <i>1-50 Motor Magnetization at Zero Speed</i> . See Table 3.7.

NOTE!

1-52 Min Speed Normal Magnetizing [Hz] will not have effect when *1-10 Motor Construction* = [1] PM, non-salient SPM.

1-58 Flystart Test Pulses Current		
Range:		Function:
Size related*	[0 - 0. %]	Set the magnitude of the magnetizing current for the pulses used to detect the motor direction. The value range and function depends on parameter <i>1-10 Motor Construction</i> : [0] Asynchron: [0-200%] Reducing this value will reduce the generated torque. 100% means full nominal motor current. In this case, the default value is 30%. [1] PM non-salient: [0-40%] A general setting of 20% is recommended on PM motors. Higher values can give increased performance. However, on motors with back EMF higher than 300VLL (rms) at nominal speed and high winding inductance (more than 10mH) a lower value is recommended to avoid wrong speed estimation. The parameter is active when <i>1-73 Flying Start</i> is enabled.

NOTE!

See description of *1-70 PM Start Mode* for an overview of the relation between the PM Flying Start parameters.

1-59 Flystart Test Pulses Frequency		
Range:		Function:
Size related*	[0 - 0. %]	The parameter is active when <i>1-73 Flying Start</i> is enabled. The value range and function depends on parameter <i>1-10 Motor Construction</i> : [0] Asynchron: [0-500%] Control the percentage of the frequency for the pulses used to detect the motor direction. Increasing this value will reduce the generated torque. In this mode, 100% means 2 times the slip frequency. [1] PM non-salient: [0-10%] This parameter defines the motor speed (in % of nominal motor speed) below which the Parking function (see <i>2-06 DC Brake Current</i> and <i>2-07 DC Braking Time</i>) will become active. This parameter is only active when <i>1-70 PM Start Mode</i> is set to [1] Parking and only after starting the motor.

NOTE!

Do NOT set this parameter too high in high inertia applications.

3.3.7 1-6* Load Depend. Setting

1-60 Low Speed Load Compensation		
Range:		Function:
100 %*	[0 - 300 %]	

3

NOTE!

1-60 Low Speed Load Compensation will not have effect when 1-10 Motor Construction = [1] PM, non-salient SPM.

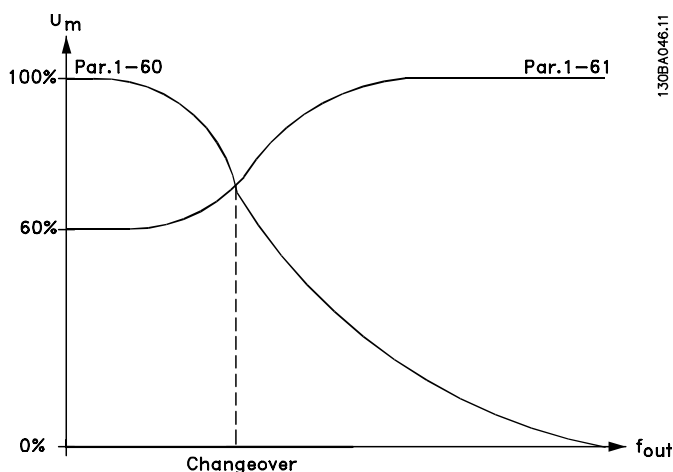

Figure 3.9

130BA046.11

1-64 Resonance Dampening

Range:		Function:
100 %*	[0 - 500 %]	

NOTE!

1-64 Resonance Dampening will not have effect when 1-10 Motor Construction = [1] PM, non-salient SPM.

1-65 Resonance Dampening Time Constant

Range:		Function:
5 ms*	[5 - 50 ms]	Set 1-64 Resonance Dampening and 1-65 Resonance Dampening Time Constant to help eliminate high-frequency resonance problems. Enter the time constant that provides the best dampening.

NOTE!

1-65 Resonance Dampening Time Constant will not have effect when 1-10 Motor Construction = [1] PM, non-salient SPM.

1-61 High Speed Load Compensation

Range:		Function:
100 %*	[0 - 300 %]	

NOTE!

1-61 High Speed Load Compensation will not have effect when 1-10 Motor Construction = [1] PM, non-salient SPM.

1-62 Slip Compensation

Range:		Function:
0 %*	[-500 - 500 %]	

NOTE!

1-62 Slip Compensation will not have effect when 1-10 Motor Construction = [1] PM, non-salient SPM.

1-63 Slip Compensation Time Constant

Range:		Function:
Size related*	[0.05 - 5.00 s]	Enter the slip compensation reaction speed. A high value results in slow reaction, and a low value results in quick reaction. If low-frequency resonance problems arise, use a longer time setting.

NOTE!

1-63 Slip Compensation Time Constant will not have effect when 1-10 Motor Construction = [1] PM, non-salient SPM.

1-66 Min. Current at Low Speed

Range:		Function:
Size related*	[1. - 200. %]	Enter the minimum motor current at low speed. Increasing this current improves developed motor torque at low speed. Low speed is defined here as speeds below 6% of the Nominal Speed of Motor (1-25 Motor Nominal Speed) in VVC ^{plus} PM Control

NOTE!

1-66 will not have affect if 1-10 = [0]

3.3.8 1-7* Start Adjustments

1-70 PM Start Mode

Option:	Function:
[0] Rotor Detection	Suitable for all applications where the motor is known to be standing still when starting (e.g., conveyors, pumps and non-windmilling fans).
[1] Parking	If the motor turns at a slight speed (i.e., lower than 2–5% of the nominal speed), e.g., due to fans with light windmilling, select [1] Parking and adjust 2-06 DC Brake Current and 2-07 DC Braking Time accordingly.

1-71 Start Delay		
Range:		Function:
0.0 s*	[0.0 - 120.0 s]	The function selected in <i>1-80 Function at Stop</i> is active in the delay period. Enter the time delay required before commencing acceleration.

1-72 Start Function		
Option:		Function:
		Select the start function during start delay. This parameter is linked to <i>1-71 Start Delay</i> .
[0]	DC Hld/ Motr Preheat	Energizes motor with a DC holding current (<i>2-00 DC Hold/Preheat Current</i>) during the start delay time.
[2] *	Coast	Releases shaft coasted drive during the start delay time (inverter off). Available selections depend on <i>1-10 Motor Construction</i> : [0] Asynchron: [2] coast [0] DC-hold [1] PM non-salient: [2] coast

1-73 Flying Start		
Option:		Function:
		This function makes it possible to catch a motor that is spinning freely due to a line drop-out. When <i>1-73 Flying Start</i> is enabled, <i>1-71 Start Delay</i> has no function. Search direction for flying start is linked to the setting in <i>4-10 Motor Speed Direction</i> . <i>Clockwise</i> [0]: Flying start search in clockwise direction. If not successful, a DC brake is carried out. <i>Both Directions</i> [2]: The flying start will first make a search in the direction determined by the last reference (direction). If unable to find the speed, it will search in the other direction. If not successful, a DC brake will be activated in the time set in <i>2-02 DC Braking Time</i> . Start will then take place from 0Hz.
[0]	Disabled	Select <i>Disable</i> [0] if this function is not required
[1]	Enabled	Select <i>Enable</i> [1] to enable the Adjustable frequency drive to "catch" and control a spinning motor. The parameter is always set to [1] Enable when <i>1-10 Motor Construction</i> = [1] PM non-salient. Important related parameters:

1-73 Flying Start		
Option:		Function:
		<ul style="list-style-type: none"> • <i>1-58 Flystart Test Pulses Current</i> • <i>1-59 Flystart Test Pulses Frequency</i> • <i>1-70 PM Start Mode</i> • <i>2-06 DC Brake Current</i> • <i>2-07 DC Braking Time</i> • <i>2-03 DC Brake Cut-in Speed [RPM]</i> • <i>2-04 DC Brake Cut-in Speed [Hz]</i> • <i>2-06 DC Brake Current</i> • <i>2-07 DC Braking Time</i>

The Flystart function used for PM motors is based on an initial speed estimation. The speed will always be estimated as the first thing after an active start signal is given. Based on the setting of *1-70 PM Start Mode*, the following will happen:

1-70 PM Start Mode = [0] Rotor Detection:

If the speed estimate comes out as greater than 0 Hz, the adjustable frequency drive will catch the motor at that speed and resume normal operation. Otherwise, the adjustable frequency drive will estimate the rotor position and start normal operation from there.

1-70 PM Start Mode = [1] Parking:

If the speed estimate comes out lower than the setting in *1-59 Flystart Test Pulses Frequency*, then the Parking function will be engaged (see *2-06 DC Brake Current* and *2-07 DC Braking Time*). Otherwise, the adjustable frequency drive will catch the motor at that speed and resume normal operation. Please refer to description of *1-70 PM Start Mode* for recommended settings.

Current limitations of the Flystart Principle used for PM motors:

- The speed range is up to 100% Nominal Speed or the field weakening speed (which ever is lowest).
- PMSM with high back EMF (>300VLL (rms)) and high winding inductance(>10mH) needed more time for reducing short circuit current to zero and may be susceptible to error in estimation.
- Current testing limited to a speed range up to 300Hz. For certain units, the limit is 250Hz; all 200–240V units up to and including 3 HP [2.2 kW] and all 380–480V units up to and including 5.4 HP [4 kW].
- Current testing limited to a machine power size up to 30 HP [22 kW].
- Prepared for salient pole machine (IPMSM) but not yet verified on those types of machine.

- For high inertia applications (i.e., where the load inertia is more than 30 times larger than the motor inertia), a brake resistor is recommended to avoid overvoltage trip during high speed engagement of the fly-start function.

1-77 Compressor Start Max Speed [rpm]

Range:	Function:
0 rpm* [0.0 - max output speed]	<p>The parameter enables "High Starting Torque". This is a function in which the Current Limit and Torque Limit are ignored during start of the motor. The time, from the start signal is given until the speed exceeds the speed set in this parameter, becomes a "start-zone" where the current limit and motoric torque limit is set to what is maximum possible for the adjustable frequency drive/motor combination. This parameter is normally set to the same value as <i>4-11 Motor Speed Low Limit [RPM]</i>. When set to zero the function is inactive.</p> <p>In this "starting-zone" <i>3-82 Starting Ramp-up Time</i> is active instead of <i>3-40 Ramp 1 Type</i> to ensure extra acceleration during the start and to minimize the time where the motor is operated under the minimum speed for the application. The time without protection from the Current Limit and Torque Limit must not exceed the value set in <i>1-79 Compressor Start Max Time to Trip</i> or the Adjustable frequency drive will trip with an alarm [A18] Start Failed. When this function is activated to get a fast start then also <i>1-86 Trip Speed Low [RPM]</i> is activated to protect the application from running below minimum motor speed, e.g., when in current limit.</p> <p>This function allows high starting torque and use of a fast starting ramp. To ensure the build-up of a high torque during the start, various tricks can be done through clever use of start delay / start speed / start current.</p>

NOTE!

1-77 Compressor Start Max Speed [RPM] will not have effect when 1-10 Motor Construction = [1] PM, non-salient SPM.

1-78 Compressor Start Max Speed [Hz]

Range:	Function:
Size related* [0.0 - par. 4-14 Hz]	<p>The parameter enables "High Starting Torque". This is a function in which the Current Limit and Torque Limit are ignored during start of the motor. The time, from the start signal is given until the speed exceeds the speed set in this parameter, becomes a</p>

1-78 Compressor Start Max Speed [Hz]

Range:	Function:
	<p>"start-zone" where the current limit and motor torque limit is set to what is maximum possible for the adjustable frequency drive/motor combination. This parameter is normally set to the same value as <i>4-11 Motor Speed Low Limit [RPM]</i>. When set to zero the function is inactive.</p> <p>In this "starting-zone" <i>3-82 Starting Ramp-up Time</i> is active instead of <i>3-41 Ramp 1 Ramp-up Time</i> to ensure extra acceleration during the start and to minimize the time where the motor is operated under the minimum speed for the application. The time without protection from the Current Limit and Torque Limit must not exceed the value set in <i>1-79 Compressor Start Max Time to Trip</i> or the adjustable frequency drive will trip with an alarm [A18] Start Failed.</p> <p>When this function is activated to get a fast start then also <i>1-86 Trip Speed Low [RPM]</i> is activated to protect the application from running below minimum motor speed, e.g., when in current limit.</p> <p>This function allows high starting torque and use of a fast starting ramp. To ensure the build-up of a high torque during the start, various tricks can be done through clever use of start delay / start speed / start current.</p>

NOTE!

1-78 Compressor Start Max Speed [Hz] will not have effect when 1-10 Motor Construction = [1] PM, non-salient SPM.

1-79 Compressor Start Max Time to Trip

Range:	Function:
5.0 s* [0.0 - 10.0 s]	<p>The time from the start signal is given until the speed exceeds the speed set in <i>1-77 Compressor Start Max Speed [RPM]</i> must not exceed the time set in the parameter or the adjustable frequency drive will trip with an alarm [A18] Start Failed.</p> <p>Any time set in <i>1-71 Start Delay</i> for use of a start function must be executed within the time limit.</p>

NOTE!

1-79 Compressor Start Max Time to Trip will not have effect when 1-10 Motor Construction = [1] PM, non-salient SPM.

3.3.9 1-8* Stop Adjustments

1-80 Function at Stop		
Option:	Function:	
		Select the Adjustable frequency drive function after a stop command or after the speed is ramped down to the settings in <i>1-81 Min Speed for Function at Stop [RPM]</i> . Available selections depend on <i>1-10 Motor Construction</i> : [0] Asynchron: [0] coast [1] DC hold [2] Motor check, warning [6] Motor check, alarm [1] PM non-salient: [0] coast
[0] *	Coast	Leaves motor in free mode.
[1]	DC Hold/ Motor Preheat	Energizes motor with a DC holding current (see <i>2-00 DC Hold/Preheat Current</i>).
[2]	Motor check, warn.	Issues a warning if the motor is not connected.
[6]	Motor check, alarm	Issues an alarm if the motor is not connected.

1-81 Min Speed for Function at Stop [RPM]		
Range:	Function:	
Size related*	[0 - 600 RPM]	

1-82 Min Speed for Function at Stop [Hz]		
Range:	Function:	
Size related*	[0.0 - 20.0 Hz]	

3.3.10 Trip at Motor Speed Low Limit

In *4-11 Motor Speed Low Limit [RPM]* and *4-12 Motor Speed Low Limit [Hz]*, it is possible to set a minimum speed for the motor in order to ensure proper oil distribution. In some cases, e.g., if operating in current limit because of a defect in the compressor, the output motor speed can be suppressed below Motor Speed Low Limit. To prevent damage to the compressor, it is possible to set trip limit. If the motor speed drops below this limit, the Adjustable frequency drive will trip and issue an alarm (A49). Reset will take place according to the selected function in *14-20 Reset Mode*.

If the trip must take place at a fairly precise speed (RPM), it is recommended to set *0-02 Motor Speed Unit* for RPM and use slip compensation, which can be set in *1-62 Slip Compensation*.

NOTE!

To achieve the highest accuracy with the slip compensation, an Automatic Motor Adaptation (AMA) should be performed. To be enabled in *1-29 Automatic Motor Adaptation (AMA)*.

NOTE!

Trip will not be active when using a normal stop or coast command.

1-86 Trip Speed Low [RPM]		
Range:	Function:	
Size related*	[0 - par. 4-13 RPM]	Set the desired motor speed for trip limit. If the trip speed is set to 0, the function is not active. If the speed at any time after the start (or during a stop) falls below the value in the parameter, the adjustable frequency drive will trip with an alarm [A49] Speed Limit. Function at stop.

NOTE!

This parameter is only available if *0-02 Motor Speed Unit* is set to [RPM].

1-87 Trip Speed Low [Hz]		
Range:	Function:	
Size related*	[0.0 - par. 4-14 Hz]	If the trip speed is set to 0, the function is not active. If the speed at any time after the start (or during a stop) falls below the value in the parameter, the adjustable frequency drive will trip with an alarm [A49] Speed Limit. Function at stop.

NOTE!

This parameter is only available if *0-02 Motor Speed Unit* is set to [Hz].

3.3.11 1-9* Motor Temperature

3

1-90 Motor Thermal Protection		
Option:	Function:	
		<p>The Adjustable frequency drive determines the motor temperature for motor protection in two different ways:</p> <ul style="list-style-type: none"> Via a thermistor sensor connected to one of the analog or digital inputs (1-93 Thermistor Source). Via calculation (ETR = Electronic Thermal Relay) of the thermal load, based on the actual load and time. The calculated thermal load is compared with the rated motor current $I_{M,N}$ and the rated motor frequency $f_{M,N}$. The calculations estimate the need for a lower load at lower speed due to less cooling from the fan incorporated in the motor.
[0]	No protection	If the motor is continuously overloaded and no warning or trip of adjustable frequency drive is wanted.
[1]	Thermistor warning	Activates a warning when the connected thermistor in the motor reacts in the event of motor overtemperature.
[2]	Thermistor trip	Stops (trips) the Adjustable frequency drive when the connected thermistor in the motor reacts in the event of motor overtemperature.
[3]	ETR warning 1	
[4] *	ETR trip 1	
[5]	ETR warning 2	
[6]	ETR trip 2	
[7]	ETR warning 3	
[8]	ETR trip 3	
[9]	ETR warning 4	
[10]	ETR trip 4	

ETR (Electronic Thermal Relay) functions 1-4 will calculate the load when the set-up where they were selected is active. For example, ETR-3 starts calculating when set-up 3 is selected. For the North American market: The ETR functions provide class 20 motor overload protection in accordance with NEC.

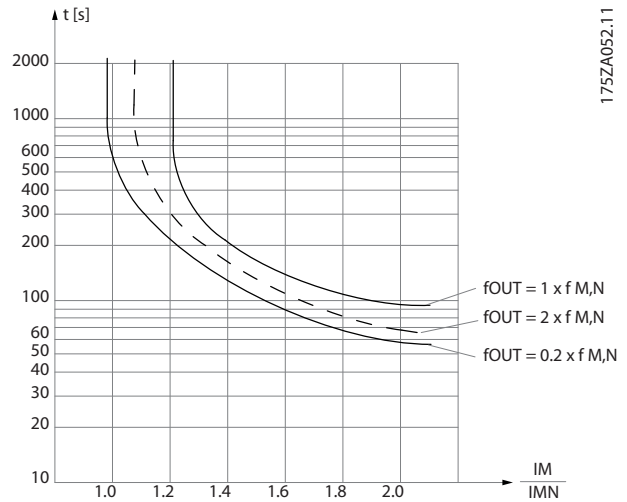

Figure 3.10

WARNING

In order to maintain PELV, all connections made to the control terminals must be PELV, e.g., thermistor must be reinforced/ double-insulated.

NOTE!

Danfoss recommends using 24V DC as thermistor supply voltage.

NOTE!

The ETR timer function does not work when 1-10 Motor Construction = [1] PM, non-salient SPM.

NOTE!

For correct operation of ETR function, setting in 1-03 Torque Characteristics must fit the application (see description of 1-03 Torque Characteristics).

1-91 Motor External Fan		
Option:	Function:	
[0] *	No	No external fan is required, i.e., the motor is derated at low speed.
[1]	Yes	Applies an external motor fan (external ventilation), so that no derating of the motor is required at low speed. The upper curve in graph above ($f_{out} = 1 \times f_{M,N}$) is followed if the motor current is lower than nominal motor current (see 1-24 Motor Current). If the motor current exceeds nominal current, the operation time still decreases as if no fan were installed.

1-93 Thermistor Source		
Option:	Function:	
		Select the input to which the thermistor (PTC sensor) should be connected. An analog input option [1] or [2] cannot be selected if the analog input is already in use as a reference source (selected in 3-15 Reference 1 Source, 3-16 Reference 2 Source or 3-17 Reference 3 Source). When using MCB 112, choice [0] None must always be selected.
[0] *	None	
[1]	Analog input 53	
[2]	Analog input 54	
[3]	Digital input 18	
[4]	Digital input 19	
[5]	Digital input 32	
[6]	Digital input 33	

NOTE!

This parameter cannot be adjusted while the motor is running.

NOTE!

Digital input should be set to [0] PNP - Active at 24 V in 5-00 Digital I/O Mode.

3.4 Main Menu - Brakes - Group 2

3.4.1 2-0* DC Brakes

Parameter group for configuring the DC brake and DC hold functions.

2-00 DC Hold/Preheat Current		
Range:	Function:	
50 %*	[0 - 160. %]	

NOTE!

2-00 DC Hold/Preheat Current will not have effect when 1-10 Motor Construction = [1] PM, non-salient SPM.

NOTE!

The maximum value depends on the rated motor current. Avoid 100% current for too long. It may damage the motor.

2-01 DC Brake Current		
Range:	Function:	
50.0 %*	[0 - 1000. %]	

NOTE!

The maximum value depends on the rated motor current. Avoid 100% current for too long. It may damage the motor.

2-02 DC Braking Time		
Range:	Function:	
10.0 s*	[0.0 - 60.0 s]	Set the duration of the DC braking current set in 2-01 DC Brake Current, once activated.

2-03 DC Brake Cut-in Speed [RPM]		
Range:	Function:	
Size related*	[0 - 0. RPM]	Set the DC brake cut-in speed for activation of the DC braking current set in 2-01 DC Brake Current, upon a stop command. When 1-10 Motor Construction is set to [1] PM non-salient SPM, this value is limited to 0 rpm (OFF)

NOTE!

2-03 DC Brake Cut-in Speed [RPM] will not have effect when 1-10 Motor Construction = [1] PM, non-salient SPM.

2-04 DC Brake Cut-in Speed [Hz]		
Range:	Function:	
Size related*	[0.0 - 0.0 Hz]	This parameter is for setting the DC brake cut-in speed at which the DC braking current (2-01 DC Brake Current) is to be active in connection with a stop command.

NOTE!

will not have effect when 1-10 Motor Construction = [1] PM, non-salient SPM.

2-06 DC Brake Current		
Range:	Function:	
50 %*	[0 - 1000. %]	

2-07 DC Braking Time		
Range:	Function:	
3.0 s*	[0.1 - 60.0 s]	Set the duration of the parking current time set in 2-06 DC Brake Current. Active in connection with 1-73 Flying Start.

3.4.2 2-1* Brake Energy Funct.

Parameter group for selecting dynamic braking parameters. Only valid for adjustable frequency drives with brake chopper.

2-10 Brake Function		
Option:	Function:	
		Available selections depend on <i>1-10 Motor Construction</i> : [0] Asynchron: [0] off [1] Resistor brake [2] AS brake [1] PM non-salient: [0] off [1] Resistor brake
[0] *	Off	No brake resistor installed.
[1]	Resistor brake	Brake resistor incorporated in the system, for dissipation of surplus braking energy as heat. Connecting a brake resistor allows a higher DC link voltage during braking (generating operation). The resistor brake function is only active in adjustable frequency drives with an integral dynamic brake.
[2]	AC brake	AC Brake will only work in Compressor Torque mode in <i>1-03 Torque Characteristics</i> .

2-11 Brake Resistor (ohm)		
Range:	Function:	
Size related* [5.00 - 65535.00 Ohm]	Set the brake resistor value in Ohms. This value is used for monitoring the power to the brake resistor in <i>2-13 Brake Power Monitoring</i> . This parameter is only active in adjustable frequency drives with an integral dynamic brake. Use this parameter for values without decimals. For a selection with two decimals, use <i>30-81 Brake Resistor (ohm)</i> .	

2-12 Brake Power Limit (kW)		
Range:	Function:	
Size related*	[0.001 - 2000.000 kW]	

2-13 Brake Power Monitoring		
Option:	Function:	
	This parameter is only active in adjustable frequency drives with an integral dynamic brake.	

2-13 Brake Power Monitoring		
Option:	Function:	
	This parameter enables monitoring of the power to the brake resistor. The power is calculated on the basis of the resistance (<i>2-11 Brake Resistor (ohm)</i>), the DC link voltage, and the resistor duty time.	
[0] *	Off	No braking energy monitoring is required.
[1]	Warning	Activates a warning on the display when the power transmitted over 120 sec. exceeds 100% of the monitoring limit (<i>2-12 Brake Power Limit (kW)</i>). The warning disappears when the transmitted power falls below 80% of the monitoring limit.
[2]	Trip	Trips the Adjustable frequency drive and displays an alarm when the calculated power exceeds 100% of the monitoring limit.
[3]	Warning and trip	Activates both of the above, including warning, trip and alarm.

If power monitoring is set to *Off* [0] or *Warning* [1], the brake function remains active even if the monitoring limit is exceeded. This may lead to thermal overload of the resistor. It is also possible to generate a warning via a relay/digital output. The measuring accuracy of the power monitoring depends on the accuracy of the resistance of the resistor (better than $\pm 20\%$).

2-15 Brake Check		
Option:	Function:	
	Select type of test and monitoring function to check the connection to the brake resistor, or whether a brake resistor is present, and then display a warning or an alarm in the event of a fault. The brake resistor disconnection function is tested during power-up. However, the brake IGBT test is performed when there is no braking. A warning or trip disconnects the brake function. The testing sequence is as follows:	
	<ol style="list-style-type: none"> 1. The DC link ripple amplitude is measured for 300ms without braking. 2. The DC link ripple amplitude is measured for 300ms with the brake turned on. 3. If the DC link ripple amplitude while braking is lower than the DC link ripple amplitude before braking + 1%. Brake check failed, return a warning or alarm. 4. If the DC link ripple amplitude while braking is higher than the DC link 	

2-15 Brake Check		
Option:	Function:	
		ripple amplitude before braking + 1%. Brake check OK.
[0] *	Off	Monitors brake resistor and brake IGBT for a short-circuit during operation. If a short-circuit occurs, a warning appears.
[1]	Warning	Monitors brake resistor and brake IGBT for a short-circuit, and to run a test for brake resistor disconnection during power-up.
[2]	Trip	Monitors for a short-circuit or disconnection of the brake resistor, or a short-circuit of the brake IGBT. If a fault occurs, the Adjustable frequency drive cuts out while displaying an alarm (trip locked).
[3]	Stop and trip	Monitors for a short-circuit or disconnection of the brake resistor, or a short-circuit of the brake IGBT. If a fault occurs, the Adjustable frequency drive ramps down to coast and then trips. A trip lock alarm is displayed.
[4]	AC brake	

NOTE!

The ramp time is automatically adjusted to avoid tripping of the Adjustable frequency drive.

NOTE!

Remove a warning arising in connection with *Off* [0] or *Warning* [1] by cycling the line power supply. The fault must be corrected first. For *Off* [0] or *Warning* [1], the Adjustable frequency drive keeps running even if a fault is located.

3.4.3 2-16 AC brake Max. Current

2-16 AC brake Max. Current		
Range:	Function:	
100.0 %*	[0.0 - 1000.0 %]	

NOTE!

2-16 AC brake Max. Current will not have effect when *1-10 Motor Construction* = [1] PM, non-salient SPM.

2-17 Over-voltage Control		
Option:	Function:	
[0]	Disabled	No OVC required.
[2] *	Enabled	Activates OVC.

NOTE!

2-17 Over-voltage Control will not have effect when *1-10 Motor Construction* = [1] PM, non-salient SPM.

3.5 Main Menu - Reference/Ramps - Group 3

3.5.1 3-0* Reference Limits

Parameters for setting the reference unit, limits and ranges.

Please see also parameter group 20-0* for information on settings in closed-loop.

3-02 Minimum Reference		
Range:	Function:	
Size related* par. 3-03 ReferenceFeed- backUnit]	Enter the Minimum Reference. The Minimum Reference is the lowest value obtainable by summing all references. The Minimum Reference value and unit matches the configuration choice made in 1-00 Configuration Mode and 20-12 Reference/Feedback Unit, respectively.	
	NOTE! This parameter is used in open-loop only.	

3-04 Reference Function		
Option:	Function:	
[0] * Sum	Sums both external and preset reference sources.	
[1]	External/Preset	Use either the preset or the external reference source. Shift between external and preset via a command on a digital input.

3-04 Reference Function		
Option:	Function:	
[0] * Sum	Sums both external and preset reference sources.	
[1]	External/Preset	Use either the preset or the external reference source. Shift between external and preset via a command on a digital input.

3.5.2 3-1* References

Select the preset reference(s). Select Preset ref. bit 0 / 1 / 2 [16], [17] or [18] for the corresponding digital inputs in parameter group 5-1*.

3-10 Preset Reference		
Array [8]		
Range:	Function:	
0.00 %*	[-100.00 - 100.00 %]	

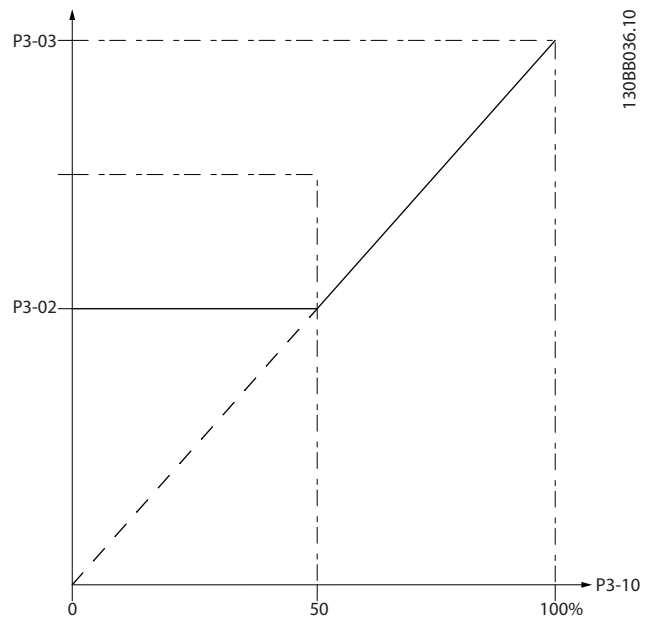

Figure 3.11

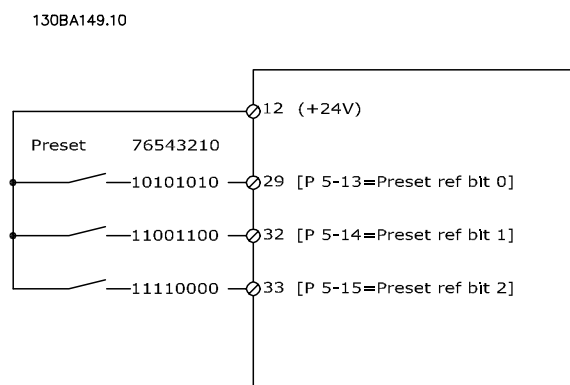

Figure 3.12

3-11 Jog Speed [Hz]		
Range:	Function:	
Size related* [0.0 - par. 4-14 Hz]	The jog speed is a fixed output speed at which the Adjustable frequency drive is running when the jog function is activated. See also 3-80 Jog Ramp Time.	

3-13 Reference Site		
Option:	Function:	
		Select which reference site to activate.
[0] *	Linked to Hand / Auto	Use local reference when in hand mode; or remote reference when in auto mode.
[1]	Remote	Use remote reference in both hand mode and auto mode.
[2]	Local	Use local reference in both hand mode and auto mode. NOTE! When set to Local [2], the Adjustable frequency drive will start with this setting again following a 'power-down'.

3-14 Preset Relative Reference		
Range:	Function:	
0.00 %*	[-100.00 - 100.00 %]	

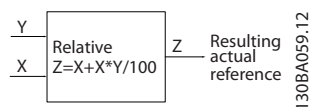

Figure 3.13

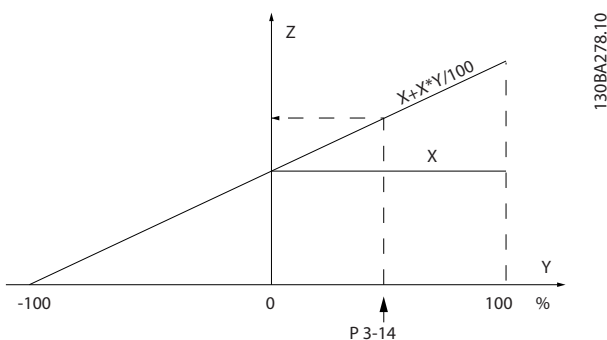

Figure 3.14

3-15 Reference 1 Source		
Option:	Function:	
		Select the reference input to be used for the first reference signal. <i>3-15 Reference 1 Source, 3-16 Reference 2 Source and 3-17 Reference 3 Source</i> define up to three different reference signals. The sum of these reference signals defines the actual reference.
[0]	No function	
[1] *	Analog input 53	
[2]	Analog input 54	

3-15 Reference 1 Source		
Option:	Function:	
[7]	Pulse input 29	
[8]	Pulse input 33	
[20]	Digital pot.meter	
[21]	Analog input X30/11	
[22]	Analog input X30/12	
[23]	Analog Input X42/1	
[24]	Analog Input X42/3	
[25]	Analog Input X42/5	
[29]	Analog Input X48/2	
[30]	Ext. Closed-loop 1	
[31]	Ext. Closed-loop 2	
[32]	Ext. Closed-loop 3	

NOTE!

This parameter cannot be changed while the motor is running.

3-16 Reference 2 Source		
Option:	Function:	
		Select the reference input to be used for the second reference signal. <i>3-15 Reference 1 Source, 3-16 Reference 2 Source and 3-17 Reference 3 Source</i> define up to three different reference signals. The sum of these reference signals defines the actual reference.
[0]	No function	
[1]	Analog input 53	
[2]	Analog input 54	
[7]	Pulse input 29	
[8]	Pulse input 33	
[20] *	Digital pot.meter	
[21]	Analog input X30/11	
[22]	Analog input X30/12	
[23]	Analog Input X42/1	
[24]	Analog Input X42/3	
[25]	Analog Input X42/5	
[29]	Analog Input X48/2	
[30]	Ext. Closed-loop 1	
[31]	Ext. Closed-loop 2	
[32]	Ext. Closed-loop 3	

NOTE!

This parameter cannot be changed while the motor is running.

3-17 Reference 3 Source	
Option:	Function:
	Select the reference input to be used for the third reference signal. 3-15 Reference 1 Source, 3-16 Reference 2 Source and 3-17 Reference 3 Source define up to three different reference signals. The sum of these reference signals defines the actual reference.
[0] *	No function
[1]	Analog input 53
[2]	Analog input 54
[7]	Pulse input 29
[8]	Pulse input 33
[20]	Digital pot.meter
[21]	Analog input X30/11
[22]	Analog input X30/12
[23]	Analog Input X42/1
[24]	Analog Input X42/3
[25]	Analog Input X42/5
[29]	Analog Input X48/2
[30]	Ext. Closed-loop 1
[31]	Ext. Closed-loop 2
[32]	Ext. Closed-loop 3

NOTE!

This parameter cannot be changed while the motor is running.

3-19 Jog Speed [RPM]	
Range:	Function:
Size related* [0 - par. 4-13 RPM]	Enter a value for the jog speed n_{JOG} , which is a fixed output speed. The Adjustable frequency drive runs at this speed when the jog function is activated. The maximum limit is defined in 4-13 Motor Speed High Limit [RPM]. See also 3-80 Jog Ramp Time.

3.5.3 3-4* Ramp 1

Configure the ramp parameter, ramping times, for each of the two ramps (parameter group 3-4* and parameter group 3-5*).

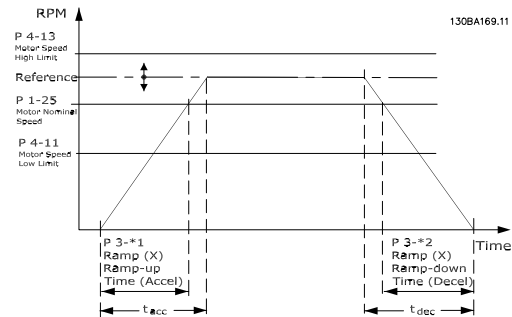

Figure 3.15

3-40 Ramp 1 Type	
Option:	Function:
	Select the ramp type, depending on requirements for acceleration/deceleration. A linear ramp will give constant acceleration during ramping. An S-ramp will give non-linear acceleration, compensating for jerk in the application.
[0] *	Linear
[1]	S-ramp Const Jerk Acceleration with lowest possible jerk.
[2]	S-ramp Const Time S-ramp based on the values set in 3-41 Ramp 1 Ramp up Time and 3-42 Ramp 1 Ramp Down Time.

NOTE!

If S-ramp [1] is selected and the reference during ramping is changed, the ramp time may be prolonged in order to realize a jerk-free movement, which may result in a longer start or stop time.

Additional adjustment of the S-ramp ratios or switching initiators may be necessary.

3-41 Ramp 1 Ramp-up Time	
Range:	Function:
Size related* [1.00 - 3600.00 s]	

$$par.3 - 41 = \frac{t_{acc} \times n_{norm} [par.1 - 25]}{ref[rpm]} [s]$$

3-42 Ramp 1 Ramp-down Time	
Range:	Function:
Size related* [1.00 - 3600.00 s]	

$$par.3 - 42 = \frac{t_{dec} \times n_{norm} [par.1 - 25]}{ref[rpm]} [s]$$

3-45 Ramp 1 S-ramp Ratio at Accel. Start		
Range:	Function:	
50 %* [1 - 99. %]	Enter the proportion of the total ramp-up time (3-41 Ramp 1 Ramp up Time) in which the acceleration torque increases. The larger the percentage value, the greater the jerk compensation achieved, and thus the lower the torque jerks occurring in the application.	

3-46 Ramp 1 S-ramp Ratio at Accel. End		
Range:	Function:	
50 %* [1 - 99. %]	Enter the proportion of the total ramp-up time (3-41 Ramp 1 Ramp up Time) in which the acceleration torque decreases. The larger the percentage value, the greater the jerk compensation achieved, and thus the lower the torque jerks in the application.	

3-47 Ramp 1 S-ramp Ratio at Decel. Start		
Range:	Function:	
50 %* [1 - 99. %]	Enter the proportion of the total ramp-down time (3-42 Ramp 1 Ramp Down Time) where the deceleration torque increases. The larger the percentage value, the greater the jerk compensation achieved, and thus the lower the torque jerks in the application.	

3-48 Ramp 1 S-ramp Ratio at Decel. End		
Range:	Function:	
50 %* [1 - 99. %]	Enter the proportion of the total ramp-down time (3-42 Ramp 1 Ramp Down Time) where the deceleration torque decreases. The larger the percentage value, the greater the jerk compensation achieved, and thus the lower the torque jerks in the application.	

3.5.4 3-5* Ramp 2

Choosing ramp parameters, see parameter group 3-4*.

3-51 Ramp 2 Ramp-up Time		
Range:	Function:	
Size related*	[1.00 - 3600.00 s]	

3-52 Ramp 2 Ramp-down Time		
Range:	Function:	
Size related*	[1.00 - 3600.00 s]	

3-55 Ramp 2 S-ramp Ratio at Accel. Start		
Range:	Function:	
50 %* [1 - 99. %]	Enter the proportion of the total ramp-up time (3-51 Ramp 2 Ramp up Time) in which the acceleration torque increases. The larger the percentage value, the greater the jerk compensation achieved, and thus the lower the torque jerks in the application.	

3-56 Ramp 2 S-ramp Ratio at Accel. End		
Range:	Function:	
50 %* [1 - 99. %]	Enter the proportion of the total ramp-up time (3-51 Ramp 2 Ramp up Time) in which the acceleration torque decreases. The larger the percentage value, the greater the jerk compensation achieved, and thus the lower the torque jerks in the application.	

3-57 Ramp 2 S-ramp Ratio at Decel. Start		
Range:	Function:	
50 %* [1 - 99. %]	Enter the proportion of the total ramp-down time (3-52 Ramp 2 Ramp down Time) where the deceleration torque increases. The larger the percentage value, the greater the jerk compensation achieved, and thus the lower the torque jerks in the application.	

3-58 Ramp 2 S-ramp Ratio at Decel. End		
Range:	Function:	
50 %* [1 - 99. %]	Enter the proportion of the total ramp-down time (3-52 Ramp 2 Ramp down Time) where the deceleration torque decreases. The larger the percentage value, the greater the jerk compensation achieved, and thus the lower the torque jerks in the application.	

3.5.5 3-8* Other Ramps

3-80 Jog Ramp Time		
Range:		Function:
Size related*	[1.00 - 3600.00 s]	Enter the jog ramp time, i.e. the acceleration/deceleration time between 0 RPM and the rated motor speed ($n_{M,N}$) (set in 1-25 Motor Nominal Speed). Ensure that the resultant output current required for the given jog ramp time does not exceed the current limit in 4-18 Current Limit. The jog ramp time starts upon activation of a jog signal via the control panel, a selected digital input, or the serial communication port.
$par. 3 - 80 = \frac{t_{jog} \times n_{norm}[par. 1 - 25]}{jog\ speed [par. 3 - 19]} [s]$		

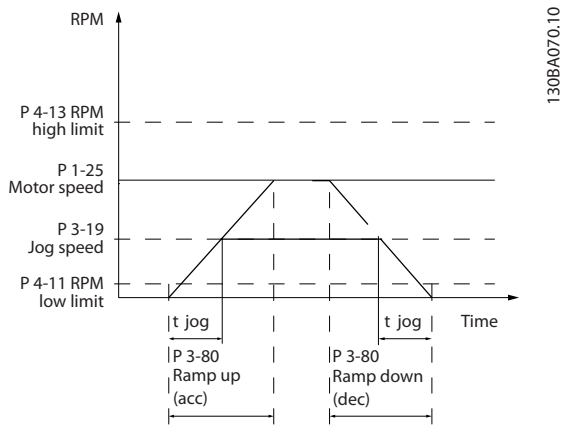

Figure 3.16

3-81 Quick Stop Ramp Time		
Range:		Function:
Size related*	[0.01 - 3600.00 s]	

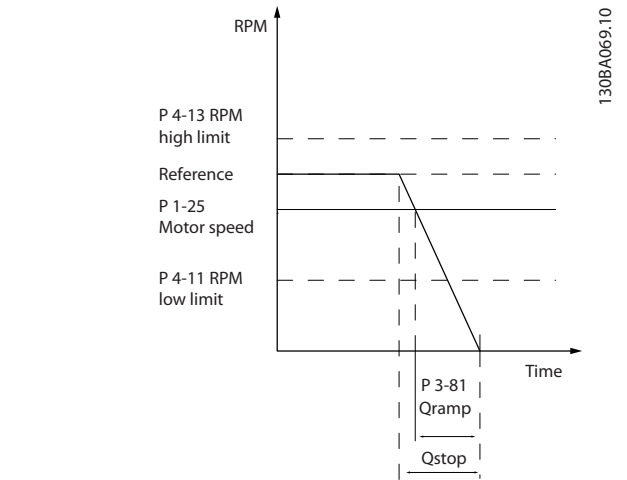

Figure 3.17

$$Par. 3 - 81 = \frac{t_{Qstop} [s] \times n_s [RPM]}{\Delta jog\ ref (par. 3 - 19) [RPM]}$$

3-82 Starting Ramp-up Time		
Range:		Function:
Size related*	[0.01 - 3600.00 s]	The ramp-up time is the acceleration time from 0 rpm to the nominal motor speed set in 3-82 Starting Ramp-up Time when Compressor Torque is active in 1-03 Torque Characteristics.

3.5.6 3-9* Digital Pot.Meter

The digital potentiometer function allows the user to increase or decrease the actual reference by adjusting the set-up of the digital inputs using the functions INCREASE, DECREASE or CLEAR. To activate the function, at least one digital input must be set up to INCREASE or DECREASE.

3-90 Step Size		
Range:		Function:
0.10 %*	[0.01 - 200.00 %]	

3-91 Ramp Time		
Range:	Function:	
1.00 s	[0.00 - 3600.00 s]	Enter the ramp time, i.e., the time for adjustment of the reference from 0% to 100% of the specified digital potentiometer function (INCREASE, DECREASE or CLEAR). If INCREASE/DECREASE is activated for longer than the ramp delay period specified in 3-95 <i>Ramp Delay</i> the actual reference will be ramped up/down according to this ramp time. The ramp time is defined as the time used to adjust the reference by the step size specified in 3-90 <i>Step Size</i> .

3-92 Power Restore		
Option:	Function:	
[0] *	Off	Resets the Digital Potentiometer reference to 0% after power-up.
[1]	On	Restores the most recent Digital Potentiometer reference at power-up.

3-93 Maximum Limit		
Range:	Function:	
100 %*	[-200 - 200 %]	Set the maximum permissible value for the resultant reference. This is advisable if the Digital Potentiometer is used for fine tuning of the resulting reference.

3-94 Minimum Limit		
Range:	Function:	
0 %*	[-200 - 200 %]	

3-95 Ramp Delay		
Range:	Function:	
Size related*	[0.000 - 0.000]	Enter the delay required from activation of the digital potentiometer function until the Adjustable frequency drive starts to ramp the reference. With a delay of 0 ms, the reference starts to ramp as soon as INCREASE/DECREASE is activated. See also 3-91 <i>Ramp Time</i> .

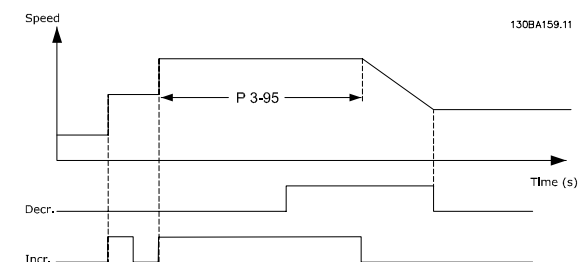

Figure 3.19

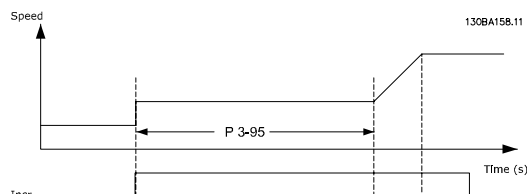

Figure 3.18

3.6 Main Menu - Limits/Warnings - Group 4

3.6.1 4-1* Motor Limits

Define torque, current and speed limits for the motor, and the reaction of the Adjustable frequency drive when the limits are exceeded.

A limit may generate a message on the display. A warning will always generate a message on the display or on the serial communication bus. A monitoring function may initiate a warning or a trip, upon which the Adjustable frequency drive will stop and generate an alarm message.

4-10 Motor Speed Direction		
Option:	Function:	
		Selects the motor speed direction required. Use this parameter to prevent unwanted reversing.
[0]	Clockwise	Only operation in a clockwise direction will be allowed.
[2] *	Both directions	Operation in both a clockwise and counter-clockwise direction will be allowed.

NOTE!

The setting in *4-10 Motor Speed Direction* has impact on the *Flying Start* in *1-73 Flying Start*.

4-11 Motor Speed Low Limit [RPM]		
Range:	Function:	
Size related*	[0 - par. 4-13 RPM]	Enter the minimum limit for motor speed. The Motor Speed Low Limit can be set to correspond to the manufacturer's recommended minimum motor speed. The Motor Speed Low Limit must not exceed the setting in <i>4-13 Motor Speed High Limit [RPM]</i> .

4-12 Motor Speed Low Limit [Hz]		
Range:	Function:	
Size related*	[0 - par. 4-14 Hz]	Enter the minimum limit for motor speed. The Motor Speed Low Limit can be set to correspond to the minimum output frequency of the motor shaft. The Speed Low Limit must not exceed the setting in <i>4-14 Motor Speed High Limit [Hz]</i> .

4-13 Motor Speed High Limit [RPM]		
Range:	Function:	
Size related*	[par. 4-11 - 60000. RPM]	Enter the maximum limit for motor speed. The Motor Speed High Limit can be set to correspond to the manufacturer's maximum rated motor. The Motor Speed High Limit must exceed the setting in <i>4-11 Motor Speed Low Limit [RPM]</i> . Only <i>4-11 Motor Speed Low Limit [RPM]</i> or <i>4-12 Motor Speed Low Limit [Hz]</i> will be displayed, depending on other parameters in the main menu, and depending on default settings dependant on global location.

NOTE!

Max. output frequency cannot exceed 10% of the inverter switching frequency (*14-01 Switching Frequency*).

NOTE!

Any changes in *4-13 Motor Speed High Limit [RPM]* will reset the value in *4-53 Warning Speed High* to the same value as set in *4-13 Motor Speed High Limit [RPM]*.

4-14 Motor Speed High Limit [Hz]		
Range:	Function:	
Size related*	[par. 4-12 - par. 4-19 Hz]	

NOTE!

Max. output frequency cannot exceed 10% of the inverter switching frequency (*14-01 Switching Frequency*).

4-16 Torque Limit Motor Mode		
Range:	Function:	
Size related*	[0.0 - 1000.0 %]	

4-17 Torque Limit Generator Mode		
Range:	Function:	
100.0 %*	[0.0 - 1000.0 %]	

4-18 Current Limit		
Range:	Function:	
Size related*	[1.0 - 1000.0 %]	

4-19 Max Output Frequency		
Range:	Function:	
Size related* [1.0 - 1000.0 Hz]	Enter the maximum output frequency value. <i>4-19 Max Output Frequency</i> specifies the absolute limit on the adjustable frequency drive output frequency for improved safety in applications where accidental overspeeding must be avoided. This absolute limit applies to all configurations and is independent of the setting in <i>1-00 Configuration Mode</i> . This parameter cannot be adjusted while the motor is running. When <i>1-10 Motor Construction</i> is set to [1] PM non-salient SPM the maximum value is limited to 300Hz.	

3.6.2 4-5* Adj. Warnings

Define adjustable warning limits for current, speed, reference and feedback.

NOTE!

Not visible in display, only in VLT Motion Control Tool, MCT 10.

Warnings are shown on display, programmed output or serial bus.

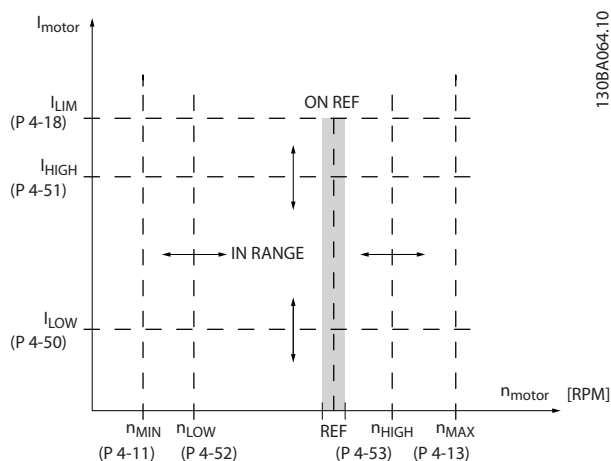

130BA064.10

Figure 3.20

4-50 Warning Current Low		
Range:	Function:	
0.00 A* [0.00 - par. 4-51 A]	Enter the I_{LOW} value. When the motor current falls below this limit (I_{LOW}), the display reads CURRENT LOW. The signal	

4-50 Warning Current Low		
Range:	Function:	
	outputs can be programmed to produce a status signal on terminal 27 or 29 and on relay output 01 or 02. Refer to <i>Figure 3.20</i> .	

4-51 Warning Current High		
Range:	Function:	
Size related* [par. 4-50 - par. 16-37 A]	Enter the I_{HIGH} value. When the motor current exceeds this limit (I_{HIGH}), the display reads CURRENT HIGH. The signal outputs can be programmed to produce a status signal on terminal 27 or 29 and on relay output 01 or 02. Refer to <i>Figure 3.20</i> .	

4-52 Warning Speed Low		
Range:	Function:	
0 RPM* [0 - par. 4-53 RPM]		

4-53 Warning Speed High		
Range:	Function:	
Size related* [par. 4-52 - par. 4-13 RPM]	Enter the n_{HIGH} value. When the motor speed exceeds this limit (n_{HIGH}), the display reads SPEED HIGH. The signal outputs can be programmed to produce a status signal on terminal 27 or 29 and on relay output 01 or 02. Program the upper signal limit of the motor speed, n_{HIGH} , within the normal working range of the Adjustable frequency drive. Refer to <i>Figure 3.20</i> .	

NOTE!

Any changes in *4-13 Motor Speed High Limit [RPM]* will reset the value in *4-53 Warning Speed High* to the same value as set in *4-13 Motor Speed High Limit [RPM]*.

If a different value is needed in *4-53 Warning Speed High*, it must be set after programming of *4-13 Motor Speed High Limit [RPM]*

4-54 Warning Reference Low		
Range:	Function:	
-999999.999 * [-999999.999 - par. 4-55]	Enter the lower reference limit. When the actual reference falls below this limit, the display indicates Ref Low. The signal outputs can be programmed to produce a status signal on terminal 27 or 29 and on relay output 01 or 02.	

4-55 Warning Reference High		
Range:		Function:
999999.999 *	[par. 4-54 - 999999.999]	Enter the upper reference limit. When the actual reference exceeds this limit, the display reads Ref High. The signal outputs can be programmed to produce a status signal on terminal 27 or 29 and on relay output 01 or 02.

4-56 Warning Feedback Low		
Range:		Function:
-999999.999 ProcessCtrlUnit*	[-999999.999 - par. 4-57 ProcessCtrlUnit]	Enter the lower feedback limit. When the feedback falls below this limit, the display reads Feedb Low. The signal outputs can be programmed to produce a status signal on terminal 27 or 29 and on relay output 01 or 02.

4-57 Warning Feedback High		
Range:		Function:
999999.999 ProcessCtrlUnit*	[par. 4-56 - 999999.999 ProcessCtrlUnit]	Enter the upper feedback limit. When the feedback exceeds this limit, the display reads Feedb High. The signal outputs can be programmed to produce a status signal on terminal 27 or 29 and on relay output 01 or 02.

4-58 Missing Motor Phase Function		
Option:	Function:	
	Displays an alarm in the event of a missing motor phase.	
[0]	Disabled	No alarm is displayed if a missing motor phase occurs.
[2] *	Trip 1000 ms	

NOTE!

This parameter cannot be adjusted while the motor is running.

3.6.3 4-6* Speed Bypass

Some systems call for avoiding certain output frequencies or speeds due to resonance problems in the system. A maximum of four frequency or speed ranges can be avoided.

4-60 Bypass Speed From [RPM]		
Array [4]		
Range:		Function:
Size related*	[0 - par. 4-13 RPM]	

4-61 Bypass Speed From [Hz]		
Array [4]		
Range:		Function:
Size related*	[0.0 - par. 4-14 Hz]	Some systems call for avoiding certain output speeds due to resonance problems in the system. Enter the lower limits of the speeds to be avoided.

4-62 Bypass Speed to [RPM]		
Array [4]		
Range:		Function:
Size related*	[0 - par. 4-13 RPM]	

4-63 Bypass Speed To [Hz]		
Array [4]		
Range:		Function:
Size related*	[0.0 - par. 4-14 Hz]	

3.6.4 Semi-Automatic Bypass Speed Set-up

The Semi-Automatic Bypass Speed Set-up can be used to facilitate the programming of the frequencies to be skipped due to resonances in the system.

The following process is to be carried out:

1. Stop the motor.
2. Select Enabled in 4-64 Semi-Auto Bypass Set-up.
3. Press *Hand On* on the LCP to start the search for frequency bands causing resonances. The motor will ramp up according to the ramp set.
4. When sweeping through a resonance band, press *OK* on the LCP when leaving the band. The actual frequency will be stored as the first element in 4-62 *Bypass Speed to [RPM]* or 4-63 *Bypass Speed To [Hz]* (array). Repeat this for each resonance band identified at the ramp-up (maximum four can be adjusted).
5. When maximum speed has been reached, the motor will automatically begin to ramp down. Repeat the above procedure when speed is leaving the resonance bands during the deceleration. The actual frequencies registered when pressing *OK* will be stored in 4-60 *Bypass Speed From [RPM]* or 4-61 *Bypass Speed From [Hz]*.

3

6. When the motor has ramped down to stop, press *OK*. The *4-64 Semi-Auto Bypass Set-up* will automatically reset to *Off*. The Adjustable frequency drive will stay in *Hand* mode until *Off* or *Auto On* are pressed on the LCP.

If the frequencies for a certain resonance band are not registered in the right order (frequency values stored in *By Pass Speed To* are higher than those in *By Pass Speed From*) or if they do not have the same numbers of registrations for the *By Pass From* and *By Pass To*, all registrations will be cancelled and the following message is displayed: *Collected speed areas overlapping or not completely determined. Press [Cancel] to abort.*

4-64 Semi-Auto Bypass Set-up		
Option:	Function:	
[0] *	OFF	No function
[1]	Enabled	Starts the semi-automatic bypass set-up and continue with the procedure described above.

3.7 Main Menu - Digital In/Out - Group 5

3.7.1 5-0* Digital I/O Mode

Parameters for configuring the input and output using NPN and PNP.

5-00 Digital I/O Mode		
Option:	Function:	
		Digital inputs and programmed digital outputs are pre-programmable for operation either in PNP or NPN systems.
[0] *	PNP - Active at 24 V	Action on positive directional pulses (0). PNP systems are pulled down to GND.
[1]	NPN - Active at 0V	Action on negative directional pulses (1). NPN systems are pulled up to +24 V, internally in the Adjustable frequency drive.

NOTE!

This parameter cannot be changed while the motor is running.

5-01 Terminal 27 Mode		
Option:	Function:	
[0] *	Input	Defines terminal 27 as a digital input.
[1]	Output	Defines terminal 27 as a digital output.

NOTE!

This parameter cannot be changed while the motor is running.

5-02 Terminal 29 Mode		
Option:	Function:	
[0] *	Input	Defines terminal 29 as a digital input.
[1]	Output	Defines terminal 29 as a digital output.

NOTE!

This parameter cannot be changed while the motor is running.

3.7.2 5-1* Digital Inputs

Parameters for configuring the input functions for the input terminals.

The digital inputs are used for selecting various functions in the Adjustable frequency drive. All digital inputs can be set to the following functions:

Digital input function	Select	Terminal
No operation	[0]	All *terminal 19, 32, 33

Digital input function	Select	Terminal
Reset	[1]	All
Coast inverse	[2]	27
Coast and reset inverse	[3]	All
DC brake inverse	[5]	All
Stop inverse	[6]	All
External interlock	[7]	All
Start	[8]	All *terminal 18
Latched start	[9]	All
Reversing	[10]	All
Start reversing	[11]	All
Jog	[14]	All *terminal 29
Preset reference on	[15]	All
Preset ref bit 0	[16]	All
Preset ref bit 1	[17]	All
Preset ref bit 2	[18]	All
Freeze reference	[19]	All
Freeze output	[20]	All
Speed up	[21]	All
Slow	[22]	All
Set-up select bit 0	[23]	All
Set-up select bit 1	[24]	All
Pulse input	[32]	terminal 29, 33
Ramp bit 0	[34]	All
Mains failure inverse	[36]	All
Fire mode	[37]	All
Run Permissive	[52]	All
Hand start	[53]	All
Auto start	[54]	All
DigiPot Increase	[55]	All
DigiPot Decrease	[56]	All
DigiPot Clear	[57]	All
Counter A (up)	[60]	29, 33
Counter A (down)	[61]	29, 33
Reset Counter A	[62]	All
Counter B (up)	[63]	29, 33
Counter B (down)	[64]	29, 33
Reset Counter B	[65]	All
Sleep Mode	[66]	All
Reset Maintenance Word	[78]	All
PTC Card 1	[80]	All
Lead Pump Start	[120]	All
Lead Pump Alternation	[121]	All
Pump 1 Interlock	[130]	All
Pump 2 Interlock	[131]	All
Pump 3 Interlock	[132]	All

Table 3.10

3.7.3 5-1* Digital Inputs continued

All = Terminals 18, 19, 27, 29, 32, 33, X30/2, X30/3, X30/4. X30/ are the terminals on MCB 101.

Functions dedicated to only one digital input are stated in the associated parameter.

All digital inputs can be programmed to these functions

[0]	No operation	No reaction to signals transmitted to terminal.
[1]	Reset	Resets Adjustable frequency drive after a TRIP/ALARM. Not all alarms can be reset.
[2]	Coast inverse	Leaves motor in free mode. Logic '0' => coasting stop. (Default Digital input 27): Coasting stop, inverted input (NC).
[3]	Coast and reset inverse	Reset and coasting stop Inverted input (NC). Leaves motor in free mode and resets the Adjustable frequency drive. Logic '0' => coasting stop and reset.
[5]	DC brake inverse	Inverted input for DC braking (NC). Stops motor by energizing it with a DC current for a certain time period. See 2-01 DC Brake Current to 2-03 DC Brake Cut-in Speed [RPM]. The function is only active when the value in 2-02 DC Braking Time is different from 0. Logic '0' => DC braking. This selection is not possible when 1-10 Motor Construction is set to [1] PM non-salient SPM.
[6]	Stop inverse	Stop Inverted function. Generates a stop function when the selected terminal goes from logical level '1' to '0'. The stop is performed according to the selected ramp time (3-42 Ramp 1 Ramp-down Time, 3-52 Ramp 2 Ramp-down Time, 3-62 Ramp 3 Ramp down Time, 3-72 Ramp 4 Ramp Down Time). NOTE! When the Adjustable frequency drive is at the torque limit and has received a stop command, it may not stop by itself. To ensure that the Adjustable frequency drive stops, configure a digital output to <i>Torque limit & stop</i> [27] and connect this digital output to a digital input that is configured as coast.
[7]	External Interlock	Same function as Coasting stop, inverse, but External Interlock generates the alarm

		message 'external fault' on the display when the terminal which is programmed for Coast Inverse is logic '0'. The alarm message will also be active via digital outputs and relay outputs, if programmed for External Interlock. The alarm can be reset using a digital input or the [RESET] key if the cause for the External Interlock has been removed. A delay can be programmed in 22-00 External Interlock Delay, External Interlock Time. After applying a signal to the input, the reaction described above will be delayed with the time set in 22-00 External Interlock Delay.
[8]	Start	Select start for a start/stop command. Logic '1' = start, logic '0' = stop. (Default Digital input 18)
[9]	Latched start	Motor starts, if a pulse is applied for min. 2 ms. Motor stops when Stop inverse is activated
[10]	Reversing	Changes direction of motor shaft rotation. Select Logic '1' to reverse. The reversing signal only changes the direction of rotation. It does not activate the start function. Select both directions in 4-10 Motor Speed Direction. (Default Digital input 19).
[11]	Start reversing	Used for start/stop and for reversing on the same wire. Signals on start are not allowed at the same time.
[14]	Jog	Used for activating jog speed. See 3-11 Jog Speed [Hz]. (Default Digital input 29)
[15]	Preset reference on	Used for shifting between external reference and preset reference. It is assumed that External/preset [1] has been selected in 3-04 Reference Function. Logic '0' = external reference active; logic '1' = one of the eight preset references is active.
[16]	Preset ref bit 0	Enables a choice between one of the eight preset references according to the table below.
[17]	Preset ref bit 1	Enables a choice between one of the eight preset references according to the table below.
[18]	Preset ref bit 2	Enables a choice between one of the eight preset references according to the table below.

Preset ref. bit	2	1	0
Preset ref. 0	0	0	0
Preset ref. 1	0	0	1
Preset ref. 2	0	1	0
Preset ref. 3	0	1	1
Preset ref. 4	1	0	0
Preset ref. 5	1	0	1
Preset ref. 6	1	1	0
Preset ref. 7	1	1	1

Table 3.11

[19]	Freeze ref	Freezes actual reference. The frozen reference is now the point of enable/condition for Speed up and Slow to be used. If Speed up/Slow is used, the speed change always follows ramp 2 (3-51 Ramp 2 Ramp-up Time and 3-52 Ramp 2 Ramp-down Time) in the range 0 - 3-03 Maximum Reference. (For closed-loop, see 20-14 Maximum Reference/Feedb.).
[20]	Freeze output	Freezes actual motor frequency (Hz). The frozen motor frequency is now the point of enable/condition for Speed up and Slow to be used. If Speed up/Slow is used, the speed change always follows ramp 2 (3-51 Ramp 2 Ramp-up Time and 3-52 Ramp 2 Ramp-down Time) in the range 0 - 1-23 Motor Frequency. NOTE! When Freeze output is active, the Adjustable frequency drive cannot be stopped via a low 'start [13]' signal. Stop the Adjustable frequency drive via a terminal programmed for Coasting inverse [2] or Coast and reset, inverse [3].
[21]	Speed up	For digital control of the up/down speed is desired (motor potentiometer). Activate this function by selecting either Freeze reference or Freeze output. When Speed up is activated for less than 400 msec. the resulting reference will be increased by 0.1 %. If Speed up is activated for more than 400 msec., the resulting reference will ramp according to Ramp 1 in 3-41 Ramp 1 Ramp-up Time.
[22]	Slow	Same as Speed up [21].
[23]	Set-up select bit 0	Selects one of the four set-ups. Set par. 0-10 to Multi Set-up.
[24]	Set-up select bit 1	Same as Set-up select bit 0 [23]. (Default Digital input 32)

[32]	Pulse input	Select Pulse input when using a pulse sequence as either reference or feedback. Scaling is done in parameter group 5-5*.
[34]	Ramp bit 0	Select which ramp to use. Logic "0" will select ramp 1 while logic "1" will select ramp 2.
[36]	Mains failure inverse	Select to activate function selected in 14-10 Mains Failure. Line failure is active in the Logic "0" situation.
[37]	Fire mode	A signal applied will put the Adjustable frequency drive into Fire Mode and all other commands will be disregarded. See 24-0* Fire Mode.
[52]	Run Permissive	The input terminal, for which the Run permissive has been programmed must be logic "1" before a start command can be accepted. Run permissive has a logic 'AND' function related to the terminal which is programmed for START [8], Jog [14] or Freeze Output [20], which means that in order to start running the motor, both conditions must be fulfilled. If Run Permissive is programmed on multiple terminals, Run permissive needs only be logic '1' on one of the terminals for the function to be carried out. The digital output signal for Run Request (Start [8], Jog [14] or Freeze output [20]) programmed in parameter group 5-3*, or parameter group 5-4*, will not be affected by Run Permissive. NOTE! If no Run Permissive signal is applied but either Run, Jog or Freeze commands is activated, the status line in the display will show either Run Requested, Jog Requested or Freeze Requested.
[53]	Hand start	A signal applied will put the Adjustable frequency drive into Hand mode as if button <i>Hand On</i> on the LCP has been pressed and a normal stop command will be overridden. If disconnecting the signal, the motor will stop. To make any other start commands valid, another digital input must be assigned to <i>Auto-Start</i> and a signal applied to this. The <i>Hand On</i> and <i>Auto On</i> buttons on the LCP has no impact. The <i>Off</i> button on the LCP will override <i>Hand Start</i> and <i>Auto-Start</i> . Press either the <i>Hand On</i> or <i>Auto On</i> button to make <i>Hand Start</i> and <i>Auto-Start</i> active again. If no signal on either <i>Hand Start</i> or <i>Auto-Start</i> , the motor will stop regardless of any normal Start command applied. If signal applied to both

		<i>Hand Start</i> and <i>Auto-Start</i> , the function will be <i>Auto-Start</i> . If pressing the <i>Off</i> button on the LCP, the motor will stop regardless of signals on <i>Hand Start</i> and <i>Auto-Start</i> .
[54]	Auto start	A signal applied will put the Adjustable frequency drive into auto mode as if the LCP button <i>Auto On</i> has been pressed. See also <i>Hand Start</i> [53]
[55]	DigiPot Increase	Uses the input as an INCREASE signal to the Digital Potentiometer function described in parameter group 3-9*
[56]	DigiPot Decrease	Uses the input as a DECREASE signal to the Digital Potentiometer function described in parameter group 3-9*
[57]	DigiPot Clear	Uses the input to CLEAR the Digital Potentiometer reference described in parameter group 3-9*
[60]	Counter A (up)	(Terminal 29 or 33 only) Input for increment counting in the SLC counter.
[61]	Counter A (down)	(Terminal 29 or 33 only) Input for decrement counting in the SLC counter.
[62]	Reset Counter A	Input for reset of counter A.
[63]	Counter B (up)	(Terminal 29 and 33 only) Input for increment counting in the SLC counter.
[64]	Counter B (down)	(Terminal 29 and 33 only) Input for decrement counting in the SLC counter.
[65]	Reset Counter B	Input for reset of counter B.
[66]	Sleep Mode	Forces Adjustable frequency drive into Sleep Mode (see parameter group 22-4*). Reacts on the rising edge of signal applied!
[68]	Timed Actions Disabled	Timed actions are disabled. See parameter group 23-0* <i>Timed Actions</i> .
[69]	Constant OFF	<i>Timed Actions</i> are set for Constant OFF. See parameter group 23-0* <i>Timed Actions</i> .
[70]	Constant ON	<i>Timed Actions</i> are set for Constant ON. See parameter group 23-0* <i>Timed Actions</i> .
[78]	Reset Preventive Maintenance Word	Resets all data in 16-96 <i>Maintenance Word</i> to 0.
[80]	PTC Card 1	All digital inputs can be set to PTC card 1 [80]. However, only one digital input must be set to this choice.

5-10 Terminal 18 Digital Input

Same options and functions as parameter group 5-1*, except for *Pulse input*.

Option:	Function:
[8] *	Start

5-11 Terminal 19 Digital Input

Same options and functions as parameter group 5-1*, except for *Pulse input*.

Option:	Function:
[0] *	No operation

5-12 Terminal 27 Digital Input

Option:	Function:
[2] *	Coast inverse Functions are described under parameter group 5-1* <i>Digital Inputs</i>

3.7.4 5-13 Terminal 29 Digital Input

5-13 Terminal 29 Digital Input

Option:	Function:
[14] *	Jog Functions are described under 5-1* <i>Digital Inputs</i>

5-14 Terminal 32 Digital Input

Option:	Function:
[0] *	No Operation Same options and functions as parameter group 5-1* <i>Digital Inputs</i> , except for <i>Pulse input</i> .

5-15 Terminal 33 Digital Input

Option:	Function:
[0] *	No Operation Same options and functions as parameter group 5-1* <i>Digital Inputs</i> .

5-16 Terminal X30/2 Digital Input

This parameter is active when option module MCB 101 is installed in the Adjustable frequency drive. Same options and functions as parameter group 5-1* except for *Pulse input* [32].

Option:	Function:
[0] *	No operation

5-17 Terminal X30/3 Digital Input

This parameter is active when option module MCB 101 is installed in the Adjustable frequency drive. Same options and functions as parameter group 5-1* except for *Pulse input* [32].

Option:	Function:
[0] *	No operation

5-18 Terminal X30/4 Digital Input

This parameter is active when option module MCB 101 is installed in the Adjustable frequency drive. Same options and functions as parameter group 5-1* except for *Pulse input* [32].

Option:	Function:
[0] *	No operation

5-19 Terminal 37 Safe Stop		
Option:	Function:	
[1] *	Safe Stop Alarm	Coasts Adjustable frequency drive when safe stop is activated. Manual reset from LCP, digital input or serial communication bus.
[3]	Safe Stop Warning	Coasts Adjustable frequency drive when safe stop is activated (T-37 off). When safe stop circuit is reestablished, the Adjustable frequency drive will continue without manual reset.
[4]	PTC 1 Alarm	Coasts Adjustable frequency drive when safe stop is activated. Manual reset from LCP, digital input or serial communication bus. Choice 4 is only available when the MCB 112 PTC thermistor card is connected.
[5]	PTC 1 Warning	Coasts Adjustable frequency drive when safe stop is activated (T-37 off). When safe stop circuit is reestablished, the Adjustable frequency drive will continue without manual reset, unless a Digital Input set to PTC Card 1 [80] is still enabled. Choice 5 is only available when the MCB 112 PTC thermistor card is connected.
[6]	PTC 1 & Relay A	This choice is used when the PTC option is gated together with a stop button through a safety relay to T-37. Coasts Adjustable frequency drive when safe stop is activated. Manual reset from LCP, digital input or serial communication bus. Choice 6 is only available when the MCB 112 PTC thermistor card is connected.
[7]	PTC 1 & Relay W	This choice is used when the PTC option is gated together with a stop button through a safety relay to T-37. Coasts Adjustable frequency drive when safe stop is activated (T-37 off). When safe stop circuit is reestablished, the Adjustable frequency drive will continue without manual reset, unless a Digital Input set to PTC Card 1 [80] is (still) enabled. Choice 7 is only available when the MCB 112 PTC thermistor card is connected.
[8]	PTC 1 & Relay A/W	This choice makes it possible to use a combination of alarm and warning. Choice 8 is only available when the MCB 112 PTC thermistor card is connected.
[9]	PTC 1 & Relay W/A	This choice makes it possible to use a combination of alarm and warning. Choice 9 is only available when the MCB 112 PTC thermistor card is connected.

Choices 4–9 are only available when the MCB 112 PTC thermistor card is connected.

NOTE!

When Auto Reset/Warning is selected the Adjustable frequency drive opens up for automatic restart.

Overview of functions, alarms and warnings

Function	No.	PTC	Relay
No Function	[0]	-	-
Safe Stop Alarm	[1]*	-	Safe Stop [A68]
Safe Stop Warning	[3]	-	Safe Stop [W68]
PTC 1 Alarm	[4]	PTC 1 Safe Stop [A71]	-
PTC 1 Warning	[5]	PTC 1 Safe Stop [W71]	-
PTC 1 & Relay A	[6]	PTC 1 Safe Stop [A71]	Safe Stop [A68]
PTC 1 & Relay W	[7]	PTC 1 Safe Stop [W71]	Safe Stop [W68]
PTC 1 & Relay A/W	[8]	PTC 1 Safe Stop [A71]	Safe Stop [W68]
PTC 1 & Relay W/A	[9]	PTC 1 Safe Stop [W71]	Safe Stop [A68]

Table 3.12

W means warning, and A means alarm. For further information, see Alarms and Warnings in section Troubleshooting in the Design Guide or in the Instruction Manual.

A dangerous failure related to the safe stop will give alarm: Dangerous Failure [A72].

Please refer to *Table 4.3* in *4.1 Troubleshooting*.

3.7.5 5-3* Digital Outputs

Parameters for configuring the output functions for the output terminals. The 2 solid-state digital outputs are common for terminals 27 and 29. Set the I/O function for terminal 27 in *5-01 Terminal 27 Mode* and set the I/O function for terminal 29 in *5-02 Terminal 29 Mode*. These parameters cannot be adjusted while the motor is running.

		The digital outputs can be programmed with these functions:
[0]	No operation	<i>Default for all digital outputs and relay outputs</i>
[1]	Control ready	The control board receives supply voltage.
[2]	Drive ready	The Adjustable frequency drive is ready for operation and applies a supply signal on the control board.

[3]	Drive ready / remote control	The Adjustable frequency drive is ready for operation and is in Auto On mode.
[4]	Stand-by / no warning	The Adjustable frequency drive is ready for operation. No start or stop command is been given (start/disable). There are no warnings.
[5]	Running	The motor is running.
[6]	Running / no warning	The output speed is higher than the speed set in <i>1-81 Min Speed for Function at Stop [RPM]</i> . The motor is running and there are no warnings.
[8]	Run on reference / no warning	The motor runs at reference speed.
[9]	Alarm	An alarm activates the output. There are no warnings.
[10]	Alarm or warning	An alarm or a warning activates the output.
[11]	At torque limit	The torque limit set in <i>4-16 Torque Limit Motor Mode</i> or <i>4-13 Motor Speed High Limit [RPM]</i> has been exceeded.
[12]	Out of current range	The motor current is outside the range set in <i>4-18 Current Limit</i> .
[13]	Below current, low	The motor current is lower than set in <i>4-50 Warning Current Low</i> .
[14]	Above current, high	The motor current is higher than set in <i>4-51 Warning Current High</i> .
[15]	Out of speed range	The output speed is outside the range set in <i>4-52 Warning Speed Low</i> and <i>4-53 Warning Speed High</i> .
[16]	Below speed, low	The output speed is lower than the setting in <i>4-52 Warning Speed Low</i> .
[17]	Above speed, high	The output speed is higher than the setting in <i>4-53 Warning Speed High</i> .
[18]	Out of feedback range	The feedback is outside the range set in <i>4-56 Warning Feedback Low</i> and <i>4-57 Warning Feedback High</i> .
[19]	Below feedback low	The feedback is below the limit set in <i>4-56 Warning Feedback Low</i> .
[20]	Above feedback high	The feedback is above the limit set in <i>4-57 Warning Feedback High</i> .
[21]	Thermal warning	The thermal warning turns on when the temperature exceeds the limit in the motor, the Adjustable frequency drive, the brake resistor, or the thermistor.
[25]	Reverse	<i>Reversing. Logic '1' = relay activated, 24V DC when CW rotation of the motor. Logic '0' = relay not activated, no signal, when CCW rotation of the motor.</i>
[26]	Bus OK	Active communication (no timeout) via the serial communication port.
[27]	Torque limit and stop	Use in performing a coasting stop and in torque limit condition. If the Adjustable

		frequency drive has received a stop signal and is at the torque limit, the signal is Logic '0'.
[28]	Brake, no warning	The brake is active and there are no warnings.
[29]	Brake ready, no fault	The brake is ready for operation and there are no faults.
[30]	Brake fault (IGBT)	The output is Logic '1' when the brake IGBT is short-circuited. Use this function to protect the Adjustable frequency drive if there is a fault on the brake modules. Use the output/relay to cut out the AC line voltage from the Adjustable frequency drive.
[35]	External Interlock	External Interlock function has been activated via one of the digital inputs.
[40]	Out of ref range	
[41]	Below reference low	
[42]	Above reference high	
[45]	Bus Ctrl	
[46]	Bus Ctrl 1 if timeout	
[47]	Bus Ctrl 0 if timeout	
[55]	Pulse output	
[60]	Comparator 0	See parameter group 13-1*. If Comparator 0 is evaluated as TRUE, the output will go high. Otherwise, it will be low.
[61]	Comparator 1	See parameter group 13-1*. If Comparator 2 is evaluated as TRUE, the output will go high. Otherwise, it will be low.
[62]	Comparator 2	See parameter group 13-1*. If Comparator 2 is evaluated as TRUE, the output will go high. Otherwise, it will be low.
[63]	Comparator 3	See parameter group 13-1*. If Comparator 3 is evaluated as TRUE, the output will go high. Otherwise, it will be low.
[64]	Comparator 4	See parameter group 13-1*. If Comparator 4 is evaluated as TRUE, the output will go high. Otherwise, it will be low.
[65]	Comparator 5	See parameter group 13-1*. If Comparator 5 is evaluated as TRUE, the output will go high. Otherwise, it will be low.
[70]	Logic Rule 0	See parameter group 13-4*. If Logic Rule 0 is evaluated as TRUE, the output will go high. Otherwise, it will be low.
[71]	Logic Rule 1	See parameter group 13-4*. If Logic Rule 1 is evaluated as TRUE, the output will go high. Otherwise, it will be low.

Parameter Description

VLT[®] HVAC Drive Programming Guide

[72]	Logic Rule 2	See parameter group 13-4*. If Logic Rule 2 is evaluated as TRUE, the output will go high. Otherwise, it will be low.
[73]	Logic Rule 3	See parameter group 13-4*. If Logic Rule 3 is evaluated as TRUE, the output will go high. Otherwise, it will be low.
[74]	Logic Rule 4	See parameter group 13-4*. If Logic Rule 4 is evaluated as TRUE, the output will go high. Otherwise, it will be low.
[75]	Logic Rule 5	See parameter group 13-4*. If Logic Rule 5 is evaluated as TRUE, the output will go high. Otherwise, it will be low.
[80]	SL Digital Output A	See 13-52 <i>SL Controller Action</i> . The input will go high whenever the Smart Logic Action [38] <i>Set dig. out. A high</i> is executed. The input will go low whenever the Smart Logic Action [32] <i>Set dig. out. A low</i> is executed.
[81]	SL Digital Output B	See 13-52 <i>SL Controller Action</i> . The input will go high whenever the Smart Logic Action [39] <i>Set dig. out. B high</i> is executed. The input will go low whenever the Smart Logic Action [33] <i>Set dig. out. B low</i> is executed.
[82]	SL Digital Output C	See 13-52 <i>SL Controller Action</i> . The input will go high whenever the Smart Logic Action [40] <i>Set dig. out. C high</i> is executed. The input will go low whenever the Smart Logic Action [34] <i>Set dig. out. C low</i> is executed.
[83]	SL Digital Output D	See 13-52 <i>SL Controller Action</i> . The input will go high whenever the Smart Logic Action [41] <i>Set dig. out. D high</i> is executed. The input will go low whenever the Smart Logic Action [35] <i>Set dig. out. D low</i> is executed.
[84]	SL Digital Output E	See 13-52 <i>SL Controller Action</i> . The input will go high whenever the Smart Logic Action [42] <i>Set dig. out. E high</i> is executed. The input will go low whenever the Smart Logic Action [36] <i>Set dig. out. E low</i> is executed.
[85]	SL Digital Output F	See 13-52 <i>SL Controller Action</i> . The input will go high whenever the Smart Logic Action [43] <i>Set dig. out. F high</i> is executed. The input will go low whenever the Smart Logic Action [37] <i>Set dig. out. F low</i> is executed.
[160]	No alarm	The output is high when no alarm is present.
[161]	Running reverse	The output is high when the Adjustable frequency drive is running counter clockwise (the logical product of the status bits 'running' AND 'reverse').

[165]	Local reference active	The output is high when 3-13 <i>Reference Site</i> = [2] <i>Local</i> or when 3-13 <i>Reference Site</i> = [0] <i>Linked to hand auto</i> at the same time as the LCP is in [Hand On] mode.
[166]	Remote reference active	The output is high when 3-13 <i>Reference Site</i> [1] or <i>Linked to hand/auto</i> [0] while the LCP is in [Auto on] mode.
[167]	Start command active	The output is high when there is an active Start command (i.e., via digital input bus connection or [Hand on] or [Auto on]), and no Stop command is active.
[168]	Drive in hand mode	The output is high when the Adjustable frequency drive is in Hand on mode (as indicated by the LED light above [Hand on]).
[169]	Drive in auto mode	The output is high when the Adjustable frequency drive is in Hand on mode (as indicated by the LED light above [Auto on]).
[180]	Clock Fault	The clock function has been reset to default (2000-01-01) because of a power failure.
[181]	Preventive Maintenance	One or more of the preventive maintenance events programmed in 23-10 <i>Maintenance Item</i> has passed the time for the specified action in 23-11 <i>Maintenance Action</i> .
[190]	No-Flow	A No-Flow situation or Minimum Speed situation has been detected if enabled in 22-21 <i>Low Power Detection</i> and/or 22-22 <i>Low Speed Detection</i> .
[191]	Dry Pump	A dry pump condition has been detected. This function must be enabled in 22-26 <i>Dry Pump Function</i> .
[192]	End of Curve	A pump running with max. speed for a period of time without reaching the set pressure has been detected. To enable this function, see 22-50 <i>End of Curve Function</i> .
[193]	Sleep Mode	The Adjustable frequency drive/system has turned into sleep mode. See par. 22-4*.
[194]	Broken Belt	A Broken Belt condition has been detected. This function must be enabled in 22-60 <i>Broken Belt Function</i> .
[195]	Bypass Valve Control	The bypass valve control (Digital / Relay output in the Adjustable frequency drive) is used for compressor systems to unload the compressor during start-up by using a bypass valve. After the start command is given the bypass valve will be open until the Adjustable frequency drive reaches 4-11 <i>Motor Speed Low Limit [RPM]</i> . After the limit has been reached the bypass

valve will be closed, allowing the compressor to operate normally. This procedure will not be activated again before a new start is initiated and the Adjustable frequency drive speed is zero during the receiving of start signal. 1-71 *Start Delay* can be used in order to delay the motor start. The Bypass valve control principle:

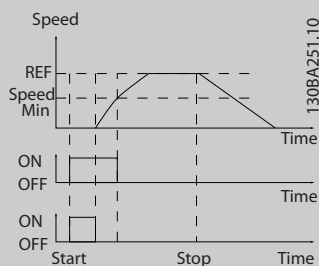

Figure 3.21

[196]	Fire Mode	The Adjustable frequency drive is operating in Fire Mode. See parameter group 24-0* <i>Fire Mode</i> .
[197]	Fire Mode was Act.	The Adjustable frequency drive has been operating in Fire Mode, but is now back in normal operation.
[198]	Drive Bypass	To be used as signal for activating an external electromechanical bypass switching the motor direct on line. See 24-1* <i>Drive Bypass</i> . CAUTION If enabling the Drive Bypass Function, the Adjustable frequency drive is no longer Safety Certified (for using the Safe Stop in versions where included).

The setting options below are all related to the cascade controller.

Wiring diagrams and settings for parameter, see parameter group 25-** for more details.

[200]	Full Capacity	All pumps running and at full speed
[201]	Pump1 Running	One or more of the pumps controlled by the cascade controller are running. The function will also depend on the setting of in 25-06 <i>Number Of Pumps</i> . If set to <i>No</i> [0] Pump 1 refers to the pump controlled by relay RELAY1 etc. If set to <i>Yes</i> [1] Pump 1 refers to the pump controlled by the Adjustable frequency drive only (without any of the build in relays involved) and Pump 2 to the pump

		controlled by the relay RELAY1. See the table below:
[202]	Pump2 Running	See [201]
[203]	Pump3 Running	See [201]

Setting in parameter group 5-3*	Setting in 25-06 Number Of Pumps	
	[0] No	[1] Yes
[200] Pump 1 Running	Controlled by RELAY1	Adjustable Frequency Drive controlled
[201] Pump 2 Running	Controlled by RELAY2	Controlled by RELAY1
[203] Pump 3 Running	Controlled by RELAY3	Controlled by RELAY2

Table 3.13

5-30 Terminal 27 Digital Output

Same options and functions as parameter group 5-3*.

Option: Function:

[0] *	No operation	
-------	--------------	--

5-31 Terminal 29 Digital Output

Same options and functions as parameter group 5-3*.

Option: Function:

[0] *	No operation	
-------	--------------	--

5-32 Term X30/6 Digi Out (MCB 101)

This parameter is active when option module MCB 101 is mounted in the Adjustable frequency drive. Same options and functions as parameter group 5-3*.

Option: Function:

[0] *	No operation	
-------	--------------	--

5-33 Term X30/7 Digi Out (MCB 101)

This parameter is active when option module MCB 101 is mounted in the Adjustable frequency drive. Same options and functions as parameter group 5-3*.

Option: Function:

[0] *	No operation	
-------	--------------	--

3.7.6 5-4* Relays

Parameters for configuring the timing and the output functions for the relays.

5-40 Function Relay		
Array [8] (Relay 1 [0], Relay 2 [1]) Option MCB 105: Relay 7 [6], Relay 8 [7] and Relay 9 [8]). Select options to define the function of the relays. The selection of each mechanical relay is realized in an array parameter.		
Option:	Function:	
[0] *	No operation	
[1]	Control ready	
[2]	Drive ready	
[3]	Drive rdy/rem ctrl	
[4]	Standby / no warning	
[5] *	Running	Default setting for relay 2.
[6]	Running / no warning	
[8]	Run on ref/no warn	
[9] *	Alarm	Default setting for relay 1.
[10]	Alarm or warning	
[11]	At torque limit	
[12]	Out of current range	
[13]	Below current, low	
[14]	Above current, high	
[15]	Out of speed range	
[16]	Below speed, low	
[17]	Above speed, high	
[18]	Out of feedb. range	
[19]	Below feedback, low	
[20]	Above feedback, high	
[21]	Thermal warning	
[25]	Reverse	
[26]	Bus OK	
[27]	Torque limit stop	
[28]	Brake: No Brake War	
[29]	Brake ready, no fault	
[30]	Brake fault (IGBT)	
[35]	External Interlock	
[36]	Control word bit 11	
[37]	Control word bit 12	
[40]	Out of ref range	
[41]	Below reference, low	
[42]	Above ref, high	
[45]	Bus ctrl.	
[46]	Bus ctrl, 1 if timeout	
[47]	Bus ctrl, 0 if timeout	
[60]	Comparator 0	

5-40 Function Relay		
Array [8] (Relay 1 [0], Relay 2 [1]) Option MCB 105: Relay 7 [6], Relay 8 [7] and Relay 9 [8]). Select options to define the function of the relays. The selection of each mechanical relay is realized in an array parameter.		
Option:	Function:	
[61]	Comparator 1	
[62]	Comparator 2	
[63]	Comparator 3	
[64]	Comparator 4	
[65]	Comparator 5	
[70]	Logic rule 0	
[71]	Logic rule 1	
[72]	Logic rule 2	
[73]	Logic rule 3	
[74]	Logic rule 4	
[75]	Logic rule 5	
[80]	SL digital output A	
[81]	SL digital output B	
[82]	SL digital output C	
[83]	SL digital output D	
[84]	SL digital output E	
[85]	SL digital output F	
[160]	No alarm	
[161]	Running reverse	
[165]	Local ref active	
[166]	Remote ref active	
[167]	Start command act.	
[168]	Hand/Off	
[169]	Auto mode	
[180]	Clock Fault	
[181]	Prev. Maintenance	
[188]	AHF Capacitor Connect	
[189]	External Fan Control	
[190]	No-Flow	
[191]	Dry Pump	
[192]	End Of Curve	
[193]	Sleep Mode	
[194]	Broken Belt	
[195]	Bypass Valve Control	
[196]	Fire Mode	
[197]	Fire Mode was Act.	
[198]	Drive Bypass	
[211]	Cascade Pump 1	
[212]	Cascade Pump 2	
[213]	Cascade Pump 3	

5-41 On Delay, Relay		
Array [9], (Relay 1 [0], Relay 2 [1], Relay 3 [2], Relay 4 [3], Relay 5 [4], Relay 6 [5], Relay 7 [6], Relay 8 [7], Relay 9 [8])		
Range:	Function:	
0.01 s* [0.01 - 600.00 s]	Enter the delay of the relay cut-in time. Select one of available mechanical relays and MCB 105 in an array function. See 5-40 Function Relay. Relay 3-6 are included in MCB 113.	

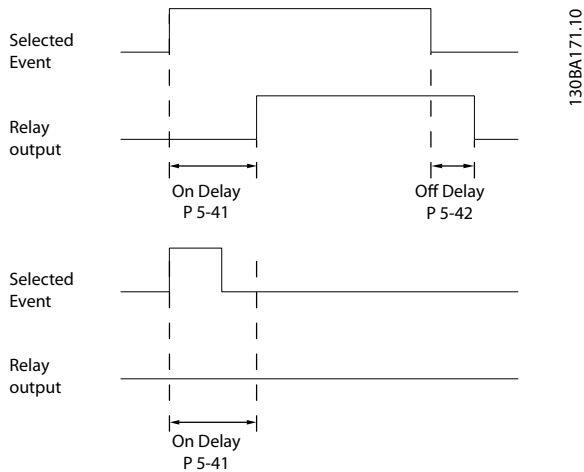

Figure 3.22

5-42 Off Delay, Relay		
Array [9] (Relay 1 [0], Relay 2 [1], Relay 3 [2], Relay 4 [3], Relay 5 [4], Relay 6 [5], Relay 7 [6], Relay 8 [7], Relay 9 [8])		
Range:	Function:	
0.01 s* [0.01 - 600.00 s]	Enter the delay of the relay cut-out time. Select one of available mechanical relays and MCB 105 in an array function. See 5-40 Function Relay.	

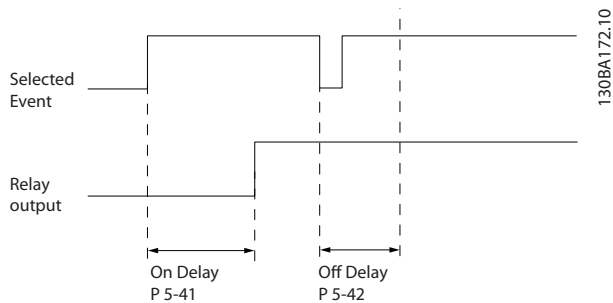

Figure 3.23

If the selected event condition changes before the on or off delay timer expires, the relay output is unaffected.

3.7.7 5-5* Pulse Input

The pulse input parameters are used to define an appropriate window for the impulse reference area by configuring the scaling and filter settings for the pulse inputs. Input terminals 29 or 33 act as frequency reference inputs. Set terminal 29 (5-13 Terminal 29 Digital Input) or terminal 33 (5-15 Terminal 33 Digital Input) to Pulse input [32]. If terminal 29 is used as an input, then set 5-02 Terminal 29 Mode to Input [0].

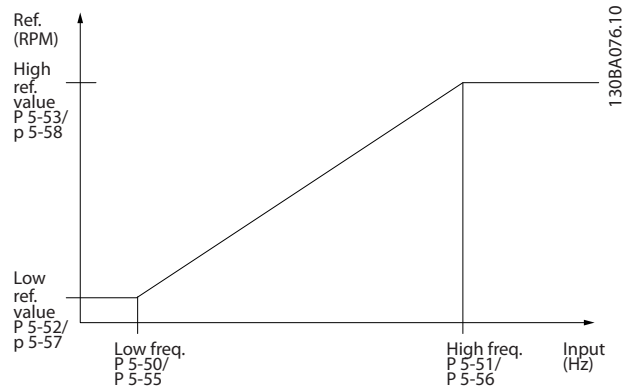

Figure 3.24

5-50 Term. 29 Low Frequency		
Range:	Function:	
100 Hz* [0 - 110000 Hz]	Enter the low frequency limit corresponding to the low motor shaft speed (i.e., low reference value) in 5-52 Term. 29 Low Ref./Feedb. Value. Refer to the diagram in this section.	

5-51 Term. 29 High Frequency		
Range:	Function:	
100 Hz* [0 - 110000 Hz]	Enter the high frequency limit corresponding to the high motor shaft speed (i.e. high reference value) in 5-53 Term. 29 High Ref./Feedb. Value.	

5-52 Term. 29 Low Ref./Feedb. Value		
Range:	Function:	
0.000 * [-999999.999 - 999999.999]	Enter the low reference value limit for the motor shaft speed [RPM]. This is also the lowest feedback value, see also 5-57 Term. 33 Low Ref./Feedb. Value.	

5-53 Term. 29 High Ref./Feedb. Value		
Range:	Function:	
100.000 * [-999999.999 - 999999.999]	Enter the high reference value [RPM] for the motor shaft speed and the high feedback value, see also 5-58 Term. 33 High Ref./Feedb. Value.	

5-54 Pulse Filter Time Constant #29		
Range:	Function:	
100 ms* [1 - 1000 ms]	Enter the pulse filter time constant. The pulse filter dampens oscillations of the feedback signal, which is an advantage if there is a lot of noise in the system. A high time constant value results in better damping, but also increases the time delay through the filter. This parameter cannot be adjusted while the motor is running.	

5-55 Term. 33 Low Frequency		
Range:	Function:	
100 Hz* [0 - 110000 Hz]	Enter the low frequency corresponding to the low motor shaft speed (i.e., low reference value) in 5-57 Term. 33 Low Ref./Feedb. Value.	

5-56 Term. 33 High Frequency		
Range:	Function:	
100 Hz* [0 - 110000 Hz]	Enter the high frequency corresponding to the high motor shaft speed (i.e., high reference value) in 5-58 Term. 33 High Ref./Feedb. Value.	

5-57 Term. 33 Low Ref./Feedb. Value		
Range:	Function:	
0.000 * [-999999.999 - 999999.999]	Enter the low reference value [RPM] for the motor shaft speed. This is also the low feedback value, see also 5-52 Term. 29 Low Ref./Feedb. Value.	

5-58 Term. 33 High Ref./Feedb. Value		
Range:	Function:	
100.000 * [-999999.999 - 999999.999]	Enter the high reference value [RPM] for the motor shaft speed. See also 5-53 Term. 29 High Ref./Feedb. Value.	

5-59 Pulse Filter Time Constant #33		
Range:	Function:	
100 ms* [1 - 1000 ms]	Enter the pulse filter time constant. The low-pass filter reduces the influence on, and dampens oscillations in, the feedback signal from the control. This is an advantage, if, for example, there is a great amount of noise in the system.	

NOTE!

This parameter cannot be adjusted while the motor is running.

3.7.8 5-6* Pulse Outputs

Parameters for configuring the scaling and output functions of pulse outputs. The pulse outputs are designated for terminals 27 or 29. Select terminal 27 output in 5-01 Terminal 27 Mode and terminal 29 output in 5-02 Terminal 29 Mode.

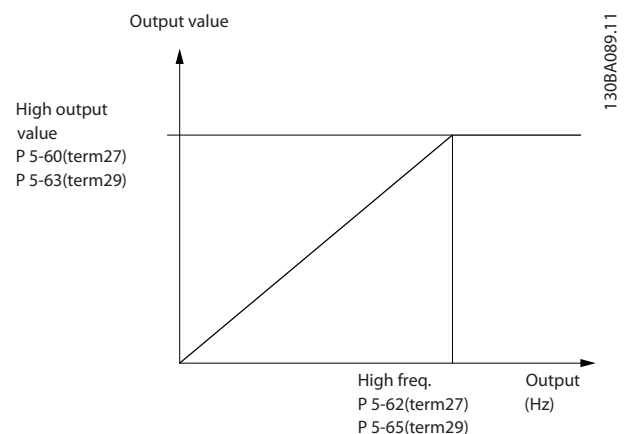

Figure 3.25

Options for readout output variables

- [0] No operation
- [45] Bus ctrl.
- [48] Bus ctrl. timeout
- [100] Output frequency
- [101] Reference
- [102] Feedback
- [103] Motor current
- [104] Torque relative to limit
- [105] Torque relative to rated
- [106] Power
- [107] Speed

- [108] Torque
- [109] Max. Out Freq.
- [113] Ext. Closed-Loop
- [114] Ext. Closed-Loop
- [115] Ext. Closed-Loop

Select the operation variable assigned for terminal 27 readouts.

This parameter cannot be adjusted while the motor is running. Same options and functions as parameter group 5-6*.

[0] *	No operation	
-------	--------------	--

5-62 Pulse Output Max Freq #27

Set the maximum frequency for terminal 27, corresponding to the output variable selected in *5-60 Terminal 27 Pulse Output Variable*.
This parameter cannot be adjusted while the motor is running.

Range: **Function:**

5000 Hz*	[0 - 32000 Hz]	
----------	----------------	--

5-63 Terminal 29 Pulse Output Variable

Select the variable for viewing on the terminal 29 display.
This parameter cannot be adjusted while the motor is running.
Same options and functions as parameter group 5-6*.

Option: **Function:**

[0] *	No operation	
[45]	Bus ctrl.	
[48]	Bus ctrl., timeout	
[100]	Output freq. 0-100	
[101]	Reference Min-Max	
[102]	Feedback +-200%	
[103]	Motor cur. 0-I _{max}	
[104]	Torque 0-T _{lim}	
[105]	Torque 0-T _{nom}	
[106]	Power 0-P _{nom}	
[107]	Speed 0-HighLim	
[113]	Ext. Closed-loop 1	
[114]	Ext. Closed-loop 2	
[115]	Ext. Closed-loop 3	

5-65 Pulse Output Max Freq #29

Set the maximum frequency for terminal 29 corresponding to the output variable set in *5-63 Terminal 29 Pulse Output Variable*.

Range: **Function:**

5000 Hz*	[0 - 32000 Hz]	
----------	----------------	--

5-66 Terminal X30/6 Pulse Output Variable

Select the variable for read-out on terminal X30/6.
This parameter is active when option module MCB 101 is installed in the Adjustable frequency drive.
Same options and functions as parameter group 5-6*.

Option: **Function:**

[0] *	No operation	
[45]	Bus ctrl.	
[48]	Bus ctrl., timeout	
[51]	MCO controlled	
[100]	Output frequency	
[101]	Reference	
[102]	Feedback	
[103]	Motor current	
[104]	Torque rel to limit	
[105]	Torq relate to rated	
[106]	Power	
[107]	Speed	
[108]	Torque	
[109]	Max Out Freq	
[119]	Torque % lim	

5-68 Pulse Output Max Freq #X30/6

Select the maximum frequency on terminal X30/6 referring to the output variable in *5-66 Terminal X30/6 Pulse Output Variable*.
This parameter cannot be adjusted while the motor is running.
This parameter is active when option module MCB 101 is mounted in the Adjustable frequency drive.

Range: **Function:**

Size related*	[0 - 32000 Hz]	
---------------	----------------	--

3.7.9 5-9* Bus Controlled

This parameter group selects digital and relay outputs via a serial communication bus setting.

5-90 Digital & Relay Bus Control

Range: **Function:**

0 *	[0 - 2147483647]	This parameter holds the state of the digital outputs and relays that is controlled by bus. A logical '1' indicates that the output is high or active. A logical '0' indicates that the output is low or inactive.
-----	-------------------	--

Bit 0	CC Digital Output Terminal 27
Bit 1	CC Digital Output Terminal 29
Bit 2	GPIO Digital Output Terminal X 30/6
Bit 3	GPIO Digital Output Terminal X 30/7
Bit 4	CC Relay 1 output terminal
Bit 5	CC Relay 2 output terminal
Bit 6	Option B Relay 1 output terminal
Bit 7	Option B Relay 2 output terminal
Bit 8	Option B Relay 3 output terminal
Bit 9-15	Reserved for future terminals
Bit 16	Option C Relay 1 output terminal
Bit 17	Option C Relay 2 output terminal
Bit 18	Option C Relay 3 output terminal
Bit 19	Option C Relay 4 output terminal
Bit 20	Option C Relay 5 output terminal
Bit 21	Option C Relay 6 output terminal
Bit 22	Option C Relay 7 output terminal
Bit 23	Option C Relay 8 output terminal
Bit 24-31	Reserved for future terminals

Table 3.14

5-93 Pulse Out #27 Bus Control		
Range:	Function:	
0.00 %*	[0.00 - 100.00 %]	

5-94 Pulse Out #27 Timeout Preset		
Range:	Function:	
0.00 %*	[0.00 - 100.00 %]	

5-95 Pulse Out #29 Bus Control		
Range:	Function:	
0.00 %*	[0.00 - 100.00 %]	

5-96 Pulse Out #29 Timeout Preset		
Range:	Function:	
0.00 %*	[0.00 - 100.00 %]	

5-97 Pulse Out #X30/6 Bus Control		
Range:	Function:	
0.00 %*	[0.00 - 100.00 %]	

5-98 Pulse Out #X30/6 Timeout Preset		
Range:	Function:	
0.00 %*	[0.00 - 100.00 %]	

3.8 Main Menu - Analog In/Out - Group 6

3.8.1 6-0* Analog I/O Mode

Parameter group for setting up the analog I/O configuration.

The Adjustable frequency drive is equipped with 2 analog inputs: Terminal 53 and 54. The analog inputs can freely be allocated to either voltage (0–10V) or current input (0/4–20mA)

NOTE!

Thermistors may be connected to either an analog or a digital input.

6-00 Live Zero Timeout Time	
Range:	Function:
10 s* [1 - 99 s]	Enter the Live Zero Timeout time period. Live Zero Timeout Time is active for analog inputs, i.e., terminal 53 or terminal 54, used as reference or feedback sources. If the reference signal value associated with the selected current input falls below 50% of the value set in 6-10 Terminal 53 Low Voltage, 6-12 Terminal 53 Low Current, 6-20 Terminal 54 Low Voltage or 6-22 Terminal 54 Low Current for a time period longer than the time set in 6-00 Live Zero Timeout Time, the function selected in 6-01 Live Zero Timeout Function will be activated.

6-01 Live Zero Timeout Function	
Option:	Function:
	Select the timeout function. The function set in 6-01 Live Zero Timeout Function will be activated if the input signal on terminal 53 or 54 is below 50% of the value in 6-10 Terminal 53 Low Voltage, 6-12 Terminal 53 Low Current, 6-20 Terminal 54 Low Voltage or 6-22 Terminal 54 Low Current for a time period defined in 6-00 Live Zero Timeout Time. If several timeouts occur simultaneously, the Adjustable frequency drive prioritizes the timeout functions as follows: <ol style="list-style-type: none"> 6-01 Live Zero Timeout Function 8-04 Control Timeout Function The output frequency of the adjustable frequency drive can be: <ul style="list-style-type: none"> [1] frozen at the present value [2] overruled to stop [3] overruled to jog speed

6-01 Live Zero Timeout Function	
Option:	Function:
	<ul style="list-style-type: none"> [4] overruled to max. speed [5] overruled to stop with subsequent trip
[0] *	Off
[1]	Freeze output
[2]	Stop
[3]	Jogging
[4]	Max. speed
[5]	Stop and trip

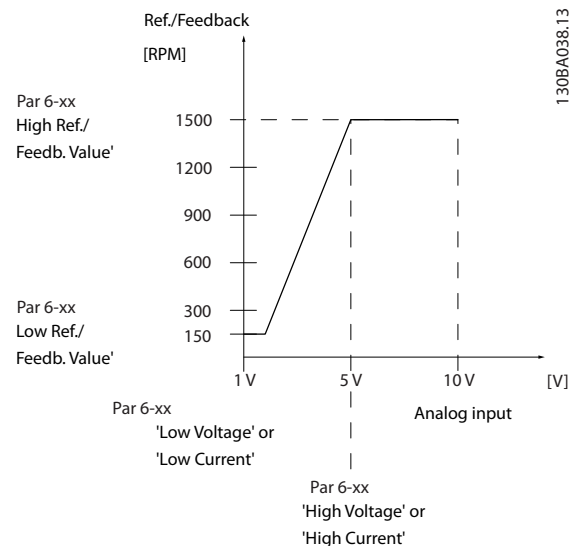

Figure 3.26

6-02 Fire Mode Live Zero Timeout Function	
Option:	Function:
	The function set in 6-01 Live Zero Timeout Function will be activated if the input signal on analog inputs is below 50% of the value defined in parameter group 6-1* to 6-6* "Terminal xx Low Current" or "Terminal xx Low Voltage" for a time period defined in 6-00 Live Zero Timeout Time.
[0] *	Off
[1]	Freeze output
[2]	Stop
[3]	Jogging
[4]	Max. speed

3.8.2 6-1* Analog Input 1

Parameters for configuring the scaling and limits for analog input 1 (terminal 53).

6-10 Terminal 53 Low Voltage		
Range:	Function:	
0.07 V* [0.00 - par. 6-11 V]	Enter the low voltage value. This analog input scaling value should correspond to the low reference/feedback value set in <i>6-14 Terminal 53 Low Ref./Feedb. Value</i> .	

6-11 Terminal 53 High Voltage		
Range:	Function:	
10.00 V* [par. 6-10 - 10.00 V]	Enter the high voltage value. This analog input scaling value should correspond to the high reference/feedback value set in <i>6-15 Terminal 53 High Ref./Feedb. Value</i> .	

6-12 Terminal 53 Low Current		
Range:	Function:	
4.00 mA* [0.00 - par. 6-13 mA]	Enter the low current value. This reference signal should correspond to the low reference/feedback value, set in <i>6-14 Terminal 53 Low Ref./Feedb. Value</i> . The value must be set at >2 mA in order to activate the Live Zero Timeout Function in <i>6-01 Live Zero Timeout Function</i> .	

6-13 Terminal 53 High Current		
Range:	Function:	
20.00 mA* [par. 6-12 - 20.00 mA]	Enter the high current value corresponding to the high reference/feedback set in <i>6-15 Terminal 53 High Ref./Feedb. Value</i> .	

6-14 Terminal 53 Low Ref./Feedb. Value		
Range:	Function:	
0.000 * [-999999.999 - 999999.999]	Enter the analog input scaling value that corresponds to the low voltage/low current set in <i>6-10 Terminal 53 Low Voltage</i> and <i>6-12 Terminal 53 Low Current</i> .	

6-15 Terminal 53 High Ref./Feedb. Value		
Range:	Function:	
Size related* [-999999.999 - 999999.999]		

6-16 Terminal 53 Filter Time Constant		
Range:	Function:	
0.001 s* [0.001 - 10.000 s]	Enter the time constant. This is a first-order digital low pass filter time constant for suppressing electrical noise in terminal 53. A high time constant value improves dampening but also increases the time delay through the filter.	

NOTE!

This parameter cannot be adjusted while the motor is running.

6-17 Terminal 53 Live Zero		
Option:	Function:	
[0]	Disabled	This parameter makes it possible to disable the Live Zero monitoring. For example, this is to be used if the analog outputs are used as part of a de-central I/O system (e.g., when not used as part of any adjustable frequency drive related control functions, but for feeding a building management system with data).
[1] *	Enabled	

3.8.3 6-2* Analog Input 2

Parameters for configuring the scaling and limits for analog input 2 (terminal 54).

6-20 Terminal 54 Low Voltage		
Range:	Function:	
0.07 V* [0.00 - par. 6-21 V]	Enter the low voltage value. This analog input scaling value should correspond to the low reference/feedback value, set in <i>6-24 Terminal 54 Low Ref./Feedb. Value</i> .	

6-21 Terminal 54 High Voltage		
Range:	Function:	
10.00 V* [par. 6-20 - 10.00 V]	Enter the high voltage value. This analog input scaling value should correspond to the high reference/feedback value set in <i>6-25 Terminal 54 High Ref./Feedb. Value</i> .	

6-22 Terminal 54 Low Current		
Range:	Function:	
4.00 mA* [0.00 - par. 6-23 mA]	Enter the low current value. This reference signal should correspond to the low reference/feedback value, set in <i>6-24 Terminal 54 Low Ref./Feedb. Value</i> . The value must be set at >2 mA in order to activate the Live Zero Timeout Function in <i>6-01 Live Zero Timeout Function</i> .	

6-23 Terminal 54 High Current		
Range:	Function:	
20.00 mA* [par. 6-22 - 20.00 mA]	Enter the high current value corresponding to the high reference/feedback value set in <i>6-25 Terminal 54 High Ref./Feedb. Value</i> .	

6-24 Terminal 54 Low Ref./Feedb. Value		
Range:	Function:	
0.000 * [-999999.999 - 999999.999]	Enter the analog input scaling value that corresponds to the low voltage/low current value set in <i>6-20 Terminal 54 Low Voltage</i> and <i>6-22 Terminal 54 Low Current</i> .	

6-25 Terminal 54 High Ref./Feedb. Value		
Range:	Function:	
100.000 * [-999999.999 - 999999.999]	Enter the analog input scaling value that corresponds to the high voltage/high current value set in <i>6-21 Terminal 54 High</i>	

6-25 Terminal 54 High Ref./Feedb. Value		
Range:	Function:	
	<i>Voltage and 6-23 Terminal 54 High Current</i> .	

6-26 Terminal 54 Filter Time Constant		
Range:	Function:	
0.001 s* [0.001 - 10.000 s]	Enter the time constant. This is a first-order digital low pass filter time constant for suppressing electrical noise in terminal 54. A high time constant value improves dampening but also increases the time delay through the filter.	

NOTE!

This parameter cannot be adjusted while the motor is running.

6-27 Terminal 54 Live Zero		
Option:	Function:	
	This parameter makes it possible to disable the Live Zero monitoring. For example, this to be used if the analog outputs are used as part of a de-central I/O system (e.g., when used not as part of any adjustable frequency drive related control functions, but for feeding a building management system with data).	
[0]	Disabled	
[1] *	Enabled	

3.8.4 6-3* Analog Input 3 MCB 101

Parameter group for configuring the scale and limits for analog input 3 (X30/11) placed on option module MCB 101.

6-30 Terminal X30/11 Low Voltage		
Range:	Function:	
0.07 V* [0.00 - par. 6-31 V]	Sets the analog input scaling value to correspond to the low reference/feedback value (set in <i>6-34 Term. X30/11 Low Ref./Feedb. Value</i>).	

6-31 Terminal X30/11 High Voltage		
Range:	Function:	
10.00 V* [par. 6-30 - 10.00 V]	Sets the analog input scaling value to correspond to the high reference/feedback value (set in <i>6-35 Term. X30/11 High Ref./Feedb. Value</i>).	

6-34 Term. X30/11 Low Ref./Feedb. Value		
Range:	Function:	
0.000 * [-999999.999 - 999999.999]	Sets the analog input scaling value to correspond to the low voltage value (set in 6-30 Terminal X30/11 Low Voltage).	

6-35 Term. X30/11 High Ref./Feedb. Value		
Range:	Function:	
100.000 * [-999999.999 - 999999.999]	Sets the analog input scaling value to correspond to the high voltage value (set in 6-31 Terminal X30/11 High Voltage).	

6-36 Term. X30/11 Filter Time Constant		
Range:	Function:	
0.001 s* [0.001 - 10.000 s]	A 1 st order digital low pass filter time constant for suppressing electrical noise on terminal X30/11.	

NOTE!

This parameter cannot be changed while the motor is running.

6-37 Term. X30/11 Live Zero		
Option:	Function:	
[0] * Disabled	This parameter makes it possible to disable Live Zero monitoring. For example, this may be used if the analog outputs are used as part of a decentral I/O system (e.g., when not part of any adjustable frequency drive-related control functions, but feeding a building management system with data).	
[1] * Enabled		

3.8.5 6-4* Analog Input 4 MCB 101

Parameter group for configuring the scale and limits for analog input 4 (X30/12) placed on option module MCB 101.

6-40 Terminal X30/12 Low Voltage		
Range:	Function:	
0.07 V* [0.00 - par. 6-41 V]	Sets the analog input scaling value to correspond to the low reference/feedback value set in 6-44 Term. X30/12 Low Ref./Feedb. Value.	

6-41 Terminal X30/12 High Voltage		
Range:	Function:	
10.00 V* [par. 6-40 - 10.00 V]	Sets the analog input scaling value to correspond to the high reference/feedback value set in 6-45 Term. X30/12 High Ref./Feedb. Value.	

6-44 Term. X30/12 Low Ref./Feedb. Value		
Range:	Function:	
0.000 * [-999999.999 - 999999.999]	Sets the analog output scaling value to correspond to the low voltage value set in 6-40 Terminal X30/12 Low Voltage.	

6-45 Term. X30/12 High Ref./Feedb. Value		
Range:	Function:	
100.000 * [-999999.999 - 999999.999]	Sets the analog input scaling value to correspond to the high voltage value set in 6-41 Terminal X30/12 High Voltage.	

6-46 Term. X30/12 Filter Time Constant		
Range:	Function:	
0.001 s* [0.001 - 10.000 s]	A 1 st order digital low pass filter time constant for suppressing electrical noise on terminal X30/12.	

NOTE!

This parameter cannot be changed while the motor is running.

6-47 Term. X30/12 Live Zero		
Option:	Function:	
[0] * Disabled	This parameter makes it possible to disable Live Zero monitoring. For example, this may be used if the analog outputs are used as part of a decentral I/O system (e.g., when not part of any adjustable frequency drive-related control functions, but feeding a building management system with data).	
[1] Enabled		

3.8.6 6-5* Analog Output 1

Parameters for configuring the scaling and limits for analog output 1, i.e., Terminal 42. Analog outputs are current outputs: 0/4-20mA. Common terminal (terminal 39) is the same terminal and has the same electrical potential for analog common and digital common connection. Resolution on analog output is 12 bit.

6-50 Terminal 42 Output		
Option:	Function:	
		Select the function of Terminal 42 as an analog current output. A motor current of 20 mA corresponds to I_{max} .
[0]	No operation	
[100]	Output freq. 0-100	0–100 Hz, (0–20 mA)
[101]	Reference Min-Max	Minimum reference - Maximum reference, (0–20 mA)
[102]	Feedback +-200%	-200% to +200% of 20-14 Maximum Reference/Feedb., (0–20 mA)
[103]	Motor cur. 0-I _{max}	0 - Inverter Max. Current (16-37 Inv. Max. Current), (0–20 mA)
[104]	Torque 0-Tlim	0 - Torque limit (4-16 Torque Limit Motor Mode), (0–20 mA)
[105]	Torque 0-Tnom	0 - Motor rated torque, (0–20 mA)
[106]	Power 0-Pnom	0 - Motor rated power, (0–20 mA)
[107]	Speed 0-HighLim	0 - Speed High Limit (4-13 Motor Speed High Limit [RPM] and 4-14 Motor Speed High Limit [Hz]), (0–20 mA)
[113]	Ext. Closed-loop 1	0–100%, (0–20 mA)
[114]	Ext. Closed-loop 2	0–100%, (0–20 mA)
[115]	Ext. Closed-loop 3	0–100%, (0–20 mA)
[130]	Out fr 0-100 4-20	0–100 Hz
[131]	Reference 4-20mA	Minimum Reference - Maximum Reference
[132]	Feedback 4-20mA	-200% to +200% of 20-14 Maximum Reference/Feedb.
[133]	Motor cur. 4-20mA	0 - Inverter Max. Current (16-37 Inv. Max. Current)
[134]	Torq.0-lim 4-20mA	0 - Torque limit (4-16 Torque Limit Motor Mode)
[135]	Torq.0-nom 4-20mA	0 - Motor rated torque
[136]	Power 4-20mA	0 - Motor rated power
[137] *	Speed 4-20mA	0 - Speed High Limit (4-13 and 4-14)
[139]	Bus ctrl.	0–100%, (0–20 mA)
[140]	Bus ctrl. 4-20 mA	0–100%
[141]	Bus ctrl t.o.	0–100%, (0–20 mA)
[142]	Bus ctrl 4-20mA t.o.	0–100%
[143]	Ext. CL 1 4-20 mA	0–100%

6-50 Terminal 42 Output		
Option:	Function:	
[144]	Ext. CL 2 4-20 mA	0–100%
[145]	Ext. CL 3 4-20 mA	0–100%

NOTE!

Values for setting the minimum reference are found in open-loop 3-02 Minimum Reference and for closed-loop 20-13 Minimum Reference/Feedb. - values for maximum reference for open-loop are found in 3-03 Maximum Reference and for closed-loop 20-14 Maximum Reference/Feedb..

6-51 Terminal 42 Output Min Scale		
Range:	Function:	
0.00 %*	[0.00 - 200.00 %]	

6-52 Terminal 42 Output Max Scale		
Range:	Function:	
100.00 %*	[0.00 - 200.00 %]	

$20 \text{ mA} / \text{desired maximum current} \times 100 \%$

i.e. $10 \text{ mA} : \frac{20 \text{ mA}}{10 \text{ mA}} \times 100 \% = 200 \%$

EXAMPLE 1:

Variable value= OUTPUT FREQUENCY, range = 0–100 Hz

Range needed for output = 0-50Hz

Output signal 0 or 4mA is needed at 0Hz (0% of range) -

set 6-51 Terminal 42 Output Min Scale to 0%

Output signal 20mA is needed at 50Hz (50% of range) - set

6-52 Terminal 42 Output Max Scale to 50%

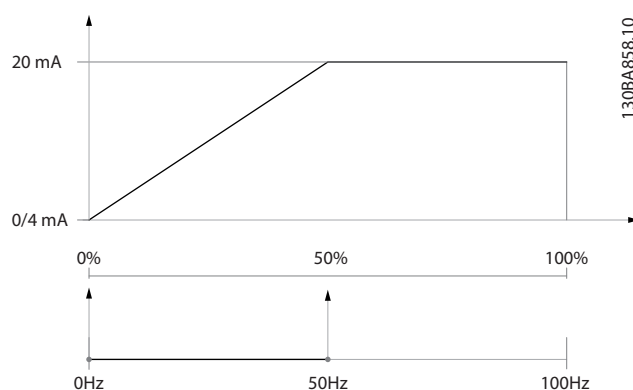

Figure 3.28

EXAMPLE 2:

Variable= FEEDBACK, range= -200% to +200%
 Range needed for output= 0-100%
 Output signal 0 or 4mA is needed at 0% (50% of range) -
 set 6-51 Terminal 42 Output Min Scale to 50%
 Output signal 20mA is needed at 100% (75% of range) -
 set 6-52 Terminal 42 Output Max Scale to 75%

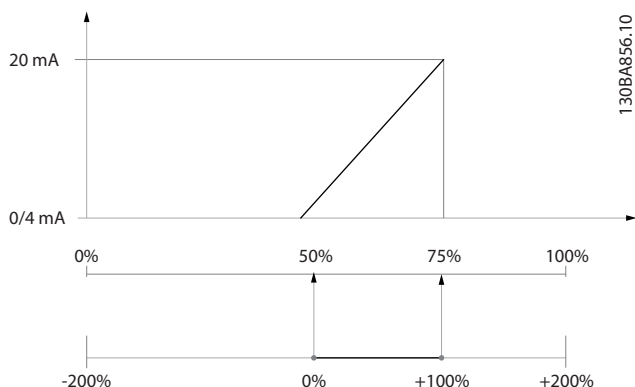

Figure 3.29

EXAMPLE 3:

Variable value= REFERENCE, range= Min ref - Max ref
 Range needed for output= Min ref (0%) - Max ref (100%),
 0-10 mA
 Output signal 0 or 4mA is needed at Min ref - set
 6-51 Terminal 42 Output Min Scale to 0%
 Output signal 10mA is needed at Max ref (100% of range) -
 set 6-52 Terminal 42 Output Max Scale to 200%
 (20mA/10mA x 100%=200%).

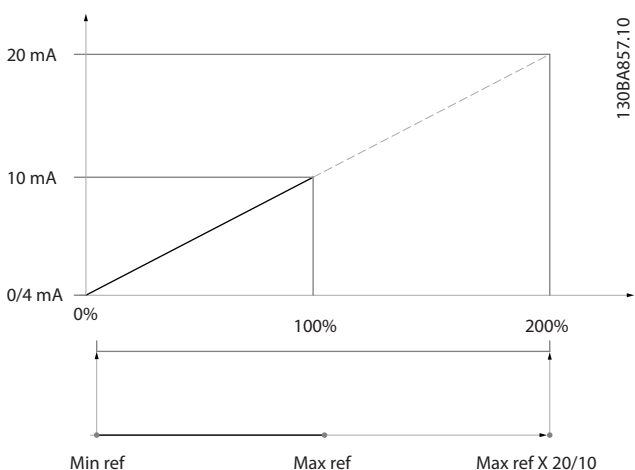

Figure 3.30

6-54 Terminal 42 Output Timeout Preset

Range:	Function:
0.00 %*	[0.00 - 100.00 %]

3.8.7 6-6* Analog Output 2 MCB 101

Analog outputs are current outputs: 0/4 - 20mA. Common terminal (terminal X30/8) is the same terminal and electrical potential for analog common connection. Resolution on analog output is 12 bit.

6-60 Terminal X30/8 Output

Same options and functions as 6-50 Terminal 42 Output.

Option:	Function:
[0] *	No operation

6-61 Terminal X30/8 Min. Scale

Range:	Function:
0.00 %*	[0.00 - 200.00 %]

6-62 Terminal X30/8 Max. Scale

Range:	Function:
100.00 %*	[0.00 - 200.00 %]

6-63 Terminal X30/8 Output Bus Control

Range:	Function:
0.00 %*	[0.00 - 100.00 %]

6-64 Terminal X30/8 Output Timeout Preset

Range:	Function:
0.00 %*	[0.00 - 100.00 %]

6-53 Terminal 42 Output Bus Control

Range:	Function:
0.00 %*	[0.00 - 100.00 %]

3.9 Main Menu - Communications and Options - Group 8

3.9.1 8-0* General Settings

8-01 Control Site		
Option:	Function:	
	The setting in this parameter overrides the settings in <i>8-50 Coasting Select</i> to <i>8-56 Preset Reference Select</i> .	
[0] *	Digital and ctrl. word	Control by using both digital input and control word.
[1]	Digital only	Control by using digital inputs only.
[2]	Control word only	Control by using control word only.

8-02 Control Source		
Option:	Function:	
	Select the source of the control word: one of two serial interfaces or four installed options. During initial power-up, the adjustable frequency drive automatically sets this parameter to <i>Option A</i> [3] if it detects a valid serial communication bus option installed in slot A. If the option is removed, the adjustable frequency drive detects a change in the configuration, sets <i>8-02 Control Source</i> back to default setting <i>Adjustable Frequency Drive Port</i> , and the adjustable frequency drive then trips. If an option is installed after initial power-up, the setting of <i>8-02 Control Source</i> will not change but the adjustable frequency drive will trip and display: <i>Alarm 67 Option Changed</i> .	
[0]	None	
[1]	FC RS-485	
[2]	FC USB	
[3] *	Option A	
[4]	Option B	
[5]	Option C0	
[6]	Option C1	
[30]	External Can	

NOTE!

This parameter cannot be adjusted while the motor is running.

8-03 Control Timeout Time		
Range:	Function:	
Size related*	[1.0 - 18000.0 s]	

8-04 Control Timeout Function		
Option:	Function:	
	Select the timeout function. The timeout function is activated when the control word fails to be updated within the time period specified in <i>8-03 Control Timeout Time</i> . Choice [20] only appears after setting the Metasys N2 protocol.	
[0] *	Off	
[1]	Freeze output	
[2]	Stop	
[3]	Jogging	
[4]	Max. speed	
[5]	Stop and trip	
[7]	Select setup 1	
[8]	Select setup 2	
[9]	Select setup 3	
[10]	Select setup 4	
[20]	N2 Override Release	

8-05 End-of-Timeout Function		
Option:	Function:	
	Select the action after receiving a valid control word following a timeout. This parameter is active only when <i>8-04 Control Timeout Function</i> is set to [Set-up 1-4].	
[0]	Hold set-up	Retains the set-up selected in <i>8-04 Control Timeout Function</i> and displays a warning, until <i>8-06 Reset Control Timeout</i> toggles. Then the Adjustable frequency drive resumes its original set-up.
[1] *	Resume set-up	Resumes the set-up active prior to the timeout.

8-06 Reset Control Timeout		
Option:	Function:	
	This parameter is active only when the choice <i>Hold set-up</i> [0] has been selected in <i>8-05 End-of-Timeout Function</i> .	
[0] *	Do not reset	Retains the set-up specified in <i>8-04 Control Timeout Function</i> , [Select set-up 1-4] following a control timeout.
[1]	Do reset	Returns the adjustable frequency drive to the original set-up following a control word timeout. When the value is set to <i>Do reset</i> [1], the adjustable frequency drive performs the reset and then immediately reverts to the <i>Do not reset</i> [0] setting.

8-07 Diagnosis Trigger		
Option:	Function:	
		This parameter has no function for BACnet.
[0] *	Disable	
[1]	Trigger on alarms	
[2]	Trigger alarm/warn.	

3.9.2 8-1* Ctrl. Word Settings

8-10 Control Profile		
Option:	Function:	
		Select the interpretation of the control and status words corresponding to the installed serial communication bus. Only the selections valid for the serial communication bus installed in slot A will be visible in the LCP display.
[0] *	FC profile	
[1]	PROFIdrive profile	
[5]	ODVA	
[7]	CANopen DSP 402	

8-13 Configurable Status Word STW		
Option:	Function:	
		This parameter enables configuration of bits 12 – 15 in the status word.
[0]	No function	The input is always low.
[1] *	Profile Default	Depended on the profile set in 8-10 Control Profile.
[2]	Alarm 68 Only	The input will go high whenever Alarm 68 is active and will go low whenever no alarm 68 is active
[3]	Trip excl Alarm 68	The input will go high whenever Trip on other alarms is active, and then Alarm 68 is active.
[10]	T18 DI status.	The input will go high whenever T18 has 24 V and will go low whenever T18 has 0 V.
[11]	T19 DI status.	The input will go high whenever T19 has 24 V and will go low whenever T19 has 0 V.
[12]	T27 DI status.	The input will go high whenever T27 has 24 V and will go low whenever T27 has 0 V.
[13]	T29 DI status.	The input will go high whenever T29 has 24 V and will go low whenever T29 has 0 V.

8-13 Configurable Status Word STW		
Option:	Function:	
[14]	T32 DI status.	The input will go high whenever T32 has 24 V and will go low whenever T32 has 0 V.
[15]	T33 DI status.	The input will go high whenever T33 has 24 V and will go low whenever T33 has 0 V.
[16]	T37 DI status	The input will go high whenever T37 has 0 V and will go low whenever T37 has 24 V
[21]	Thermal warning	The thermal warning turns on when the temperature exceeds the limit in the motor, the adjustable frequency drive, the brake resistor, or the thermistor.
[30]	Brake fault (IGBT)	Will go high when the brake IGBT is short-circuited.
[40]	Out of ref range	If Comparator 0 is evaluated as TRUE, the input will go high. Otherwise, it will be low.
[60]	Comparator 0	If Comparator 0 is evaluated as TRUE, the input will go high. Otherwise, it will be low.
[61]	Comparator 1	If Comparator 1 is evaluated as TRUE, the input will go high. Otherwise, it will be low.
[62]	Comparator 2	If Comparator 2 is evaluated as TRUE, the input will go high. Otherwise, it will be low.
[63]	Comparator 3	If Comparator 3 is evaluated as TRUE, the input will go high. Otherwise, it will be low.
[64]	Comparator 4	If Comparator 4 is evaluated as TRUE, the input will go high. Otherwise, it will be low.
[65]	Comparator 5	If Comparator 5 is evaluated as TRUE, the input will go high. Otherwise, it will be low.
[70]	Logic Rule 0	If Logic Rule 0 is evaluated as TRUE, the input will go high. Otherwise, it will be low.
[71]	Logic Rule 1	If Logic Rule 1 is evaluated as TRUE, the input will go high. Otherwise, it will be low.
[72]	Logic Rule 2	If Logic Rule 2 is evaluated as TRUE, the input will go high. Otherwise, it will be low.
[73]	Logic Rule 3	If Logic Rule 3 is evaluated as TRUE, the input will go high. Otherwise, it will be low.
[74]	Logic Rule 4	If Logic Rule 4 is evaluated as TRUE, the input will go high. Otherwise, it will be low.

8-13 Configurable Status Word STW		
Option:	Function:	
[75]	Logic Rule 5	If Logic Rule 5 is evaluated as TRUE, the input will go high. Otherwise, it will be low.
[80]	SL Digital Output A	SL Controller Action. The input will go high whenever the Smart Logic Action [38] Set dig. out. A high is executed. The input will go low whenever the Smart Logic Action [32] Set dig. out. A low is executed.
[81]	SL Digital Output B	SL Controller Action. The input will go high whenever the Smart Logic Action [39] Set dig. out. A high is executed. The input will go low whenever the Smart Logic Action [33] Set dig. out. A low is executed.
[82]	SL Digital Output C	SL Controller Action. The input will go high whenever the Smart Logic Action [40] Set dig. out. A high is executed. The input will go low whenever the Smart Logic Action [34] Set dig. out. A low is executed.
[83]	SL Digital Output D	SL Controller Action. The input will go high whenever the Smart Logic Action [41] Set dig. out. A high is executed. The input will go low whenever the Smart Logic Action [35] Set dig. out. A low is executed.
[84]	SL Digital Output E	SL Controller Action. The input will go high whenever the Smart Logic Action [42] Set dig. out. A high is executed. The input will go low whenever the Smart Logic Action [36] Set dig. out. A low is executed.
[85]	SL Digital Output F	SL Controller Action. The input will go high whenever the Smart Logic Action [43] Set dig. out. A high is executed. The input will go low whenever the Smart Logic Action [37] Set dig. out. A low is executed.

8-30 Protocol		
Option:	Function:	
[0] *	FC	Communication according to the FC Protocol as described in the <i>VLT[®] HVAC Drive Design Guide, RS485 Installation and Set-up.</i>
[1]	FC MC	Same as FC [0] but to be used when downloading SW to the adjustable frequency drive or uploading dll file (covering information regarding parameters available in the adjustable frequency drive and their interdependencies) to Motion Control Tool MCT10.
[2]	Modbus RTU	Communication according to the Modbus RTU protocol as described in the <i>VLT[®] HVAC Drive Design Guide, RS485 Installation and Set-up.</i>
[3]	Metasys N2	Communication protocol. The N2 software protocol is designed to be general in nature in order to accommodate the unique properties each device may have. Please see separate manual <i>VLT[®] HVAC Drive Metasys MG.11.GX.YY.</i>
[4]	FLN	Communication according to the Apogee FLN P1 protocol.
[5]	BACnet	Communication according to an open data communications protocol (Building Automation and Control Network), American National Standard (ANSI/ASHRAE 135-1995).
[9]	FC Option	To be used when a gateway is connected to the integrated RS485 port, e.g., the BACnet gateway. The following changes will take place: - Address for the FC port will be set to 1 and <i>8-31 Address</i> is now used to set the address for the gateway on the network, e.g., BACnet. Please see separate manual <i>VLT[®] HVAC Drive BACnet, MG.11.DX.YY.</i> -The baud rate for the FC port will be set to a fixed value (115,200 Baud) and <i>8-32 Baud Rate</i> , is now used to set the baud rate for the network port (e.g., BACnet) on the gateway.
[20]	LEN	

3.9.3 8-3* FC Port Settings

8-30 Protocol		
Option:	Function:	
		Protocol selection for the integrated FC (standard) Port (RS485) on the control card. Parameter group 8-7* is only visible when FC Option [9] is chosen.

NOTE!

Further details can be found in the Metasys manual, MG.11.GX.YY.

8-31 Address		
Range:	Function:	
Size related*	[1. - 255.]	Enter the address for the FC (standard) port. Valid range: 1 - 126.

8-32 Baud Rate		
Option:	Function:	
		Baud rates 9600, 19200, 38400 and 76800 baud are valid for BACnet only.
[0]	2400 Baud	
[1]	4800 Baud	
[2] *	9600 Baud	
[3]	19200 Baud	
[4]	38400 Baud	
[5]	57600 Baud	
[6]	76800 Baud	
[7]	115200 Baud	

Default refers to the FC protocol.

8-33 Parity / Stop Bits		
Option:	Function:	
		Parity and Stop Bits for the protocol <i>8-30 Protocol</i> using the FC Port. For some of the protocols, not all options will be visible. Default depends on the protocol selected.
[0] *	Even Parity, 1 Stop Bit	
[1]	Odd Parity, 1 Stop Bit	
[2]	No Parity, 1 Stop Bit	
[3]	No Parity, 2 Stop Bits	

8-34 Estimated cycle time		
Range:	Function:	
0 ms* [0 - 1000000 ms]	In a noisy environments, the interface may be blocked by due to overload of bad frames. This parameter specifies the time between two consecutive frames on the network. If the interface does not detect valid frames in that time it flushes the receive buffer.	

8-35 Minimum Response Delay		
Range:	Function:	
Size related* [5. - 10000. ms]		

8-36 Maximum Response Delay		
Range:	Function:	
Size related* [11. - 10001. ms]		

8-37 Maximum Inter-Char Delay		
Range:	Function:	
Size related* [0.00 - 35.00 ms]		

3.9.4 8-4* Message Selection

8-40 Telegram selection		
Option:	Function:	
		Enables use of freely configurable messages or standard messages for the FC port.
[1] *	Standard telegram 1	
[101]	PPO 1	
[102]	PPO 2	
[103]	PPO 3	
[104]	PPO 4	
[105]	PPO 5	
[106]	PPO 6	
[107]	PPO 7	
[108]	PPO 8	
[200]	Custom telegram 1	

8-42 PCD write configuration		
Range:	Function:	
Size related* [0 - 9999]		

8-43 PCD read configuration		
Range:	Function:	
Size related* [0 - 9999]		

3.9.5 8-5* Digital/Bus

Parameters for configuring the control word Digital/Bus merging.

NOTE!

These parameters are active only when *8-01 Control Site* is set to [0] *Digital and control word*.

8-50 Coasting Select		
Option:	Function:	
		Select control of the coasting function via the terminals (digital input) and/or via the bus.
[0]	Digital input	Activates Start command via a digital input.
[1]	Bus	Activates Start command via the serial communication port or serial communication option.
[2]	Logic AND	Activates Start command via the serial communication bus/serial communication port, AND additionally via one of the digital inputs.
[3] *	Logic OR	Activates Start command via the serial communication bus/serial communication port OR via one of the digital inputs.

8-52 DC Brake Select		
Option:	Function:	
		Select control of the DC brake via the terminals (digital input) and/or via the serial communication bus. NOTE! Only selection [0] Digital input is available when 1-10 Motor Construction is set to [1] PM non-salient SPM.
[0]	Digital input	Activates Start command via a digital input.
[1]	Bus	Activates Start command via the serial communication port or serial communication option.
[2]	Logic AND	Activates Start command via the serial communication bus/serial communication port, AND additionally via one of the digital inputs.
[3] *	Logic OR	Activates Start command via the serial communication bus/serial communication port OR via one of the digital inputs.

8-53 Start Select		
Option:	Function:	
		Select control of the Adjustable frequency drive start function via the terminals (digital input) and/or via the serial communication bus.
[0]	Digital input	Activates Start command via a digital input.
[1]	Bus	Activates Start command via the serial communication port or serial communication option.
[2]	Logic AND	Activates Start command via the serial communication bus/serial communication port, AND additionally via one of the digital inputs.
[3] *	Logic OR	Activates Start command via the serial communication bus/serial communication port OR via one of the digital inputs.

8-54 Reverse Select		
Option:	Function:	
		Select control of the adjustable frequency drive reverse function via the terminals (digital input) and/or via the serial communication bus.
[0] *	Digital input	Activates Reverse command via a digital input.
[1]	Bus	Activates Reverse command via the serial communication port or serial communication option.

8-54 Reverse Select		
Option:	Function:	
[2]	Logic AND	Activates Reverse command via the serial communication bus/serial communication port, AND additionally via one of the digital inputs.
[3]	Logic OR	Activates Reverse command via the serial communication bus/serial communication port OR via one of the digital inputs.

NOTE!

This parameter is active only when 8-01 Control Site is set to [0] *Digital and control word*.

8-55 Set-up Select		
Option:	Function:	
		Select control of the Adjustable frequency drive set-up selection via the terminals (digital input) and/or via the serial communication bus.
[0]	Digital input	Activates the set-up selection via a digital input.
[1]	Bus	Activates the set-up selection via the serial communication port or serial communication option.
[2]	Logic AND	Activates the set-up selection via the serial communication bus/serial communication port, AND additionally via one of the digital inputs.
[3] *	Logic OR	Activate the set-up selection via the serial communication bus/serial communication port OR via one of the digital inputs.

8-56 Preset Reference Select		
Option:	Function:	
		Select control of the Adjustable frequency drive Preset Reference selection via the terminals (digital input) and/or via the serial communication bus.
[0]	Digital input	Activates Preset Reference selection via a digital input.
[1]	Bus	Activates Preset Reference selection via the serial communication port or serial communication option.
[2]	Logic AND	Activates Preset Reference selection via the serial communication bus/serial communication port, AND additionally via one of the digital inputs.
[3] *	Logic OR	Activates the Preset Reference selection via the serial communication bus/serial communication port OR via one of the digital inputs.

3.9.6 8-7* BACnet

8-70 BACnet Device Instance		
Range:	Function:	
1 *	[0 - 4194302]	Enter a unique ID number for the BACnet device.

8-72 MS/TP Max Masters		
Range:	Function:	
127 *	[1 - 127]	Define the address of the master which holds the highest address in this network. Decreasing this value optimizes polling for the token.

NOTE!

This parameter is active only when 8-30 Protocol is set to [9] Adjustable Frequency Drive Option.

8-73 MS/TP Max Info Frames		
Range:	Function:	
1 *	[1 - 65534]	Define how many info/data frames the device is allowed to send while holding the token.

NOTE!

This parameter is active only when 8-30 Protocol is set to [9] Adjustable Frequency Drive Option.

8-74 "I-Am" Service		
Option:	Function:	
[0] *	Send at power-up	
[1]	Continuously	Choose whether the device should send the "I-Am" service message only at power-up or continuously with an interval of approx. 1 min.

NOTE!

This parameter is active only when 8-30 Protocol is set to [9] Adjustable Frequency Drive Option.

8-75 Initialization Password		
Range:	Function:	
Size related*	[1 - 1]	Enter the password needed for execution of Drive Re-initialization from BACnet.

NOTE!

This parameter is active only when 8-30 Protocol is set to [9] Adjustable Frequency Drive Option.

3.9.7 8-8* AFD Port Diagnos.

These parameters are used for monitoring the bus communication via the Adjustable Frequency Drive Port.

8-80 Bus Message Count		
Range:	Function:	
0 *	[0 - 0]	This parameter shows the number of valid messages detected on the bus.

8-81 Bus Error Count		
Range:	Function:	
0 *	[0 - 0]	This parameter shows the number of messages with faults (e.g., CRC fault), detected on the bus.

8-82 Slave Messages Rcvd		
Range:	Function:	
0 *	[0 - 0]	This parameter shows the number of valid messages addressed to the slave, sent by the Adjustable frequency drive.

8-83 Slave Error Count		
Range:	Function:	
0 *	[0 - 0]	This parameter shows the number of error messages, which could not be executed by the Adjustable frequency drive.

8-84 Slave Messages Sent		
Range:	Function:	
0 *	[0 - 0]	This parameter shows the number of messages sent from this adjustable frequency drive.

8-85 Slave Timeout Errors		
Range:	Function:	
0 *	[0 - 0]	This parameter shows the number of messages suppressed due to a timeout.

3.9.8 8-9* Bus Jog

8-90 Bus Jog 1 Speed		
Range:	Function:	
100 RPM*	[0 - par. 4-13 RPM]	Enter the jog speed. This is a fixed jog speed activated via the serial port or serial communication bus option.

8-91 Bus Jog 2 Speed		
Range:	Function:	
200 RPM* [0 - par. 4-13 RPM]	Enter the jog speed. This is a fixed jog speed activated via the serial port or serial communication bus option.	

8-94 Bus Feedback 1		
Range:	Function:	
0 * [-200 - 200]	Write a feedback to this parameter via the serial communication port or serial communication bus option. This parameter must be selected in <i>20-00 Feedback 1 Source</i> , <i>20-03 Feedback 2 Source</i> or <i>20-06 Feedback 3 Source</i> as a feedback source.	

8-95 Bus Feedback 2		
Range:	Function:	
0 * [-200 - 200]	See <i>8-94 Bus Feedback 1</i> for further details.	

8-96 Bus Feedback 3		
Range:	Function:	
0 * [-200 - 200]	See <i>8-94 Bus Feedback 1</i> for further details.	

3.10 Main Menu - Profibus - Group 9

9-15 PCD Write Configuration		
Array [10]		
Option:	Function:	
	Select the parameters to be assigned to PCD 3 to 10 of the messages. The number of available PCDs depends on the message type. The values in PCD 3 to 10 will then be written to the selected parameters as data values. Alternatively, specify a standard Profibus message in <i>9-22 Telegram Selection</i> .	
[0] *	None	
[302]	Minimum Reference	
[303]	Maximum Reference	
[341]	Ramp 1 Ramp-up Time	
[342]	Ramp 1 Ramp-down Time	
[351]	Ramp 2 Ramp-up Time	
[352]	Ramp 2 Ramp-down Time	
[380]	Jog Ramp Time	
[381]	Quick Stop Ramp Time	
[382]	Starting Ramp-up Time	
[411]	Motor Speed Low Limit [RPM]	
[413]	Motor Speed High Limit [RPM]	
[416]	Torque Limit Motor Mode	
[417]	Torque Limit Generator Mode	
[590]	Digital & Relay Bus Control	
[593]	Pulse Out #27 Bus Control	
[595]	Pulse Out #29 Bus Control	
[597]	Pulse Out #X30/6 Bus Control	
[653]	Terminal 42 Output Bus Control	
[663]	Terminal X30/8 Output Bus Control	
[890]	Bus Jog 1 Speed	
[891]	Bus Jog 2 Speed	
[894]	Bus Feedback 1	
[895]	Bus Feedback 2	
[896]	Bus Feedback 3	
[1680]	Fieldbus CTW 1	
[1682]	Fieldbus REF 1	
[2013]	Minimum Reference/Feedb.	
[2014]	Maximum Reference/Feedb.	
[2021]	Setpoint 1	
[2022]	Setpoint 2	

9-15 PCD Write Configuration		
Array [10]		
Option:	Function:	
[2023]	Setpoint 3	
[2643]	Terminal X42/7 Bus Control	
[2653]	Terminal X42/9 Bus Control	
[2663]	Terminal X42/11 Bus Control	

9-16 PCD Read Configuration		
Array [10]		
Option:	Function:	
	Select the parameters to be assigned to PCDs 3 to 10 of the messages. The number of available PCDs depends on the message type. PCDs 3 to 10 contain the actual data values of the selected parameters. For standard Profibus telegram, see <i>9-22 Telegram Selection</i> .	
[0] *	None	
[894]	Bus Feedback 1	
[895]	Bus Feedback 2	
[896]	Bus Feedback 3	
[1500]	Operating Hours	
[1501]	Running Hours	
[1502]	kWh Counter	
[1600]	Control Word	
[1601]	Reference [Unit]	
[1602]	Reference [%]	
[1603]	Status Word	
[1605]	Main Actual Value [%]	
[1609]	Custom Readout	
[1610]	Power [kW]	
[1611]	Power [hp]	
[1612]	Motor Voltage	
[1613]	Frequency	
[1614]	Motor Current	
[1615]	Frequency [%]	
[1616]	Torque [Nm]	
[1617]	Speed [RPM]	
[1618]	Motor Thermal	
[1622]	Torque [%]	
[1630]	DC Link Voltage	
[1632]	Brake Energy /s	
[1633]	Brake Energy /2 min	
[1634]	Heatsink Temp.	
[1635]	Drive Thermal	
[1638]	Logic Controller State	

9-16 PCD Read Configuration		
Array [10]		
Option:	Function:	
[1639]	Control Card Temp.	
[1650]	External Reference	
[1652]	Feedback [Unit]	
[1653]	Digi Pot Reference	
[1654]	Feedback 1 [Unit]	
[1655]	Feedback 2 [Unit]	
[1656]	Feedback 3 [Unit]	
[1660]	Digital Input	
[1661]	Terminal 53 Switch Setting	
[1662]	Analog Input 53	
[1663]	Terminal 54 Switch Setting	
[1664]	Analog Input 54	
[1665]	Analog Output 42 [mA]	
[1666]	Digital Output [bin]	
[1667]	Freq. Input #29 [Hz]	
[1668]	Freq. Input #33 [Hz]	
[1669]	Pulse Output #27 [Hz]	
[1670]	Pulse Output #29 [Hz]	
[1671]	Relay Output [bin]	
[1672]	Counter A	
[1673]	Counter B	
[1675]	Analog In X30/11	
[1676]	Analog In X30/12	
[1677]	Analog Out X30/8 [mA]	
[1684]	Comm. Option STW	
[1685]	Drive Port CTW 1	
[1690]	Alarm Word	
[1691]	Alarm Word 2	
[1692]	Warning Word	
[1693]	Warning Word 2	
[1694]	Ext. Status Word	
[1695]	Ext. Status Word 2	
[1696]	Maintenance Word	
[1830]	Analog Input X42/1	
[1831]	Analog Input X42/3	
[1832]	Analog Input X42/5	
[1833]	Analog Out X42/7 [V]	
[1834]	Analog Out X42/9 [V]	
[1835]	Analog Out X42/11 [V]	

9-18 Node Address		
Range:	Function:	
126 *	[0 - 126.]	Enter the station address in this parameter or alternatively in the hardware switch. In order to adjust the station address in <i>9-18 Node Address</i> , the hardware switch must be set to 126 or 127 (i.e. all switches set to 'on').

9-18 Node Address		
Range:	Function:	
		Otherwise this parameter will display the actual setting of the switch.

9-22 Telegram Selection		
Option:	Function:	
		Select a standard Profibus message configuration for the adjustable frequency drive, as an alternative to using the freely configurable messages in <i>9-15 PCD Write Configuration</i> and <i>9-16 PCD Read Configuration</i> .
[1]	Standard telegram 1	
[101]	PPO 1	
[102]	PPO 2	
[103]	PPO 3	
[104]	PPO 4	
[105]	PPO 5	
[106]	PPO 6	
[107]	PPO 7	
[108] *	PPO 8	
[200]	Custom telegram 1	

9-23 Parameters for Signals		
Array [1000]		
Option:	Function:	
		This parameter contains a list of signals available for selection in <i>9-15 PCD Write Configuration</i> and <i>9-16 PCD Read Configuration</i> .
[0] *	None	
[302]	Minimum Reference	
[303]	Maximum Reference	
[341]	Ramp 1 Ramp-up Time	
[342]	Ramp 1 Ramp-down Time	
[351]	Ramp 2 Ramp-up Time	
[352]	Ramp 2 Ramp-down Time	
[380]	Jog Ramp Time	
[381]	Quick Stop Ramp Time	
[382]	Starting Ramp-up Time	
[411]	Motor Speed Low Limit [RPM]	
[413]	Motor Speed High Limit [RPM]	
[416]	Torque Limit Motor Mode	
[417]	Torque Limit Generator Mode	
[590]	Digital & Relay Bus Control	
[593]	Pulse Out #27 Bus Control	

9-23 Parameters for Signals		
Array [1000]		
Option:	Function:	
[595]	Pulse Out #29 Bus Control	
[597]	Pulse Out #X30/6 Bus Control	
[653]	Terminal 42 Output Bus Control	
[663]	Terminal X30/8 Output Bus Control	
[890]	Bus Jog 1 Speed	
[891]	Bus Jog 2 Speed	
[894]	Bus Feedback 1	
[895]	Bus Feedback 2	
[896]	Bus Feedback 3	
[1500]	Operating Hours	
[1501]	Running Hours	
[1502]	kWh Counter	
[1600]	Control Word	
[1601]	Reference [Unit]	
[1602]	Reference %	
[1603]	Status Word	
[1605]	Main Actual Value [%]	
[1609]	Custom Readout	
[1610]	Power [kW]	
[1611]	Power [hp]	
[1612]	Motor voltage	
[1613]	Frequency	
[1614]	Motor Current	
[1615]	Frequency [%]	
[1616]	Torque [Nm]	
[1617]	Speed [RPM]	
[1618]	Motor Thermal	
[1622]	Torque [%]	
[1626]	Power Filtered [kW]	
[1627]	Power Filtered [hp]	
[1630]	DC Link Voltage	
[1632]	Brake Energy /s	
[1633]	Brake Energy /2 min	
[1634]	Heatsink Temp.	
[1635]	Inverter Thermal	
[1638]	SL Controller State	
[1639]	Control Card Temp.	
[1650]	External Reference	
[1652]	Feedback [Unit]	
[1653]	Digi Pot Reference	
[1654]	Feedback 1 [Unit]	
[1655]	Feedback 2 [Unit]	
[1656]	Feedback 3 [Unit]	
[1660]	Digital Input	
[1661]	Terminal 53 Switch Setting	
[1662]	Analog Input 53	
[1663]	Terminal 54 Switch Setting	
[1664]	Analog Input 54	

9-23 Parameters for Signals		
Array [1000]		
Option:	Function:	
[1665]	Analog Output 42 [mA]	
[1666]	Digital Output [bin]	
[1667]	Pulse Input #29 [Hz]	
[1668]	Pulse Input #33 [Hz]	
[1669]	Pulse Output #27 [Hz]	
[1670]	Pulse Output #29 [Hz]	
[1671]	Relay Output [bin]	
[1672]	Counter A	
[1673]	Counter B	
[1675]	Analog In X30/11	
[1676]	Analog In X30/12	
[1677]	Analog Out X30/8 [mA]	
[1680]	Fieldbus CTW 1	
[1682]	Fieldbus REF 1	
[1684]	Comm. Option Status	
[1685]	FC Port CTW 1	
[1690]	Alarm Word	
[1691]	Alarm word 2	
[1692]	Warning Word	
[1693]	Warning word 2	
[1694]	Ext. Status Word	
[1695]	Ext. Status Word 2	
[1696]	Maintenance Word	
[1830]	Analog Input X42/1	
[1831]	Analog Input X42/3	
[1832]	Analog Input X42/5	
[1833]	Analog Out X42/7 [V]	
[1834]	Analog Out X42/9 [V]	
[1835]	Analog Out X42/11 [V]	
[1850]	Sensorless Readout [unit]	
[2013]	Minimum Reference/Feedb.	
[2014]	Maximum Reference/Feedb.	
[2021]	Setpoint 1	
[2022]	Setpoint 2	
[2023]	Setpoint 3	
[2643]	Terminal X42/7 Bus Control	
[2653]	Terminal X42/9 Bus Control	
[2663]	Terminal X42/11 Bus Control	

9-27 Parameter Edit		
Option:	Function:	
		Parameters can be edited via Profibus, the standard RS485 interface, or the LCP.
[0]	Disabled	Disables editing via Profibus.
[1] *	Enabled	Enables editing via Profibus.

9-28 Process Control		
Option:	Function:	
		Process control (setting of the control word, speed reference, and process data) is possible via either Profibus or standard serial communication bus but not both simultaneously. Local control is always possible via the LCP. Control via process control is possible via either terminals or serial communication bus depending on the settings in 8-50 <i>Coasting Select</i> to 8-56 <i>Preset Reference Select</i> .
[0]	Disable	Disables process control via Profibus, and enables process control via standard serial communication bus or Profibus Master class 2.
[1] *	Enable cyclic master	Enables process control via Profibus Master Class 1, and disables process control via standard serial communication bus or Profibus Master class 2.

9-53 Profibus Warning Word		
Range:	Function:	
0 * [0 - 65535]	This parameter displays Profibus communication warnings. Please refer to the <i>Profibus Instruction Manual</i> for further information.	

Read only

Bit:	Meaning:
0	Connection with DP master is not ok
1	Not used
2	FDLNDL (Serial Communication Bus Data link Layer) is not ok
3	Clear data command received
4	Actual value is not updated
5	Baudrate search
6	PROFIBUS ASIC is not transmitting
7	Initialization of PROFIBUS is not ok
8	Adjustable frequency drive is tripped
9	Internal CAN error
10	Wrong configuration data from PLC
11	Wrong ID sent by PLC
12	Internal error occurred
13	Not configured
14	Timeout active
15	Warning 34 active

Table 3.15

9-63 Actual Baud Rate		
Option:	Function:	
		This parameter displays the actual Profibus baud rate. The Profibus Master automatically sets the baud rate.
[0]	9.6 kbit/s	
[1]	19.2 kbit/s	
[2]	93.75 kbit/s	
[3]	187.5 kbit/s	
[4]	500 kbit/s	
[6]	1500 kbit/s	
[7]	3000 kbit/s	
[8]	6000 kbit/s	
[9]	12000 kbit/s	
[10]	31.25 kbit/s	
[11]	45.45 kbit/s	
[255] *	No baud rate found	

9-65 Profile Number		
Range:	Function:	
0 * [0 - 0]	This parameter contains the profile identification. Byte 1 contains the profile number and byte 2 the version number of the profile.	

NOTE!

This parameter is not visible via LCP.

9-70 Programming Set-up		
Option:	Function:	
		Select the set-up to be edited.
[0]	Factory setup	Uses default data. This option can be used as a data source to return the other set-ups to a known state.
[1]	Set-up 1	Edits Set-up 1.
[2]	Set-up 2	Edits Set-up 2.
[3]	Set-up 3	Edits Set-up 3.
[4]	Set-up 4	Edits Set-up 4.
[9] *	Active Set-up	Follows the active set-up selected in 0-10 <i>Active Set-up</i> .

 This parameter is unique to LCP and serial communication busses. See also 0-11 *Programming Set-up*.

9-71 Profibus Save Data Values		
Option:	Function:	
		Parameter values changed via Profibus are not automatically stored in non-volatile memory. Use this parameter to activate a function that stores parameter values in the EEPROM non-volatile memory, so changed parameter values will be retained at power-down.
[0] *	Off	Deactivates the non-volatile storage function.
[1]	Store edit setup	Stores all parameter values for all set-ups in the non-volatile memory. The selection returns to <i>Off</i> [0] when all parameter values have been stored.
[2]	Store all setups	Stores all parameter values for all set-ups in the non-volatile memory. The selection returns to <i>Off</i> [0] when all parameter values have been stored.

9-72 ProfibusDriveReset		
Option:	Function:	
[0] *	No action	
[1]	Power-on reset	Resets Adjustable frequency drive upon power-up, as for power-cycle.
[3]	Comm option reset	Resets the Profibus option only, useful after changing certain settings in parameter group 9-**, e.g., 9-18 <i>Node Address</i> . When reset, the Adjustable frequency drive disappears from the serial communication bus, which may cause a communication error from the master.

9-80 Defined Parameters (1)		
Array [116] No LCP access Read only		
Range:		Function:
0 *	[0 - 9999]	This parameter displays a list of all the defined Adjustable frequency drive parameters available for Profibus.

9-81 Defined Parameters (2)		
Array [116] No LCP access Read only		
Range:		Function:
0 *	[0 - 9999]	This parameter displays a list of all the defined Adjustable frequency drive parameters available for Profibus.

9-82 Defined Parameters (3)		
Array [116] No LCP access Read only		
Range:		Function:
0 *	[0 - 9999]	This parameter displays a list of all the defined Adjustable frequency drive parameters available for Profibus.

9-83 Defined Parameters (4)		
Array [116] No LCP access Read only		
Range:		Function:
0 *	[0 - 9999]	This parameter displays a list of all the defined Adjustable frequency drive parameters available for Profibus.

9-90 Changed Parameters (1)		
Array [116] No LCP access Read only		
Range:		Function:
0 *	[0 - 9999]	This parameter displays a list of all the Adjustable frequency drive parameters deviating from default setting.

9-91 Changed Parameters (2)		
Array [116] No LCP access Read only		
Range:		Function:
0 *	[0 - 9999]	This parameter displays a list of all the Adjustable frequency drive parameters deviating from default setting.

9-92 Changed Parameters (3)		
Array [116] No LCP access Read only		
Range:		Function:
0 *	[0 - 9999]	This parameter displays a list of all the Adjustable frequency drive parameters deviating from default setting.

3

9-94 Changed parameters (5)		
Array [116]		
No LCP Address		
Read only		
Range:		Function:
0 *	[0 - 9999]	This parameter displays a list of all the Adjustable frequency drive parameters deviating from default setting.

3.11 Main Menu - CAN Fieldbus (Serial Communication bus) - Group 10

3.11.1 10-** DeviceNet and CAN serial communications bus

3.11.2 10-0* Common Settings

10-00 CAN Protocol		
Option:	Function:	
[1] *	DeviceNet	View the active CAN protocol.

NOTE!

The parameter options depend on installed option.

10-01 Baud Rate Select		
Option:	Function:	
		Select the serial communication bus transmission speed. The selection must correspond to the transmission speed of the master and the other serial communication bus nodes.
[16]	10 Kbps	
[17]	20 Kbps	
[18]	50 Kbps	
[19]	100 Kbps	
[20] *	125 Kbps	
[21]	250 Kbps	
[22]	500 Kbps	
[23]	800 Kbps	
[24]	1000 Kbps	

10-02 MAC ID		
Range:	Function:	
Size related*	[0 - 63.]	

10-05 Readout Transmit Error Counter		
Range:	Function:	
0 *	[0 - 255]	View the number of CAN control transmission errors since the last power-up.

10-06 Readout Receive Error Counter		
Range:	Function:	
0 *	[0 - 255]	View the number of CAN control receipt errors since the last power-up.

10-07 Readout Bus Off Counter		
Range:	Function:	
0 *	[0 - 255]	View the number of Bus Off events since the last power-up.

3.11.3 10-1* DeviceNet

10-10 Process Data Type Selection		
Option:	Function:	
		Select the Instance (message) for data transmission. The instances available are dependent upon the setting of <i>8-10 Control Profile</i> . When <i>8-10 Control Profile</i> is set to [0] <i>FC profile</i> , <i>10-10 Process Data Type Selection</i> options [0] and [1] are available. When <i>8-10 Control Profile</i> is set to [5] <i>ODVA</i> , <i>10-10 Process Data Type Selection</i> options [2] and [3] are available. Instances 100/150 and 101/151 are Danfoss-specific. Instances 20/70 and 21/71 are ODVA-specific AC Drive profiles. For guidelines in message selection, please refer to the <i>DeviceNet Instruction Manual</i> . Note that a change to this parameter will be executed immediately.
[0] *	INSTANCE 100/150	
[1]	INSTANCE 101/151	
[2]	INSTANCE 20/70	
[3]	INSTANCE 21/71	

10-11 Process Data Config Write		
Option:	Function:	
		Select the process write data for I/O assembly instances 101/151. Elements [2] and [3] of this array can be selected. Elements [0] and [1] of the array are fixed.
[0]	None	
[302]	Minimum Reference	
[303]	Maximum Reference	
[341]	Ramp 1 Ramp-up Time	
[342]	Ramp 1 Ramp-down Time	
[351]	Ramp 2 Ramp-up Time	
[352]	Ramp 2 Ramp-down Time	
[380]	Jog Ramp Time	
[381]	Quick Stop Ramp Time	
[382]	Starting Ramp-up Time	
[411]	Motor Speed Low Limit [RPM]	
[413]	Motor Speed High Limit [RPM]	
[416]	Torque Limit Motor Mode	
[417]	Torque Limit Generator Mode	
[590]	Digital & Relay Bus Control	
[593]	Pulse Out #27 Bus Control	
[595]	Pulse Out #29 Bus Control	
[597]	Pulse Out #X30/6 Bus Control	
[653]	Terminal 42 Output Bus Control	
[663]	Terminal X30/8 Output Bus Control	
[890]	Bus Jog 1 Speed	
[891]	Bus Jog 2 Speed	
[894]	Bus Feedback 1	
[895]	Bus Feedback 2	
[896]	Bus Feedback 3	
[1680]	Fieldbus CTW 1	
[1682]	Fieldbus REF 1	
[2013]	Minimum Reference/Feedb.	
[2014]	Maximum Reference/Feedb.	
[2021]	Setpoint 1	
[2022]	Setpoint 2	
[2023]	Setpoint 3	
[2643]	Terminal X42/7 Bus Control	
[2653]	Terminal X42/9 Bus Control	
[2663]	Terminal X42/11 Bus Control	

10-12 Process Data Config Read		
Option:	Function:	
		Select the process read data for I/O assembly instances 101/151. Elements [2] and [3]

10-12 Process Data Config Read		
Option:	Function:	
		of this array can be selected. Elements [0] and [1] of the array are fixed.
[0] *	None	
[894]	Bus Feedback 1	
[895]	Bus Feedback 2	
[896]	Bus Feedback 3	
[1500]	Operating Hours	
[1501]	Running Hours	
[1502]	kWh Counter	
[1600]	Control Word	
[1601]	Reference [Unit]	
[1602]	Reference %	
[1603]	Status Word	
[1605]	Main Actual Value [%]	
[1609]	Custom Readout	
[1610]	Power [kW]	
[1611]	Power [hp]	
[1612]	Motor voltage	
[1613]	Frequency	
[1614]	Motor Current	
[1615]	Frequency [%]	
[1616]	Torque [Nm]	
[1617]	Speed [RPM]	
[1618]	Motor Thermal	
[1622]	Torque [%]	
[1626]	Power Filtered [kW]	
[1627]	Power Filtered [hp]	
[1630]	DC Link Voltage	
[1632]	Brake Energy /s	
[1633]	Brake Energy /2 min	
[1634]	Heatsink Temp.	
[1635]	Inverter Thermal	
[1638]	SL Controller State	
[1639]	Control Card Temp.	
[1650]	External Reference	
[1652]	Feedback [Unit]	
[1653]	Digi Pot Reference	
[1654]	Feedback 1 [Unit]	
[1655]	Feedback 2 [Unit]	
[1656]	Feedback 3 [Unit]	
[1660]	Digital Input	
[1661]	Terminal 53 Switch Setting	
[1662]	Analog Input 53	
[1663]	Terminal 54 Switch Setting	
[1664]	Analog Input 54	
[1665]	Analog Output 42 [mA]	
[1666]	Digital Output [bin]	
[1667]	Pulse Input #29 [Hz]	

10-12 Process Data Config Read		
Option:	Function:	
[1668]	Pulse Input #33 [Hz]	
[1669]	Pulse Output #27 [Hz]	
[1670]	Pulse Output #29 [Hz]	
[1671]	Relay Output [bin]	
[1672]	Counter A	
[1673]	Counter B	
[1675]	Analog In X30/11	
[1676]	Analog In X30/12	
[1677]	Analog Out X30/8 [mA]	
[1684]	Comm. Option Status	
[1685]	FC Port CTW 1	
[1690]	Alarm Word	
[1691]	Alarm word 2	
[1692]	Warning Word	
[1693]	Warning word 2	
[1694]	Ext. Status Word	
[1695]	Ext. Status Word 2	
[1696]	Maintenance Word	
[1830]	Analog Input X42/1	
[1831]	Analog Input X42/3	
[1832]	Analog Input X42/5	
[1833]	Analog Out X42/7 [V]	
[1834]	Analog Out X42/9 [V]	
[1835]	Analog Out X42/11 [V]	
[1850]	Sensorless Readout [unit]	

10-13 Warning Parameter		
Range:	Function:	
0 *	[0 - 65535]	View a DeviceNet-specific warning word. One bit is assigned to every warning. Refer to the DeviceNet Instruction Manual (MG.33.DX.YY) for further information.

Bit:	Meaning:
0	Bus not active
1	Explicit connection timeout
2	I/O connection
3	Retry limit reached
4	Actual is not updated
5	CAN bus off
6	I/O send error
7	Initialization error
8	No bus supply
9	Bus off
10	Error passive
11	Error warning
12	Duplicate MAC ID Error
13	RX queue overrun
14	TX queue overrun
15	CAN overrun

Table 3.16

10-14 Net Reference		
Read only from LCP		
Option:	Function:	
		Select the reference source in instance 21/71 and 20/70.
[0] *	Off	Enables reference via analog/digital inputs.
[1]	On	Enables reference via the serial communication bus.

10-15 Net Control		
Read only from LCP		
Option:	Function:	
		Select the control source in Instance 21/71 and 20/70.
[0] *	Off	Enables control via analog/digital inputs.
[1]	On	Enable control via the serial communication bus.

3.11.4 10-2* COS Filters

10-20 COS Filter 1		
Range:	Function:	
0 *	[0 - 65535]	Enter the value for COS Filter 1 to set up the filter mask for the status word. When operating in COS (Change-Of-State), this function filters out bits in the status word that should not be sent if they change.

10-21 COS Filter 2		
Range:	Function:	
0 * [0 - 65535]	Enter the value for COS Filter 2, to set up the filter mask for the Main Actual Value. When operating in COS (Change-Of-State), this function filters out bits in the Main Actual Value that should not be sent if they change.	

10-22 COS Filter 3		
Range:	Function:	
0 * [0 - 65535]	Enter the value for COS Filter 3, to set up the filter mask for PCD 3. When operating in COS (Change-Of-State), this function filters out bits in PCD 3 that should not be sent if they change.	

10-23 COS Filter 4		
Range:	Function:	
0 * [0 - 65535]	Enter the value for COS Filter 4 to set up the filter mask for PCD 4. When operating in COS (Change-Of-State), this function filters out bits in PCD 4 that should not be sent if they change.	

3.11.5 10-3* Parameter Access

Parameter group providing access to indexed parameters and defining programming set-up.

10-31 Store Data Values		
Option:	Function:	
	Parameter values changed via DeviceNet are not automatically stored in non-volatile memory. Use this parameter to activate a function that stores parameter values in the EEPROM non-volatile memory, so that changed parameter values will be retained at power-down.	
[0]	Off	Deactivates the non-volatile storage function.
[1]	Store edit setup	Stores all parameter values from the active set-up in the non-volatile memory. The selection returns to Off [0] when all values have been stored.
[2]	Store all setups	Stores all parameter values for all set-ups in the non-volatile memory. The selection returns to Off [0] when all parameter values have been stored.

10-33 Store Always		
Option:	Function:	
[0]	Off	Deactivates non-volatile storage of data.
[1]	On	Stores parameter data received via DeviceNet in EEPROM non-volatile memory as default.

3.12 Main Menu - LonWorks - Group 11

Parameter group for all LonWorks specific parameters.
Parameters related to LonWorks ID.

11-00 Neuron ID		
Range:	Function:	
0 *	[0 - 0]	View the Neuron chip's unique Neuron ID number.

11-10 Drive Profile		
Option:	Function:	
		This parameter allows selecting between LONMARK Functional Profiles.
[0] *	VSD profile	The Danfoss Profile and the Node Object are common for all profiles.
[1]	Pump controller	

11-15 LON Warning Word		
Range:	Function:	
0 *	[0 - 65535]	This parameter contains the LON specific warnings.

Bit	Status
0	Internal fault
1	Internal fault
2	Internal fault
3	Internal fault
4	Internal fault
5	Reserved
6	Reserved
7	Reserved
8	Reserved
9	Changeable types
10	Initialization error
11	Internal communication error
12	Software revision mismatch
13	Bus not active
14	Option not present
15	LON input (nvi/nci) exceeds limits

Table 3.17

11-17 XIF Revision		
Range:	Function:	
0 *	[0 - 0]	This parameter contains the version of the external interface file on the Neuron C chip on the LON option.

11-18 LonWorks Revision		
Range:	Function:	
0 *	[0 - 0]	This parameter contains the software version of the application program on the Neuron C chip on the LON option.

11-21 Store Data Values		
Option:	Function:	
		This parameter is used to activate storing of data in non-volatile memory.
[0] *	Off	Store function is inactive.
[2]	Store all setups	Stores all parameter values in the E ² PROM. The value returns to <i>Off</i> when all parameter values have been stored.

3.13 Main Menu - Smart Logic - Group 13

3.13.1 13-** Prog. Features Prog. Features

Smart Logic Control (SLC) is essentially a sequence of user-defined actions (see *13-52 SL Controller Action [x]*) executed by the SLC when the associated user-defined event (see *13-51 SL Controller Event [x]*) is evaluated as TRUE by the SLC. Events and actions are each numbered and linked together in pairs. This means that when event [0] is fulfilled (attains the value TRUE), action [0] is executed. After this, the conditions of event [1] will be evaluated and if evaluated TRUE, action [1] will be executed and so on. Only one event will be evaluated at any time. If an event is evaluated as FALSE, nothing happens (in the SLC) during the current scan interval and no other events will be evaluated. This means that when the SLC starts, it evaluates event [0] (and only event [0]) each scan interval. Only when event [0] is evaluated TRUE, will the SLC execute action [0] and start evaluating event [1]. It is possible to program from 1 to 20 events and actions. When the last event/action has been executed, the sequence starts over again from event [0]/action [0]. The figure shows an example with three event/actions:

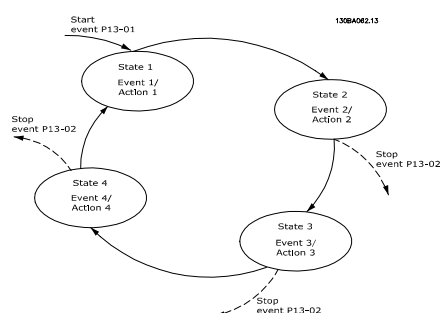

Figure 3.31

Starting and stopping the SLC:

Starting and stopping the SLC can be done by selecting On [1] or Off [0] in *13-00 SL Controller Mode*. The SLC always starts in state 0 (where it evaluates event [0]). The SLC starts when the Start Event (defined in *13-01 Start Event*) is evaluated as TRUE (provided that On [1] is selected in *13-00 SL Controller Mode*). The SLC stops when the Stop Event (*13-02 Stop Event*) is TRUE. *13-03 Reset SLC* resets all SLC parameters and starts programming from scratch.

3.13.2 13-0* SLC Settings

Use the SLC settings to activate, deactivate and reset the Smart Logic Control sequence. The logic functions and comparators are always running in the background, which opens for separate control of digital inputs and outputs.

13-00 SL Controller Mode		
Option:	Function:	
[0]	Off	Disables the Smart Logic Controller.
[1]	On	Enables the Smart Logic Controller.

13-01 Start Event		
Option:	Function:	
		Select the Boolean (TRUE or FALSE) input to activate smart logic control.
[0] *	FALSE	Enters the fixed value of FALSE in the logic rule.
[1]	TRUE	Enters the fixed value TRUE in the logic rule.
[2]	Running	See parameter group 5-3* for further description.
[3]	In range	See parameter group 5-3* for further description.
[4]	On reference	See parameter group 5-3* for further description.
[5]	Torque limit	See parameter group 5-3* for further description.
[6]	Current limit	See parameter group 5-3* for further description.
[7]	Out of current range	See parameter group 5-3* for further description.
[8]	Below I low	See parameter group 5-3* for further description.
[9]	Above I high	See parameter group 5-3* for further description.
[10]	Out of speed range	
[11]	Below speed low	See parameter group 5-3* for further description.
[12]	Above speed high	See parameter group 5-3* for further description.
[13]	Out of feedb. range	
[14]	Below feedb. low	
[15]	Above feedb. high	

13-01 Start Event		
Option:	Function:	
[16]	Thermal warning	See parameter group 5-3* for further description.
[17]	Mains out of range	See parameter group 5-3* for further description.
[18]	Reverse	See parameter group 5-3* for further description.
[19]	Warning	See parameter group 5-3* for further description.
[20]	Alarm (trip)	See parameter group 5-3* for further description.
[21]	Alarm (trip lock)	See parameter group 5-3* for further description.
[22]	Comparator 0	Use the result of comparator 0 in the logic rule.
[23]	Comparator 1	Use the result of comparator 1 in the logic rule.
[24]	Comparator 2	Use the result of comparator 2 in the logic rule.
[25]	Comparator 3	Use the result of comparator 3 in the logic rule.
[26]	Logic rule 0	Use the result of logic rule 0 in the logic rule.
[27]	Logic rule 1	Use the result of logic rule 1 in the logic rule.
[28]	Logic rule 2	Use the result of logic rule 2 in the logic rule.
[29]	Logic rule 3	Use the result of logic rule 3 in the logic rule.
[33]	Digital input DI18	Use the value of DI18 in the logic rule (High = TRUE).
[34]	Digital input DI19	Use the value of DI19 in the logic rule (High = TRUE).
[35]	Digital input DI27	Use the value of DI27 in the logic rule (High = TRUE).
[36]	Digital input DI29	Use the value of DI29 in the logic rule (High = TRUE).
[37]	Digital input DI32	Use the value of DI32 in the logic rule (High = TRUE).
[38]	Digital input DI33	Use the value of DI33 in the logic rule (High = TRUE).
[39]	Start command	This event is TRUE if the Adjustable frequency drive is started by any means (either via digital input, serial communication bus or other).

13-01 Start Event		
Option:	Function:	
[40]	Drive stopped	This event is TRUE if the Adjustable frequency drive is stopped or coasted by any means (either via digital input, serial communication bus or other).
[41]	Reset Trip	This event is TRUE if the Adjustable frequency drive is tripped (but not trip-locked) and the reset button is pressed.
[42]	Auto Reset Trip	This event is TRUE if the Adjustable frequency drive is tripped (but not trip-locked) and an automatic reset is issued.
[43]	OK Key	This event is TRUE if the OK key on the LCP is pressed.
[44]	Reset Key	This event is TRUE if the reset key on the LCP is pressed.
[45]	Left Key	This event is TRUE if the left key on the LCP is pressed.
[46]	Right Key	This event is TRUE if the right key on the LCP is pressed.
[47]	Up Key	This event is TRUE if the up key on the LCP is pressed.
[48]	Down Key	This event is TRUE if the down key on the LCP is pressed.
[50]	Comparator 4	Use the result of comparator 4 in the logic rule.
[51]	Comparator 5	Use the result of comparator 5 in the logic rule.
[60]	Logic rule 4	Use the result of logic rule 4 in the logic rule.
[61]	Logic rule 5	Use the result of logic rule 5 in the logic rule.
[76]	Digital Input x30 2	
[77]	Digital Input x30 3	
[78]	Digital Input x30 4	
[90]	ECB Drive Mode	
[91]	ECB Bypass Mode	
[92]	ECB Test Mode	
[100]	Fire Mode	

13-02 Stop Event		
Option:	Function:	
		Select the Boolean (TRUE or FALSE) input to deactivate Smart Logic Control.

13-02 Stop Event		
Option:	Function:	
[0] *	FALSE	Enters the fixed value of FALSE in the logic rule.
[1]	TRUE	Enters the fixed value TRUE in the logic rule.
[2]	Running	See parameter group 5-3* for further description.
[3]	In range	See parameter group 5-3* for further description.
[4]	On reference	See parameter group 5-3* for further description.
[5]	Torque limit	See parameter group 5-3* for further description.
[6]	Current limit	See parameter group 5-3* for further description.
[7]	Out of current range	See parameter group 5-3* for further description.
[8]	Below I low	See parameter group 5-3* for further description.
[9]	Above I high	See parameter group 5-3* for further description.
[10]	Out of speed range	
[11]	Below speed low	See parameter group 5-3* for further description.
[12]	Above speed high	See parameter group 5-3* for further description.
[13]	Out of feedb. range	See parameter group 5-3* for further description.
[14]	Below feedb. low	See parameter group 5-3* for further description.
[15]	Above feedb. high	See parameter group 5-3* for further description.
[16]	Thermal warning	See parameter group 5-3* for further description.
[17]	Mains out of range	See parameter group 5-3* for further description.
[18]	Reverse	See parameter group 5-3* for further description.
[19]	Warning	See parameter group 5-3* for further description.
[20]	Alarm (trip)	See parameter group 5-3* for further description.
[21]	Alarm (trip lock)	See parameter group 5-3* for further description.

13-02 Stop Event		
Option:	Function:	
[22]	Comparator 0	Use the result of comparator 0 in the logic rule.
[23]	Comparator 1	Use the result of comparator 1 in the logic rule.
[24]	Comparator 2	Use the result of comparator 2 in the logic rule.
[25]	Comparator 3	Use the result of comparator 3 in the logic rule.
[26]	Logic rule 0	Use the result of logic rule 0 in the logic rule.
[27]	Logic rule 1	Use the result of logic rule 1 in the logic rule.
[28]	Logic rule 2	Use the result of logic rule 2 in the logic rule.
[29]	Logic rule 3	Use the result of logic rule 3 in the logic rule.
[30]	SL Timeout 0	Use the result of timer 0 in the logic rule.
[31]	SL Timeout 1	Use the result of timer 1 in the logic rule.
[32]	SL Timeout 2	Use the result of timer 2 in the logic rule.
[33]	Digital input DI18	Use the value of DI18 in the logic rule (High = TRUE).
[34]	Digital input DI19	Use the value of DI19 in the logic rule (High = TRUE).
[35]	Digital input DI27	Use the value of DI27 in the logic rule (High = TRUE).
[36]	Digital input DI29	Use the value of DI29 in the logic rule (High = TRUE).
[37]	Digital input DI32	Use the value of DI32 in the logic rule (High = TRUE).
[38]	Digital input DI33	Use the value of DI33 in the logic rule (High = TRUE).
[39]	Start command	This event is TRUE if the Adjustable frequency drive is started by any means (either via digital input, serial communication bus or other).
[40]	Drive stopped	This event is TRUE if the Adjustable frequency drive is stopped or coasted by any means (either via digital input, serial communication bus or other).
[41]	Reset Trip	This event is TRUE if the Adjustable frequency drive is tripped (but not

13-02 Stop Event		
Option:	Function:	
		trip-locked) and the reset button is pressed.
[42]	Auto Reset Trip	This event is TRUE if the Adjustable frequency drive is tripped (but not trip-locked) and an automatic reset is issued.
[43]	OK Key	This event is TRUE if the OK key on the LCP is pressed.
[44]	Reset Key	This event is TRUE if the reset key on the LCP is pressed.
[45]	Left Key	This event is TRUE if the left key on the LCP is pressed.
[46]	Right Key	This event is TRUE if the right key on the LCP is pressed.
[47]	Up Key	This event is TRUE if the up key on the LCP is pressed.
[48]	Down Key	This event is TRUE if the down key on the LCP is pressed.
[50]	Comparator 4	Use the result of comparator 4 in the logic rule.
[51]	Comparator 5	Use the result of comparator 5 in the logic rule.
[60]	Logic rule 4	Use the result of logic rule 4 in the logic rule.
[61]	Logic rule 5	Use the result of logic rule 5 in the logic rule.
[70]	SL Timeout 3	Use the result of timer 3 in the logic rule.
[71]	SL Timeout 4	Use the result of timer 4 in the logic rule.
[72]	SL Timeout 5	Use the result of timer 5 in the logic rule.
[73]	SL Timeout 6	Use the result of timer 6 in the logic rule.
[74]	SL Timeout 7	Use the result of timer 7 in the logic rule.
[76]	Digital Input x30 2	
[77]	Digital Input x30 3	
[78]	Digital Input x30 4	
[80]	No Flow	
[81]	Dry Pump	
[82]	End of Curve	
[83]	Broken Belt	
[90]	ECB Drive Mode	
[91]	ECB Bypass Mode	

13-02 Stop Event		
Option:	Function:	
[92]	ECB Test Mode	
[100]	Fire Mode	

13-03 Reset SLC		
Option:	Function:	
[0] *	Do not reset SLC	Retains programmed settings in all group 13 parameters (13-**).
[1]	Reset SLC	Resets all group 13 parameters (13-**) to default settings.

3.13.3 13-1* Comparators

Comparators are used for comparing continuous variables (i.e., output frequency, output current, analog input, etc.) to fixed preset values.

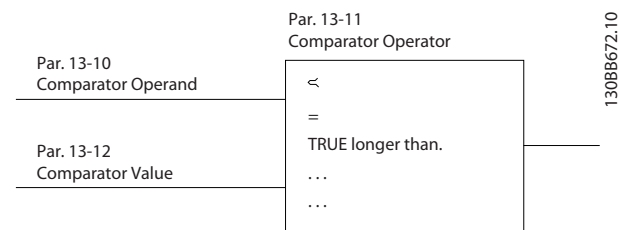

Figure 3.32

In addition, there are digital values that will be compared to fixed time values. See explanation in *13-10 Comparator Operand*. Comparators are evaluated once in each scan interval. Use the result (TRUE or FALSE) directly. All parameters in this parameter group are array parameters with index 0 to 5. Select index 0 to program Comparator 0, select index 1 to program Comparator 1, etc.

13-10 Comparator Operand		
Array [4]		
Option:	Function:	
		Select the variable to be monitored by the comparator.
[0] *	DISABLED	
[1]	Reference	
[2]	Feedback	
[3]	Motor speed	
[4]	Motor current	
[5]	Motor torque	
[6]	Motor power	
[7]	Motor voltage	
[8]	DC-link voltage	
[9]	Motor thermal	

13-10 Comparator Operand		
Array [4]		
Option:	Function:	
[10]	VLT temp.	
[11]	Heat sink temp.	
[12]	Analog input AI53	
[13]	Analog input AI54	
[14]	Analog input AIFB10	
[15]	Analog input AIS24V	
[17]	Analog input AICCT	
[18]	Pulse input FI29	
[19]	Pulse input FI33	
[20]	Alarm number	
[21]	Warning number	
[22]	Analog input x30 11	
[23]	Analog input x30 12	
[30]	Counter A	
[31]	Counter B	
[40]	Analog input x42/1	
[41]	Analog input x42/3	
[42]	Analog input x42/5	
[50]	FALSE	
[51]	TRUE	
[52]	Control ready	
[53]	Drive ready	
[54]	Running	
[55]	Reversing	
[56]	In range	
[60]	On reference	
[61]	Below reference, low	
[62]	Above ref, high	
[65]	Torque limit	
[66]	Current limit	
[67]	Out of current range	
[68]	Below I low	
[69]	Above I high	
[70]	Out of speed range	
[71]	Below speed low	
[72]	Above speed high	
[75]	Out of feedb. range	
[76]	Below feedb. low	
[77]	Above feedb. high	
[80]	Thermal warning	
[82]	Line pwr out of range	
[85]	Warning	
[86]	Alarm (trip)	
[87]	Alarm (trip lock)	
[90]	Bus OK	
[91]	Torque limit & stop	
[92]	Brake fault (IGBT)	
[93]	Mech. brake control	

13-10 Comparator Operand		
Array [4]		
Option:	Function:	
[94]	Safe stop active	
[100]	Comparator 0	
[101]	Comparator 1	
[102]	Comparator 2	
[103]	Comparator 3	
[104]	Comparator 4	
[105]	Comparator 5	
[110]	Logic rule 0	
[111]	Logic rule 1	
[112]	Logic rule 2	
[113]	Logic rule 3	
[114]	Logic rule 4	
[115]	Logic rule 5	
[120]	SL Timeout 0	
[121]	SL Timeout 1	
[122]	SL Timeout 2	
[123]	SL Timeout 3	
[124]	SL Timeout 4	
[125]	SL Timeout 5	
[126]	SL Timeout 6	
[127]	SL Timeout 7	
[130]	Digital input DI18	
[131]	Digital input DI19	
[132]	Digital input DI27	
[133]	Digital input DI29	
[134]	Digital input DI32	
[135]	Digital input DI33	
[150]	SL digital output A	
[151]	SL digital output B	
[152]	SL digital output C	
[153]	SL digital output D	
[154]	SL digital output E	
[155]	SL digital output F	
[160]	Relay 1	
[161]	Relay 2	
[180]	Local ref. active	
[181]	Remote ref. active	
[182]	Start command	
[183]	Drive stopped	
[185]	Drive in hand mode	
[186]	Drive in auto mode	
[187]	Start command given	
[190]	Digital input x30 2	
[191]	Digital input x30 3	
[192]	Digital input x30 4	

13-11 Comparator Operator		
Array [6]		
Option:	Function:	
[0] * <	Select < [0] for the result of the evaluation to be TRUE, when the variable selected in 13-10 Comparator Operand is smaller than the fixed value in 13-12 Comparator Value. The result will be FALSE, if the variable selected in 13-10 Comparator Operand is greater than the fixed value in 13-12 Comparator Value.	
[1] = (equal)	Select ≈ [1] for the result of the evaluation to be TRUE, when the variable selected in 13-10 Comparator Operand is approximately equal to the fixed value in 13-12 Comparator Value.	
[2] >	Select > [2] for the inverse logic of option < [0].	
[5] TRUE longer than..		
[6] FALSE longer than..		
[7] TRUE shorter than..		
[8] FALSE shorter than..		

13-12 Comparator Value		
Array [6]		
Range:	Function:	
Size related* [-100000.000 - 100000.000]	Enter the 'trigger level' for the variable that is monitored by this comparator. This is an array parameter containing comparator values 0 to 5.	

3.13.4 13-2* Timers

Use the result (TRUE or FALSE) from *timers* directly to define an *event* (see 13-51 SL Controller Event), or as Boolean input in a *logic rule* (see 13-40 Logic Rule Boolean 1, 13-42 Logic Rule Boolean 2 or 13-44 Logic Rule Boolean 3). A timer is only FALSE when started by an action (i.e., Start timer 1 [29]) until the timer value entered in this parameter is elapsed. Then it becomes TRUE again. All parameters in this parameter group are array parameters with index 0 to 2. Select index 0 to program Timer 0, select index 1 to program Timer 1, and so on.

13-20 SL Controller Timer		
Array [3]		
Range:	Function:	
Size related*	[0.000 - 0.000]	

3.13.5 13-4* Logic Rules

Combine up to three boolean inputs (TRUE / FALSE inputs) from timers, comparators, digital inputs, status bits and events using the logical operators AND, OR, and NOT. Select Boolean inputs for the calculation in 13-40 Logic Rule Boolean 1, 13-42 Logic Rule Boolean 2 and 13-44 Logic Rule Boolean 3. Define the operators used to logically combine the selected inputs in 13-41 Logic Rule Operator 1 and 13-43 Logic Rule Operator 2.

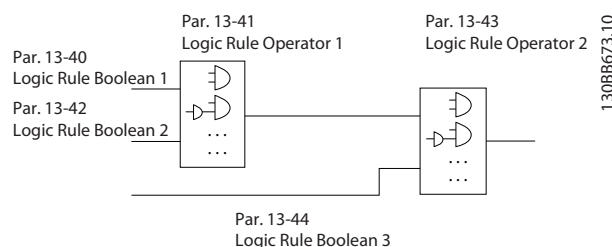

Figure 3.33

Priority of calculation

The results of 13-40 Logic Rule Boolean 1, 13-41 Logic Rule Operator 1 and 13-42 Logic Rule Boolean 2 are calculated first. The outcome (TRUE / FALSE) of this calculation is combined with the settings of 13-43 Logic Rule Operator 2 and 13-44 Logic Rule Boolean 3, yielding the final result (TRUE / FALSE) of the logic rule.

13-40 Logic Rule Boolean 1		
Array [6]		
Option:	Function:	
[0] * FALSE	Enters the fixed value of FALSE in the logic rule.	
[1] TRUE	Enters the fixed value TRUE in the logic rule.	
[2] Running	See parameter group 5-3* for further description.	
[3] In range	See parameter group 5-3* for further description.	
[4] On reference	See parameter group 5-3* for further description.	
[5] Torque limit	See parameter group 5-3* for further description.	

13-40 Logic Rule Boolean 1		
Array [6]		
Option:	Function:	
[6]	Current limit	See parameter group 5-3* for further description.
[7]	Out of current range	See parameter group 5-3* for further description.
[8]	Below I low	See parameter group 5-3* for further description.
[9]	Above I high	See parameter group 5-3* for further description.
[10]	Out of speed range	
[11]	Below speed low	See parameter group 5-3* for further description.
[12]	Above speed high	See parameter group 5-3* for further description.
[13]	Out of feedb. range	See parameter group 5-3* for further description.
[14]	Below feedb. low	See parameter group 5-3* for further description.
[15]	Above feedb. high	See parameter group 5-3* for further description.
[16]	Thermal warning	See parameter group 5-3* for further description.
[17]	Mains out of range	See parameter group for further description.
[18]	Reverse	See parameter group 5-3* for further description.
[19]	Warning	See parameter group 5-3* for further description.
[20]	Alarm (trip)	See parameter group 5-3* for further description.
[21]	Alarm (trip lock)	See parameter group 5-3* for further description.
[22]	Comparator 0	Use the result of comparator 0 in the logic rule.
[23]	Comparator 1	Use the result of comparator 1 in the logic rule.
[24]	Comparator 2	Use the result of comparator 2 in the logic rule.
[25]	Comparator 3	Use the result of comparator 3 in the logic rule.
[26]	Logic rule 0	Use the result of logic rule 0 in the logic rule.

13-40 Logic Rule Boolean 1		
Array [6]		
Option:	Function:	
[27]	Logic rule 1	Use the result of logic rule 1 in the logic rule.
[28]	Logic rule 2	Use the result of logic rule 2 in the logic rule.
[29]	Logic rule 3	Use the result of logic rule 3 in the logic rule.
[30]	SL Timeout 0	Use the result of timer 0 in the logic rule.
[31]	SL Timeout 1	Use the result of timer 1 in the logic rule.
[32]	SL Timeout 2	Use the result of timer 2 in the logic rule.
[33]	Digital input DI18	Use the value of DI18 in the logic rule (High = TRUE).
[34]	Digital input DI19	Use the value of DI19 in the logic rule (High = TRUE).
[35]	Digital input DI27	Use the value of DI27 in the logic rule (High = TRUE).
[36]	Digital input DI29	Use the value of DI29 in the logic rule (High = TRUE).
[37]	Digital input DI32	Use the value of DI32 in the logic rule (High = TRUE).
[38]	Digital input DI33	Use the value of DI33 in the logic rule (High = TRUE).
[39]	Start command	This logic rule is TRUE if the Adjustable frequency drive is started by any means (either via digital input, serial communication bus or other).
[40]	Drive stopped	This logic rule is TRUE if the Adjustable frequency drive is stopped or coasted by any means (either via digital input, serial communication bus or other).
[41]	Reset Trip	This logic rule is TRUE if the Adjustable frequency drive is tripped (but not trip-locked) and the reset button is pressed.
[42]	Auto Reset Trip	This logic rule is TRUE if the Adjustable frequency drive is tripped (but not trip-locked) and an automatic reset is issued.
[43]	OK Key	This logic rule is TRUE if the OK key on the LCP is pressed.

13-40 Logic Rule Boolean 1		
Array [6]		
Option:	Function:	
[44]	Reset Key	This logic rule is TRUE if the reset key on the LCP is pressed.
[45]	Left Key	This logic rule is TRUE if the left key on the LCP is pressed.
[46]	Right Key	This logic rule is TRUE if the right key on the LCP is pressed.
[47]	Up Key	This logic rule is TRUE if the up key on the LCP is pressed.
[48]	Down Key	This logic rule is TRUE if the down key on the LCP is pressed.
[50]	Comparator 4	Use the result of comparator 4 in the logic rule.
[51]	Comparator 5	Use the result of comparator 5 in the logic rule.
[60]	Logic rule 4	Use the result of logic rule 4 in the logic rule.
[61]	Logic rule 5	Use the result of logic rule 5 in the logic rule.
[70]	SL Timeout 3	Use the result of timer 3 in the logic rule.
[71]	SL Timeout 4	Use the result of timer 4 in the logic rule.
[72]	SL Timeout 5	Use the result of timer 5 in the logic rule.
[73]	SL Timeout 6	Use the result of timer 6 in the logic rule.
[74]	SL Timeout 7	Use the result of timer 7 in the logic rule.
[76]	Digital Input x30 2	
[77]	Digital Input x30 3	
[78]	Digital Input x30 4	
[80]	No Flow	
[81]	Dry Pump	
[82]	End of Curve	
[83]	Broken Belt	
[90]	ECB Drive Mode	
[91]	ECB Bypass Mode	
[92]	ECB Test Mode	
[100]	Fire Mode	

13-41 Logic Rule Operator 1		
Array [6]		
Option:	Function:	
		Select the first logical operator to use on the Boolean inputs from 13-40 Logic Rule Boolean 1 and 13-42 Logic Rule Boolean 2. [13-**] signifies the Boolean input of parameter group 13-**.
[0] *	DISABLED	Ignores 13-42 Logic Rule Boolean 2, 13-43 Logic Rule Operator 2, and 13-44 Logic Rule Boolean 3.
[1]	AND	Evaluates the expression [13-40] AND [13-42].
[2]	OR	evaluates the expression [13-40] OR [13-42].
[3]	AND NOT	evaluates the expression [13-40] AND NOT [13-42].
[4]	OR NOT	evaluates the expression [13-40] OR NOT [13-42].
[5]	NOT AND	evaluates the expression NOT [13-40] AND [13-42].
[6]	NOT OR	evaluates the expression NOT [13-40] OR [13-42].
[7]	NOT AND NOT	evaluates the expression NOT [13-40] AND NOT [13-42].
[8]	NOT OR NOT	evaluates the expression NOT [13-40] OR NOT [13-42].

13-42 Logic Rule Boolean 2		
Array [6]		
Option:	Function:	
		Select the second Boolean (TRUE or FALSE) input for the selected logic rule. See 13-40 Logic Rule Boolean 1 for further descriptions of choices and their functions.
[0] *	FALSE	
[1]	TRUE	
[2]	Running	
[3]	In range	
[4]	On reference	
[5]	Torque limit	
[6]	Current limit	
[7]	Out of current range	
[8]	Below I low	
[9]	Above I high	
[10]	Out of speed range	
[11]	Below speed low	
[12]	Above speed high	

13-42 Logic Rule Boolean 2		
Array [6]		
Option:	Function:	
[13]	Out of feedb. range	
[14]	Below feedb. low	
[15]	Above feedb. high	
[16]	Thermal warning	
[17]	Mains out of range	
[18]	Reverse	
[19]	Warning	
[20]	Alarm (trip)	
[21]	Alarm (trip lock)	
[22]	Comparator 0	
[23]	Comparator 1	
[24]	Comparator 2	
[25]	Comparator 3	
[26]	Logic rule 0	
[27]	Logic rule 1	
[28]	Logic rule 2	
[29]	Logic rule 3	
[30]	SL Timeout 0	
[31]	SL Timeout 1	
[32]	SL Timeout 2	
[33]	Digital input DI18	
[34]	Digital input DI19	
[35]	Digital input DI27	
[36]	Digital input DI29	
[37]	Digital input DI32	
[38]	Digital input DI33	
[39]	Start command	
[40]	Drive stopped	
[41]	Reset Trip	
[42]	Auto Reset Trip	
[43]	OK Key	
[44]	Reset Key	
[45]	Left Key	
[46]	Right Key	
[47]	Up Key	
[48]	Down Key	
[50]	Comparator 4	
[51]	Comparator 5	
[60]	Logic rule 4	
[61]	Logic rule 5	
[70]	SL Timeout 3	
[71]	SL Timeout 4	
[72]	SL Timeout 5	
[73]	SL Timeout 6	
[74]	SL Timeout 7	
[76]	Digital Input x30 2	
[77]	Digital Input x30 3	
[78]	Digital Input x30 4	

13-42 Logic Rule Boolean 2		
Array [6]		
Option:	Function:	
[80]	No Flow	
[81]	Dry Pump	
[82]	End of Curve	
[83]	Broken Belt	
[90]	ECB Drive Mode	
[91]	ECB Bypass Mode	
[92]	ECB Test Mode	
[100]	Fire Mode	

13-43 Logic Rule Operator 2		
Array [6]		
Option:	Function:	
		Select the second logical operator to be used on the Boolean input calculated in 13-40 Logic Rule Boolean 1, 13-41 Logic Rule Operator 1, and 13-42 Logic Rule Boolean 2, and the Boolean input coming from 13-42 Logic Rule Boolean 2. [13-44] signifies the Boolean input of 13-44 Logic Rule Boolean 3. [13-40/13-42] signifies the Boolean input calculated in 13-40 Logic Rule Boolean 1, 13-41 Logic Rule Operator 1, and 13-42 Logic Rule Boolean 2. DISABLED [0] (factory setting). select this option to ignore 13-44 Logic Rule Boolean 3.
[0] *	DISABLED	
[1]	AND	
[2]	OR	
[3]	AND NOT	
[4]	OR NOT	
[5]	NOT AND	
[6]	NOT OR	
[7]	NOT AND NOT	
[8]	NOT OR NOT	

13-44 Logic Rule Boolean 3		
Array [6]		
Option:	Function:	
		Select the third Boolean (TRUE or FALSE) input for the selected logic rule. See 13-40 Logic Rule Boolean 1 for further descriptions of choices and their functions.
[0] *	FALSE	
[1]	TRUE	
[2]	Running	

13-44 Logic Rule Boolean 3		
Array [6]		
Option:	Function:	
[3]	In range	
[4]	On reference	
[5]	Torque limit	
[6]	Current limit	
[7]	Out of current range	
[8]	Below I low	
[9]	Above I high	
[10]	Out of speed range	
[11]	Below speed low	
[12]	Above speed high	
[13]	Out of feedb. range	
[14]	Below feedb. low	
[15]	Above feedb. high	
[16]	Thermal warning	
[17]	Mains out of range	
[18]	Reverse	
[19]	Warning	
[20]	Alarm (trip)	
[21]	Alarm (trip lock)	
[22]	Comparator 0	
[23]	Comparator 1	
[24]	Comparator 2	
[25]	Comparator 3	
[26]	Logic rule 0	
[27]	Logic rule 1	
[28]	Logic rule 2	
[29]	Logic rule 3	
[30]	SL Timeout 0	
[31]	SL Timeout 1	
[32]	SL Timeout 2	
[33]	Digital input DI18	
[34]	Digital input DI19	
[35]	Digital input DI27	
[36]	Digital input DI29	
[37]	Digital input DI32	
[38]	Digital input DI33	
[39]	Start command	
[40]	Drive stopped	
[41]	Reset Trip	
[42]	Auto Reset Trip	
[43]	OK Key	
[44]	Reset Key	
[45]	Left Key	
[46]	Right Key	
[47]	Up Key	
[48]	Down Key	
[50]	Comparator 4	
[51]	Comparator 5	
[60]	Logic rule 4	

13-44 Logic Rule Boolean 3		
Array [6]		
Option:	Function:	
[61]	Logic rule 5	
[70]	SL Timeout 3	
[71]	SL Timeout 4	
[72]	SL Timeout 5	
[73]	SL Timeout 6	
[74]	SL Timeout 7	
[76]	Digital Input x30 2	
[77]	Digital Input x30 3	
[78]	Digital Input x30 4	
[80]	No Flow	
[81]	Dry Pump	
[82]	End of Curve	
[83]	Broken Belt	
[90]	ECB Drive Mode	
[91]	ECB Bypass Mode	
[92]	ECB Test Mode	
[100]	Fire Mode	

3.13.6 13-5* States

13-51 SL Controller Event		
Array [20]		
Option:	Function:	
		Select the Boolean input (TRUE or FALSE) to define the Smart Logic Controller event. See 13-02 Stop Event for further descriptions of choices and their functions.
[0] *	FALSE	
[1]	TRUE	
[2]	Running	
[3]	In range	
[4]	On reference	
[5]	Torque limit	
[6]	Current limit	
[7]	Out of current range	
[8]	Below I low	
[9]	Above I high	
[10]	Out of speed range	
[11]	Below speed low	
[12]	Above speed high	
[13]	Out of feedb. range	
[14]	Below feedb. low	
[15]	Above feedb. high	
[16]	Thermal warning	
[17]	Mains out of range	

13-51 SL Controller Event		
Array [20]		
Option:	Function:	
[18]	Reverse	
[19]	Warning	
[20]	Alarm (trip)	
[21]	Alarm (trip lock)	
[22]	Comparator 0	
[23]	Comparator 1	
[24]	Comparator 2	
[25]	Comparator 3	
[26]	Logic rule 0	
[27]	Logic rule 1	
[28]	Logic rule 2	
[29]	Logic rule 3	
[30]	SL Timeout 0	
[31]	SL Timeout 1	
[32]	SL Timeout 2	
[33]	Digital input DI18	
[34]	Digital input DI19	
[35]	Digital input DI27	
[36]	Digital input DI29	
[37]	Digital input DI32	
[38]	Digital input DI33	
[39]	Start command	
[40]	Drive stopped	
[41]	Reset Trip	
[42]	Auto Reset Trip	
[43]	OK Key	
[44]	Reset Key	
[45]	Left Key	
[46]	Right Key	
[47]	Up Key	
[48]	Down Key	
[50]	Comparator 4	
[51]	Comparator 5	
[60]	Logic rule 4	
[61]	Logic rule 5	
[70]	SL Timeout 3	
[71]	SL Timeout 4	
[72]	SL Timeout 5	
[73]	SL Timeout 6	
[74]	SL Timeout 7	
[76]	Digital Input x30 2	
[77]	Digital Input x30 3	
[78]	Digital Input x30 4	
[80]	No Flow	
[81]	Dry Pump	
[82]	End of Curve	
[83]	Broken Belt	
[90]	ECB Drive Mode	

13-51 SL Controller Event		
Array [20]		
Option:	Function:	
[91]	ECB Bypass Mode	
[92]	ECB Test Mode	
[100]	Fire Mode	

13-52 SL Controller Action		
Array [20]		
Option:	Function:	
		Select the action corresponding to the SLC event. Actions are executed when the corresponding event (defined in <i>13-51 SL Controller Event</i>) is evaluated as true. The following actions are available for selection:
[0] *	DISABLED	
[1]	No action	
[2]	Select set-up 1	Changes the active set-up (<i>0-10 Active Set-up</i>) to '1'.
[3]	Select set-up 2	Changes the active set-up (<i>0-10 Active Set-up</i>) to '2'.
[4]	Select set-up 3	Changes the active set-up (<i>0-10 Active Set-up</i>) to '3'.
[5]	Select set-up 4	Changes the active set-up (<i>0-10 Active Set-up</i>) to '4'. If the set-up is changed, it will merge with other set-up commands coming from either the digital inputs or via a serial communication bus.
[10]	Select preset ref 0	Selects preset reference 0.
[11]	Select preset ref 1	Selects preset reference 1.
[12]	Select preset ref 2	Selects preset reference 2.
[13]	Select preset ref 3	Selects preset reference 3.
[14]	Select preset ref 4	Selects preset reference 4.
[15]	Select preset ref 5	Selects preset reference 5.
[16]	Select preset ref 6	Selects preset reference 6.
[17]	Select preset ref 7	Selects preset reference 7. If the active preset reference is changed, it will merge with other preset reference commands coming from either the digital inputs or via a serial communication bus.
[18]	Select ramp 1	Selects ramp 1
[19]	Select ramp 2	Selects ramp 2
[22]	Run	Issues a start command to the Adjustable frequency drive.

13-52 SL Controller Action		
Array [20]		
Option:	Function:	
[23]	Run reverse	Issues a start reverse command to the Adjustable frequency drive.
[24]	Stop	Issues a stop command to the Adjustable frequency drive.
[26]	Dcstop	Issues a DC stop command to the Adjustable frequency drive.
[27]	Coast	The Adjustable frequency drive coasts immediately. All stop commands including the coast command stop the SLC.
[28]	Freeze output	Freezes the output frequency of the adjustable frequency drive.
[29]	Start timer 0	Starts timer 0, see <i>13-20 SL Controller Timer</i> for further description.
[30]	Start timer 1	Starts timer 1, see <i>13-20 SL Controller Timer</i> for further description.
[31]	Start timer 2	Starts timer 2, see <i>13-20 SL Controller Timer</i> for further description.
[32]	Set digital out A low	Any output with 'digital output 1' selected is low (off).
[33]	Set digital out B low	Any output with 'digital output 2' selected is low (off).
[34]	Set digital out C low	Any output with 'digital output 3' selected is low (off).
[35]	Set digital out D low	Any output with 'digital output 4' selected is low (off).
[36]	Set digital out E low	Any output with 'digital output 5' selected is low (off).
[37]	Set digital out F low	Any output with 'digital output 6' selected is low (off).
[38]	Set digital out A high	Any output with 'digital output 1' selected is high (closed).
[39]	Set digital out B high	Any output with 'digital output 2' selected is high (closed).
[40]	Set digital out C high	Any output with 'digital output 3' selected is high (closed).
[41]	Set digital out D high	Any output with 'digital output 4' selected is high (closed).
[42]	Set digital out E high	Any output with 'digital output 5' selected is high (closed).
[43]	Set digital out F high	Any output with 'digital output 6' selected is high (closed).
[60]	Reset Counter A	Resets Counter A to zero.

13-52 SL Controller Action		
Array [20]		
Option:	Function:	
[61]	Reset Counter B	Resets Counter A to zero.
[70]	Start Timer 3	Starts timer 3, see <i>13-20 SL Controller Timer</i> for further description.
[71]	Start Timer 4	Starts timer 4, see <i>13-20 SL Controller Timer</i> for further description.
[72]	Start Timer 5	Starts timer 5, see <i>13-20 SL Controller Timer</i> for further description.
[73]	Start Timer 6	Starts timer 6, see <i>13-20 SL Controller Timer</i> for further description.
[74]	Start Timer 7	Starts timer 7, see <i>13-20 SL Controller Timer</i> for further description.
[80]	Sleep Mode	
[90]	Set ECB Bypass Mode	
[91]	Set ECB Drive Mode	
[100]	Reset Alarms	

3.14 Main Menu - Special Functions -Group 14

3.14.1 14-0* Inverter Switching

14-00 Switching Pattern		
Option:	Function:	
		Select the switching pattern: 60° AVM or SFAVM.
[0] *	60 AVM	
[1]	SFAVM	

14-01 Switching Frequency		
Option:	Function:	
		Select the inverter switching frequency. Changing the switching frequency can help to reduce acoustic noise from the motor.
		NOTE! The output frequency value of the adjustable frequency drive must never exceed 1/10 of the switching frequency. When the motor is running, adjust the switching frequency in <i>14-01 Switching Frequency</i> until the motor is as noiseless as possible. See also <i>14-00 Switching Pattern</i> and the section <i>Derating</i> .
[0]	1.0 kHz	
[1]	1.5 kHz	
[2]	2.0 kHz	
[3]	2.5 kHz	
[4]	3.0 kHz	
[5]	3.5 kHz	
[6]	4.0 kHz	
[7] *	5.0 kHz	
[8]	6.0 kHz	
[9]	7.0 kHz	
[10]	8.0 kHz	
[11]	10.0 kHz	
[12]	12.0 kHz	
[13]	14.0 kHz	
[14]	16.0 kHz	

NOTE!

Enabling overmodulation can cause vibrations that may destroy the mechanics if running in field weakening areas (from 47Hz).

14-03 Overmodulation		
Option:	Function:	
[0] *	Off	Selects no overmodulation of the output voltage in order to avoid torque ripple on the motor shaft.
[1]	On	The overmodulation function generates an extra voltage of up to 8% of U_{max} output voltage without overmodulation, which results in an extra torque of 10–12% in the middle of the oversynchronous range (from 0% at nominal speed rising to approximately 12% at double nominal speed).

14-04 PWM Random		
Option:	Function:	
[0] *	Off	No change of the acoustic motor switching noise.
[1]	On	Transforms the acoustic motor switching noise from a clear ringing tone to a less noticeable 'white' noise. This is achieved by slightly and randomly altering the synchronism of the pulse width modulated output phases.

3.14.2 14-1* >Mains Power On/Off

Parameters for configuring line failure monitoring and handling.

14-10 Mains Failure		
Option:	Function:	
		Select the function at which the Adjustable frequency drive must act when the threshold set in <i>14-11 Mains Voltage at Mains Fault</i> has been reached or a <i>Mains Failure Inverse</i> command is activated via one of the digital inputs (par. 5-1*).
		Only selection [0] No function, [3] Coasting or [6] Alarm is available when <i>1-10 Motor Construction</i> is set to [1] PM non-salient SPM
[0] *	No function	The energy left in the capacitor bank will be used to "drive" the motor, but will be discharged.
[1]	Ctrl. ramp-down	The Adjustable frequency drive will perform a controlled ramp-down. <i>2-10 Brake Function</i> must be set to <i>Off</i> [0].
[3]	Coasting	The inverter will turn off and the capacitor bank will back up the control card, thus ensuring a faster restart when line power is reconnected (for short power zags).
[4]	Kinetic back-up	The Adjustable frequency drive will ride through by controlling speed for generative operation of the motor utilizing the moment of inertia of the system as long as sufficient energy is present.
[6]	Ctrl. alarm suppress	

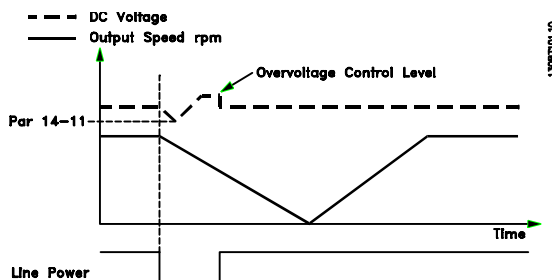

Figure 3.34 Controlled Ramp-down - short line failure. Ramping down to stop, followed by ramping up to reference.

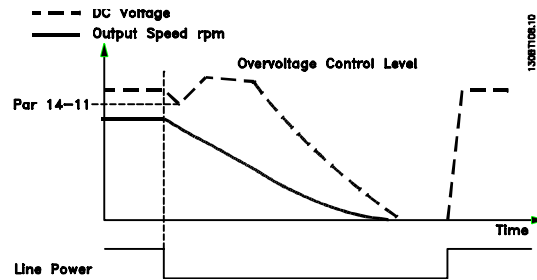

Figure 3.35 Controlled Ramp-down, longer line failure. Ramping down as long as the energy in the system allows for it, then the motor is coasted.

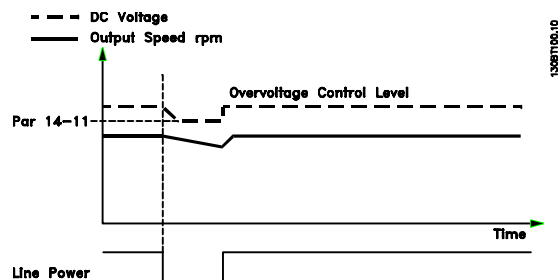

Figure 3.36 Kinetic Backup, short line failure. Ride through as long as the energy in the system allows for it.

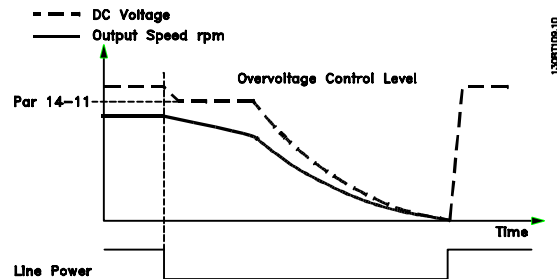

Figure 3.37 Kinetic Backup, longer line failure. The motor is coasted as soon as the energy in the system is too low.

14-11 Mains Voltage at Mains Fault		
Range:	Function:	
Size related*	[180 - 600 V]	This parameter defines the threshold voltage at which the selected function in <i>14-10 Mains Failure</i> should be activated. The detection level is at a factor $\sqrt{2}$ of the value in this parameter.

14-12 Function at Mains Imbalance		
Option:	Function:	
		Operating under severe line imbalance conditions reduces the lifetime of the motor. Conditions are considered severe if the motor operates continuously near nominal load (such as when a pump or fan runs near full speed). When a severe line imbalance is detected:
[0] *	Trip	Select <i>Trip</i> [0] to trip the Adjustable frequency drive.
[1]	Warning	Select <i>Warning</i> [1] to issue a warning.
[2]	Disabled	Select <i>Disabled</i> [2] for no action.
[3]	Derate	Select <i>Derate</i> [3] for derating the Adjustable frequency drive.

Parameters for configuring auto reset handling, special trip handling and control card self test or initialization.

14-20 Reset Mode		
Option:	Function:	
		Select the reset function after tripping. Once reset, the Adjustable frequency drive can be restarted.
[0] *	Manual reset	Select <i>Manual reset</i> [0], to perform a reset via [RESET] or via the digital inputs.
[1]	Automatic reset x 1	Select <i>Automatic reset x 1...x20</i> [1]-[12] to perform between one and twenty automatic resets after tripping.
[2]	Automatic reset x 2	
[3]	Automatic reset x 3	
[4]	Automatic reset x 4	
[5]	Automatic reset x 5	
[6]	Automatic reset x 6	
[7]	Automatic reset x 7	
[8]	Automatic reset x 8	
[9]	Automatic reset x 9	
[10]	Automatic reset x 10	
[11]	Automatic reset x 15	
[12]	Automatic reset x 20	
[13]	Infinite auto reset	Select <i>Infinite Automatic Reset</i> [13] for continuous resetting after tripping.

NOTE!

Automatic reset will also be active for resetting safe stop function.

NOTE!

The setting in *14-20 Reset Mode* is disregarded if fire mode is active (see parameter group 24-0* Fire Mode).

14-21 Automatic Restart Time		
Range:	Function:	
10 s*	[0 - 600 s]	Enter the time interval from trip to start of the automatic reset function. This parameter is active when <i>14-20 Reset Mode</i> is set to <i>Automatic reset</i> [1] - [13].

14-22 Operation Mode		
Option:	Function:	
		Use this parameter to specify normal operation, to perform tests or to initialize all parameters except <i>15-03 Power-ups</i> , <i>15-04 Over Temps</i> and <i>15-05 Over Volts</i> . This function is active only when the power is cycled (power off/power on) to the Adjustable frequency drive.
[0] *	Normal operation	Select <i>Normal operation</i> [0] for normal operation of the adjustable frequency drive with the motor in the selected application.
[1]	Control card test	Select <i>Control card test</i> [1] to test the analog and digital inputs and outputs and the +10 V control voltage. The test requires a test connector with internal connections. Use the following procedure for the control card test: <ol style="list-style-type: none"> Select <i>Control card test</i> [1]. Disconnect the line power supply and wait for the light in the display to go out. Set switches S201 (A53) and S202 (A54) = 'ON' / I. Insert the test plug (see below). Connect to the line power supply. Carry out various tests. The results are displayed on the LCP and the Adjustable frequency drive moves into an infinite loop. <i>14-22 Operation Mode</i> is automatically set to Normal operation. Carry out a power cycle to start up in normal operation after a control card test. <p>If the test is OK: LCP readout: Control Card OK. Disconnect the line power supply and remove the test plug. The green LED on the control card will light up.</p>

14-22 Operation Mode		
Option:	Function:	
	<p>If the test fails: LCP readout: Control Card I/O failure. Replace the Adjustable frequency drive or control card. The red LED on the control card is turned on. To test the plugs, connect/group the following terminals as shown below: (18 - 27 - 32), (19 - 29 - 33) and (42 - 53 - 54).</p>	
[2]	Initiali- zation	Select <i>Initialization</i> [2] to reset all parameter values to default settings, except for <i>15-03 Power-ups</i> , <i>15-04 Over Temps</i> and <i>15-05 Over Volts</i> . The Adjustable frequency drive will reset during the next power-up. <i>14-22 Operation Mode</i> will also revert to the default setting <i>Normal operation</i> [0].
[3]	Boot mode	

Figure 3.38

14-23 Typecode Setting		
Option:	Function:	
	Use this parameter to set the typecode matching the specific adjustable frequency drive. Use this parameter to set the typecode matching the specific Adjustable frequency drive.	

14-25 Trip Delay at Torque Limit		
Range:	Function:	
60 s*	[0 - 60 s]	Enter the torque limit trip delay in seconds. When the output torque reaches the torque limits (<i>4-16 Torque Limit Motor Mode</i> and <i>4-17 Torque Limit Generator Mode</i>), a warning is triggered. When the torque limit warning has been continuously present for the period specified in this parameter, the Adjustable frequency drive trips. Disable the trip delay by setting the parameter to 60 s = OFF. Thermal

14-25 Trip Delay at Torque Limit		
Range:	Function:	
	Adjustable frequency drive monitoring will still remain active.	

14-26 Trip Delay at Inverter Fault		
Range:	Function:	
Size related*	[0 - 35 s]	When the Adjustable frequency drive detects an overvoltage in the set time, tripping will be effected after the set time.

14-28 Production Settings		
Option:	Function:	
[0] *	No action	
[1]	Service reset	
[2]	Set Production Mode	

14-29 Service Code		
Range:	Function:	
0 *	[-2147483647 - 2147483647]	Service use only.

3.14.3 14-3* Current Limit Control

The Adjustable frequency drive features an integral current limit controller which is activated when the motor current, and thus the torque, is higher than the torque limits set in *4-16 Torque Limit Motor Mode* and *4-17 Torque Limit Generator Mode*.

When the current limit is reached during motor operation or regenerative operation, the Adjustable frequency drive will try to reduce torque below the preset torque limits as quickly as possible without losing control of the motor. While the current control is active, the Adjustable frequency drive can only be stopped by setting a digital input to *Coast inverse* [2] or *Coast and reset inv.* [3]. Any signal on terminals 18 to 33 will not be active until the Adjustable frequency drive is no longer near the current limit.

By using a digital input set to *Coast inverse* [2] or *Coast and reset inv.* [3], the motor does not use the ramp-down time since the Adjustable frequency drive is coasted.

14-30 Current Lim Cont, Proportional Gain		
Range:	Function:	
100 %*	[0 - 500 %]	Enter the proportional gain value for the current limit controller. Selection of a high value makes the controller react faster. Too high a setting leads to controller instability.

14-31 Current Lim Contr, Integration Time		
Range:		Function:
Size related*	[0.002 - 2.000 s]	

14-32 Current Lim Ctrl, Filter Time		
Range:		Function:
Size related*	[1.0 - 100.0 ms]	

3.14.4 14-4*Energy Optimizing

Parameters for adjusting the energy optimization level in both Variable Torque (VT) and Automatic Energy Optimization (AEO) mode.

Automatic Energy Optimization is only active if *1-03 Torque Characteristics*, is set for either *Auto Energy Optim. Compressor* [2] or *Auto Energy Optim. VT* [3].

14-40 VT Level		
Range:		Function:
66 %*	[40 - 90 %]	

NOTE!

This parameter cannot be adjusted while the motor is running.

NOTE!

This parameter is not active when *1-10 Motor Construction* is set to [1] PM non-salient SPM.

14-41 AEO Minimum Magnetization		
Range:		Function:
Size related*	[40 - 75 %]	Enter the minimum allowable magnetization for AEO. Selection of a low value reduces energy loss in the motor, but can also reduce resistance to sudden load changes.

NOTE!

This parameter is not active when *1-10 Motor Construction* is set to [1] PM non-salient SPM.

14-42 Minimum AEO Frequency		
Range:		Function:
10 Hz*	[5 - 40 Hz]	Enter the minimum frequency at which the Automatic Energy Optimization (AEO) is to be active.

NOTE!

This parameter is not active when *1-10 Motor Construction* is set to [1] PM non-salient SPM.

14-43 Motor Cos-Phi		
Range:		Function:
Size related*	[0.40 - 0.95]	The cos phi setpoint is automatically set for optimum AEO performance during AMA. This parameter should normally not be altered. However, in some situations it may be necessary to enter a new value to fine tune.

NOTE!

This parameter is not active when *1-10 Motor Construction* is set to [1] PM non-salient SPM.

3.14.5 14-5* Environment

These parameters help the Adjustable frequency drive to operate under special environmental conditions.

3.14.6 14-50 RFI 1

14-50 RFI 1		
Option:	Function:	
[0]	Off	Select <i>Off</i> [0] if the Adjustable frequency drive is fed by an isolated line power source (IT line power). If a filter is used, select <i>Off</i> [0] during charging to prevent a high leakage current making the RCD switch. In this mode, the internal RFI filter capacitors between chassis and the line power RFI filter circuit are cut-out to reduce the ground capacity currents.
[1] *	On	Select <i>On</i> [1] to ensure that the Adjustable frequency drive complies with EMC standards.

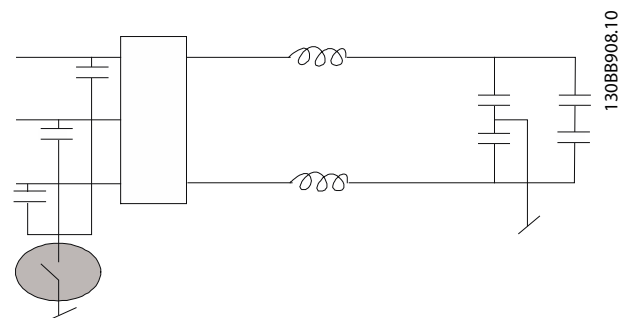

Figure 3.39

14-51 DC Link Compensation		
Option:	Function:	
		The rectified AC/DC voltage at the adjustable frequency drive's DC link is associated with voltage ripples. These ripples can increase in magnitude with increased load. These ripples are undesirable because they can generate current and torque ripples. A compensation method is used to reduce these voltage ripples at DC link. In general, DC link compensation is recommended for most applications, but care must be taken when operating in field weakening as it can generate speed oscillations at the motor shaft. In field weakening, it is recommended to turn DC link compensation off
[0]	Off	Disables DC Link Compensation.
[1] *	On	Enables DC Link Compensation.

14-52 Fan Control		
Option:	Function:	
		Select the minimum speed of the main fan.
[0] *	Auto	Select Auto [0] to run the fan only when the internal temperature of the adjustable frequency drive is in the range 95°F [+35°C] to approximately 131°F [+55°C]. The fan will run at low speed at 95°F [+35°C] and at full speed at approximately 131°F [+55°C].
[1]	On 50%	
[2]	On 75%	
[3]	On 100%	
[4]	Auto (Low temp env.)	

14-53 Fan Monitor		
Option:	Function:	
		Select which reaction the Adjustable frequency drive should take in case a fan fault is detected.
[0]	Disabled	
[1] *	Warning	
[2]	Trip	

14-55 Output Filter		
Option:	Function:	
[0] *	No Filter	
[2]	Sine-wave Filt. Fxd	

14-59 Actual Number of Inverter Units		
Range:	Function:	
Size related*	[1 - 1.]	Sets the actual number of operating inverter units.

3.14.7 14-6* Auto Derate

This group contains parameters for derating the Adjustable frequency drive in case of high temperature.

14-60 Function at Overtemperature		
Option:	Function:	
		If either heatsink or control card temperature exceeds a factory-programmed temperature limit, a warning will be activated. If the temperature increases further, select whether the Adjustable frequency drive should trip (trip locked) or derate the output current.
[0] *	Trip	The Adjustable frequency drive will trip (trip locked) and generate an alarm. Power must be cycled to reset the alarm, but will not allow restart of the motor until the heatsink temperature has dropped below the alarm limit.
[1]	Derate	If the critical temperature is exceeded, the output current will be reduced until the allowable temperature has been reached.

3.14.8 No Trip at Inverter Overload

In some pump systems, the Adjustable frequency drive has not been sized properly to yield the current needed in all points of the operational flow-head characteristic. At these points, the pump will need a current higher than the rated current of the adjustable frequency drive. The Adjustable frequency drive can yield 110% of the rated current continuously for 60 sec. If still overloaded, the Adjustable frequency drive will normally trip (causing the pump to stop by coasting) and provide an alarm.

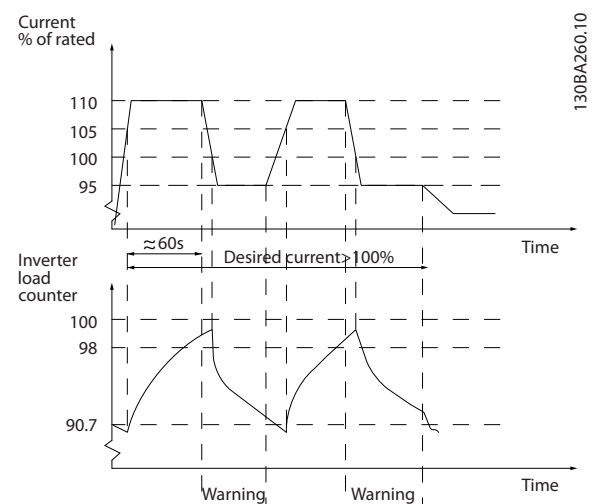

Figure 3.40

3

It may be preferable to run the pump at reduced speed for a while in case it is not possible to run continuously at demanded capacity.

Select *Function at Inverter Overload*, 14-61 *Function at Inverter Overload* to automatically reduce pump speed until the output current is below 100% of the rated current (set in 14-62 *Inv. Overload Derate Current*).

The *Function at Inverter Overload* is an alternative to letting the Adjustable frequency drive trip.

The Adjustable frequency drive estimates the load on the power section by means of an inverter load counter, which will cause a warning at 98% and a reset of the warning at 90%. At the value 100%, the Adjustable frequency drive trips and provides an alarm.

Status for the counter can be read in 16-35 *Inverter Thermal*.

If 14-61 *Function at Inverter Overload* is set to Derate, the pump speed will be reduced when the counter exceeds 98, and stay reduced until the counter has dropped below 90.7.

If 14-62 *Inv. Overload Derate Current* is set to 95%, for example, a steady overload will cause the pump speed to fluctuate between values corresponding to 110% and 95% of rated output current for the Adjustable frequency drive.

14-61 Function at Inverter Overload		
Option:	Function:	
		Is used in case of steady overload beyond the thermal limits (110% for 60 sec.).
[0] *	Trip	Choose Trip [0] to make the Adjustable frequency drive trip and provide an alarm.
[1]	Derate	Derate [1] to reduce pump speed in order to decrease the load on the power section and allowing this to cool down.

14-62 Inv. Overload Derate Current		
Range:	Function:	
95 %*	[50 - 100 %]	

3.15 Main Menu - Drive Information - Group 15

Parameter group containing adjustable frequency drive information such as operating data, hardware configuration and software versions.

3.15.1 15-0* Operating Data

15-00 Operating Hours		
Range:	Function:	
0 h*	[0 - 2147483647 h]	View how many hours the Adjustable frequency drive has run. The value is saved when the Adjustable frequency drive is turned off.

15-01 Running Hours		
Range:	Function:	
0 h*	[0 - 2147483647 h]	View how many hours the motor has run. Reset the counter in <i>15-07 Reset Running Hours Counter</i> . The value is saved when the Adjustable frequency drive is turned off.

15-02 kWh Counter		
Range:	Function:	
0 kWh*	[0 - 2147483647 kWh]	Registering the power consumption of the motor as a mean value over one hour. Reset the counter in <i>15-06 Reset kWh Counter</i> .

15-03 Power-ups		
Range:	Function:	
0 *	[0 - 2147483647]	View the number of times the Adjustable frequency drive has been powered up.

15-04 Over Temps		
Range:	Function:	
0 *	[0 - 65535]	View the number of Adjustable frequency drive temperature faults which have occurred.

15-05 Over Volts		
Range:	Function:	
0 *	[0 - 65535]	View the number of Adjustable frequency drive overvoltages which have occurred.

15-06 Reset kWh Counter		
Option:	Function:	
[0] *	Do not reset	Select <i>Do not reset</i> [0] if no reset of the kWh counter is desired.

15-06 Reset kWh Counter		
Option:	Function:	
[1]	Reset counter	Select <i>Reset</i> [1] and press [OK] to reset the kWh counter to zero (see <i>15-02 kWh Counter</i>).

NOTE!

The reset is carried out by pressing [OK].

15-07 Reset Running Hours Counter		
Option:	Function:	
[0] *	Do not reset	Select <i>Do not reset</i> [0] if no reset of the Running Hours counter is desired.
[1]	Reset counter	Select <i>Reset counter</i> [1] and press [OK] to reset the Running Hours counter (<i>15-01 Running Hours</i>) and <i>15-08 Number of Starts</i> to zero (see also <i>15-01 Running Hours</i>).

15-08 Number of Starts		
Range:	Function:	
0 *	[0 - 2147483647]	This is a readout parameter only. The counter shows the numbers of starts and stops caused by a normal Start/Stop command and/or when entering/leaving sleep mode.

NOTE!

This parameter will be reset when resetting *15-07 Reset Running Hours Counter*.

3.15.2 15-1* Data Log Settings

The Data Log enables continuous logging of up to 4 data sources (*15-10 Logging Source*) at individual rates (*15-11 Logging Interval*). A trigger event (*15-12 Trigger Event*) and window (*15-14 Samples Before Trigger*) are used to start and stop the logging conditionally.

15-10 Logging Source		
Option:	Function:	
		Select which variables are to be logged.
[0] *	None	
[1600]	Control Word	
[1601]	Reference [Unit]	
[1602]	Reference %	
[1603]	Status Word	
[1610]	Power [kW]	
[1611]	Power [hp]	

15-10 Logging Source		
Array [4]		
Option:	Function:	
[1612]	Motor voltage	
[1613]	Frequency	
[1614]	Motor Current	
[1616]	Torque [Nm]	
[1617]	Speed [RPM]	
[1618]	Motor Thermal	
[1622]	Torque [%]	
[1626]	Power Filtered [kW]	
[1627]	Power Filtered [hp]	
[1630]	DC Link Voltage	
[1632]	Brake Energy /s	
[1633]	Brake Energy /2 min	
[1634]	Heatsink Temp.	
[1635]	Inverter Thermal	
[1650]	External Reference	
[1652]	Feedback [Unit]	
[1654]	Feedback 1 [Unit]	
[1655]	Feedback 2 [Unit]	
[1656]	Feedback 3 [Unit]	
[1660]	Digital Input	
[1662]	Analog Input 53	
[1664]	Analog Input 54	
[1665]	Analog Output 42 [mA]	
[1666]	Digital Output [bin]	
[1675]	Analog In X30/11	
[1676]	Analog In X30/12	
[1677]	Analog Out X30/8 [mA]	
[1690]	Alarm Word	
[1691]	Alarm word 2	
[1692]	Warning Word	
[1693]	Warning word 2	
[1694]	Ext. Status Word	
[1695]	Ext. Status Word 2	
[1830]	Analog Input X42/1	
[1831]	Analog Input X42/3	
[1832]	Analog Input X42/5	
[1833]	Analog Out X42/7 [V]	
[1834]	Analog Out X42/9 [V]	
[1835]	Analog Out X42/11 [V]	
[1850]	Sensorless Readout [unit]	
[3110]	Bypass Status Word	

15-11 Logging Interval		
Range:	Function:	
Size related* [0.000 - 0.000]	Enter the interval in milliseconds between each sampling of the variables to be logged.	

15-12 Trigger Event		
Option:	Function:	
		Selects the trigger event. When the trigger event occurs, a window is applied to freeze the log. The log will then retain a specified percentage of samples before the occurrence of the trigger event (<i>15-14 Samples Before Trigger</i>).
[0] *	FALSE	
[1]	TRUE	
[2]	Running	
[3]	In range	
[4]	On reference	
[5]	Torque limit	
[6]	Current limit	
[7]	Out of current range	
[8]	Below I low	
[9]	Above I high	
[10]	Out of speed range	
[11]	Below speed low	
[12]	Above speed high	
[13]	Out of feedb. range	
[14]	Below feedb. low	
[15]	Above feedb. high	
[16]	Thermal warning	
[17]	Mains out of range	
[18]	Reverse	
[19]	Warning	
[20]	Alarm (trip)	
[21]	Alarm (trip lock)	
[22]	Comparator 0	
[23]	Comparator 1	
[24]	Comparator 2	
[25]	Comparator 3	
[26]	Logic rule 0	
[27]	Logic rule 1	
[28]	Logic rule 2	
[29]	Logic rule 3	
[33]	Digital input DI18	
[34]	Digital input DI19	
[35]	Digital input DI27	
[36]	Digital input DI29	
[37]	Digital input DI32	
[38]	Digital input DI33	
[50]	Comparator 4	
[51]	Comparator 5	
[60]	Logic rule 4	
[61]	Logic rule 5	

15-13 Logging Mode		
Option:	Function:	
[0] *	Log always	Select <i>Log always</i> [0] for continuous logging.
[1]	Log once on trigger	Select <i>Log once on trigger</i> [1] to conditionally start and stop logging using <i>15-12 Trigger Event</i> and <i>15-14 Samples Before Trigger</i> .

15-14 Samples Before Trigger		
Range:	Function:	
50 *	[0 - 100]	Enter the percentage of all samples prior to a trigger event which are to be retained in the log. See also <i>15-12 Trigger Event</i> and <i>15-13 Logging Mode</i> .

3.15.3 15-2* Historic Log

View up to 50 logged data items via the array parameters in this parameter group. For all parameters in the group, [0] is the most recent data and [49] the oldest data. Data is logged every time an *event* occurs (not to be confused with SLC events). *Events* in this context are defined as a change in one of the following areas

1. Digital input
2. Digital outputs (not monitored in this SW release)
3. Warning word
4. Alarm word
5. Status word
6. Control word
7. Extended status word

Events are logged with value, and time stamp in msec. The time interval between two events depends on how often *events* occur (maximum once every scan time). Data logging is continuous but if an alarm occurs, the log is saved and the values can be viewed on the display. This feature is useful, for example when carrying out service following a trip. View the historic log contained in this parameter via the serial communication port or via the display.

15-20 Historic Log: Event		
Array [50]		
Range:	Function:	
0 *	[0 - 255]	View the event type of the logged events.

15-21 Historic Log: Value		
Array [50]		
Range:	Function:	
0 *	[0 - 2147483647]	View the value of the logged event. Interpret the event values according to this table:
	Digital input	Decimal value. See <i>16-60 Digital Input</i> for description after converting to binary value.
	Digital output (not monitored in this SW release)	Decimal value. See <i>16-66 Digital Output [bin]</i> for description after converting to binary value.
	Warning word	Decimal value. See <i>16-92 Warning Word</i> for description.
	Alarm word	Decimal value. See <i>16-90 Alarm Word</i> for description.
	Status word	Decimal value. See <i>16-03 Status Word</i> for description after converting to binary value.
	Control word	Decimal value. See <i>16-00 Control Word</i> for description.
	Extended status word	Decimal value. See <i>16-94 Ext. Status Word</i> for description.
Table 3.19		

15-22 Historic Log: Time		
Array [50]		
Range:	Function:	
0 ms*	[0 - 2147483647 ms]	View the time at which the logged event occurred. Time is measured in ms since Adjustable frequency drive start. The max. value corresponds to approx. 24 days which means that the count will restart at zero after this time period.

15-23 Historic Log: Date and Time		
Range:	Function:	
Size related*	[0 - 0]	

3.15.4 15-3* Alarm Log

Parameters in this group are array parameters, where up to 10 fault logs can be viewed. [0] is the most recent logged data, and [9] the oldest. Error codes, values and time stamp can be viewed for all logged data.

15-30 Alarm Log: Error Code		
Array [10]		
Range:	Function:	
0 *	[0 - 255]	View the error code and look up its meaning in <i>4 Troubleshooting</i> .

15-31 Alarm Log: Value		
Array [10]		
Range:	Function:	
0 *	[-32767 - 32767]	View an extra description of the error. This parameter is mostly used in combination with alarm 38 'internal fault'.

15-32 Alarm Log: Time		
Array [10]		
Range:	Function:	
0 s*	[0 - 2147483647 s]	View the time when the logged event occurred. Time is measured in seconds from Adjustable frequency drive start-up.

15-33 Alarm Log: Date and Time		
Range:	Function:	
Size related*	[0 - 0]	Array parameter; Date & Time 0 - 9: This parameter shows at which time the logged event occurred.

3.15.5 15-4* Drive Identification

Parameters containing read-only information about the hardware and software configuration of the Adjustable frequency drive.

15-40 FC Type		
Range:	Function:	
0 *	[0 - 0]	View the FC type. The readout is identical to the adjustable frequency drive series power field of the type code definition, characters 1-6.

15-41 Power Section		
Range:	Function:	
0 *	[0 - 0]	View the FC type. The readout is identical to the adjustable frequency drive series power field of the type code definition, characters 7-10.

15-42 Voltage		
Range:	Function:	
0 *	[0 - 0]	View the FC type. The readout is identical to the adjustable frequency drive series power field of the type code definition, characters 11-12.

15-43 Software Version		
Range:	Function:	
0 *	[0 - 0]	View the combined SW version (or 'package version') consisting of power SW and control SW.

15-44 Ordered Typecode String		
Range:	Function:	
0 *	[0 - 0]	View the type code string used for re-ordering the Adjustable frequency drive in its original configuration.

15-45 Actual Typecode String		
Range:	Function:	
0 *	[0 - 0]	View the actual string.

15-46 Adj Freq Dr Ordering No.		
Range:	Function:	
0 *	[0 - 0]	View the 8-digit ordering number used for re-ordering the Adjustable frequency drive in its original configuration.

15-47 Power Card Ordering No.		
Range:	Function:	
0 *	[0 - 0]	View the power card ordering number.

15-48 LCP ID Num.		
Range:	Function:	
0 *	[0 - 0]	View the LCP ID number.

15-49 SW ID Control Card		
Range:	Function:	
0 *	[0 - 0]	View the control card software version number.

15-50 SW ID Power Card		
Range:	Function:	
0 *	[0 - 0]	View the power card software version number.

15-51 Adj Freq Dr Serial No.		
Range:	Function:	
0 *	[0 - 0]	View the Adjustable frequency drive serial number.

15-53 Power Card Serial Number		
Range:	Function:	
0 *	[0 - 0]	View the power card serial number.

15-59 CSIV Filename		
Range:	Function:	
Size related*	[0 - 0]	CSIV Filename readout.

3.15.6 15-6* Option Ident.

This read-only parameter group contains information about the hardware and software configuration of the options installed in slots A, B, C0 and C1.

15-60 Option Mounted		
Range:	Function:	
0 *	[0 - 0]	View the installed option type.

15-61 Option SW Version		
Range:	Function:	
0 *	[0 - 0]	View the installed option software version.

15-62 Option Ordering No		
Range:	Function:	
0 *	[0 - 0]	Shows the ordering number for the installed options.

15-63 Option Serial No		
Range:	Function:	
0 *	[0 - 0]	View the installed option serial number.

15-70 Option in Slot A		
Range:	Function:	
0 *	[0 - 0]	View the string for the option installed in slot A, and a translation of the string; for example, for string 'AX' the translation is 'No option'.

15-71 Slot A Option SW Version		
Range:	Function:	
0 *	[0 - 0]	View the software version for the option installed in slot A.

15-72 Option in Slot B		
Range:	Function:	
0 *	[0 - 0]	View the string for the option installed in slot B, and a translation of the string; for example, for string 'BX' the translation is 'No option'.

15-73 Slot B Option SW Version		
Range:	Function:	
0 *	[0 - 0]	View the software version for the option installed in slot B.

15-74 Option in Slot C0		
Range:	Function:	
0 *	[0 - 0]	View the string for the option installed in slot C, and a translation of the string; for example, for string 'CXXX' the translation is 'No option'.

15-75 Slot C0 Option SW Version		
Range:	Function:	
0 *	[0 - 0]	View the software version for the option installed in slot C.

15-76 Option in Slot C1		
Range:	Function:	
0 *	[0 - 0]	Shows the typecode string for the options (CXXXX if no option) and the translation, e.g., >No option<.

15-77 Slot C1 Option SW Version		
Range:	Function:	
0 *	[0 - 0]	Software version for the installed option in option slot C.

15-92 Defined Parameters		
Array [1000]		
Range:	Function:	
0 *	[0 - 9999]	View a list of all defined parameters in the Adjustable frequency drive. The list ends with 0.

15-93 Modified Parameters		
Array [1000]		
Range:	Function:	
0 *	[0 - 9999]	View a list of the parameters that have been changed from their default setting. The list ends with 0. Changes may not be visible until up to 30 sec. after implementation.

15-98 Drive Identification		
Range:	Function:	
0 *	[0 - 0]	

3

15-99 Parameter Metadata		
Array [23]		
Range:		Function:
0 *	[0 - 9999]	This parameter contains data used by the MCT10 software tool.

3.16 Main Menu - Data Readouts - Group 16

16-00 Control Word		
Range:		Function:
0 *	[0 - 65535]	View the control word sent from the Adjustable frequency drive via the serial communication port in hex code.

16-01 Reference [Unit]		
Range:		Function:
0.000 Reference-FeedbackUnit*	[-999999.000 - 999999.000 ReferenceFeed-backUnit]	View the present reference value applied on impulse or analog basis in the unit resulting from the configuration selected in <i>1-00 Configuration Mode</i> (Hz, Nm or RPM).

16-02 Reference %		
Range:		Function:
0.0 %*	[-200.0 - 200.0 %]	

16-03 Status Word		
Range:		Function:
0 *	[0 - 65535]	View the status word sent from the Adjustable frequency drive via the serial communication port in hex code.

16-05 Main Actual Value [%]		
Range:		Function:
0.00 %*	[-100.00 - 100.00 %]	View the two-byte word sent with the status word to the bus master reporting the main actual value.

16-09 Custom Readout		
Range:		Function:
0.00 CustomReadoutUnit*	[-999999.99 - 999999.99 CustomReadoutUnit]	View the user-defined readouts as defined in <i>0-30 Custom Readout Unit</i> , <i>0-31 Custom Readout Min Value</i> and <i>0-32 Custom Readout Max Value</i> .

3.16.1 16-1* Motor Status

16-10 Power [kW]		
Range:		Function:
0.00 kW*	[0.00 - 10000.00 kW]	Displays motor power in kW. The value shown is calculated on the basis of the actual motor voltage and motor current. The value is filtered, and therefore approx. 30ms may pass from when an input value changes to when the data readout values change. The resolution of readout value on serial communication bus is in 10 W steps.

16-11 Power [hp]		
Range:		Function:
0.00 hp*	[0.00 - 10000.00 hp]	View the motor power in HP. The value shown is calculated on the basis of the actual motor voltage and motor current. The value is filtered, and therefore approximately 30ms may pass from when an input value changes to when the data readout values change.

16-12 Motor voltage		
Range:		Function:
0.0 V*	[0.0 - 6000.0 V]	View the motor voltage, a calculated value used for controlling the motor.

16-13 Frequency		
Range:		Function:
0.0 Hz*	[0.0 - 6500.0 Hz]	View the motor frequency, without resonance dampening.

16-14 Motor Current		
Range:		Function:
0.00 A*	[0.00 - 10000.00 A]	View the motor current measured as a mean value, IRMS. The value is filtered, and thus approximately 30ms may pass from when an input value changes to when the data readout values change.

16-15 Frequency [%]		
Range:		Function:
0.00 %*	[-100.00 - 100.00 %]	

16-16 Torque [Nm]		
Range:		Function:
0.0 Nm*	[-30000.0 - 30000.0 Nm]	View the torque value with sign, applied to the motor shaft. Linearity is not exact between 110% motor current and torque in relation to the rated torque. Some motors supply more than 160% torque. Consequently, the min. value and the max. value will depend on the max. motor current as well as the motor used. The value is filtered, and thus approx. 1.3 sec. may pass from when an input changes value to when the data readout values change.

16-17 Speed [RPM]		
Range:		Function:
0 RPM*	[-30000 - 30000 RPM]	View the current motor RPM.

16-18 Motor Thermal		
Range:		Function:
0 %*	[0 - 100 %]	View the calculated thermal load on the motor. The cut-out limit is 100%. The basis for calculation is the ETR function selected in <i>1-90 Motor Thermal Protection</i> .

16-22 Torque [%]		
Range:		Function:
0 %*	[-200 - 200 %]	This is a readout parameter only. Shows the actual torque yielded in percentage of the rated torque, based on the setting of the motor size and rated speed in <i>1-20 Motor Power [kW]</i> or <i>1-21 Motor Power [HP]</i> and <i>1-25 Motor Nominal Speed</i> . This is the value monitored by the <i>Broken Belt Function</i> set in par. 22-6*.

16-26 Power Filtered [kW]		
Range:		Function:
0.000 kW*	[0.000 - 10000.000 kW]	Motor power consumption. The value shown is calculated on basis of the actual motor voltage and motor current. The value is filtered, and a few sec. may pass from when an input value changes to when the data readout values change.

16-27 Power Filtered [hp]		
Range:		Function:
0.000 hp*	[0.000 - 10000.000 hp]	Motor power in HP. The value shown is calculated on the basis of actual motor voltage and motor current. The value is filtered, and a few sec. may

16-27 Power Filtered [hp]		
Range:		Function:
		pass from when an input value changes to when the data readout values change.

3.16.2 16-3* Drive Status

16-30 DC Link Voltage		
Range:		Function:
0 V*	[0 - 10000 V]	View a measured value. The value is filtered with an 30ms time constant.

16-32 Brake Energy /s		
Range:		Function:
0.000 kW*	[0.000 - 10000.000 kW]	View the braking energy transmitted to an external brake resistor, stated as an instantaneous value.

16-33 Brake Energy /2 min		
Range:		Function:
0.000 kW*	[0.000 - 10000.000 kW]	View the braking energy transmitted to an external brake resistor. The mean power is calculated on an average basis for the most recent 120 sec.

16-34 Heatsink Temp.		
Range:		Function:
0 °C*	[0 - 255 °C]	

16-35 Inverter Thermal		
Range:		Function:
0 %*	[0 - 100 %]	View the percentage load on the inverter.

16-36 Inv. Nom. Current		
Range:		Function:
Size related*	[0.01 - 10000.00 A]	

16-37 Inv. Max. Current		
Range:		Function:
Size related*	[0.01 - 10000.00 A]	

16-38 SL Controller State		
Range:		Function:
0 *	[0 - 100]	View the state of the event under execution by the SL controller.

16-39 Control Card Temp.		
Range:	Function:	
0 °C*	[0 - 100 °C]	

16-40 Logging Buffer Full		
Option:	Function:	
	View whether the logging buffer is full (see parameter group 15-1*). The logging buffer will never be full when 15-13 Logging Mode is set to Log always [0].	
[0] *	No	
[1]	Yes	

16-43 Timed Actions Status		
View the timed actions mode.		
Option:	Function:	
[0] *	Timed Actions Auto	
[1]	Timed Actions Disab.	
[2]	Constant On Actions	
[3]	Constant Off Actions	

16-49 Current Fault Source		
Range:	Function:	
0 *	[0 - 8]	Value indicates source of current fault, including: short circuit, overcurrent and phase imbalance (from left): [1-4] Inverter, [5-8] Rectifier, [0] No fault recorded

After a short circuit alarm (imax2) or over current alarm (imax1 or phase imbalance), this will contain the power card number associated with the alarm. It only holds one number so it will indicate the highest priority power card number (master first). The value will persist on power cycle but if a new alarm occurs it will be overwritten with the new power card number (even if it a lower priority number). The value will only be cleared when the alarm log is cleared (e.g., a 3-finger reset would reset the readout to 0).

3.16.3 16-5* Ref. & Feedb.

16-50 External Reference		
Range:	Function:	
0.0 *	[-200.0 - 200.0]	View the total reference, the sum of digital, analog, preset, bus and freeze references, plus catch-up and slow-down.

16-52 Feedback [Unit]		
Range:	Function:	
0.000 ProcessCtrlUnit*	[-999999.999 - 999999.999 ProcessCtrlUnit]	View value of resulting feedback value after processing of Feedback 1-3 (see 16-54 Feedback 1 [Unit],

16-52 Feedback [Unit]		
Range:	Function:	
		16-55 Feedback 2 [Unit] and par. 16-56) in the feedback manager. See parameter group 20-0* Feedback. The value is limited by settings in 20-13 Minimum Reference/Feedb. and 20-14 Maximum Reference/Feedb.. Units as set in 20-12 Reference/Feedback Unit.

16-53 Digi Pot Reference		
Range:	Function:	
0.00 *	[-200.00 - 200.00]	View the contribution of the digital potentiometer to the actual reference.

16-54 Feedback 1 [Unit]		
Range:	Function:	
0.000 ProcessCtrlUnit*	[-999999.999 - 999999.999 ProcessCtrlUnit]	View value of Feedback 1, see parameter group 20-0* Feedback. The value is limited by settings in 20-13 Minimum Reference/Feedb. and 20-14 Maximum Reference/Feedb.. Units as set in 20-12 Reference/Feedback Unit.

16-55 Feedback 2 [Unit]		
Range:	Function:	
0.000 ProcessCtrlUnit*	[-999999.999 - 999999.999 ProcessCtrlUnit]	View value of Feedback 2, see parameter group 20-0* Feedback. The value is limited by settings in 20-13 Minimum Reference/Feedb. and 20-14 Maximum Reference/Feedb.. Units as set in 20-12 Reference/Feedback Unit.

16-56 Feedback 3 [Unit]		
Range:		Function:
0.000 ProcessCtrlUnit*	[-999999.999 - 999999.999 ProcessCtrlUnit]	View value of Feedback 3, see parameter group 20-0* <i>Feedback</i> . The value is limited by settings in 20-13 <i>Minimum Reference/Feedb.</i> and 20-14 <i>Maximum Reference/Feedb.</i> Units as set in 20-12 <i>Reference/Feedback Unit</i> .

16-58 PID Output [%]		
Range:		Function:
0.0 %*	[0.0 - 100.0 %]	

3.16.4 16-6* Inputs & Outputs

16-60 Digital Input		
Range:		Function:
0 *	[0 - 1023]	View the signal states from the active digital inputs. Example: Input 18 corresponds to bit no. 5, '0' = no signal, '1' = connected signal. Bit 6 works in the opposite way, on = '0', off = '1' (safe stop input).
Bit 0	Digital input term. 33	
Bit 1	Digital input term. 32	
Bit 2	Digital input term. 29	
Bit 3	Digital input term. 27	
Bit 4	Digital input term. 19	
Bit 5	Digital input term. 18	
Bit 6	Digital input term. 37	
Bit 7	Digital input GP I/O term. X30/4	
Bit 8	Digital input GP I/O term. X30/3	
Bit 9	Digital input GP I/O term. X30/2	
Bit 10-63	Reserved for future terminals	

Table 3.23

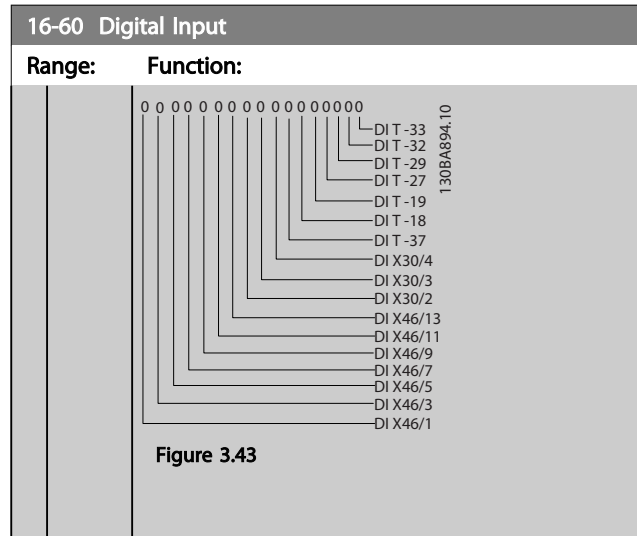

16-61 Terminal 53 Switch Setting		
Option:		Function:
		View the setting of input terminal 53. Current = 0; Voltage = 1.
[0]	Current	
[1]	Voltage	
[2]	Pt 1000 [°C]	
[3]	Pt 1000 [°F]	
[4]	Ni 1000 [°C]	
[5]	Ni 1000 [°F]	

16-62 Analog Input 53		
Range:		Function:
0.000 *	[-20.000 - 20.000]	View the actual value at input 53.

16-63 Terminal 54 Switch Setting		
Option:		Function:
		View the setting of input terminal 54. Current = 0; Voltage = 1.
[0]	Current	
[1]	Voltage	
[2]	Pt 1000 [°C]	
[3]	Pt 1000 [°F]	
[4]	Ni 1000 [°C]	
[5]	Ni 1000 [°F]	

16-64 Analog Input 54		
Range:		Function:
0.000 *	[-20.000 - 20.000]	View the actual value at input 54.

16-65 Analog Output 42 [mA]		
Range:	Function:	
0.000 * [0.000 - 30.000]	View the actual value at output 42 in mA. The value shown reflects the selection in 6-50 Terminal 42 Output.	

16-66 Digital Output [bin]		
Range:	Function:	
0 * [0 - 15]	View the binary value of all digital outputs.	

16-67 Pulse Input #29 [Hz]		
Range:	Function:	
0 * [0 - 130000]	View the actual frequency rate on terminal 29.	

16-68 Pulse Input #33 [Hz]		
Range:	Function:	
0 * [0 - 130000]	View the actual value of the frequency applied at terminal 33 as an impulse input.	

16-69 Pulse Output #27 [Hz]		
Range:	Function:	
0 * [0 - 40000]	View the actual value of impulses applied to terminal 27 in digital output mode.	

16-70 Pulse Output #29 [Hz]		
Range:	Function:	
0 * [0 - 40000]	View the actual value of pulses to terminal 29 in digital output mode.	

16-71 Relay Output [bin]		
Range:	Function:	
0 * [0 - 511]	View the settings of all relays.	
<p>Readout choice (Par. 16-71): Relay output (bin):</p> <p>Figure 3.45</p>		

16-72 Counter A		
Range:	Function:	
0 * [-2147483648 - 2147483647]	View the present value of Counter A. Counters are useful as comparator operands, see 13-10 Comparator Operand.	

16-72 Counter A		
Range:	Function:	
	The value can be reset or changed either via digital inputs (parameter group 5-1*) or by using an SLC action (13-52 SL Controller Action).	

16-73 Counter B		
Range:	Function:	
0 * [-2147483648 - 2147483647]	View the present value of Counter B. Counters are useful as comparator operands (13-10 Comparator Operand). The value can be reset or changed either via digital inputs (parameter group 5-1*) or by using an SLC action (13-52 SL Controller Action).	

16-75 Analog In X30/11		
Range:	Function:	
0.000 * [-20.000 - 20.000]	View the actual value at input X30/11 of MCB 101.	

16-76 Analog In X30/12		
Range:	Function:	
0.000 * [-20.000 - 20.000]	View the actual value at input X30/12 of MCB 101.	

16-77 Analog Out X30/8 [mA]		
Range:	Function:	
0.000 * [0.000 - 30.000]	View the actual value at input X30/8 in mA.	

3.16.5 16-8* Serial communication bus & FC Port

Parameters for reporting the BUS references and control words.

16-80 Fieldbus CTW 1		
Range:	Function:	
0 * [0 - 65535]	View the two-byte control word (CTW) received from the bus master. Interpretation of the control word depends on the Serial communication bus option installed and the control word profile selected in 8-10 Control Profile. For more information, please refer to the relevant Serial communication bus manual.	

16-82 Fieldbus REF 1		
Range:	Function:	
0 * [-200 - 200]	View the two-byte word sent with the control word from the bus master to set the reference value. For more information, refer to the relevant serial communication bus manual.	

16-84 Comm. Option Status		
Range:	Function:	
0 * [0 - 65535]	View the extended Serial communication bus comm. option status word. For more information, please refer to the relevant Serial communication bus manual.	

16-85 FC Port CTW 1		
Range:	Function:	
0 * [0 - 65535]	View the two-byte control word (CTW) received from the bus master. Interpretation of the control word depends on the Serial communication bus option installed and the control word profile selected in <i>8-10 Control Profile</i> .	

16-86 FC Port REF 1		
Range:	Function:	
0 * [-200 - 200]	View the two-byte status word (STW) sent to the bus master. Interpretation of the status word depends on the serial communication bus option installed and the control word profile selected in <i>8-10 Control Profile</i> .	

3.16.6 16-9* Diagnosis Readouts

16-90 Alarm Word		
Range:	Function:	
0 * [0 - 4294967295]	View the alarm word sent via the serial communication port in hex code.	

16-91 Alarm word 2		
Range:	Function:	
0 * [0 - 4294967295]	View the alarm word 2 sent via the serial communication port in hex code.	

16-92 Warning Word		
Range:	Function:	
0 * [0 - 4294967295]	View the warning word sent via the serial communication port in hex code.	

16-93 Warning word 2		
Range:	Function:	
0 * [0 - 4294967295]	View the warning word 2 sent via the serial communication port in hex code.	

16-94 Ext. Status Word		
Range:	Function:	
0 * [0 - 4294967295]	Returns the extended status word sent via the serial communication port in hex code.	

16-95 Ext. Status Word 2		
Range:	Function:	
0 * [0 - 4294967295]	Returns the extended warning word 2 sent via the serial communication port in hex code.	

16-96 Maintenance Word		
Range:	Function:	
0 * [0 - 4294967295]	Readout of the Preventive Maintenance Word. The bits reflect the status for the programmed preventive maintenance events in parameter group 23-1*. 13 bits represent combinations of all the possible items: <ul style="list-style-type: none"> • Bit 0: Motor bearings • Bit 1: Pump bearings • Bit 2: Fan bearings • Bit 3: Valve • Bit 4: Pressure transmitter • Bit 5: Flow transmitter • Bit 6: Temperature transmitter • Bit 7: Pump seals • Bit 8: Fan belt • Bit 9: Filter • Bit 10: Drive cooling fan • Bit 11: Drive system health check • Bit 12: Warranty • Bit 13: Maintenance Text 0 • Bit 14: Maintenance Text 1 • Bit 15: Maintenance Text 2 • Bit 16: Maintenance Text 3 • Bit 17: Maintenance Text 4 	

16-96 Maintenance Word														
Range:	Function:													
	Position 4 ⇒	Valve	Fan bearings	Pump bearings	Motor bearings									
	Position 3 ⇒	Pump seals	Temperature transmitter	Flow transmitter	Pressure transmitter									
	Position 2 ⇒	Drive system health check	Drive cooling fan	Filter	Fan belt									
	Position 1 ⇒				Warranty									
	0 _{hex}	-	-	-	-									
	1 _{hex}	-	-	-	+									
	2 _{hex}	-	-	+	-									
	3 _{hex}	-	-	+	+									
	4 _{hex}	-	+	-	-									
	5 _{hex}	-	+	-	+									
	6 _{hex}	-	+	+	-									
	7 _{hex}	-	+	+	+									
	8 _{hex}	+	-	-	-									
	9 _{hex}	+	-	-	+									
	A _{hex}	+	-	+	-									
	B _{hex}	+	-	+	+									
	C _{hex}	+	+	-	-									
	D _{hex}	+	+	-	+									
	E _{hex}	+	+	+	-									
	F _{hex}	+	+	+	+									
<p>Table 3.26</p> <p>Example: The Preventive Maintenance Word shows 040A_{hex}.</p> <table border="1"> <thead> <tr> <th>Position</th> <th>1</th> <th>2</th> <th>3</th> <th>4</th> </tr> </thead> <tbody> <tr> <td>hex value</td> <td>0</td> <td>4</td> <td>0</td> <td>A</td> </tr> </tbody> </table> <p>Table 3.27</p> <p>The first digit 0 indicates that no items from the fourth row requires maintenance The second digit 4 refers to the third row indicating that the drive cooling fan requires maintenance The third digit 0 indicates that no items from the second row require maintenance The fourth digit A refers to the top row indicating that the valve and the pump bearings require maintenance</p>					Position	1	2	3	4	hex value	0	4	0	A
Position	1	2	3	4										
hex value	0	4	0	A										

3.17 Main Menu - Data Readouts 2 - Group 18

3.17.1 18-0* Maintenance Log

This group contains the last ten preventive maintenance events. Maintenance Log 0 is the latest and Maintenance Log 9 the oldest.

By selecting one of the logs and pressing [OK], the Maintenance Item, Action and time of the occurrence can be found in *18-00 Maintenance Log: Item* – *18-03 Maintenance Log: Date and Time*.

The alarm log button on the LCP allows access to both alarm log and maintenance log.

18-00 Maintenance Log: Item		
Array [10]. Array parameter; Error code 0-9: The meaning of the error code can be found in the Troubleshooting section of the Design Guide.		
Range:	Function:	
0 *	[0 - 255]	Locate the meaning of the maintenance item in the description of <i>23-10 Maintenance Item</i> .

18-01 Maintenance Log: Action		
Array [10]. Array parameter; Error code 0-9: The meaning of the error code can be found in the Troubleshooting section of the Design Guide.		
Range:	Function:	
0 *	[0 - 255]	Locate the meaning of the maintenance item in the description of <i>23-11 Maintenance Action</i> .

18-02 Maintenance Log: Time		
Array [10]. Array parameter; Time 0-9: This parameter shows at which time the logged event occurred. Time is measured in seconds since start of the adjustable frequency drive.		
Range:	Function:	
0 s*	[0 - 2147483647 s]	Shows when the logged event occurred. Time is measured in seconds since last power-up.

18-03 Maintenance Log: Date and Time		
Array [10]		
Range:	Function:	
Size related*	[0 - 0]	Shows when the logged event occurred.
<p>NOTE!</p> <p>This requires that the date and time is programmed in <i>0-70 Date and Time</i>.</p> <p>Date format depends on the setting in <i>0-71 Date Format</i>, while the time format depends on the setting in <i>0-72 Time Format</i>.</p> <p>NOTE!</p> <p>The Adjustable frequency drive has no backup of the clock function and the set date/time will reset to default (2000-01-01 00:00) after a power-down unless a Real Time Clock module with backup is installed. In <i>0-79 Clock Fault</i>, it is possible to program for a Warning in case the clock has not been set properly, e.g., after a power-down. Incorrect setting of the clock will affect the time stamps for the Maintenance Events.</p>		

NOTE!

When mounting an analog I/O MCB 109 option card, a battery backup of date and time is included.

3.17.2 18-1* Fire Mode Log

The log covers the latest 10 faults which have been suppressed by the fire mode function. See *par. 24-0*, Fire Mode*. The log can be viewed either via the below parameters or by pressing the Alarm Log button on the LCP and select Fire Mode Log. It is not possible to reset the fire mode log.

18-10 Fire Mode Log: Event		
Range:	Function:	
0 *	[0 - 255]	This parameter contains an array with 10 elements. The number read represents an error code, which corresponds to a specific alarm. This can be found in the Troubleshooting section in the Design Guide.

18-11 Fire Mode Log: Time		
Range:		Function:
0 s*	[0 - 2147483647 s]	This parameter contains an array with 10 elements. The parameter shows at which time the logged event occurred. Time is measured in seconds since the first start of the motor.

18-12 Fire Mode Log: Date and Time		
Range:		Function:
Size related*	[0 - 0]	This parameter contains an array with 10 elements. The parameter shows at which date and time the logged event occurred. The function relies on the actual date and time having been set in <i>0-70 Date and Time</i> . Note: There is no built-in battery backup of the clock. An external backup must be used, e.g., the one in the MCB 109 Analog I/O option card. See Clock Settings, parameter group 0-7*.

18-33 Analog Out X42/7 [V]		
Range:		Function:
0.000 *	[0.000 - 30.000]	Readout of the value of the signal applied to terminal X42/7 on the Analog I/O Card. The value shown reflects the selection in <i>26-40 Terminal X42/7 Output</i> .

18-34 Analog Out X42/9 [V]		
Range:		Function:
0.000 *	[0.000 - 30.000]	Readout of the value of the signal applied to terminal X42/9 on the Analog I/O Card. The value shown reflects the selection in <i>26-50 Terminal X42/9 Output</i> .

18-35 Analog Out X42/11 [V]		
Range:		Function:
0.000 *	[0.000 - 30.000]	Readout of the value of the signal applied to terminal X42/11 on the Analog I/O Card. The value shown reflects the selection in <i>26-60 Terminal X42/11 Output</i> .

3.17.3 18-3* Analog I/O

Parameters for reporting the digital and analog I/O ports.

18-30 Analog Input X42/1		
Range:		Function:
0.000 *	[-20.000 - 20.000]	Readout of the value of the signal applied to terminal X42/1 on the Analog I/O Card. The units of the value shown in the LCP will correspond to the mode selected in <i>26-00 Terminal X42/1 Mode</i> .

18-31 Analog Input X42/3		
Range:		Function:
0.000 *	[-20.000 - 20.000]	Readout of the value of the signal applied to terminal X42/3 on the analog I/O card. The units of the value shown in the LCP will correspond to the mode selected in <i>26-01 Terminal X42/3 Mode</i> .

18-32 Analog Input X42/5		
Range:		Function:
0.000 *	[-20.000 - 20.000]	Readout of the value of the signal applied to terminal X42/5 on the analog I/O card. The units of the value shown in the LCP will correspond to the mode selected in <i>26-02 Terminal X42/5 Mode</i> .

3.17.4 18-5* Ref. & Feedb.

NOTE!

Sensorless Readout requires set up by MCT 10 with sensorless specific plug-in.

18-50 Sensorless Readout [unit]		
Range:		Function:
0.000 SensorlessUnit*	[-999999.999 - 999999.999 SensorlessUnit]	

3.18 Main Menu - Adjustable Frequency Drive Closed-loop - Group 20

This parameter group is used for configuring the closed-loop PID Controller that controls the output frequency of the adjustable frequency drive.

3

3.18.1 20-0* Feedback

This parameter group is used to configure the feedback signal for the adjustable frequency drive's Closed-Loop PID controller. Whether the Adjustable frequency drive is in closed-loop mode or open-loop mode, the feedback signals can also be shown on the adjustable frequency drive's display, be used to control an adjustable frequency drive analog output, and be transmitted over various serial communication protocols.

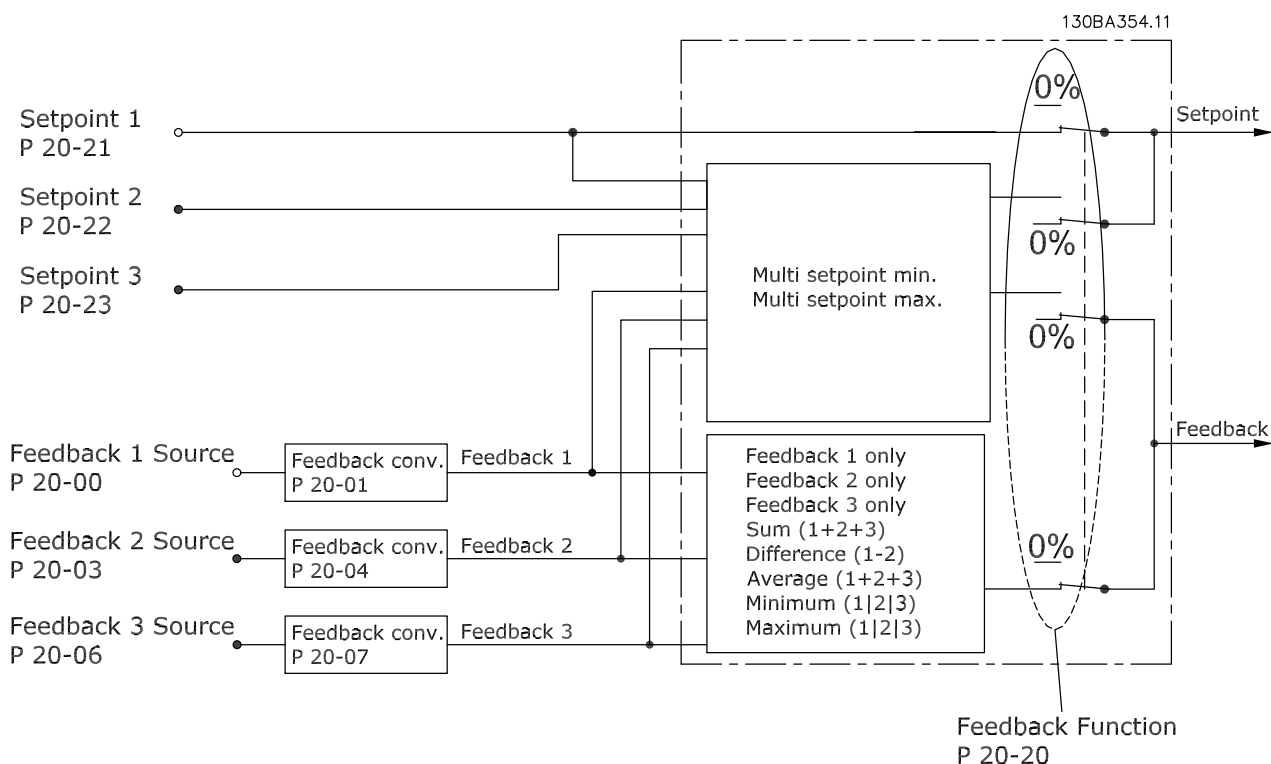

Figure 3.46

20-00 Feedback 1 Source	
Option:	Function:
[0]	No function
[1]	Analog input 53

20-00 Feedback 1 Source	
Option:	Function:
[2] *	Analog input 54
[3]	Pulse input 29
[4]	Pulse input 33
[7]	Analog input X30/11
[8]	Analog input X30/12
[9]	Analog Input X42/1
[10]	Analog Input X42/3
[11]	Analog Input X42/5
[15]	Analog Input X48/2
[100]	Bus feedback 1
[101]	Bus feedback 2
[102]	Bus feedback 3

20-00 Feedback 1 Source		
Option:	Function:	
[104]	Sensorless Flow	Requires set up by MCT 10 Set-up Software with sensorless specific plug-in.
[105]	Sensorless Pressure	Requires set up by MCT 10 Set-up Software with sensorless specific plug-in.

NOTE!

If a feedback is not used, its source must be set to *No Function* [0]. *20-20 Feedback Function* determines how the three possible feedbacks will be used by the PID controller.

20-01 Feedback 1 Conversion		
Option:	Function:	
		This parameter allows a conversion function to be applied to Feedback 1.
[0]	Linear	<i>Linear</i> [0] has no effect on the feedback.
[1]	Square root	<i>Square root</i> [1] is commonly used when a pressure sensor is used to provide flow feedback $((flow \propto \sqrt{pressure}))$.
[2]	Pressure to temperature	<i>Pressure to temperature</i> [2] is used in compressor applications to provide temperature feedback using a pressure sensor. The temperature of the refrigerant is calculated using the following formula: $Temperature = \frac{A2}{(ln(Pe + 1) - A1) - A3}$, where A1, A2 and A3 are refrigerant-specific constants. The refrigerant must be selected in <i>20-30 Refrigerant</i> . <i>20-21 Setpoint 1</i> through <i>20-23 Setpoint 3</i> allow the values of A1, A2 and A3 to be entered for a refrigerant that is not listed in <i>20-30 Refrigerant</i> .
[3]	Pressure to flow	<i>Pressure to flow</i> is used in applications where the air flow in a duct is to be controlled. The feedback signal is represented by a dynamic pressure measurement (pitot tube). $Flow = Duct\ Area \times \sqrt{Dynamic\ Pressure} \times Air\ Density\ Factor$ See also <i>20-34 Duct 1 Area [m2]</i> through <i>20-38 Air Density Factor [%]</i> for setting of duct area and air density.
[4]	Velocity to flow	<i>Velocity to flow</i> is used in applications where the air flow in a duct is to be controlled. The feedback signal is represented by an air velocity measurement. $Flow = Duct\ Area \times Air\ Velocity$

20-01 Feedback 1 Conversion		
Option:	Function:	
		See also <i>20-34 Duct 1 Area [m2]</i> through <i>20-37 Duct 2 Area [in2]</i> for setting of duct area.

20-02 Feedback 1 Source Unit		
Option:	Function:	
		This parameter determines the unit that is used for this feedback source, prior to applying the feedback conversion of <i>20-01 Feedback 1 Conversion</i> . This unit is not used by the PID controller.
[0]	*	
[1]	%	
[5]	PPM	
[10]	min	
[11]	RPM	
[12]	PULSE/s	
[20]	liter / sec.	
[21]	liter / min	
[22]	liter / hr.	
[23]	m ³ / sec.	
[24]	m ³ /min	
[25]	m ³ / hr.	
[30]	kg / sec.	
[31]	kg/min	
[32]	kg / hr.	
[33]	ton / min	
[34]	ton / hr.	
[40]	m / sec.	
[41]	m/min	
[45]	m	
[60]	°C	
[70]	mbar	
[71]	bar	
[72]	Pa	
[73]	kPa	
[74]	m WG	
[75]	mm Hg	
[80]	kW	
[120]	GPM	
[121]	gal / sec.	
[122]	gal/min	
[123]	gal / hr.	
[124]	CFM	
[125]	ft ³ /s	
[126]	ft ³ /min	
[127]	ft ³ /h	
[130]	lbs / sec.	
[131]	lbs / min.	
[132]	lbs / hr.	

20-02 Feedback 1 Source Unit	
Option:	Function:
[140]	ft/s
[141]	ft/min
[145]	ft
[160]	°F
[170]	psi
[171]	lb/in ²
[172]	in. wtr. gage
[173]	ft WG
[174]	in Hg
[180]	HP

NOTE!

This parameter is only available when using pressure to temperature feedback conversion.

If the choice Linear [0] is selected in *20-01 Feedback 1 Conversion*, then the setting of any choice in *20-02 Feedback 1 Source Unit* does not matter as conversion will be one-to-one.

20-03 Feedback 2 Source	
Option:	Function:
	See 20-00 Feedback 1 Source for details.
[0] *	No function
[1]	Analog input 53
[2]	Analog input 54
[3]	Pulse input 29
[4]	Pulse input 33
[7]	Analog input X30/11
[8]	Analog input X30/12
[9]	Analog Input X42/1
[10]	Analog Input X42/3
[11]	Analog Input X42/5
[15]	Analog Input X48/2
[100]	Bus feedback 1
[101]	Bus feedback 2
[102]	Bus feedback 3

20-04 Feedback 2 Conversion	
Option:	Function:
	See 20-01 Feedback 1 Conversion for details.
[0] *	Linear
[1]	Square root
[2]	Pressure to temperature
[3]	Pressure to flow
[4]	Velocity to flow

20-05 Feedback 2 Source Unit	
Option:	Function:
	See 20-02 Feedback 1 Source Unit for details.

20-06 Feedback 3 Source	
Option:	Function:
	See 20-00 Feedback 1 Source for details.
[0] *	No function
[1]	Analog input 53
[2]	Analog input 54
[3]	Pulse input 29
[4]	Pulse input 33
[7]	Analog input X30/11
[8]	Analog input X30/12
[9]	Analog Input X42/1
[10]	Analog Input X42/3
[11]	Analog Input X42/5
[15]	Analog Input X48/2
[100]	Bus feedback 1
[101]	Bus feedback 2
[102]	Bus feedback 3

20-07 Feedback 3 Conversion	
Option:	Function:
	See 20-01 Feedback 1 Conversion for details.
[0] *	Linear
[1]	Square root
[2]	Pressure to temperature
[3]	Pressure to flow
[4]	Velocity to flow

20-08 Feedback 3 Source Unit	
Option:	Function:
	See 20-02 Feedback 1 Source Unit for details.

20-12 Reference/Feedback Unit	
Option:	Function:
	See 20-02 Feedback 1 Source Unit for details.

20-13 Minimum Reference/Feedb.		
Range:		Function:
0.000 ProcessCtrlUnit*	[-999999.999 - par. 20-14 ProcessCtrlUnit]	Enter the desired minimum value for the remote reference when operating with <i>1-00 Configuration Mode</i> set for Closed-loop [3] operation. Units are set in <i>20-12 Reference/Feedback Unit</i> . Minimum feedback will be -200% of either the value set in <i>20-13 Minimum Reference/Feedb.</i> or in <i>20-14 Maximum Reference/Feedb.</i> , which ever numeric value is the highest.

NOTE!

If operating with *1-00 Configuration Mode* set for Open-loop [0], *3-02 Minimum Reference* must be used.

20-14 Maximum Reference/Feedb.		
Range:		Function:
100.000 ProcessCtrlUnit*	[par. 20-13 - 999999.999 ProcessCtrlUnit]	Enter the maximum reference/feedback for closed-loop operation. The setting determines the highest value obtainable by summing all reference sources for closed-loop operation. The setting determines 100% feedback in open-loop and closed-loop (total feedback range: -200% to +200%).

NOTE!

If operating with *1-00 Configuration Mode* set for Open-loop [0], *3-03 Maximum Reference* must be used.

NOTE!

The dynamics of the PID controller will depend on the value set in this parameter. See also *20-93 PID Proportional Gain*.

20-13 Minimum Reference/Feedb. and *20-14 Maximum Reference/Feedb.* also determine the feedback range when using feedback for display readout with *1-00 Configuration Mode* set for Open-loop [0]. Same condition as above.

3.18.2 20-2* Feedback & Setpoint

This parameter group is used to determine how the adjustable frequency drive's PID controller will use the three possible feedback signals to control the output frequency of the adjustable frequency drive. This group is also used to store the three internal setpoint references.

20-20 Feedback Function		
Option:	Function:	
		This parameter determines how the three possible feedbacks will be used to control the output frequency of the adjustable frequency drive.
[0]	Sum	<i>Sum</i> [0] sets up the PID Controller to use the sum of Feedback 1, Feedback 2 and Feedback 3 as the feedback. NOTE! Any unused feedbacks must be set to <i>No Function</i> in <i>20-00 Feedback 1 Source</i> , <i>20-03 Feedback 2 Source</i> , or <i>20-06 Feedback 3 Source</i> . The sum of Setpoint 1 and any other references that are enabled (see parameter group 3-1*) will be used as the PID controller's setpoint reference.
[1]	Difference	<i>Difference</i> [1] sets up the PID controller to use the difference between Feedback 1 and Feedback 2 as the feedback. Feedback 3 will not be used with this selection. Only Setpoint 1 will be used. The sum of Setpoint 1 and any other references that are enabled (see parameter group 3-1*) will be used as the PID controller's setpoint reference.
[2]	Average	<i>Average</i> [2] sets up the PID Controller to use the average of Feedback 1, Feedback 2 and Feedback 3 as the feedback. NOTE! Any unused feedbacks must be set to <i>No Function</i> in <i>20-00 Feedback 1 Source</i> , <i>20-03 Feedback 2 Source</i> , or <i>20-06 Feedback 3 Source</i> . The sum of Setpoint 1 and any other references that are enabled (see parameter group 3-1*) will be used as the PID controller's setpoint reference.
[3]	Minimum	<i>Minimum</i> [3] sets up the PID controller to compare Feedback 1, Feedback 2 and Feedback 3 and use the lowest value as the feedback.

20-20 Feedback Function		
Option:	Function:	
		<p>NOTE!</p> <p>Any unused feedbacks must be set to <i>No Function</i> in <i>20-00 Feedback 1 Source</i>, <i>20-03 Feedback 2 Source</i>, or <i>20-06 Feedback 3 Source</i>. Only setpoint 1 will be used. The sum of Setpoint 1 and any other references that are enabled (see parameter group 3-1*) will be used as the PID controller's setpoint reference.</p>
[4]	Maximum	<p><i>Maximum</i> [4] sets up the PID controller to compare Feedback 1, Feedback 2 and Feedback 3 and use the highest value as the feedback.</p> <p>NOTE!</p> <p>Any unused feedbacks must be set to <i>No Function</i> in <i>20-00 Feedback 1 Source</i>, <i>20-03 Feedback 2 Source</i>, or <i>20-06 Feedback 3 Source</i>.</p> <p>Only Setpoint 1 will be used. The sum of Setpoint 1 and any other references that are enabled (see parameter group 3-1*) will be used as the PID controller's setpoint reference.</p>
[5]	Multi Setpoint Min	<p><i>Multi-setpoint minimum</i> [5] sets up the PID Controller to calculate the difference between Feedback 1 and Setpoint 1, Feedback 2 and Setpoint 2, and Feedback 3 and Setpoint 3. It will use the feedback/setpoint pair in which the feedback is the farthest below its corresponding setpoint reference. If all feedback signals are above their corresponding setpoints, the PID Controller will use the feedback/setpoint pair in which the difference between the feedback and setpoint is the least.</p> <p>NOTE!</p> <p>If only two feedback signals are used, the feedback that is not to be used must be set to <i>No Function</i> in <i>20-00 Feedback 1 Source</i>, <i>20-03 Feedback 2 Source</i> or <i>20-06 Feedback 3 Source</i>. Note that each setpoint reference will be the sum of its respective parameter value (<i>20-21 Setpoint 1</i>, <i>20-22 Setpoint 2</i> and <i>20-23 Setpoint 3</i>) and any other references that are enabled (see parameter group 3-1*).</p>
[6]	Multi Setpoint Max	<p><i>Multi-setpoint maximum</i> [6] sets up the PID Controller to calculate the difference between Feedback 1 and Setpoint 1, Feedback 2 and</p>

20-20 Feedback Function	
Option:	Function:
	<p>Setpoint 2, and Feedback 3 and Setpoint 3. It will use the feedback/setpoint pair in which the feedback is farthest above its corresponding setpoint reference. If all feedback signals are below their corresponding setpoints, the PID Controller will use the feedback/setpoint pair in which the difference between the feedback and the setpoint reference is the least.</p> <p>NOTE!</p> <p>If only two feedback signals are used, the feedback that is not to be used must be set to <i>No Function</i> in <i>20-00 Feedback 1 Source</i>, <i>20-03 Feedback 2 Source</i> or <i>20-06 Feedback 3 Source</i>. Note that each setpoint reference will be the sum of its respective parameter value (<i>20-21 Setpoint 1</i>, <i>20-22 Setpoint 2</i> and <i>20-23 Setpoint 3</i>) and any other references that are enabled (see parameter group 3-1*).</p>

NOTE!

Any unused feedback must be set to "No function" in its Feedback Source parameter: *20-00 Feedback 1 Source*, *20-03 Feedback 2 Source* or *20-06 Feedback 3 Source*.

The feedback resulting from the function selected in *20-20 Feedback Function* will be used by the PID controller to control the output frequency of the adjustable frequency drive. This feedback can also be shown on the adjustable frequency drive's display, be used to control an adjustable frequency drive's analog output, and be transmitted over various serial communication protocols.

The Adjustable frequency drive can be configured to handle multi-zone applications. Two different multi-zone applications are supported:

- Multi-zone, single setpoint
- Multi-zone, multi setpoint

The difference between the two is illustrated by the following examples:

Example 1: Multi-zone, single setpoint

In an office building, a VAV (variable air volume) VLT® HVAC Drive system must ensure a minimum pressure at selected VAV boxes. Due to the varying pressure losses in each duct, the pressure at each VAV box cannot be assumed to be the same. The minimum pressure required is the same for all VAV boxes. This control method can be set up by setting *20-20 Feedback Function* to option [3], Minimum, and entering the desired pressure in *20-21 Setpoint 1*. The PID controller will increase the speed of the fan if any one feedback is below the setpoint, and decrease the speed of the fan if all feedbacks are above the setpoint.

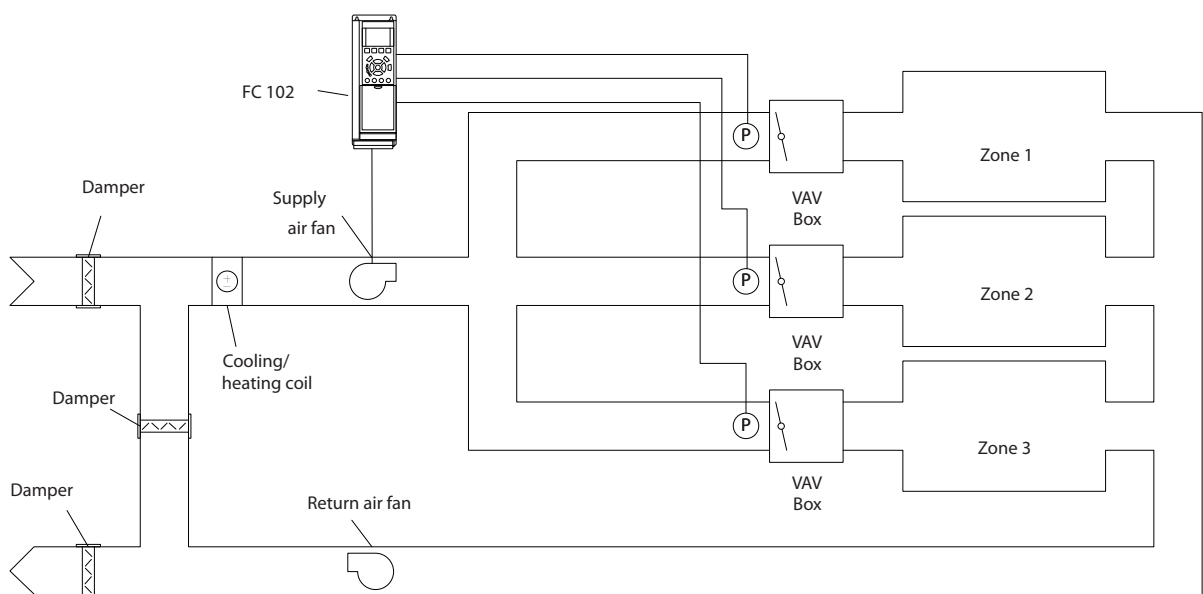

Figure 3.47

Example 2: Multi-zone, multi setpoint

The previous example can be used to illustrate the use of multi-zone, multi-setpoint control. If the zones require different pressures for each VAV box, each setpoint may be specified in *20-21 Setpoint 1*, *20-22 Setpoint 2* and *20-23 Setpoint 3*. By selecting *Multi-setpoint minimum*, [5], in *20-20 Feedback Function*, the PID controller will increase the speed of the fan if any one of the feedbacks is below its setpoint and decrease the speed of the fan if all feedbacks are above their individual setpoints.

20-21 Setpoint 1		
Range:	Function:	
0.000 ProcessCtrlUnit*	[par. 20-13 - par. 20-14 ProcessCtrlUnit]	Setpoint 1 is used in Closed-loop mode to enter a setpoint reference that is used by the adjustable frequency drive's PID controller. See the description of <i>20-20 Feedback Function</i> .

20-21 Setpoint 1		
Range:	Function:	
		NOTE! Setpoint reference entered here is added to any other references that are enabled (see parameter group 3-1*).

20-22 Setpoint 2		
Range:		Function:
0.000 ProcessCtrlUnit*	[par. 20-13 - par. 20-14 ProcessCtrlUnit]	Setpoint 2 is used in Closed-loop mode to enter a setpoint reference that may be used by the adjustable frequency drive's PID controller. See the description of <i>Feedback Function</i> , <i>20-20 Feedback Function</i> .

NOTE!

The setpoint reference entered here is added to any other references that are enabled (see parameter group 3-1*).

20-23 Setpoint 3		
Range:		Function:
0.000 ProcessCtrlUnit*	[par. 20-13 - par. 20-14 ProcessCtrlUnit]	Setpoint 3 is used in Closed-loop Mode to enter a setpoint reference that may be used by the adjustable frequency drive's PID Controller. See the description of <i>20-20 Feedback Function</i> .
		NOTE! The setpoint reference entered here is added to any other references that are enabled (see parameter group 3-1*).

3.18.3 20-3* Feedback Adv. Conversion

In air conditioning compressor applications it is often useful to control the system based on the temperature of the refrigerant. However, it is generally more convenient to directly measure its pressure. This parameter group allows the adjustable frequency drive's PID controller to convert refrigerant pressure measurements into temperature values.

20-30 Refrigerant		
Option:	Function:	
	Select the refrigerant used in the compressor application. This parameter must be specified correctly for the pressure to temperature conversion to be accurate. If the refrigerant used is not listed in choices [0] through [6], select <i>User defined</i> [7]. use <i>20-31 User-defined</i>	

20-30 Refrigerant		
Option:	Function:	
	Refrigerant A1, 20-32 <i>User-defined Refrigerant A2</i> and 20-33 <i>User-defined Refrigerant A3</i> to provide A1, A2 and A3 for the equation below: $\text{Temperature} = \frac{A2}{(\ln(Pe + 1) - A1)} - A3$	
[0] *	R22	
[1]	R134a	
[2]	R404a	
[3]	R407c	
[4]	R410a	
[5]	R502	
[6]	R744	
[7]	User-defined	

20-31 User-defined Refrigerant A1		
Range:		Function:
10.0000 *	[8.0000 - 12.0000]	Use this parameter to enter the value of coefficient A1 when <i>20-30 Refrigerant</i> is set to <i>User defined</i> [7].

20-32 User-defined Refrigerant A2		
Range:		Function:
-2250.00 *	[-3000.00 - -1500.00]	Use this parameter to enter the value of coefficient A2 when <i>20-30 Refrigerant</i> is set to <i>User-defined</i> [7].

20-33 User-defined Refrigerant A3		
Range:		Function:
250.000 *	[200.000 - 300.000]	Use this parameter to enter the value of coefficient A3 when <i>20-30 Refrigerant</i> is set to <i>User-defined</i> [7].

20-34 Duct 1 Area [m2]		
Range:	Function:	
0.500 m2*	[0.001 - 10.000 m2]	Used for setting the area of the air ducts in connection with feedback conversion pressure/velocity to flow. The unit (m ²) is determined by the setting of <i>0-03 Regional Settings</i> . Fan 1 is used with feedback 1. In case of flow difference control, set <i>20-20 Feedback Function</i> to [1] Difference, if flow fan 1 – flow fan 2 is to be controlled.

20-35 Fan 1 Area [in ²]		
Range:	Function:	
		Used for setting the area of the air ducts in connection with feedback conversion pressure/velocity to flow. The unit (in ²) is determined by the setting of <i>0-03 Regional Settings</i> . Fan 1 is used with feedback 1. In case of flow difference control, set <i>20-20 Feedback Function</i> to [1] Difference, if flow fan 1 – flow fan 2 is to be controlled.
750 in ^{2*}	[0–15000 in ²]	

20-36 Fan 2 Area [m ²]		
Range:	Function:	
		Used for setting the area of the air ducts in connection with feedback conversion pressure/velocity to flow. The unit (m ²) is determined by the setting of <i>0-03 Regional Settings</i> . Fan 2 is used with feedback 2. In case of flow difference control, set <i>20-20 Feedback Function</i> to [1] Difference, if flow fan 1 – flow fan 2 is to be controlled.
0.500 m ^{2*}	[0.000–10.000 m ²]	

20-37 Fan 2 Area [in ²]		
Range:	Function:	
		Used for setting the area of the air ducts in connection with feedback conversion pressure/velocity to flow. The unit (in ²) is determined by the setting of <i>0-03 Regional Settings</i> . Fan 2 is used with feedback 2. In case of flow difference control, set <i>20-20 Feedback Function</i> to [1] Difference, if flow fan 1 – flow fan 2 is to be controlled.
750 in ^{2*}	[0–15000 in ²]	

20-38 Air Density Factor [%]		
Range:	Function:	
100 %*	[50 - 150 %]	Set the air density factor for conversion from pressure to flow in % relative to the air density at sea level at 68°F [20°C] (100% ~ 1.2 kg/m ³).

3.18.4 20-6* Sensorless

Parameters for Sensorless. See also *20-00 Feedback 1 Source*, *18-50 Sensorless Readout [unit]*, *16-26 Power Filtered [kW]* and *16-27 Power Filtered [hp]*.

NOTE!

Sensorless unit and Sensorless Information requires set-up by MCT 10 Set-up Software with sensorless specific plug-in.

20-60 Sensorless Unit		
Option:	Function:	
		Select the unit to be used with <i>18-50 Sensorless Readout [unit]</i> .
[20]	liter / sec.	
[21]	liter / min	
[22]	liter / hr.	
[23]	m ³ / sec.	
[24]	m ³ /min	
[25]	m ³ / hr.	
[70]	mbar	
[71]	bar	
[72]	Pa	
[73]	kPa	
[74]	m WG	
[75]	mm Hg	
[120]	GPM	
[121]	gal / sec.	
[122]	gal/min	
[123]	gal / hr.	
[124]	CFM	
[125]	ft ³ /s	
[126]	ft ³ /min	
[127]	ft ³ /h	
[170]	psi	
[171]	lb/in ²	
[172]	in. wtr. gage	
[173]	ft WG	
[174]	in Hg	

20-69 Sensorless Information		
Range:	Function:	
0 *	[0 - 0]	View information about the sensor-less data.

3.18.5 20-7* PID autotuning

The adjustable frequency drive PID Closed-loop controller (parameter group 20-**, FC Drive Closed-loop) can be auto-tuned, simplifying and saving time during commissioning, while ensuring accurate PID control adjustment. To use auto-tuning, it is necessary for the Adjustable frequency drive to be configured for closed-loop in *1-00 Configuration Mode*.

A graphical local control panel (LCP) must be used in order to react on messages during the autotuning sequence.

3

Enabling *20-79 PID Autotuning* puts the Adjustable frequency drive into auto-tuning mode. The LCP then directs the user with on-screen instructions.

The fan/pump is started by pressing [Auto On] button on the LCP and applying a start signal. The speed is adjusted manually by pressing the [▲] or [▼] navigation keys on the LCP to a level where the feedback is around the system setpoint.

NOTE!

It is not possible to run the motor at maximum or minimum speed when manually adjusting the motor speed, due to the need to give the motor a step in the speed during autotuning.

PID autotuning functions by introducing step changes while operating at a steady state and then monitoring the feedback. From the feedback response, the required values for *20-93 PID Proportional Gain* and *20-94 PID Integral Time* are calculated. *20-95 PID Differentiation Time* is set to value 0 (zero). *20-81 PID Normal/ Inverse Control* is determined during the tuning process.

These calculated values are presented on the LCP and the user can decide whether to accept or reject them. Once accepted, the values are written to the relevant parameters and autotuning mode is disabled in *20-79 PID Autotuning*. Depending on the system being controlled, the time required to carry out autotuning could be several minutes. It is advised to set the ramp times in *3-41 Ramp 1 Ramp-up Time*, *3-42 Ramp 1 Ramp-down Time* or *3-51 Ramp 2 Ramp-up Time* and *3-52 Ramp 2 Ramp-down Time* according to the load inertia before carrying out PID autotuning. If PID autotuning is carried out with slow ramp times, the autotuned parameters will typically result in very slow control. Excessive feedback sensor noise should be removed using the input filter (parameter groups 6-**, 5-5* and 26-**, Terminal 53/54 Filter Time Constant/Pulse Filter Time Constant #29/33) before activating PID autotuning. In order to obtain the most accurate controller parameters, it is advised to carry out PID autotuning, when the application is running in typical operation, i.e. with a typical load.

20-70 Closed-loop Type	
Option:	Function:
	This parameter defines the application response. The default mode should be sufficient for most applications. If the application response speed is known, it can be selected here. This will decrease the time needed for carrying out PID

20-70 Closed-loop Type	
Option:	Function:
	autotuning. The setting has no impact on the value of the tuned parameters and is used only for the autotuning sequence.
[0] *	Auto
[1]	Fast Pressure
[2]	Slow Pressure
[3]	Fast Temperature
[4]	Slow Temperature

20-71 PID Performance	
Option:	Function:
[0] *	Normal Normal setting of this parameter will be suitable for pressure control in fan systems.
[1]	Fast Fast setting would generally be used in pumping systems, where a faster control response is desirable.

20-72 PID Output Change	
Range:	Function:
0.10 * [0.01 - 0.50]	This parameter sets the magnitude of step change during autotuning. The value is a percentage of full speed, i.e., if maximum output frequency in <i>4-13 Motor Speed High Limit [RPM]/4-14 Motor Speed High Limit [Hz]</i> is set to 50Hz, 0.10 is 10% of 50Hz, which is 5Hz. This parameter should be set to a value resulting in feedback changes of between 10% and 20% for best tuning accuracy.

20-73 Minimum Feedback Level	
Range:	Function:
-999999.000 ProcessCtrlUnit*	[-999999.999 - par. 20-74 ProcessCtrlUnit] The minimum allowable feedback level should be entered here in user units as defined in <i>20-12 Reference/Feedback Unit</i> . If the level falls below <i>20-73 Minimum Feedback Level</i> , autotuning is aborted and an error message will appear on the LCP.

20-74 Maximum Feedback Level		
Range:		Function:
999999.000 ProcessCtrlUnit*	[par. 20-73 - 999999.999 ProcessCtrlUnit]	The maximum allowable feedback level should be entered here in user units as defined in <i>20-12 Reference/Feedback Unit</i> . If the level rises above <i>20-74 Maximum Feedback Level</i> , autotuning is aborted and an error message will appear on the LCP.

20-79 PID Autotuning		
Option:	Function:	
		This parameter starts the PID autotuning sequence. Once the autotuning has successfully completed and the settings have been accepted or rejected by the user, by pressing [OK] or [Cancel] buttons on the LCP at the end of tuning, this parameter is reset to [0] Disabled.
[0] *	Disabled	
[1]	Enabled	

3.18.6 20-8* PID Basic Settings

This parameter group is used to configure the basic operation of the adjustable frequency drive's PID controller, including how it responds to a feedback that is above or below the setpoint, the speed at which it first starts functioning, and when it will indicate that the system has reached the setpoint.

20-81 PID Normal/ Inverse Control		
Option:	Function:	
[0] *	Normal	<i>Normal</i> [0] causes the adjustable frequency drive's output frequency to decrease when the feedback is greater than the setpoint reference. This is common for pressure-controlled supply fan and pump applications.
[1]	Inverse	<i>Inverse</i> [1] causes the adjustable frequency drive's output frequency to increase when the feedback is greater than the setpoint reference. This is common for temperature-controlled cooling applications, such as cooling towers.

20-82 PID Start Speed [RPM]		
Range:		Function:
Size related*	[0 - par. 4-13 RPM]	When the Adjustable frequency drive is first started, it initially ramps up to this output speed in open-loop mode, following the

20-82 PID Start Speed [RPM]		
Range:		Function:
		active Ramp-up Time. When the output speed programmed here is reached, the Adjustable frequency drive will automatically switch to closed-loop mode and the PID controller will begin to function. This is useful in applications in which the driven load must first quickly accelerate to a minimum speed when it is started. NOTE! This parameter will only be visible if <i>0-02 Motor Speed Unit</i> is set to [0], RPM.

20-83 PID Start Speed [Hz]		
Range:		Function:
Size related*	[0.0 - par. 4-14 Hz]	When the Adjustable frequency drive is first started, it initially ramps up to this output frequency in open-loop mode, following the active Ramp-up Time. When the output frequency programmed here is reached, the Adjustable frequency drive will automatically switch to Closed-loop mode and the PID controller will begin to function. This is useful in applications in which the driven load must first quickly accelerate to a minimum speed when it is started. NOTE! This parameter will only be visible if <i>0-02 Motor Speed Unit</i> is set to [1], Hz.

20-84 On Reference Bandwidth		
Range:		Function:
5 %*	[0 - 200 %]	

3.18.7 20-9* PID Controller

This group provides the ability to manually adjust this PID Controller. By adjusting the PID Controller parameters the control performance may be improved. See section *PID* in the VLT® HVAC Drive Design Guide, *MG.11.BX.YY* for guidelines on adjusting the PID controller parameters.

20-91 PID Anti Windup		
Option:	Function:	
[0]	Off	<i>Off</i> [0] The integrator will continue to change value also after output has reached one of the extremes. This can afterwards cause a delay of change of the output of the controller.
[1] *	On	<i>On</i> [1] The integrator will be locked if the output of the built-in PID controller has reached one of the extremes (min or max value) and therefore not able to add further change to the value of the process parameter controlled. This allows the controller to respond more quickly when it again can control the system.

20-93 PID Proportional Gain		
Range:	Function:	
0.50 *	[0.00 - 10.00]	The proportional gain indicates the number of times the error between the setpoint and the feedback signal is to be applied.

If (Error x Gain) jumps with a value equal to what is set in *20-14 Maximum Reference/Feedb.*, the PID controller will try to change the output speed equal to what is set in *4-13 Motor Speed High Limit [RPM]/4-14 Motor Speed High Limit [Hz]* but in practice of course limited by this setting. The proportional band (error causing output to change from 0–100%) can be calculated by means of the formula:

$$\left(\frac{1}{\text{Proportional Gain}} \right) \times (\text{Max Reference})$$

NOTE!

Always set the desired for *20-14 Maximum Reference/Feedb.* before setting the values for the PID controller in parameter group 20-9*.

20-94 PID Integral Time		
Range:	Function:	
20.00 s*	[0.01 - 10000.00 s]	Over time, the integrator accumulates a contribution to the output from the PID controller as long as there is a deviation between the reference/setpoint and feedback signals. The contribution is proportional to the size of the deviation. This ensures that the deviation (error) approaches zero. Quick response on any deviation is obtained when the integral time is set to a low value. Setting it too low, however, may cause the control to become unstable. The value set is the time needed for the integrator to add the same contribution as the proportional for a certain deviation.

20-94 PID Integral Time		
Range:	Function:	
		If the value is set to 10,000, the controller will act as a pure proportional controller with a P-band based on the value set in <i>20-93 PID Proportional Gain</i> . When no deviation is present, the output from the proportional controller will be 0.

20-95 PID Differentiation Time		
Range:	Function:	
0.00 s*	[0.00 - 10.00 s]	The differentiator monitors the rate of change of the feedback. If the feedback is changing quickly, it will adjust the output of the PID Controller to reduce the rate of change of the feedback. Quick PID Controller response is obtained when this value is large. However, if a value that is too large is used, the adjustable frequency drive's output frequency may become unstable. Differentiation time is useful in situations where extremely fast adjustable frequency drive response and precise speed control are required. It can be difficult to adjust this for proper system control. Differentiation time is not commonly used in VLT [®] HVAC Drive applications. Therefore, it is generally best to leave this parameter at 0 or OFF.

20-96 PID Diff. Gain Limit		
Range:	Function:	
5.0 *	[1.0 - 50.0]	The differential function of a PID Controller responds to the rate of change of the feedback. As a result, an abrupt change in the feedback can cause the differential function to make a very large change in the PID Controller's output. This parameter limits the maximum effect that the PID Controller's differential function can produce. A smaller value reduces the maximum effect of the PID Controller's differential function. This parameter is only active when <i>20-95 PID Differentiation Time</i> is not set to OFF (0 s).

3.19 Main Menu - Extended Closed-loop - Group 21

The FC 102 offers 3 extended closed-loop PID controllers in addition to the PID controller. These can be configured independently to control either external servos (valves, dampers, etc.) or be used together with the internal PID controller to improve the dynamic responses to setpoint changes or load disturbances.

The extended closed-loop PID controllers may be interconnected or connected to the PID closed-loop controller to form a dual loop configuration.

In order to control a modulating device (e.g., a valve motor), this device must be a positioning servo motor with built-in electronics accepting either a 0–10 V (signal from Analog I/O card MCB 109) or a 0/4–20 mA (signal from control card and/or General Purpose I/O card MCB 101) control signal.

The output function can be programmed in the following parameters:

- Control Card, terminal 42: *6-50 Terminal 42 Output* (setting [113]...[115] or [149]...[151], Ext. Closed-loop 1/2/3
- General Purpose I/O card MCB 101, terminal X30/8: *6-60 Terminal X30/8 Output*, (setting [113]...[115] or [149]...[151], Ext. Closed-loop 1/2/3
- Analog I/O card MCB 109, terminal X42/7...11: *26-40 Terminal X42/7 Output, 26-50 Terminal X42/9 Output, 26-60 Terminal X42/11 Output* (setting [113]...[115], Ext. Closed-loop 1/2/3

General Purpose I/O card and Analog I/O card are optional cards.

3.19.1 21-0* Extended CL autotuning

The extended PID Closed-loop PID controllers can each be auto-tuned, simplifying and saving time during commissioning, while ensuring accurate PID control adjustment.

To use PID autotuning it is necessary for the relevant extended PID controller to have been configured for the application.

A graphical Local Control Panel (LCP) must be used in order to react on messages during the autotuning sequence.

Enabling autotuning *21-09 PID Autotuning* puts the relevant PID controller into PID autotuning mode. The LCP then directs the user with on-screen instructions.

PID autotuning functions by introducing step changes and then monitoring the feedback. From the feedback response, the required values for PID Proportional Gain, *21-21 Ext. 1 Proportional Gain* for EXT CL 1, *21-41 Ext. 2 Proportional Gain* for EXT CL 2 and *21-61 Ext. 3 Proportional Gain* for EXT CL 3 and Integral Time, *21-22 Ext. 1 Integral Time* for EXT CL 1, *21-42 Ext. 2 Integral Time* for EXT CL 2 and *21-62 Ext. 3 Integral Time* for EXT CL 3 are calculated. PID Differentiation Time, *21-23 Ext. 1 Differentiation Time* for EXT CL 1, *21-43 Ext. 2 Differentiation Time* for EXT CL 2 and *21-63 Ext. 3 Differentiation Time* for EXT CL 3 are set to value 0 (zero). Normal / Inverse, *21-20 Ext. 1 Normal/Inverse Control* for EXT CL 1, *21-40 Ext. 2 Normal/Inverse Control* for EXT CL 2 and *21-60 Ext. 3 Normal/Inverse Control* for EXT CL 3 are determined during the tuning process.

These calculated values are presented on the LCP and the user can decide whether to accept or reject them. Once accepted, the values are written to the relevant parameters and PID autotuning mode is disabled in *21-09 PID Autotuning*. Depending on the system being controlled the time required to carry out PID autotuning could be several minutes.

Excessive feedback sensor noise should be removed using the input filter (parameter groups 5-5*, 6-**, and 26-**, Terminal 53/54 Filter Time Constant/Pulse Filter Time Constant #29/33) before activating PID autotuning.

21-00 Closed-loop Type		Function:
Option:		
[0] *	Auto	This parameter defines the application response. The default mode should be sufficient for most applications. If the relative application speed is known, it can be selected here. This will decrease the time needed for carrying out PID autotuning. The setting has no impact on the value of the tuned parameters and is used only for the PID autotuning sequence.
[1]	Fast Pressure	
[2]	Slow Pressure	
[3]	Fast Temperature	
[4]	Slow Temperature	

21-01 PID Performance		
Option:	Function:	
[0]	Normal	Normal setting of this parameter will be suitable for pressure control in fan systems.
[1]	Fast	Fast setting would generally be used in pumping systems, where a faster control response is desirable.

21-02 PID Output Change		
Range:	Function:	
0.10 * [0.01 - 0.50]	This parameter sets the magnitude of step change during autotuning. The value is a percentage of full operating range. This means that if maximum analog output voltage is set to 10 V, 0.10 is 10% of 10 V, which is 1 V. This parameter should be set to a value resulting in feedback changes of between 10% and 20% for best tuning accuracy.	

21-03 Minimum Feedback Level		
Range:	Function:	
-999999.000 * [-999999.999 - par. 21-04]	The minimum allowable feedback level should be entered here in user units as defined in 21-10 Ext. 1 Ref./Feedback Unit for EXT CL 1, 21-30 Ext. 2 Ref./Feedback Unit for EXT CL 2 or 21-50 Ext. 3 Ref./Feedback Unit for EXT CL 3. If the level falls below 21-03 Minimum Feedback Level, PID autotuning is aborted and an error message will appear on the LCP.	

21-04 Maximum Feedback Level		
Range:	Function:	
999999.000 * [par. 21-03 - 999999.999]	The maximum allowable feedback level should be entered here in user units as defined in 21-10 Ext. 1 Ref./Feedback Unit for EXT CL 1, 21-30 Ext. 2 Ref./Feedback Unit for EXT CL 2 or 21-50 Ext. 3 Ref./Feedback Unit for EXT CL 3. If the level rises above 21-04 Maximum Feedback Level, PID autotuning is aborted and an error message will appear on the LCP.	

21-09 PID Autotuning		
Option:	Function:	
	This parameter enables selection of the extended PID controller to be autotuned and starts the PID autotuning for that controller. Once the autotuning has	

21-09 PID Autotuning		
Option:	Function:	
	successfully completed and the settings have been accepted or rejected by the user, by pressing [OK] or [Cancel] buttons on the LCP at the end of tuning, this parameter is reset to [0] Disabled.	
[0] *	Disabled	
[1]	Enabled Ext CL 1 PID	
[2]	Enabled Ext CL 2 PID	
[3]	Enabled Ext CL 3 PID	

3.19.2 21-1* Closed-loop 1 Ref/Feedback

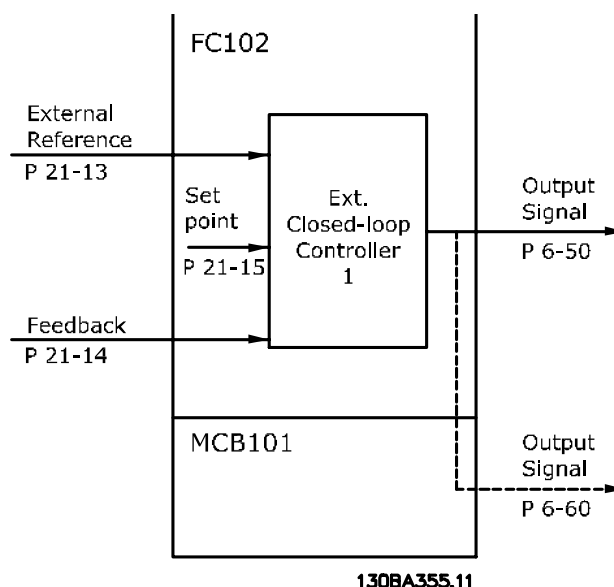

Figure 3.48

21-10 Ext. 1 Ref./Feedback Unit		
Option:	Function:	
	Select the unit for the reference and feedback.	
[0]		
[1] *	%	
[5]	PPM	
[10]	min	
[11]	RPM	
[12]	PULSE/s	
[20]	liter / sec.	
[21]	liter / min	

21-10 Ext. 1 Ref./Feedback Unit	
Option:	Function:
[22]	liter / hr.
[23]	m ³ / sec.
[24]	m ³ /min
[25]	m ³ / hr.
[30]	kg / sec.
[31]	kg/min
[32]	kg / hr.
[33]	ton / min
[34]	ton / hr.
[40]	m / sec.
[41]	m/min
[45]	m
[60]	°C
[70]	mbar
[71]	bar
[72]	Pa
[73]	kPa
[74]	m WG
[75]	mm Hg
[80]	kW
[120]	GPM
[121]	gal / sec.
[122]	gal/min
[123]	gal / hr.
[124]	CFM
[125]	ft ³ /s
[126]	ft ³ /min
[127]	ft ³ /h
[130]	lbs / sec.
[131]	lbs / min.
[132]	lbs / hr.
[140]	ft/s
[141]	ft/min
[145]	ft
[160]	°F
[170]	psi
[171]	lb/in ²
[172]	in. wtr. gage
[173]	ft WG
[174]	in Hg
[180]	HP

21-11 Ext. 1 Minimum Reference	
Range:	Function:
0.000 ExtPID1Unit*	[-999999.999 - par. 21-12 ExtPID1Unit] Select the minimum for the closed-loop 1 controller.

21-12 Ext. 1 Maximum Reference	
Range:	Function:
100.000 ExtPID1Unit*	[par. 21-11 - 999999.999 ExtPID1Unit] Select the maximum for the Closed-Loop 1 Controller. The dynamics of the PID controller will depend on the value set in this parameter. Please see also 21-21 Ext. 1 Proportional Gain.

NOTE!

Always set the desired value for 21-12 Ext. 1 Maximum Reference before setting the values for the PID controller in parameter group 20-9*.

21-13 Ext. 1 Reference Source	
Option:	Function:
	This parameter defines which input on the Adjustable frequency drive should be treated as the source of the reference signal for the Closed-Loop 1 Controller. Analog input X30/11 and Analog input X30/12 refer to inputs on the General Purpose I/O.
[0] *	No function
[1]	Analog input 53
[2]	Analog input 54
[7]	Pulse input 29
[8]	Pulse input 33
[20]	Digital pot.meter
[21]	Analog input X30/11
[22]	Analog input X30/12
[23]	Analog Input X42/1
[24]	Analog Input X42/3
[25]	Analog Input X42/5
[29]	Analog Input X48/2
[30]	Ext. Closed-loop 1
[31]	Ext. Closed-loop 2
[32]	Ext. Closed-loop 3

21-14 Ext. 1 Feedback Source		
Option:	Function:	
		This parameter defines which input on the Adjustable frequency drive should be treated as the source of the feedback signal for the Closed-Loop 1 controller. Analog input X30/11 and Analog input X30/12 refer to inputs on the General Purpose I/O.
[0] *	No function	
[1]	Analog input 53	
[2]	Analog input 54	
[3]	Pulse input 29	
[4]	Pulse input 33	
[7]	Analog input X30/11	
[8]	Analog input X30/12	
[9]	Analog Input X42/1	
[10]	Analog Input X42/3	
[11]	Analog Input X42/5	
[15]	Analog Input X48/2	
[100]	Bus feedback 1	
[101]	Bus feedback 2	
[102]	Bus feedback 3	

21-15 Ext. 1 Setpoint		
Range:	Function:	
0.000 ExtPID1Unit*	[par. 21-11 - par. 21-12 ExtPID1Unit]	The setpoint reference is used in extended 1 closed-loop. Ext.1 Setpoint is added to the value from the Ext.1 Reference source selected in 21-13 Ext. 1 Reference Source.

21-17 Ext. 1 Reference [Unit]		
Range:	Function:	
0.000 ExtPID1Unit*	[-999999.999 - 999999.999 ExtPID1Unit]	Readout of the reference value for the closed-loop 1 controller.

21-18 Ext. 1 Feedback [Unit]		
Range:	Function:	
0.000 ExtPID1Unit*	[-999999.999 - 999999.999 ExtPID1Unit]	Readout of the feedback value for the closed-loop 1 controller.

21-19 Ext. 1 Output [%]		
Range:	Function:	
0 %*	[0 - 100 %]	Readout of the output value for the closed-loop 1 controller.

3.19.3 21-2* Closed-loop 1 PID

21-20 Ext. 1 Normal/Inverse Control		
Option:	Function:	
[0]	Normal	Select <i>Normal</i> [0] if the output should be reduced when feedback is higher than the reference.
[1]	Inverse	Select <i>Inverse</i> [1] if the output should be increased when feedback is higher than the reference.

21-21 Ext. 1 Proportional Gain		
Range:	Function:	
0.01 *	[0.00 - 10.00]	The proportional gain indicates the number of times the error between the setpoint and the feedback signal is to be applied.

If (Error x Gain) jumps with a value equal to what is set in 20-14 *Maximum Reference/Feedb.*, the PID controller will try to change the output speed equal to what is set in 4-13 *Motor Speed High Limit [RPM]*/4-14 *Motor Speed High Limit [Hz]* but in practice of course limited by this setting. The proportional band (error causing output to change from 0–100%) can be calculated by means of the formula:

$$\left(\frac{1}{\text{Proportional Gain}} \right) \times (\text{Max Reference})$$

NOTE!

Always set the desired for 20-14 Maximum Reference/Feedb. before setting the values for the PID controller in parameter group 20-9*.

21-22 Ext. 1 Integral Time		
Range:	Function:	
10000.00 s* [0.01 - 10000.00 s]	Over time, the integrator accumulates a contribution to the output from the PID controller as long as there is a deviation between the reference/setpoint and feedback signals. The contribution is proportional to the size of the deviation. This ensures that the deviation (error) approaches zero. Quick response on any deviation is obtained when the integral time is set to a low value. Setting it too low, however, may cause the control to become unstable. The value set is the time needed for the integrator to add the same contribution as the proportional part for a certain deviation. If the value is set to 10,000, the controller will act as a pure proportional controller with a P-band based on the value set in 20-93 PID Proportional Gain. When no deviation is present, the output from the proportional controller will be 0.	

21-23 Ext. 1 Differentiation Time		
Range:	Function:	
0.00 s* [0.00 - 10.00 s]	The differentiator does not react to a constant error. It only provides a gain when the feedback changes. The quicker the feedback changes, the stronger the gain from the differentiator.	

21-24 Ext. 1 Dif. Gain Limit		
Range:	Function:	
5.0 * [1.0 - 50.0]	Set a limit for the differentiator gain (DG). The DG will increase if there are fast changes. Limit the DG to obtain a pure differentiator gain at slow changes and a constant differentiator gain where quick changes occur.	

3.19.4 21-3* Closed-loop 2 Ref./Fb.

21-30 Ext. 2 Ref./Feedback Unit		
Option:	Function:	
	See 21-10 Ext. 1 Ref./Feedback Unit for details	
[0]		
[1] *	%	
[5]	PPM	
[10]	min	
[11]	RPM	
[12]	PULSE/s	
[20]	liter / sec.	
[21]	liter / min	
[22]	liter / hr.	
[23]	m ³ / sec.	
[24]	m ³ /min	
[25]	m ³ / hr.	
[30]	kg / sec.	
[31]	kg/min	
[32]	kg / hr.	
[33]	ton / min	
[34]	ton / hr.	
[40]	m / sec.	
[41]	m/min	
[45]	m	
[60]	°C	
[70]	mbar	
[71]	bar	
[72]	Pa	
[73]	kPa	
[74]	m WG	
[75]	mm Hg	
[80]	kW	
[120]	GPM	
[121]	gal / sec.	
[122]	gal/min	
[123]	gal / hr.	
[124]	CFM	
[125]	ft ³ /s	
[126]	ft ³ /min	
[127]	ft ³ /h	
[130]	lbs / sec.	
[131]	lbs / min.	
[132]	lbs / hr.	
[140]	ft/s	
[141]	ft/min	
[145]	ft	
[160]	°F	
[170]	psi	
[171]	lb/in ²	
[172]	in. wtr. gage	

21-30 Ext. 2 Ref./Feedback Unit		
Option:	Function:	
[173]	ft WG	
[174]	in Hg	
[180]	HP	

21-31 Ext. 2 Minimum Reference		
Range:	Function:	
0.000 ExtPID2Unit*	[-999999.999 - par. 21-32 ExtPID2Unit]	See 21-11 Ext. 1 <i>Minimum Reference</i> for details.

21-32 Ext. 2 Maximum Reference		
Range:	Function:	
100.000 ExtPID2Unit*	[par. 21-31 - 999999.999 ExtPID2Unit]	See 21-12 Ext. 1 <i>Maximum Reference</i> for details.

21-33 Ext. 2 Reference Source		
Option:	Function:	
		See 21-13 Ext. 1 <i>Reference Source</i> for details.
[0] *	No function	
[1]	Analog input 53	
[2]	Analog input 54	
[7]	Pulse input 29	
[8]	Pulse input 33	
[20]	Digital pot.meter	
[21]	Analog input X30/11	
[22]	Analog input X30/12	
[23]	Analog Input X42/1	
[24]	Analog Input X42/3	
[25]	Analog Input X42/5	
[29]	Analog Input X48/2	
[30]	Ext. Closed-loop 1	
[31]	Ext. Closed-loop 2	
[32]	Ext. Closed-loop 3	

21-34 Ext. 2 Feedback Source		
Option:	Function:	
		See 21-14 Ext. 1 <i>Feedback Source</i> for details.
[0] *	No function	
[1]	Analog input 53	
[2]	Analog input 54	
[3]	Pulse input 29	
[4]	Pulse input 33	
[7]	Analog input X30/11	
[8]	Analog input X30/12	
[9]	Analog Input X42/1	
[10]	Analog Input X42/3	

21-34 Ext. 2 Feedback Source		
Option:	Function:	
[11]	Analog Input X42/5	
[15]	Analog Input X48/2	
[100]	Bus feedback 1	
[101]	Bus feedback 2	
[102]	Bus feedback 3	

21-35 Ext. 2 Setpoint		
Range:	Function:	
0.000 ExtPID2Unit*	[par. 21-31 - par. 21-32 ExtPID2Unit]	See 21-15 Ext. 1 <i>Setpoint</i> for details.

21-37 Ext. 2 Reference [Unit]		
Range:	Function:	
0.000 ExtPID2Unit*	[-999999.999 - 999999.999 ExtPID2Unit]	See 21-17 Ext. 1 <i>Reference [Unit]</i> , Ext. 1 <i>Reference [Unit]</i> , for details.

21-38 Ext. 2 Feedback [Unit]		
Range:	Function:	
0.000 ExtPID2Unit*	[-999999.999 - 999999.999 ExtPID2Unit]	See 21-18 Ext. 1 <i>Feedback [Unit]</i> for details.

21-39 Ext. 2 Output [%]		
Range:	Function:	
0 %*	[0 - 100 %]	See 21-19 Ext. 1 <i>Output [%]</i> for details.

3.19.5 21-4* Closed-loop 2 PID

21-40 Ext. 2 Normal/Inverse Control		
Option:	Function:	
		See 21-20 Ext. 1 <i>Normal/Inverse Control</i> for details.
[0]	Normal	
[1]	Inverse	

21-41 Ext. 2 Proportional Gain		
Range:	Function:	
0.01 *	[0.00 - 10.00]	See 21-21 Ext. 1 <i>Proportional Gain</i> for details.

21-42 Ext. 2 Integral Time		
Range:	Function:	
10000.00 s*	[0.01 - 10000.00 s]	See 21-22 Ext. 1 <i>Integral Time</i> for details.

21-43 Ext. 2 Differentiation Time		
Range:	Function:	
0.00 s* [0.00 - 10.00 s]	See 21-23 Ext. 1 Differentiation Time for details.	

21-44 Ext. 2 Dif. Gain Limit		
Range:	Function:	
5.0 * [1.0 - 50.0]	See 21-24 Ext. 1 Dif. Gain Limit for details.	

3.19.6 21-5* Closed-loop 3 Ref/Fb

21-50 Ext. 3 Ref./Feedback Unit		
Option:	Function:	
	See 21-10 Ext. 1 Ref./Feedback Unit for details.	
[0]		
[1] *	%	
[5]	PPM	
[10]	min	
[11]	RPM	
[12]	PULSE/s	
[20]	liter / sec.	
[21]	liter / min	
[22]	liter / hr.	
[23]	m ³ / sec.	
[24]	m ³ /min	
[25]	m ³ / hr.	
[30]	kg / sec.	
[31]	kg/min	
[32]	kg / hr.	
[33]	ton / min	
[34]	ton / hr.	
[40]	m / sec.	
[41]	m/min	
[45]	m	
[60]	°C	
[70]	mbar	
[71]	bar	
[72]	Pa	
[73]	kPa	
[74]	m WG	
[75]	mm Hg	
[80]	kW	
[120]	GPM	
[121]	gal / sec.	
[122]	gal/min	
[123]	gal / hr.	
[124]	CFM	
[125]	ft ³ /s	
[126]	ft ³ /min	
[127]	ft ³ /h	

21-50 Ext. 3 Ref./Feedback Unit		
Option:	Function:	
[130]	lbs / sec.	
[131]	lbs / min.	
[132]	lbs / hr.	
[140]	ft/s	
[141]	ft/min	
[145]	ft	
[160]	°F	
[170]	psi	
[171]	lb/in ²	
[172]	in. wtr. gage	
[173]	ft WG	
[174]	in Hg	
[180]	HP	

21-51 Ext. 3 Minimum Reference		
Range:	Function:	
0.000 ExtPID3Unit*	[-999999.999 - par. 21-52 ExtPID3Unit]	See 21-11 Ext. 1 Minimum Reference for details.

21-52 Ext. 3 Maximum Reference		
Range:	Function:	
100.000 ExtPID3Unit*	[par. 21-51 - 999999.999 ExtPID3Unit]	See 21-12 Ext. 1 Maximum Reference for details.

21-53 Ext. 3 Reference Source		
Option:	Function:	
	See 21-13 Ext. 1 Reference Source for details.	
[0] *	No function	
[1]	Analog input 53	
[2]	Analog input 54	
[7]	Pulse input 29	
[8]	Pulse input 33	
[20]	Digital pot.meter	
[21]	Analog input X30/11	
[22]	Analog input X30/12	
[23]	Analog Input X42/1	
[24]	Analog Input X42/3	
[25]	Analog Input X42/5	
[29]	Analog Input X48/2	
[30]	Ext. Closed-loop 1	
[31]	Ext. Closed-loop 2	
[32]	Ext. Closed-loop 3	

21-54 Ext. 3 Feedback Source		
Option:	Function:	
		See 21-14 Ext. 1 Feedback Source for details.
[0] *	No function	
[1]	Analog input 53	
[2]	Analog input 54	
[3]	Pulse input 29	
[4]	Pulse input 33	
[7]	Analog input X30/11	
[8]	Analog input X30/12	
[9]	Analog Input X42/1	
[10]	Analog Input X42/3	
[11]	Analog Input X42/5	
[15]	Analog Input X48/2	
[100]	Bus feedback 1	
[101]	Bus feedback 2	
[102]	Bus feedback 3	

21-55 Ext. 3 Setpoint		
Range:	Function:	
0.000 ExtPID3Unit*	[par. 21-51 - par. 21-52 ExtPID3Unit]	See 21-15 Ext. 1 Setpoint for details.

21-57 Ext. 3 Reference [Unit]		
Range:	Function:	
0.000 ExtPID3Unit*	[-999999.999 - 999999.999 ExtPID3Unit]	See 21-17 Ext. 1 Reference [Unit] for details.

21-58 Ext. 3 Feedback [Unit]		
Range:	Function:	
0.000 ExtPID3Unit*	[-999999.999 - 999999.999 ExtPID3Unit]	See 21-18 Ext. 1 Feedback [Unit] for details.

21-59 Ext. 3 Output [%]		
Range:	Function:	
0 %*	[0 - 100 %]	

3.19.7 21-6* Closed-loop 3 PID

21-60 Ext. 3 Normal/Inverse Control		
Option:	Function:	
		See 21-20 Ext. 1 Normal/Inverse Control for details.
[0]	Normal	
[1]	Inverse	

21-61 Ext. 3 Proportional Gain		
Range:	Function:	
0.01 *	[0.00 - 10.00]	See 21-21 Ext. 1 Proportional Gain for details.

21-62 Ext. 3 Integral Time		
Range:	Function:	
10000.00 s*	[0.01 - 10000.00 s]	See 21-22 Ext. 1 Integral Time for details.

21-63 Ext. 3 Differentiation Time		
Range:	Function:	
0.00 s*	[0.00 - 10.00 s]	See 21-23 Ext. 1 Differentiation Time for details.

21-64 Ext. 3 Dif. Gain Limit		
Range:	Function:	
5.0 *	[1.0 - 50.0]	See 21-24 Ext. 1 Dif. Gain Limit for details.

3.20 Main Menu - Appl. Functions - Group 22

This group contains parameters used for monitoring VLT® HVAC Drive applications.

22-00 External Interlock Delay		
Range:	Function:	
0 s* [0 - 600 s]	Only relevant if one of the digital inputs in parameter group 5-1* has been programmed for <i>External Interlock</i> [7]. The external interlock timer will introduce a delay after the signal has been	

22-00 External Interlock Delay		
Range:	Function:	
	removed from the digital input programmed for External Interlock, before a reaction takes place.	

3

22-01 Power Filter Time		
Range:	Function:	
0.50 s* [0.02 - 10.00 s]	Sets the time constant for the filtered power readout. A higher value will give a more steady readout but a slower system response to changes.	

3.20.1 22-2* No-Flow Detection

130BA252.14

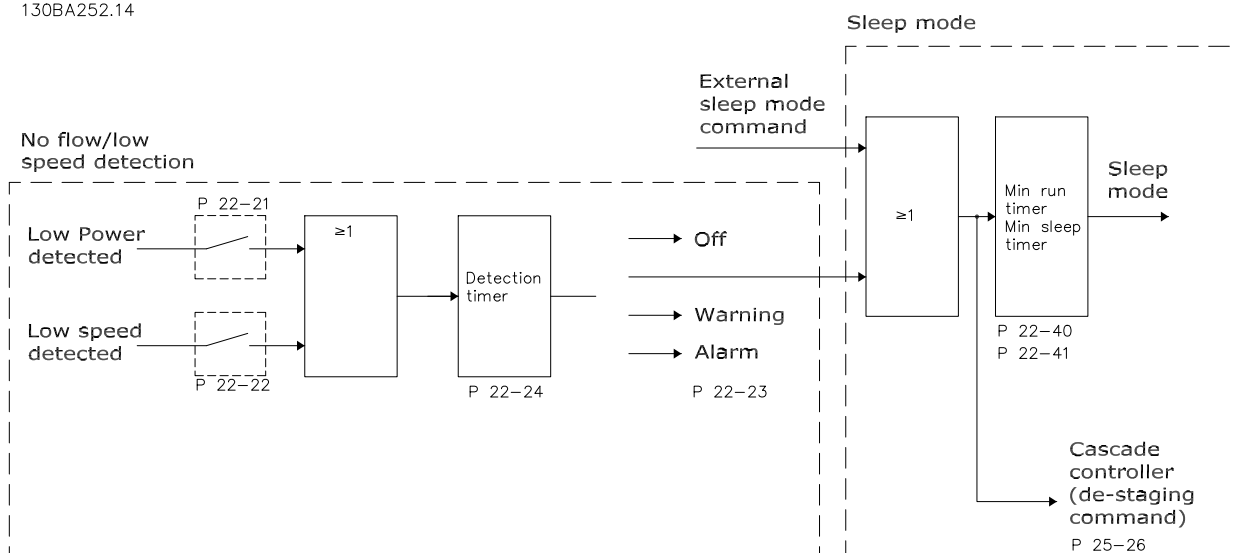

Figure 3.49

The Adjustable frequency drive includes functions for detecting if the load conditions in the system allow the motor to be stopped:

- *Low Power Detection
- *Low Speed Detection

One of these two signals must be active for a set time (22-24 *No-Flow Delay*) before selected action takes place. Possible actions to select (22-23 *No-Flow Function*): No action, Warning, Alarm, Sleep Mode.

No-Flow Detection:

This function is used for detecting a no-flow situation in pump systems where all valves can be closed. Can be used both when controlled by the integrated PI controller in the Adjustable frequency drive or an external PI controller. The actual configuration must be programmed in 1-00 *Configuration Mode*.

Configuration mode for

- Integrated PI Controller: Closed-Loop
- External PI Controller: Open-Loop

NOTE!

Carry out No-Flow tuning before setting the PI controller parameters!

3

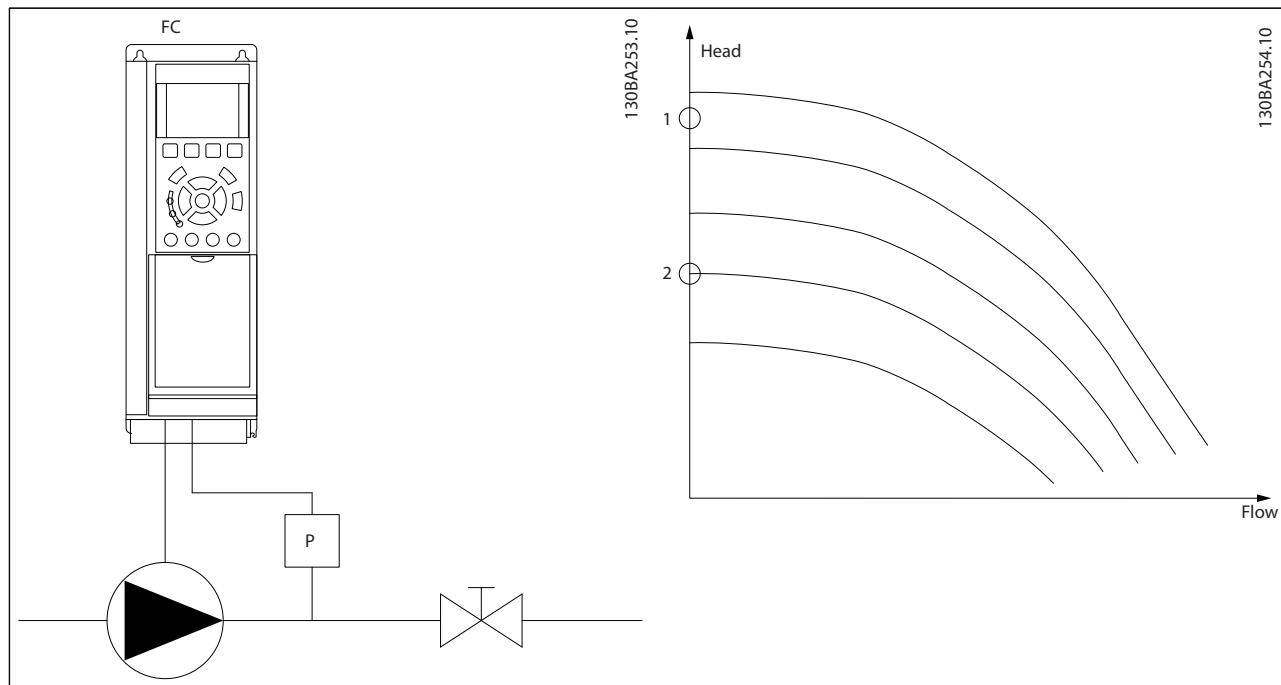

Table 3.28

No-Flow Detection is based on the measurement of speed and power. For a certain speed, the Adjustable frequency drive calculates the power at no-flow.

This coherence is based on the adjustment of two sets of speed and associated power at no-flow. By monitoring the power, it is possible to detect no-flow conditions in systems with fluctuating suction pressure, or if the pump has a flat characteristic towards low speed.

The two sets of data must be based on measurement of power at approximately 50% and 85% of maximum speed with the valve(s) closed. The data are programmed in the parameter group 22-3*. It is also possible to run a Low Power Auto Set-up (22-20 Low Power Auto Set-up) automatically stepping through the commissioning process and also automatically storing the data measured. The Adjustable frequency drive must be set for Open-loop in 1-00 Configuration Mode, when carrying out the Auto Set-up (See No-Flow Tuning parameter group 22-3*).

NOTE!

If using the integrated PI controller, carry out No-Flow tuning before setting the PI controller parameters!

Low speed detection:

Low Speed Detection gives a signal if the motor is operating with minimum speed as set in 4-11 Motor Speed Low Limit [RPM] or 4-12 Motor Speed Low Limit [Hz]. Actions are common with No-Flow Detection (individual selection not possible).

The use of Low Speed Detection is not limited to systems with a no-flow situation, but can be used in any system where operation at minimum speed allows for a stop of the motor until the load calls for a speed higher than minimum speed, e.g., systems with fans and compressors.

NOTE!

In pump systems, ensure that the minimum speed in 4-11 Motor Speed Low Limit [RPM] or 4-12 Motor Speed Low Limit [Hz] has been set high enough for detection as the pump can run with a rather high speed even with valves closed.

Dry pump detection:

No-Flow Detection can also be used for detecting if the pump has run dry (low power consumption-high speed). Can be used with both the integrated PI controller and an external PI controller.

The condition for Dry Pump signal:

- Power consumption below no-flow level

and

- Pump running at maximum speed or maximum reference open-loop, whichever is lowest.

The signal must be active for a set time (22-27 Dry Pump Delay) before selected action takes place.

Possible Actions to select (22-26 Dry Pump Function):

- Warning
- Alarm

No-Flow Detection must be enabled (22-23 No-Flow Function) and commissioned (parameter group 22-3*, No Power Tuning).

22-20 Low Power Auto Set-up		
Start of auto set-up of power data for No-Flow Power tuning.		
Option:	Function:	
[0] * OFF		
[1] Enabled	When set for <i>Enabled</i> , an auto set-up sequence is activated, automatically setting speed to approx. 50% and 85% of rated motor speed (4-13 Motor Speed High Limit [RPM], 4-14 Motor Speed High Limit [Hz]). At those two speeds, the power consumption is automatically measured and stored. Before enabling Auto Set-up: <ol style="list-style-type: none"> 1. Close valve(s) in order to create a no-flow condition 2. The Adjustable frequency drive must be set for Open-Loop (1-00 Configuration Mode). Note that it is important also to set 1-03 Torque Characteristics.	

NOTE!

Auto set-up must be done when the system has reached normal operating temperature!

NOTE!

It is important that the 4-13 Motor Speed High Limit [RPM] or 4-14 Motor Speed High Limit [Hz] is set to the max. operational speed of the motor!

It is important to do the auto set-up before configuring the integrated PI controller as settings will be reset when changing from Closed to Open-Loop in 1-00 Configuration Mode.

NOTE!

Carry out the tuning with the same settings in 1-03 Torque Characteristics, as for operation after the tuning.

22-21 Low Power Detection		
Option:	Function:	
[0] * Disabled		
[1] Enabled	If selecting Enabled, the Low Power Detection commissioning must be carried out in order to set the parameters in parameter group 22-3* for proper operation!	

22-22 Low Speed Detection		
Option:	Function:	
[0] * Disabled		
[1] Enabled	Select Enabled for detecting when the motor operates with a speed as set in 4-11 Motor Speed Low Limit [RPM] or 4-12 Motor Speed Low Limit [Hz].	

22-23 No-Flow Function		
Common actions for Low Power Detection and Low Speed Detection (Individual selections not possible).		
Option:	Function:	
[0] * OFF		
[1] Sleep Mode	The adjustable frequency drive will enter Sleep Mode and stop when a No-Flow condition is detected. See parameter group 22-4* for programming options for Sleep Mode.	
[2] Warning	The drive will continue to run, but activate a No-Flow Warning [W92]. A drive digital output or a serial communication bus can communicate a warning to other equipment.	
[3] Alarm	The adjustable frequency drive will stop running and activate a No-Flow Alarm [A 92]. An adjustable frequency drive digital output or a serial communication bus can communicate an alarm to other equipment.	

NOTE!

Do not set *14-20 Reset Mode* to [13] Infinite auto reset when *22-23 No-Flow Function* is set to [3] Alarm. Doing so will cause the adjustable frequency drive to continuously cycle between running and stopping when a No-Flow condition is detected.

NOTE!

If the adjustable frequency drive is equipped with a constant speed bypass with an automatic bypass function that starts the bypass if the adjustable frequency drive experiences a persistent alarm condition, be sure to disable the bypass's automatic bypass function, if [3] Alarm is selected as the No-Flow Function.

22-24 No-Flow Delay		
Range:	Function:	
10 s* [1 - 600 s]	Set the time. Low Power/Low Speed must remain detected to activate signal for actions. If detection disappears before the timer runs out, the timer will be reset.	

22-26 Dry Pump Function		
Select desired action for dry pump operation.		
Option:	Function:	
[0] * OFF		
[1] Warning	The adjustable frequency drive will continue to run but activate a Dry Pump warning [W93]. An adjustable frequency drive digital output or a serial communication bus can communicate a warning to other equipment.	
[2] Alarm	The adjustable frequency drive will stop running and activate a Dry Pump alarm [A93]. An adjustable frequency drive digital output or a serial communication bus can communicate an alarm to other equipment.	
[3] Man. Reset Alarm	The adjustable frequency drive will stop running and activate a Dry Pump alarm [A93]. An adjustable frequency drive digital output or a serial communication bus can communicate an alarm to other equipment.	

NOTE!

Low Power Detection must be Enabled (22-21 Low Power Detection) and commissioned (using either parameter group 22-3*, No-Flow Power Tuning, or 22-20 Low Power Auto Set-up) in order to use Dry Pump Detection.

NOTE!

Do not set *14-20 Reset Mode*, to [13] Infinite auto reset, when *22-26 Dry Pump Function* is set to [2] Alarm. Doing so will cause the adjustable frequency drive to continuously cycle between running and stopping when a dry pump condition is detected.

NOTE!

If the adjustable frequency drive is equipped with a constant speed bypass with an automatic bypass function that starts the bypass if the adjustable frequency drive experiences a persistent alarm condition, be sure to disable the bypass's automatic bypass function, if [2] Alarm or [3] Man. Reset Alarm is selected as the Dry Pump Function.

22-27 Dry Pump Delay		
Range:	Function:	
10 s* [0 - 600 s]	Defines for how long the Dry Pump condition must be active before activating Warning or Alarm	

3.20.2 22-3* No-Flow Power Tuning

Tuning Sequence, if not choosing *Auto Set-up* in *22-20 Low Power Auto Set-up*:

1. Close the main valve to stop flow
2. Run with motor until the system has reached normal operating temperature
3. Press Hand On button on the LCP and adjust speed for approx. 85% of rated speed. Note the exact speed
4. Read the power consumption either by looking for the actual power in the data line in the LCP or call *16-10 Power [kW]* or *16-11 Power [hp]* in the main menu. Note the power readout
5. Change the speed to approx. 50% of rated speed. Note the exact speed
6. Read the power consumption either by looking for the actual power in the data line in the LCP or call *16-10 Power [kW]* or *16-11 Power [hp]* in the main menu. Note the power readout
7. Program the speeds used in *22-32 Low Speed [RPM]*, *22-33 Low Speed [Hz]*, *22-36 High Speed [RPM]* and *22-37 High Speed [Hz]*
8. Program the associated power values in *22-34 Low Speed Power [kW]*, *22-35 Low Speed Power [HP]*, *22-38 High Speed Power [kW]* and *22-39 High Speed Power [HP]*

9. Switch back by means of *Auto On* or *Off*

NOTE!

Set 1-03 *Torque Characteristics* before tuning takes place.

22-30 No-Flow Power		
Range:		Function:
0.00 kW*	[0.00 - 0.00 kW]	Readout of calculated no-flow power at actual speed. If power drops to the display value the Adjustable frequency drive will consider the condition as a No Flow situation.

22-31 Power Correction Factor		
Range:		Function:
100 %*	[1 - 400 %]	Make corrections to the calculated power at 22-30 <i>No-Flow Power</i> . If No Flow is detected when it should not be detected, the setting should be decreased. However, if No Flow is not detected when it should be detected, the setting should be increased to above 100%.

22-32 Low Speed [RPM]		
Range:		Function:
Size related*	[0 - par. 22-36 RPM]	To be used if 0-02 <i>Motor Speed Unit</i> has been set for RPM (parameter not visible if Hz selected). Set used speed to the 50% level. This function is used for storing values needed to tune No-Flow Detection.

22-33 Low Speed [Hz]		
Range:		Function:
Size related*	[0.0 - par. 22-37 Hz]	To be used if 0-02 <i>Motor Speed Unit</i> has been set for Hz (parameter not visible if RPM selected). Set used speed to the 50% level. The function is used for storing values needed to tune No-Flow Detection.

22-34 Low Speed Power [kW]		
Range:		Function:
Size related*	[0.00 - 0.00 kW]	

22-35 Low Speed Power [HP]		
Range:		Function:
Size related*	[0.00 - 0.00 hp]	

22-36 High Speed [RPM]		
Range:		Function:
Size related*	[0 - par. 4-13 RPM]	To be used if 0-02 <i>Motor Speed Unit</i> has been set for RPM (parameter not visible if Hz selected). Set used speed for the 85% level. The function is used for storing values needed to tune No-Flow Detection.

22-37 High Speed [Hz]		
Range:		Function:
Size related*	[0.0 - par. 4-14 Hz]	To be used if 0-02 <i>Motor Speed Unit</i> has been set for Hz (parameter not visible if RPM selected). Set used speed for the 85% level. The function is used for storing values needed to tune No-Flow Detection.

22-38 High Speed Power [kW]		
Range:		Function:
Size related*	[0.00 - 0.00 kW]	

22-39 High Speed Power [HP]		
Range:		Function:
Size related*	[0.00 - 0.00 hp]	

3.20.3 22-4* Sleep Mode

If the load on the system allows for stop of the motor and the load is monitored, the motor can be stopped by activating the Sleep Mode function. This is not a normal Stop command, but ramps the motor down to 0 RPM and stops energizing the motor. When in Sleep Mode certain conditions are monitored to find out when load has been applied to the system again.

Sleep Mode can be activated either from the No-Flow Detection/Minimum Speed Detection (must be programmed via parameters for No-Flow Detection, see the signal flow-diagram in parameter group 22-2*, No-Flow Detection) or via an external signal applied to one of the digital inputs (must be programmed via the parameters for configuration of the digital inputs, parameter group 5-1* selecting [66] Sleep Mode). Sleep mode is activated only when no wake-up conditions are present.

To make it possible, for example, to use an electro-mechanical flow switch to detect a no-flow condition and activate Sleep Mode, the action takes place at raising edge of the external signal applied (otherwise the Adjustable frequency drive would never come out of Sleep Mode again as the signal would be constantly connected).

NOTE!

If Sleep Mode is to be based on No Flow Detection/ Minimum Speed, remember to choose Sleep Mode [1] in 22-23 No-Flow Function.

If 25-26 Destage At No-Flow is set for Enabled, activating Sleep Mode will send a command to the cascade controller (if enabled) to start de-staging lag pumps (fixed-speed) before stopping the lead pump (variable-speed).

When entering Sleep Mode, the lower status line in the Local Control Panel shows Sleep Mode.

See also signal flow chart in 3.20.1 22-2* No-Flow Detection. There are three different ways of using the Sleep Mode function:

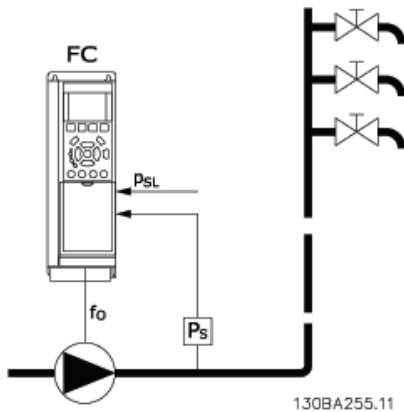

Figure 3.50

1) Systems where the integrated PI controller is used for controlling pressure or temperature, e.g., boost systems with a pressure feedback signal applied to the Adjustable frequency drive from a pressure transducer. 1-00 Configuration Mode must be set for Closed-Loop and the PI controller configured for desired reference and feedback signals.

Example: Boost system.

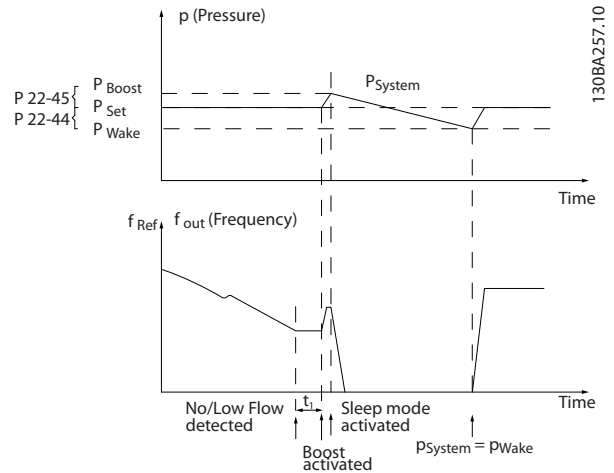

Figure 3.51

If no-flow is detected, the Adjustable frequency drive will increase the setpoint for pressure to ensure a slight overpressure in the system (boost to be set in 22-45 Setpoint Boost).

The feedback from the pressure transducer is monitored and when this pressure has dropped with a set percentage below the normal setpoint for pressure (Pset), the motor will ramp up again and pressure will be controlled for reaching the set value (Pset).

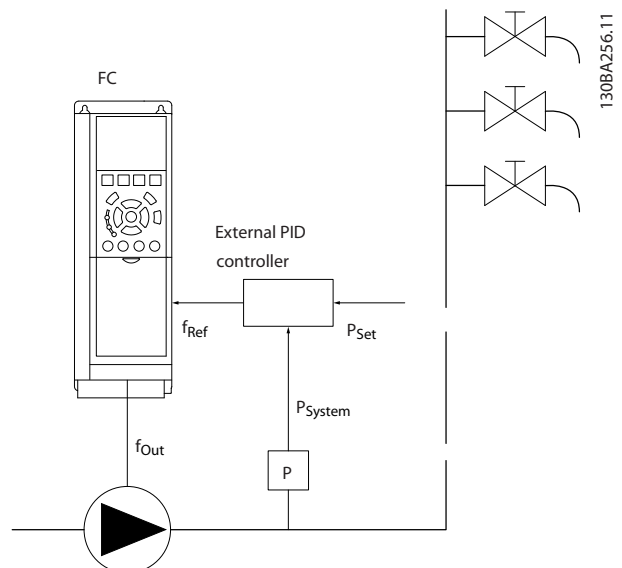

Figure 3.52

2) In systems where the pressure or temperature is controlled by an external PI controller, the wake-up conditions cannot be based on feedback from the pressure/temperature transducer as the setpoint is not

known. In the example with a boost system, desired pressure Pset is not known. *1-00 Configuration Mode* must be set for Open-loop.
 Example: Boost system.

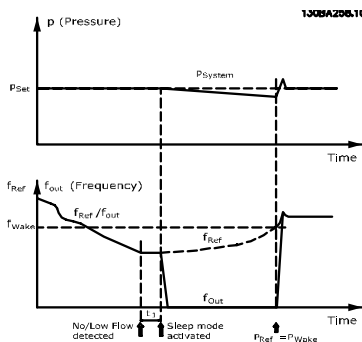

Figure 3.53

When low power or low speed is detected the motor is stopped, but the reference signal (f_{ref}) from the external controller is still monitored and because of the low pressure created, the controller will increase the reference signal to gain pressure. When the reference signal has reached a set value f_{wake} , the motor restarts,.

The speed is set manually by an external reference signal (Remote Reference). The settings (parameter group 22-3*) for tuning of the No-Flow function must be set to default.

	Internal PI Controller (1-00 Configuration Mode: Closed-loop)		External PI Controller or manual control (1-00 Configuration Mode: Open-loop)	
	Sleep mode	Wake up	Sleep mode	Wake up
No-Flow detection (pumps only)	Yes		Yes (except manual setting of speed)	
Low speed detection	Yes		Yes	
External signal	Yes		Yes	
Pressure/Temperature (transmitter connected)		Yes		No
Output frequency		No		Yes

Table 3.29 Configuration possibilities, overview

NOTE!

Sleep Mode will not be active when Local Reference is active (set speed manually by means of arrow buttons on the LCP). See 3-13 Reference Site.
 Does not work in Hand-mode. Auto set-up in open-loop must be carried out before setting input/output in closed-loop.

22-40 Minimum Run Time		
Range:	Function:	
10 s*	[0 - 600 s]	

22-41 Minimum Sleep Time		
Range:	Function:	
10 s*	[0 - 600 s]	Set the desired minimum time for staying in sleep mode. This will override any wake-up conditions.

22-42 Wake-up Speed [RPM]		
Range:	Function:	
Size related*	[par. 4-11 - par. 4-13 RPM]	To be used if 0-02 Motor Speed Unit has been set for RPM (parameter not visible if Hz selected). Only to be used if 1-00 Configuration Mode is set for open-loop and speed reference is applied by an external controller. Set the reference speed at which sleep mode should be canceled.

22-43 Wake-up Speed [Hz]		
Range:	Function:	
Size related*	[par. 4-12 - par. 4-14 Hz]	To be used if 0-02 Motor Speed Unit has been set for Hz (parameter not visible if RPM selected). Only to be used if 1-00 Configuration Mode is set for open-loop and speed reference is applied by an external controller controlling the pressure. Set the reference speed at which sleep mode should be canceled.

22-44 Wake-up Ref./FB Difference		
Range:	Function:	
10 %* [0 - 100 %]	Only to be used if 1-00 Configuration Mode is set for closed-loop and the integrated PI controller is used for controlling the pressure. Set the pressure drop allowed in percentage of setpoint for the pressure (Pset) before canceling the sleep mode.	

NOTE!

If used in application where the integrated PI controller is set for inverse control (e.g., cooling tower applications) in 20-71 PID Performance, the value set in 22-44 Wake-up Ref./FB Difference will automatically be added.

22-45 Setpoint Boost		
Range:	Function:	
0 %* [-100 - 100 %]	Only to be used if 1-00 Configuration Mode, is set for closed-loop and the integrated PI controller is used. For example, in systems with constant pressure control, it is advantageous to increase the system pressure before the motor is stopped. This will extend the time during which the motor is stopped and help to avoid frequent start/stop. Set the desired overpressure/temperature as a percentage of the setpoint for the pressure (Pset)/temperature before entering sleep mode. If set at 5%, the boost pressure will be Pset*1.05. The negative values can be used, for example, for cooling tower control, where a negative change is needed.	

22-46 Maximum Boost Time		
Range:	Function:	
60 s* [0 - 600 s]	Only to be used if 1-00 Configuration Mode is set for closed-loop and the integrated PI controller is used for controlling the pressure. Set the maximum time for which boost mode will be allowed. If the set time is exceeded, sleep mode will be entered and will not wait for the set boost pressure to be reached.	

3.20.4 22-5* End of Curve

The End of Curve conditions occur when a pump is yielding a too large volume to ensure the set pressure. This can occur if there is a leakage in the distribution pipe system after the pump causing the pump to operate at the end of the pump characteristic, valid for the max. speed set in 4-13 Motor Speed High Limit [RPM] or 4-14 Motor Speed High Limit [Hz].

If the feedback is 2.5% of the programmed value in 20-14 Maximum Reference/Feedb. (or numerical value of 20-13 Minimum Reference/Feedb. whichever is highest) below the setpoint for the desired pressure for a set time (22-51 End of Curve Delay), and the pump is running with max. speed set in 4-13 Motor Speed High Limit [RPM] or 4-14 Motor Speed High Limit [Hz], - the function selected in 22-50 End of Curve Function will take place.

It is possible to get a signal on one of the digital outputs by selecting End of Curve [192] in parameter group 5-3* Digital Outputs and/or parameter group 5-4* Relays. The signal will be present when an End of Curve condition occurs and the selection in 22-50 End of Curve Function is different from Off. The end of curve function can only be used when operating with the built-in PID controller (closed-loop in 1-00 Configuration Mode).

22-50 End of Curve Function		
Option:	Function:	
[0] * OFF	End of Curve monitoring not active.	
[1] Warning	The adjustable frequency drive will continue to run, but activate a End of Curve warning [W94]. An adjustable frequency drive digital output or a serial communication bus can communicate a warning to other equipment.	
[2] Alarm	The adjustable frequency drive will stop running and activate a End of Curve alarm [A 94]. An adjustable frequency drive digital output or a serial communication bus can communicate an alarm to other equipment.	
[3] Man. Reset Alarm	The adjustable frequency drive will stop running and activate a End of Curve alarm [A 94]. An adjustable frequency drive digital output or a serial communication bus can communicate an alarm to other equipment.	

NOTE!

Automatic restart will reset the alarm and start the system again.

NOTE!

Do not set 14-20 Reset Mode, to [13] Infinite auto reset, when 22-50 End of Curve Function is set to [2] Alarm. Doing so will cause the adjustable frequency drive to continuously cycle between running and stopping when a End of Curve condition is detected.

NOTE!

If the adjustable frequency drive is equipped with a constant speed bypass with an automatic bypass function that starts the bypass if the adjustable frequency drive experiences a persistent alarm condition, be sure to disable the bypass's automatic bypass function, if [2] Alarm or [3] Man. Reset Alarm is selected as the End of Curve Function.

22-51 End of Curve Delay		
Range:	Function:	
10 s* [0 - 600 s]	When an end of curve condition is detected, a timer is activated. When the time set in this parameter expires and the End of Curve condition has been steady in the entire period, the function set in 22-50 End of Curve Function will be activated. If the condition disappears before the timer expires, the timer will be reset.	

3.20.5 22-6* Broken Belt Detection

Broken belt detection can be used in both closed-loop and open-loop systems for pumps, fans and compressors. If the estimated motor torque is below the broken belt torque value (22-61 Broken Belt Torque) and the adjustable frequency drive output frequency is above or equal to 15 Hz, the broken belt function (22-60 Broken Belt Function) is performed.

22-60 Broken Belt Function		
Selects the action to be performed if the Broken Belt condition is detected		
Option:	Function:	
[0] * OFF		
[1]	Warning	The adjustable frequency drive will continue to run, but will activate a Broken Belt Warning [W95]. An adjustable frequency drive digital output or a serial communication bus can communicate a warning to other equipment.
[2]	Trip	The adjustable frequency drive will stop running and activate a Broken Belt alarm [A 95]. An adjustable frequency drive digital output or a serial communication bus can communicate an alarm to other equipment.

NOTE!

Do not set 14-20 Reset Mode to [13] Infinite auto reset when 22-60 Broken Belt Function is set to [2] Trip. Doing so will cause the adjustable frequency drive to continuously cycle between running and stopping when a broken belt condition is detected.

NOTE!

If the adjustable frequency drive is equipped with a constant speed bypass with an automatic bypass function that starts the bypass if the adjustable frequency drive experiences a persistent alarm condition, be sure to disable the bypass's automatic bypass function, if [2] Trip is selected as the Broken Belt Function.

22-61 Broken Belt Torque		
Range:	Function:	
10 %* [0 - 100 %]	Sets the broken belt torque as a percentage of the rated motor torque.	

22-62 Broken Belt Delay		
Range:	Function:	
10 s [0 - 600 s]	Sets the time for which the broken belt conditions must be active before carrying out the action selected in 22-60 Broken Belt Function.	

3.20.6 22-7* Short Cycle Protection

When controlling refrigeration compressors, often there will be a need for limiting the numbers of starts. One way to do this is to ensure a minimum run time (time between a start and a stop) and a minimum interval between starts. This means that any normal stop command can be overridden by the *Minimum Run Time* function (22-77 Minimum Run Time) and any normal start command (Start/Jog/Freeze) can be overridden by the *Interval Between Starts* function (22-76 Interval between Starts). None of the two functions are active if *Hand On* or *Off* modes have been activated via the LCP. If selecting *Hand On* or *Off*, the two timers will be reset to 0, and not start counting until *Auto* is pressed and an active start command applied.

NOTE!

A Coast command or missing Run Permissive signal will override both Minimum Run Time and Interval Between Starts functions.

22-75 Short Cycle Protection		
Option:	Function:	
[0] * Disabled	Timer set in 22-76 Interval between Starts is disabled.	
[1]	Enabled	Timer set in 22-76 Interval between Starts is enabled.

22-76 Interval between Starts		
Range:	Function:	
Size related*	[par. 22-77 - 3600 s]	Sets the time desired as minimum time between two starts. Any normal start command (Start/Jog/Freeze) will be disregarded until the timer has expired.

22-77 Minimum Run Time		
Range:	Function:	
0 s*	[0 - par. 22-76 s]	Sets the time desired as minimum run time after a normal start command (Start/Jog/Freeze). Any normal stop command will be disregarded until the set time has expired. The timer will start counting following a normal start command (Start/Jog/Freeze). The timer will be overridden by a Coast (Inverse) or an External Interlock command.

NOTE!

Does not work in cascade mode.

3.20.7 22-8* Flow Compensation

It is sometimes the case that it is not possible for a pressure transducer to be placed at a remote point in the system and it can only be located close to the fan/pump outlet. Flow compensation operates by adjusting the setpoint according to the output frequency, which is almost proportional to flow, thus compensating for higher losses at higher flow rates.

H_{DESIGN} (Required pressure) is the setpoint for closed-loop (PI) operation of the Adjustable frequency drive and is set as for closed-loop operation without flow compensation.

It is recommended to use slip compensation and RPM as unit.

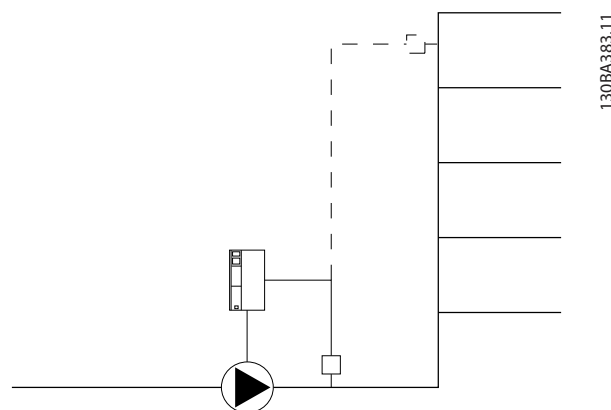

Figure 3.54

NOTE!

When flow compensation is used with the Cascade Controller (parameter group 25-**), the actual setpoint will not depend on speed (flow) but on the number of pumps cut in. See below:

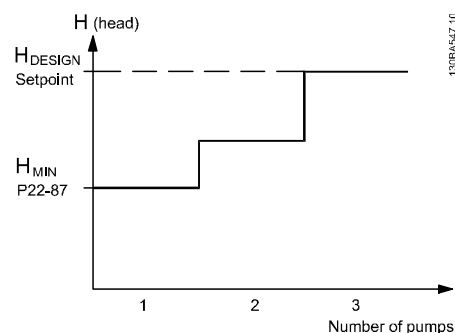

Figure 3.55

There are two methods which can be employed, depending upon whether or not the Speed at System design Working Point is known.

Parameter used	Speed at Design Point KNOWN	Speed at Design Point UNKNOWN	Cascade Controller
22-80 Flow Compensation	+	+	+
22-81 Square-linear Curve Approximation	+	+	-
22-82 Work Point Calculation	+	+	-
22-83 Speed at No-Flow [RPM]/22-84 Speed at No-Flow [Hz]	+	+	-
22-85 Speed at Design Point [RPM]/22-86 Speed at Design Point [Hz]	+	-	-
22-87 Pressure at No-Flow Speed	+	+	+
22-88 Pressure at Rated Speed	-	+	-
22-89 Flow at Design Point	-	+	-
22-90 Flow at Rated Speed	-	+	-

Table 3.30

22-80 Flow Compensation		
Option:	Function:	
[0] *	Disabled	Setpoint compensation not active.
[1]	Enabled	Setpoint compensation is active. Enabling this parameter allows the Flow Compensated Setpoint operation.

22-81 Square-linear Curve Approximation		
Range:	Function:	
100 %*	[0 - 100 %]	

NOTE!

Not visible when running in cascade.

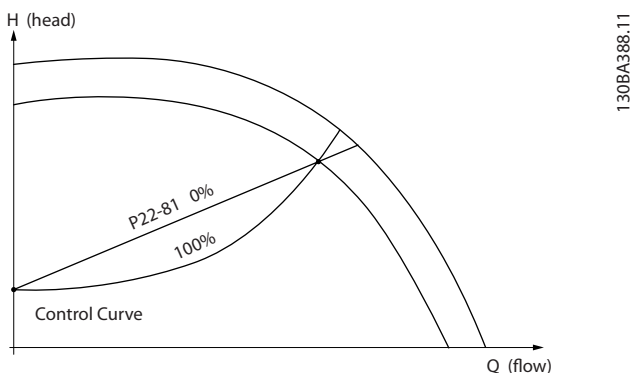

Figure 3.56

22-82 Work Point Calculation		
Option:	Function:	
	Example 1: Speed at system design working point is known:	

22-82 Work Point Calculation	
Option:	Function:
	<p>Figure 3.57</p> <p>From the data sheet showing characteristics for the specific equipment at different speeds, simply reading across from the H_{DESIGN} point and the Q_{DESIGN} point allows us to find point A, which is the System Design Working Point. The pump characteristics at this point should be identified and the associated speed programmed. Closing the valves and adjusting the speed until H_{MIN} has been achieved allows the speed at the no-flow point to be identified.</p> <p>Adjustment of 22-81 <i>Square-linear Curve Approximation</i> then allows the shape of the control curve to be adjusted infinitely.</p> <p>Example 2: Speed at System Design Working Point is not known: Where the Speed at System Design Working Point is unknown, another reference point on the control curve needs to be determined by means of the data sheet. By looking at the curve for the rated speed and plotting the design pressure (H_{DESIGN}, Point C) the flow at that pressure Q_{RATED} can be determined. Similarly, by plotting the design flow (Q_{DESIGN}, Point D), the pressure H_D at that flow can be determined. Knowing these two points on the</p>

Please also see 22-82 *Work Point Calculation* point A.

22-89 Flow at Design Point		
Range:		Function:
0.000 *	[0.000 - 999999.999]	Enter the value corresponding to the Flow at Design Point. No units necessary.

Please also see 22-82 *Work Point Calculation* point C.

22-90 Flow at Rated Speed		
Range:		Function:
0.000 *	[0.000 - 999999.999]	Enter the value corresponding to Flow at Rated Speed. This value can be defined using the pump datasheet.

3.21 Main Menu - Time-based Functions - Group 23

3.21.1 23-0* Timed Actions

Use *Timed Actions* for actions needing to be performed on a daily or weekly basis, e.g., different references for working hours / non-working hours. Up to 10 Timed Actions can be programmed in the Adjustable frequency drive. The Timed Action number is selected from the list when entering parameter group 23-0* from the LCP. 23-00 ON Time – 23-04 Occurrence then refer to the selected Timed Action number. Each Timed Action is divided into an ON time and an OFF time, in which two different actions may be performed.

The clock control (parameter group 0-7* *Clock Settings*) of Timed Actions can be overridden from *Timed Actions Auto* (Clock Controlled) to *Timed Actions Disabled*, *Constant OFF Actions* or *Constant ON Actions* either in 23-08 *Timed Actions Mode* or with commands applied to the digital inputs ([68] *Timed Actions Disabled*, [69] *Constant OFF Actions* or [70] *Constant ON Actions*, in parameter group 5-1* *Digital Inputs*).

Display lines 2 and 3 in the LCP show the status for Timed Actions mode (0-23 *Display Line 2 Large* and 0-24 *Display Line 3 Large*, setting [1643] *Timed Actions Status*).

NOTE!

A change in mode via the digital inputs can only take place if 23-08 *Timed Actions Mode* is set for [0] *Times Actions Auto*.

If commands are applied simultaneously to the digital inputs for Constant OFF and Constant ON, Timed Actions mode will change to Timed Actions Auto and the two commands will be disregarded.

If 0-70 *Date and Time* is not set or the Adjustable frequency drive is set to HAND or OFF mode (e.g., via the LCP), the Timed Actions mode will be change to *Timed Actions Disabled*.

The Timed Actions have a higher priority than the same actions/commands activated by the digital inputs or the Smart Logic Controller.

The actions programmed in Timed Actions are merged with corresponding actions from digital inputs, control word via bus and Smart Logic Controller, according to merge rules set up in parameter group 8-5*, *Digital/Bus*.

NOTE!

The clock (parameter group 0-7*) must be correctly programmed for Timed Actions to function correctly.

NOTE!

When mounting an analog I/O MCB 109 option card, a battery backup of the date and time is included.

NOTE!

The PC-based Configuration Tool MCT 10 comprise a special guide for easy programming of Timed Actions.

23-00 ON Time		
Array [10]		
Range:	Function:	
Size related*	[0 - 0]	Sets the ON time for the Timed Action.
NOTE! The Adjustable frequency drive has no backup of the clock function and the set date/time will reset to default (2000-01-01 00:00) after a power-down unless a Real Time Clock module with backup is installed. In 0-79 <i>Clock Fault</i> it is possible to program for a Warning in case the clock has not been set properly, e.g. after a power down.		

23-01 ON Action		
Arra [10]		
Option:	Function:	
		Select the action during ON Time. See 13-52 <i>SL Controller Action</i> for descriptions of the options.
[0] *	DISABLED	
[1]	No action	
[2]	Select set-up 1	
[3]	Select set-up 2	
[4]	Select set-up 3	
[5]	Select set-up 4	
[10]	Select preset ref 0	
[11]	Select preset ref 1	
[12]	Select preset ref 2	
[13]	Select preset ref 3	
[14]	Select preset ref 4	
[15]	Select preset ref 5	
[16]	Select preset ref 6	
[17]	Select preset ref 7	
[18]	Select ramp 1	
[19]	Select ramp 2	
[22]	Run	
[23]	Run reverse	

23-01 ON Action		
Array [10]		
Option:	Function:	
[24]	Stop	
[26]	Dcstop	
[27]	Coast	
[32]	Set digital out A low	
[33]	Set digital out B low	
[34]	Set digital out C low	
[35]	Set digital out D low	
[36]	Set digital out E low	
[37]	Set digital out F low	
[38]	Set digital out A high	
[39]	Set digital out B high	
[40]	Set digital out C high	
[41]	Set digital out D high	
[42]	Set digital out E high	
[43]	Set digital out F high	
[60]	Reset Counter A	
[61]	Reset Counter B	
[80]	Sleep Mode	
[90]	Set ECB Bypass Mode	
[91]	Set ECB Drive Mode	
[100]	Reset Alarms	

NOTE!

For choices [32] - [43], see also parameter group 5-3*, *Digital Outputs* and 5-4*, *Relays*.

23-02 OFF Time		
Array [10]		
Range:	Function:	
Size related*	[0 - 0]	Sets the OFF time for the Timed Action.
<p>NOTE! The Adjustable frequency drive has no backup of the clock function and the set date/time will reset to default (2000-01-01 00:00) after a power-down unless a Real Time Clock module with backup is installed. In <i>0-79 Clock Fault</i> it is possible to program for a Warning in case the clock has not been set properly, e.g. after a power down.</p>		

23-03 OFF Action		
Array [10]		
Option:	Function:	
		Select the action during OFF Time. See <i>13-52 SL Controller Action</i> for descriptions of the options.
[0] *	DISABLED	
[1]	No action	
[2]	Select set-up 1	
[3]	Select set-up 2	
[4]	Select set-up 3	
[5]	Select set-up 4	
[10]	Select preset ref 0	
[11]	Select preset ref 1	
[12]	Select preset ref 2	
[13]	Select preset ref 3	
[14]	Select preset ref 4	
[15]	Select preset ref 5	
[16]	Select preset ref 6	
[17]	Select preset ref 7	
[18]	Select ramp 1	
[19]	Select ramp 2	
[22]	Run	
[23]	Run reverse	
[24]	Stop	
[26]	Dcstop	
[27]	Coast	
[32]	Set digital out A low	
[33]	Set digital out B low	
[34]	Set digital out C low	
[35]	Set digital out D low	
[36]	Set digital out E low	
[37]	Set digital out F low	
[38]	Set digital out A high	
[39]	Set digital out B high	
[40]	Set digital out C high	
[41]	Set digital out D high	
[42]	Set digital out E high	
[43]	Set digital out F high	
[60]	Reset Counter A	
[61]	Reset Counter B	
[80]	Sleep Mode	
[90]	Set ECB Bypass Mode	
[91]	Set ECB Drive Mode	
[100]	Reset Alarms	

23-04 Occurrence		
Array [10]		
Option:	Function:	
	Select the day(s) to which the timed action applies. Specify working/non-working days in <i>0-81 Working Days</i> , <i>0-82 Additional Working Days</i> and <i>0-83 Additional Non-Working Days</i> .	
[0] *	All days	
[1]	Working days	
[2]	Non-working days	
[3]	Monday	
[4]	Tuesday	
[5]	Wednesday	
[6]	Thursday	
[7]	Friday	
[8]	Saturday	
[9]	Sunday	

23-08 Timed Actions Mode		
Used to enable and disable automatic timed actions.		
Option:	Function:	
[0] *	Timed Actions Auto	Enable timed actions.
[1]	Timed Actions Disab.	Disable timed actions, normal operation according to control commands.
[2]	Constant On Actions	Disable timed actions. Constant On Actions activated.
[3]	Constant Off Actions	Disable timed actions. Constant Off Actions activated.

23-09 Timed Actions Reactivation		
Option:	Function:	
[0]	Disabled	After an update of time/condition (power cycling, setting date and time, change of summertime, change of hand auto mode, change of Constant ON and OFF, set-up change), all activated ON actions will be overridden to OFF actions until passing the next time for an ON action. Any OFF actions will remain unchanged.
[1] *	Enabled	After an update of time/condition, On and OFF actions are immediately set to the actual time programming of ON and OFF actions.

To see an example of a reactivation test, see *Figure 3.59*.

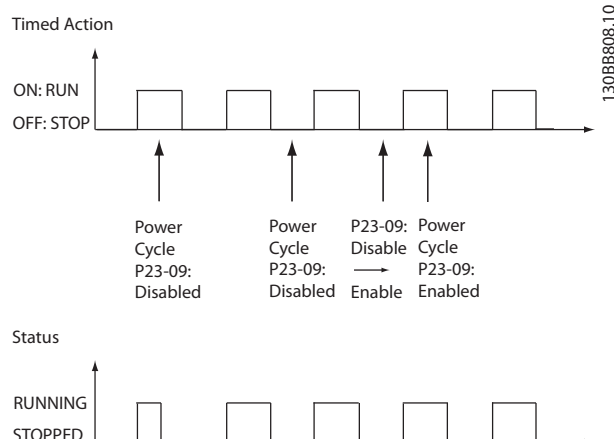

Figure 3.59 Reactivation Test Diagram

3.21.2 23-1* Maintenance

Wear and tear calls for periodic inspection and service of elements in the application, e.g., motor bearings, feedback sensors and seals or filters. Using preventive maintenance, the service intervals may be programmed into the Adjustable frequency drive. The Adjustable frequency drive will give a message when maintenance is required. 20 Preventive Maintenance Events can be programmed into the Adjustable frequency drive. The following must be specified for each Event:

- Maintenance item (e.g., "Motor Bearings")
- Maintenance action (e.g., "Replace")
- Maintenance Time Base (e.g., "Running Hours" or a specific date and time)
- Maintenance Time Interval or the date and time of next maintenance

NOTE!

To disable a Preventive Maintenance Event the associated **23-12 Maintenance Time Base** must be set to **Disabled [0]**.

Preventive Maintenance can be programmed from the LCP, but use of the PC-based VLT Motion Control Tool MCT10 is recommended.

ID	Name	Setup 1	Setup 2	Setup 3	Setup 4
2310.0	Maintenance Item	Motor bearings	Motor bearings	Motor bearings	Motor bearings
2310.1	Maintenance Item	Motor bearings	Motor bearings	Motor bearings	Motor bearings
2310.2	Maintenance Item	Motor bearings	Motor bearings	Motor bearings	Motor bearings
2310.3	Maintenance Item	Motor bearings	Motor bearings	Motor bearings	Motor bearings
2310.4	Maintenance Item	Motor bearings	Motor bearings	Motor bearings	Motor bearings
2310.5	Maintenance Item	Motor bearings	Motor bearings	Motor bearings	Motor bearings
2310.6	Maintenance Item	Motor bearings	Motor bearings	Motor bearings	Motor bearings
2310.7	Maintenance Item	Motor bearings	Motor bearings	Motor bearings	Motor bearings
2310.8	Maintenance Item	Motor bearings	Motor bearings	Motor bearings	Motor bearings
2310.9	Maintenance Item	Motor bearings	Motor bearings	Motor bearings	Motor bearings
2310.10	Maintenance Item	Motor bearings	Motor bearings	Motor bearings	Motor bearings
2310.11	Maintenance Item	Motor bearings	Motor bearings	Motor bearings	Motor bearings
2310.12	Maintenance Item	Motor bearings	Motor bearings	Motor bearings	Motor bearings
2310.13	Maintenance Item	Motor bearings	Motor bearings	Motor bearings	Motor bearings
2310.14	Maintenance Item	Motor bearings	Motor bearings	Motor bearings	Motor bearings
2310.15	Maintenance Item	Motor bearings	Motor bearings	Motor bearings	Motor bearings
2310.16	Maintenance Item	Motor bearings	Motor bearings	Motor bearings	Motor bearings
2310.17	Maintenance Item	Motor bearings	Motor bearings	Motor bearings	Motor bearings
2310.18	Maintenance Item	Motor bearings	Motor bearings	Motor bearings	Motor bearings
2310.19	Maintenance Item	Motor bearings	Motor bearings	Motor bearings	Motor bearings
2311.0	Maintenance Action	Lubricate	Lubricate	Lubricates	Lubricate
2311.2	Maintenance Action	Lubricate	Lubricate	Lubricates	Lubricate
2311.3	Maintenance Action	Lubricate	Lubricate	Lubricates	Lubricate
2311.4	Maintenance Action	Lubricate	Lubricate	Lubricates	Lubricate
2311.5	Maintenance Action	Lubricate	Lubricate	Lubricates	Lubricate
2311.6	Maintenance Action	Lubricate	Lubricate	Lubricates	Lubricate

Figure 3.60

The LCP indicates (with a wrench-icon and an “M”) when it is time for a Preventive Maintenance Action, and can be programmed to be indicated on a digital output in parameter group 5-3*. The Preventive Maintenance Status may be read in *16-96 Maintenance Word*. A Preventive Maintenance indication can be reset from a digital input, the FC bus or manually from the LCP through *23-15 Reset Maintenance Word*.

A Maintenance Log with the latest 10 loggings can be read from parameter group 18-0* and via the Alarm log button on the LCP after selecting Maintenance Log.

NOTE!

The Preventive Maintenance Events are defined in a 20 element array. Hence each Preventive Maintenance Event must use the same array element index in *23-10 Maintenance Item* to *23-14 Maintenance Date and Time*.

23-10 Maintenance Item	
Option:	Function:
	Array with 20 elements displayed below parameter number in the display. Press [OK] and step between

23-10 Maintenance Item	
Option:	Function:
	elements by means of and buttons on the LCP. Select the item to be associated with the preventive maintenance event.
[1] *	Motor bearings
[2]	Fan bearings
[3]	Pump bearings
[4]	Valve
[5]	Pressure transmitter
[6]	Flow transmitter
[7]	Temperature transm.
[8]	Pump seals
[9]	Fan belt
[10]	Filter
[11]	Drive cooling fan
[12]	System health check
[13]	Warranty
[20]	Maintenance Text 0
[21]	Maintenance Text 1
[22]	Maintenance Text 2
[23]	Maintenance Text 3
[24]	Maintenance Text 4
[25]	Maintenance Text 5

23-11 Maintenance Action		
Option:	Function:	
		Select the action to be associated with the preventive maintenance event.
[1]	Lubricate	
[2]	Clean	
[3]	Replace	
[4]	Inspect/Check	
[5]	Overhaul	
[6]	Renew	
[7]	Check	
[20]	Maintenance Text 0	
[21]	Maintenance Text 1	
[22]	Maintenance Text 2	
[23]	Maintenance Text 3	
[24]	Maintenance Text 4	
[25]	Maintenance Text 5	

23-12 Maintenance Time Base		
Option:	Function:	
		Select the time base to be associated with the Preventive Maintenance Event.
[0]	Disabled	<i>Disabled</i> [0] must be used when disabling the Preventive Maintenance Event.
[1]	Running Hours	<i>Running Hours</i> [1] is the number of hours the motor has been running. Running hours are not reset at power-on. The <i>Maintenance Time Interval</i> must be specified in <i>23-13 Maintenance Time Interval</i> .
[2]	Operating Hours	<i>Operating Hours</i> [2] is the number of hours the Adjustable frequency drive has been running. Operating hours are not reset at power-on. The <i>Maintenance Time Interval</i> must be specified in <i>23-13 Maintenance Time Interval</i> .
[3]	Date & Time	<i>Date & Time</i> [3] uses the internal clock. The date and time of the next maintenance occurrence must be specified in <i>23-14 Maintenance Date and Time</i> .

23-13 Maintenance Time Interval		
Range:	Function:	
1 h*	[1 - 2147483647 h]	Set the interval associated with the current preventive maintenance event. This parameter is only used if <i>Running Hours</i> [1] or <i>Operating Hours</i> [2] is selected in <i>23-12 Maintenance Time Base</i> . The timer is reset from <i>23-15 Reset Maintenance Word</i> . Example: A preventive maintenance event is set up for Monday at 8:00. <i>23-12 Maintenance Time</i>

23-13 Maintenance Time Interval		
Range:	Function:	
		<i>Base</i> is <i>Operating hours</i> [2] and <i>23-13 Maintenance Time Interval</i> is 7 x 24 hours=168 hours. The next maintenance event will be indicated the following Monday at 8:00. If this maintenance event is not reset until Tuesday at 9:00, the next occurrence will be the following Tuesday at 9:00.

23-14 Maintenance Date and Time		
Range:	Function:	
Size related*	[0 - 0]	Set the date and time for next maintenance occurrence if the preventive maintenance event is based on date/time. Date format depends on the setting in <i>0-71 Date Format</i> while the time format depends on the setting in <i>0-72 Time Format</i> . NOTE! The Adjustable frequency drive has no backup of the clock function and the set date/time will reset to default (2000-01-01 00:00) after a power-down. In <i>0-79 Clock Fault</i> , it is possible to program for a warning in case the clock has not been set properly, e.g., after a power-down. The time set must be at least one hour away from the current time! NOTE! When mounting an analog I/O MCB 109 option card, a battery backup of the date and time is included.

23-15 Reset Maintenance Word		
Option:	Function:	
		Set this parameter to <i>Do reset</i> [1] to reset the Maintenance Word in <i>16-96 Maintenance Word</i> and reset the message displayed in the LCP. This parameter will change back to <i>Do not reset</i> [0] when pressing OK.
[0] *	Do not reset	
[1]	Do reset	

NOTE!

When messages are reset - Maintenance Item, Action and Maintenance Date/Time are not cancelled.
23-12 Maintenance Time Base is set to Disabled [0].

23-16 Maintenance Text		
Range:	Function:	
0 *	[0 - 0]	

3.21.3 23-5* Energy Log

The Adjustable frequency drive is continuously accumulating the consumption of the motor controlled, based on the actual power yielded by the Adjustable frequency drive.

These data can be used for an Energy Log function allowing the user to compare and structure the information about the energy consumption related to time.

There are basically two functions:

- Data related to a pre-programmed period, defined by a set date and time for start
- Data related to a predefined period back in time, e.g., the last seven days within the pre-programmed period

For each of the above two functions, the data are stored in a number of counters allowing for selecting the time frame and a split on hours, days or weeks.

The period/split (resolution) can be set in *23-50 Energy Log Resolution*.

The data are based on the value registered by the kWh counter in the Adjustable frequency drive. This counter value can be read in *15-02 kWh Counter* containing the accumulated value since the first power-up or latest reset of the counter (*15-06 Reset kWh Counter*).

All data for the energy log are stored in counters which can be read from *23-53 Energy Log*.

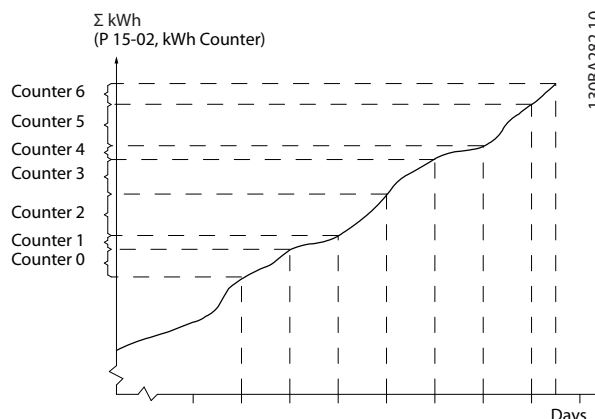

Figure 3.61

Counter 00 will always contain the oldest data. A counter will cover a period from XX:00 to XX:59 if hours or 00:00 to 23:59 if days.

If logging either the last hours or last days, the counters will shift contents at XX:00 every hour or at 00:00 every day.

Counter with highest index will always be subject to update (containing data for the actual hour since XX:00 or the actual day since 00:00).

The contents of counters can be displayed as bars on LCP. Select *Quick Menu, Loggings, Energy Log: Trending Continued Bin / Trending Timed Bin / Trending Comparison*.

23-50 Energy Log Resolution		
Option:	Function:	
	Select the desired type of period for logging of consumption. Hour of Day [0], Day of Week [1] or Day of Month [2]. The counters contain the logging data from the programmed date/time for start (23-51 <i>Period Start</i>) and the numbers of hours/days as programmed for (23-50 <i>Energy Log Resolution</i>). The logging will start on the date programmed in 23-51 <i>Period Start</i> , and continue until one day/week/month has gone. Last 24 Hours [5], Last 7 Days [6] or Last 5 Weeks [7]. The counters contain data for one day, one week or five weeks back in time and up to the current time. The logging will start at the date programmed in 23-51 <i>Period Start</i> . In all cases, the period split will refer to Operating Hours (time where Adjustable frequency drive is powered up).	
[0]	Hour of Day	
[1]	Day of Week	
[2]	Day of Month	
[5] *	Last 24 Hours	
[6]	Last 7 Days	
[7]	Last 5 Weeks	

NOTE!

The Adjustable frequency drive has no backup of the clock function and the set date/time will reset to default (2000-01-01 00:00) after a power-down unless a Real Time Clock module with backup is installed. Consequently the logging will be stopped until date/time is readjusted in 0-70 *Date and Time*. In 0-79 *Clock Fault* it is possible to program for a warning in case the clock has not been set properly, e.g., after a power-down.

23-51 Period Start		
Range:	Function:	
Size related*	[0 - 0]	

NOTE!

When mounting an Analog I/O MCB 109 option card, a battery backup of the date and time is included.

23-53 Energy Log		
Range:	Function:	
0 * 4294967295]	Array with a number of elements equal to the number of counters ([00]-[xx] below parameter number in display). Press OK and Step between elements by means of ▲ and ▼ buttons on the Local Control Panel. Array elements:	
<p>Figure 3.63</p> <p>Data from latest period is stored in the counter with the highest index. At power-down, all counter values are stored and resumed at next power-up.</p>		

NOTE!

All counters are automatically reset when changing the setting in 23-50 *Energy Log Resolution*. At overflow the update of the counters will stop at maximum value.

NOTE!

When mounting an Analog I/O MCB 109 option card, a battery backup of the date and time is included.

23-54 Reset Energy Log		
Option:	Function:	
	Select <i>Do reset</i> [1] to reset all values in the Energy Log counters shown in 23-53 <i>Energy Log</i> . After pressing OK, the setting of the parameter value will automatically change to <i>Do not reset</i> [0].	
[0]	Do not reset	
[1]	Do reset	

3.21.4 23-6* Trending

Trending is used to monitor a process variable over a period of time and record how often the data falls into each of ten user-defined data ranges. This is a convenient tool to get a quick overview indicating where to put focus for improvement of operation.

Two sets of data for trending can be created in order to make it possible to compare current values for a selected operating variable with data for a certain reference period, for the same variable. This reference period can be pre-programmed (23-63 *Timed Period Start* and 23-64 *Timed Period Stop*). The two sets of data can be read from 23-61 *Continuous Bin Data* (current) and 23-62 *Timed Bin Data* (reference).

It is possible to create trending for following operation variables:

- Power
- Current
- Output frequency
- Motor Speed

The trending function includes ten counters (forming a bin) for each set of data containing the numbers of registrations reflecting how often the operating variable is within each of ten pre-defined intervals. The sorting is based on a relative value of the variable.

The relative value for the operating variable is

$$\text{Actual/Rated} * 100\%$$

for Power and Current and

$$\text{Actual/Max} * 100\%$$

for Output Frequency and Motor Speed.

The size of each interval can be adjusted individually, but default will be 10% for each. Power and current can exceed rated value, but those registrations will be included in the 90%–100% (MAX) counter.

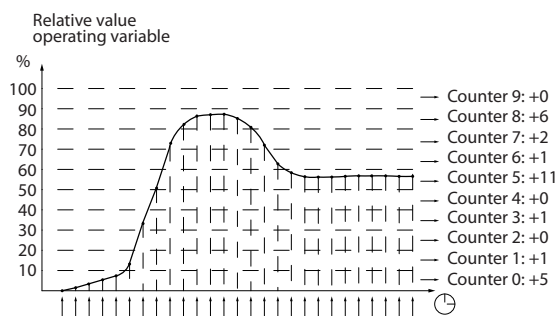

Figure 3.64

Once a second, the value of the operating variable selected is registered. If a value has been registered to equal 13%, the counter “10% - <20%” will be updated with the value “1”. If the value stays at 13% for 10s, then “10” will be added to the counter value.

The contents of counters can be displayed as bars on LCP. Select *Quick Menu >Loggings: Trending Continued Bin / Trending Timed Bin / Trending Comparison*.

NOTE!

The counters starts counting whenever the Adjustable frequency drive is powered up. Power cycle shortly after a reset will zero the counters. EEPROM data are updated once per hour.

23-60 Trend Variable		
Option:	Function:	
		Select the desired operating variable to be monitored for trending.
[0] *	Power [kW]	Power yielded to the motor. Reference for the relative value is the rated motor power programmed in 1-20 <i>Motor Power [kW]</i> or 1-21 <i>Motor Power [HP]</i> . Actual value can be read in 16-10 <i>Power [kW]</i> or 16-11 <i>Power [hp]</i> .
[1]	Current [A]	Output current to the motor. Reference for the relative value is the rated motor current programmed in 1-24 <i>Motor Current</i> . Actual value can be read in 16-14 <i>Motor Current</i> .
[2]	Frequency [Hz]	Output frequency to the motor. Reference for the relative value is the maximum output frequency programmed in 4-14 <i>Motor Speed High Limit [Hz]</i> . Actual value can be read in 16-13 <i>Frequency</i> .
[3]	Motor Speed [RPM]	Speed of the motor. Reference for relative value is the maximum motor speed programmed in 4-13 <i>Motor Speed High Limit [RPM]</i> .

23-61 Continuous Bin Data	
Range:	Function:
0 * [0 - 4294967295]	<p>Array with 10 elements ([0]-[9] below parameter number in display). Press OK and step between elements by means of ▲ and ▼ buttons on the LCP.</p> <p>10 counters with the frequency of occurrence for the operating variable monitored, sorted according to the following intervals:</p> <ul style="list-style-type: none"> Counter [0]: 0%—<10% Counter [1]: 10%—<20% Counter [2]: 20%—<30% Counter [3]: 30%—<40% Counter [4]: 40%—<50% Counter [5]: 50%—<60% Counter [6]: 60%—<70% Counter [7]: 70%—<80% Counter [8]: 80%—<90% Counter [9]: 90%—<100% or Max <p>The above minimum limits for the intervals are the default limits. These can be changed in 23-65 <i>Minimum Bin Value</i>.</p> <p>Starts to count when the Adjustable frequency drive is powered up for the first time. All counters can be reset to 0 in 23-66 <i>Reset Continuous Bin Data</i>.</p>

23-62 Timed Bin Data	
Range:	Function:
0 * [0 - 4294967295]	<p>Array with 10 elements ([0]-[9] below parameter number in display). Press OK and step between elements by means of ▲ and ▼ buttons on the LCP.</p> <p>10 counters with the frequency of occurrence for the operating data monitored sorted according to the intervals as for 23-61 <i>Continuous Bin Data</i>.</p> <p>Starts to count at the date/time programmed in 23-63 <i>Timed Period Start</i>, and stops at the time/date programmed in 23-64 <i>Timed Period Stop</i>. All counters can be reset to 0 in 23-67 <i>Reset Timed Bin Data</i>.</p>

23-63 Timed Period Start	
Range:	Function:
Size related* [0 - 0]	<p>Set the date and time at which trending starts the update of the timed bin counters.</p> <p>Date format will depend on setting in 0-71 <i>Date Format</i>, and time format on setting in 0-72 <i>Time Format</i>.</p>

NOTE!

The Adjustable frequency drive has no backup of the clock function and the set date/time will reset to default (2000-01-01 00:00) after a power-down unless a Real Time Clock module with backup is installed. Consequently the logging will be stopped until date/time is readjusted in 0-70 *Date and Time*. In 0-79 *Clock Fault* it is possible to program for a warning in case the clock has not been set properly, e.g., after a power-down.

NOTE!

When mounting an analog I/O MCB 109 option card, a battery backup of the date and time is included.

23-64 Timed Period Stop	
Range:	Function:
Size related* [0 - 0]	

NOTE!

When mounting an Analog I/O MCB 109 option card, a battery backup of the date and time is included.

23-65 Minimum Bin Value	
Range:	Function:
Size related* [0 - 100. %]	

23-66 Reset Continuous Bin Data	
Option:	Function:
	<p>Select <i>Do reset</i> [1] to reset all values in 23-61 <i>Continuous Bin Data</i>.</p> <p>After pressing OK, the setting of the parameter value will automatically change to <i>Do not reset</i> [0].</p>
[0]	Do not reset
[1]	Do reset

23-67 Reset Timed Bin Data		
Option:	Function:	
		Select <i>Do reset</i> [1] to reset all counters in 23-62 Timed Bin Data. After pressing OK, the setting of the parameter value will automatically change to <i>Do not reset</i> [0].
[0]	Do not reset	
[1]	Do reset	

The difference between the Reference Power at fixed speed and the Actual Power yielded with speed control represent the actual savings.

As value for the fixed-speed case, the rated motor size (kW) is multiplied with a factor (set in %) representing the power produced at fixed speed. The difference between this reference power and the actual power is accumulated and stored. The difference in energy can be read in 23-83 Energy Savings.

The accumulated value for the difference in power consumption is multiplied with the energy cost in local currency and the investment is subtracted. This calculation for cost savings can also be read in 23-84 Cost Savings.

Cost Savings =

$$\left\{ \sum_{t=0}^t [(Rated\ Motor\ Power * Power\ Reference\ Factor) - Actual\ Power\ Consumption] \times Energy\ Cost \right\}$$

– Investment Cost

Break even (payback) occurs when the value read in the parameter turns from negative to positive.

It is not possible to reset the Energy Savings counter, but the counter can be stopped any time by setting 23-80 Power Reference Factor to 0.

3.21.5 23-8* Payback Counter

The Adjustable frequency drive includes a feature which can give a rough calculation on payback in cases where the Adjustable frequency drive has been installed in an existing plant to ensure energy saving by changing from fixed to variable-speed control. Reference for the savings is a set value to represent the average power yielded before the upgrade with variable-speed control.

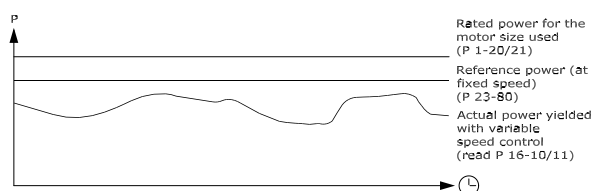

130BA259.11

Figure 3.65

Parameter overview:

Parameter for settings		Parameters for readout	
Rated Motor Power	1-20 Motor Power [kW]	Energy Savings	23-83 Energy Savings
Power Reference Factor in %	23-80 Power Reference Factor	Actual Power	16-10 Power [kW], 16-11 Power [hp]
Energy Cost per kWh	23-81 Energy Cost	Cost Savings	23-84 Cost Savings
Investment	23-82 Investment		

Table 3.31

23-80 Power Reference Factor		
Range:	Function:	
100 %* [0 - 100 %]	Set the percentage of the rated motor size (set in 1-20 Motor Power [kW] or 1-21 Motor Power [HP]) which is supposed to represent the average power yielded at the time running with fixed speed (before upgrade with variable speed control). Must be set to a value different from zero to start counting.	

23-81 Energy Cost		
Range:	Function:	
1.00 * [0.00 - 999999.99]	Set the actual cost for a kWh in local currency. If the energy cost is changed later on, it will impact the calculation for the entire period.	

23-82 Investment		
Range:		Function:
0 *	[0 - 999999999]	Set the value of the investment spent on upgrading the plant with speed control, in same currency as used in <i>23-81 Energy Cost</i> .

23-83 Energy Savings		
Range:		Function:
0 kWh*	[0 - 0 kWh]	This parameter allows for a readout of the accumulated difference between the reference power and the actual output power. If motor size set in hp (<i>1-21 Motor Power [HP]</i>), the equivalent kW value will be used for the Energy Savings.

23-84 Cost Savings		
Range:		Function:
0 *	[0 - 2147483647]	This parameter allows a readout of the calculation based on the above equation (in local currency).

3.22 Main Menu - Application Functions 2 - Group 24

3.22.1 24-0* Fire Mode

CAUTION

Please note the Adjustable frequency drive is only one component of the VLT® HVAC Drive system. Correct function of Fire Mode depends on the correct design and selection of system components. Ventilation systems working in life safety applications have to be approved by the local fire authorities. *Non-interruption of the adjustable frequency drive due to Fire Mode operation could cause over pressure and result in damage to VLT® HVAC Drive system and components, including dampers and air ducts. The Adjustable frequency drive itself could be damaged and it may cause damage or fire. Danfoss accepts no responsibility for errors, malfunctions personal injury or any damage to the Adjustable frequency drive itself or components herein, VLT® HVAC Drive systems and components herein or other property when the Adjustable frequency drive has been programmed for Fire Mode. In no event shall Danfoss be liable to the end user or any other party for any direct or indirect, special or consequential damage or loss suffered by such party, which has occurred due to the Adjustable frequency drive being programmed and operated in Fire Mode.*

Background

Fire Mode is for use in critical situations, where it is imperative for the motor to keep running, regardless of the adjustable frequency drive's normal protective functions. These could be ventilation fans in tunnels or

stairwells for instance, where continued operation of the fan facilitates safe evacuation of personnel in the event of a fire. Some selections of Fire Mode Function cause alarms and trip conditions to be disregarded, enabling the motor to run without interruption.

Activation

Fire mode is activated only via digital input terminals. See parameter group 5-1* Digital Inputs.

Messages in display

When Fire Mode is activated, the display will show a status message "Fire Mode" and a warning "Fire Mode". Once Fire Mode is again deactivated, the status messages will disappear and the warning will be replaced by the warning "Fire M Was Active". This message can only be reset by power-cycling the adjustable frequency drive supply. If, while the Adjustable frequency drive is active in Fire Mode, a warranty-affecting alarm (see 24-09 Fire Mode Alarm Handling) should occur, display will show the warning "Fire M Limits Exceeded".

Digital and relay outputs can be configured for the status messages "Fire Mode Active" and the warning "Fire M Was Active". See parameter group 5-3* and parameter group 5-4*.

"Fire M was Active" messages can also be accessed in the warning word via serial communication. (See relevant documentation).

The status messages "Fire Mode" can be accessed via the extended status word.

Message	Type	LCP	Messages in display	Warning Word 2	Ext. Status Word 2
Fire Mode	Status	+	+		+(bit 25)
Fire Mode	Warning	+			
Fire M was Act.	Warning	+	+	+(bit 3)	
Fire M Lim Exc.	Warning	+	+		

Table 3.32

Log

An overview of events related to fire mode can be viewed in the Fire Mode log, parameter group 18-1*, or via the Alarm Log button on the LCP.

The log will include up to 10 of the latest events. Warranty Affecting Alarms will have a higher priority than the two other types of events.

The log cannot be reset!

Following events are logged:

*Warranty affecting alarms (see 24-09 Fire Mode Alarm Handling, Fire Mode Alarm Handling)

*Fire Mode activated

*Fire Mode deactivated

All other alarms occurring while fire mode activated will be logged as usual.

NOTE!

During Fire Mode operation all stop commands to the Adjustable frequency drive will be ignored, including Coast/Coast inverse and External Interlock. However, if your Adjustable frequency drive incorporates "Safe-Stop", this function is still active. See Section "How to Order / Ordering Form Type Code".

NOTE!

If in fire mode, it is desired to use the live zero function, then it will also be active for analog inputs other than that used for fire mode setpoint/feedback. Should the feedback to any of those other analog inputs be lost, for example a cable is burned, Live Zero function will operate. If this is undesirable, the live zero function must be disabled for those other inputs.

Desired live zero function, if a signal is missing when fire mode is active, must be set in *6-02 Fire Mode Live Zero Timeout Function*.

Warning for Live Zero will have a higher priority than the warning "Fire Mode".

NOTE!

When setting the command Start Reversing [11] on a digital input terminal in *5-10 Terminal 18 Digital Input*, the adjustable frequency drive will understand this as a reversing command.

24-00 Fire Mode Function		
Option:	Function:	
[0] *	Disabled	Fire Mode Function is not active.
[1]	Enabled - Run Fwd	In this mode, the motor will continue to operate in a clockwise direction. Works only in open-loop. Set <i>24-01 Fire Mode Configuration</i> to Open-loop [0].
[2]	Enabled - Run Rev	In this mode, the motor will continue to operate in a counter-clockwise direction. Works only in open-loop. Set <i>24-01 Fire Mode Configuration</i> to Open-loop [0].
[3]	Enabled - Coast	When this mode is enabled, the output is disabled and the motor is allowed to coast to stop.
[4]	Enabled - Run Fwd/Re	

NOTE!

In the above, alarms are produced or ignored in accordance with the selection in *24-09 Fire Mode Alarm Handling*.

24-01 Fire Mode Configuration		
Option:	Function:	
[0] *	Open-loop	When fire mode is active, the motor will run with a fixed speed based on a reference set. The unit will be the same as selected in <i>0-02 Motor Speed Unit</i> .
[3]	Closed-loop	When fire mode is active, the built-in PID controller will control the speed based on the setpoint and a feedback signal, selected in <i>24-07 Fire Mode Feedback Source</i> . The unit to be selected in <i>24-02 Fire Mode Unit</i> . For other PID controller settings use parameter group 20-** as for normal operation. If the motor is also controlled by the built-in PID controller when in normal operation, the same transmitter can be used for both cases by selecting the same source.

NOTE!

Before adjusting the PID controller set *24-09 Fire Mode Alarm Handling*, [2] Trip, All Alarms/Test.

NOTE!

If *Enable-Run Reverse* is selected in *24-00 Fire Mode Function*, *Closed-loop* cannot be selected in *24-01 Fire Mode Configuration*.

24-02 Fire Mode Unit		
Option:	Function:	
		Select the desired unit when fire mode is active and running in closed-loop.
[0]		
[1]	%	
[2]	rpm	
[3]	Hz	
[4]	Nm	
[5]	PPM	
[10]	min	
[11]	RPM	
[12]	PULSE/s	
[20]	liter / sec.	
[21]	liter / min	
[22]	liter / hr.	
[23]	m ³ / sec.	
[24]	m ³ /min	
[25]	m ³ / hr.	
[30]	kg / sec.	
[31]	kg/min	
[32]	kg / hr.	
[33]	ton / min	
[34]	ton / hr.	

24-02 Fire Mode Unit		
Option:	Function:	
[40]	m / sec.	
[41]	m/min	
[45]	m	
[60]	°C	
[70]	mbar	
[71]	bar	
[72]	Pa	
[73]	kPa	
[74]	m WG	
[75]	mm Hg	
[80]	kW	
[120]	GPM	
[121]	gal / sec.	
[122]	gal/min	
[123]	gal / hr.	
[124]	CFM	
[125]	ft ³ /s	
[126]	ft ³ /min	
[127]	ft ³ /h	
[130]	lbs / sec.	
[131]	lbs / min.	
[132]	lbs / hr.	
[140]	ft/s	
[141]	ft/min	
[145]	ft	
[160]	°F	
[170]	psi	
[171]	lb/in ²	
[172]	in. wtr. gage	
[173]	ft WG	
[174]	in Hg	
[180]	HP	

24-03 Fire Mode Min Reference		
Range:	Function:	
Size related*	[-999999.999 - par. 24-04 FireModeUnit]	

24-04 Fire Mode Max Reference		
Range:	Function:	
Size related*	[par. 24-03 - 999999.999 FireModeUnit]	

24-05 Fire Mode Preset Reference		
Range:	Function:	
0.00 %*	[-100.00 - 100.00 %]	

24-06 Fire Mode Reference Source		
Option:	Function:	
		Select the external reference input to be used for fire mode. This signal will be added to the value set in 24-06 Fire Mode Reference Source.
[0]	No function	
[1]	Analog input 53	
[2]	Analog input 54	
[7]	Pulse input 29	
[8]	Pulse input 33	
[20]	Digital pot.meter	
[21]	Analog input X30/11	
[22]	Analog input X30/12	
[23]	Analog Input X42/1	
[24]	Analog Input X42/3	
[25]	Analog Input X42/5	

24-07 Fire Mode Feedback Source		
Option:	Function:	
		Select the feedback input to be used for the fire mode feedback signal when fire mode is active. If the motor also is controlled by the built-in PID controller when in normal operation, the same transmitter can be used for both cases by selecting the same source.
[0] *	No function	
[1]	Analog input 53	
[2]	Analog input 54	
[3]	Pulse input 29	
[4]	Pulse input 33	
[7]	Analog input X30/11	
[8]	Analog input X30/12	
[9]	Analog Input X42/1	
[10]	Analog Input X42/3	
[11]	Analog Input X42/5	
[15]	Analog Input X48/2	
[100]	Bus feedback 1	
[101]	Bus feedback 2	
[102]	Bus feedback 3	

24-09 Fire Mode Alarm Handling		
Option:	Function:	
[0]	Trip+Reset, Crit Alar	If this mode is selected, the Adjustable frequency drive will continue to run, ignoring most alarms, even if doing so it may result in damage of the adjustable frequency drive. Critical alarms are alarms which cannot be suppressed, but a restart attempt is possible (Infinity Automatic Reset).
[1] *	Trip, Critical Alarms	In case of a critical alarm, the Adjustable frequency drive will trip and not auto-restart (Manual Reset).
[2]	Trip, All Alarms/Test	It is possible to test the operation of fire mode, but all alarm states are activated normally (Manual Reset).

NOTE!

Warranty-affecting alarms. Certain alarms can affect the lifetime of the adjustable frequency drive. If one of these disregarded alarms occurs while in Fire Mode, a log of the event is stored in the Fire Mode Log.

This is where the 10 latest events caused by warranty-affecting alarms, fire mode activation and fire mode deactivation are stored.

NOTE!

The setting in *14-20 Reset Mode* is disregarded if Fire Mode is active (see parameter group 24-0*, Fire Mode).

No:	Description	Critical Alarms	Warranty Affecting Alarms
4	Mains ph. Loss		x
7	DC overvolt	x	
8	DC undervolt	x	
9	Inverter overloaded		x
13	Overcurrent	x	
14	Earth fault	x	
16	Short circuit	x	
29	Power card temp		x
33	Soft-charge fault		x
38	Internal fault		x
65	Ctrl. card temp		x
68	SafeStop	x	

Table 3.33

3.22.2 24-1* Drive Bypass

The Adjustable frequency drive includes a feature, which can be used to automatically activate an external electro-mechanical bypass in case of a trip/trip lock of the adjustable frequency drive or the event of a Fire Mode Coast (see *24-00 Fire Mode Function*).

The bypass will switch the motor to operation direct on line. The external bypass is activated by means of one of the digital outputs or relays in the Adjustable frequency drive, when programmed in parameter group 5-3* or parameter group 5-4*.

NOTE!

Important! After enabling the Drive Bypass Function, the Adjustable frequency drive is no longer Safety Certified (for using the Safe Stop in versions, where included).

To deactivate the drive bypass at normal operation (fire mode not activated), one of following actions must be carried out:

- Press the Off button on the LCP, (or program two of the digital inputs for Hand On-Off-Auto).
- Activate External Interlock via digital input
- Carry out Power Cycling.

NOTE!

The drive bypass cannot be deactivated if in fire mode. It can be deactivated only by either removing the Fire Mode command signal or the power supply to the Adjustable frequency drive!

When the Drive Bypass function is activated, the display on the LCP will show the status message Drive Bypass. This message has a higher priority than the Fire Mode status messages. When the automatic Drive Bypass function is enabled, it will cut in the external bypass according to the below sequence:

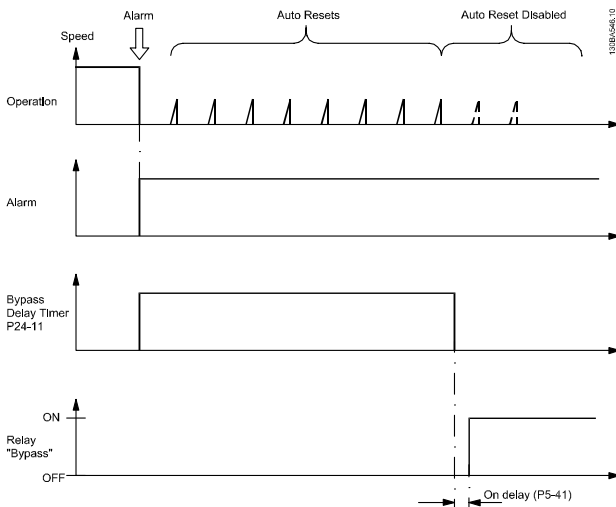

Figure 3.66

Status can be read in the Extended Status Word 2, bit number 24.

24-10 Drive Bypass Function		
Option:	Function:	
		This parameter determines what circumstances will activate the Drive Bypass Function:
[0] *	Disabled	
[1]	Enabled	<p>If in normal operation, the automatic drive bypass function will be activated at following conditions:</p> <p>At a Trip Lock or a Trip. After the programmed number of reset attempts, programmed in 14-20 Reset Mode or if the bypass delay timer (24-11 Drive Bypass Delay Time) expires before reset attempts have been completed</p> <p>When in fire mode, the bypass function will operate under following conditions:</p> <p>When experiencing a trip at critical alarms, a coast or if the bypass delay timer expires before reset attempts have completed when [2] Enabled in fire mode. The bypass function will operate at trip at critical alarms, coast or if the bypass delay timer expires before reset attempts have been completed.</p>
[2]	Enabled (Fire M Only)	The bypass function will operate at trip at critical alarms, coast or bypass delay timer if the timer expires before reset attempts have completed.

CAUTION

Important! After enabling the drive bypass function, the safe stop function (in versions, where included) no longer complies with standard EN 954-1, Cat. 3 installations.

3

24-11 Drive Bypass Delay Time		
Range:	Function:	
0 s* [0 - 600 s]	<p>Programmable in 1 s increments. Once the Bypass Function is activated in accordance with the setting in 24-10 Drive Bypass Function, the Bypass Delay Timer begins to operate. If the Adjustable frequency drive has been set for a number of restart attempts, the timer will continue to run while the Adjustable frequency drive tries to restart. If the motor restarts within the time period of the Bypass Delay Timer, then the timer is reset.</p> <p>Should the motor fail to restart at the end of the Bypass Delay Time, the Drive Bypass relay will be activated, which will have been programmed for Bypass in 5-40 Function Relay. If a [Relay Delay] has also been programmed in 5-41 On Delay, Relay, [Relay] or 5-42 Off Delay, Relay, [Relay], then this time must also elapse before the relay action is performed.</p> <p>Where no restart attempts are programmed, the timer will run for the delay period set in this parameter and will then activate the Drive Bypass relay, which will have been programmed for Bypass in 5-40 Function Relay, Function Relay. If a Relay Delay has also been programmed in 5-41 On Delay, Relay, On Delay, Relay or 5-42 Off Delay, Relay, [Relay], then this time must also elapse before the relay action is performed.</p>	

24-90 Missing Motor Function		
Option:	Function:	
		Select the action to be taken if the motor current is below the limit calculated as a function of the output frequency. The function is used for detecting, e.g., a missing motor in multi-motor applications.
[0] *	Off	
[1]	Warning	

24-91 Missing Motor Coefficient 1		
Range:	Function:	
0.0000 * [-10.0000 - 10.0000]	Enter the cubic coefficient of the Missing Motor detection function multiplied by 1,000.	

24-92 Missing Motor Coefficient 2		
Range:	Function:	
0.0000 * [-100.0000 - 100.0000]	Enter the quadratic coefficient of the Missing Motor detection function multiplied by 1,000.	

24-93 Missing Motor Coefficient 3		
Range:	Function:	
0.0000 * [-100.0000 - 100.0000]	Enter the linear coefficient of the Missing Motor detection function.	

24-94 Missing Motor Coefficient 4		
Range:	Function:	
0.000 * [-500.000 - 500.000]	Enter the constant of the Missing Motor detection function.	

24-95 Locked Rotor Function		
Option:	Function:	
	Select the action to be taken if the motor current is above the limit calculated as a function of the output frequency. The function is used for detecting, e.g., a locked rotor in multi-motor applications.	
[0] *	Off	
[1]	Warning	

24-96 Locked Rotor Coefficient 1		
Range:	Function:	
0.0000 * [-10.0000 - 10.0000]	Enter the cubic coefficient of the Locked Rotor detection function multiplied by 1,000.	

24-97 Locked Rotor Coefficient 2		
Range:	Function:	
0.0000 * [-100.0000 - 100.0000]	Enter the quadratic coefficient of the Locked Rotor detection function multiplied by 1,000.	

24-98 Locked Rotor Coefficient 3		
Range:	Function:	
0.0000 * [-100.0000 - 100.0000]	Enter the linear coefficient of the Locked Rotor detection function.	

24-99 Locked Rotor Coefficient 4		
Range:	Function:	
0.000 * [-500.000 - 500.000]	Enter the constant of the Locked Rotor detection function.	

3.23 Main Menu - Cascade Controller - Group 25

Parameters for configuring the Basic Cascade Controller for sequence control of multiple pumps. For a more application oriented description and wiring examples, see Chapter *Application Examples*, item *Basic Cascade Controller* in the Design Guide, MG20NXYY.

To configure the Cascade Controller to the actual system and the desired control strategy, it is recommended to follow the below sequence, starting with parameter group 25-0* *System Settings* and next parameter group 25-5* *Alternation Settings*. These parameter can normally be set in advance.

Parameters in 25-2* *Bandwidth Settings* and 25-4* *Staging settings*, will often be dependent on the dynamics of the system and final adjustment to be done at the commissioning of the plant.

NOTE!

The Cascade Controller is supposed to operate in closed-loop controlled by the built-in PI controller (Closed-loop selected in 1-00 Configuration Mode). If *Open-loop* is selected in 1-00 Configuration Mode, all fixed-speed pumps will be destaged, but the variable-speed pump will still be controlled by the Adjustable frequency drive now as an open-loop configuration:

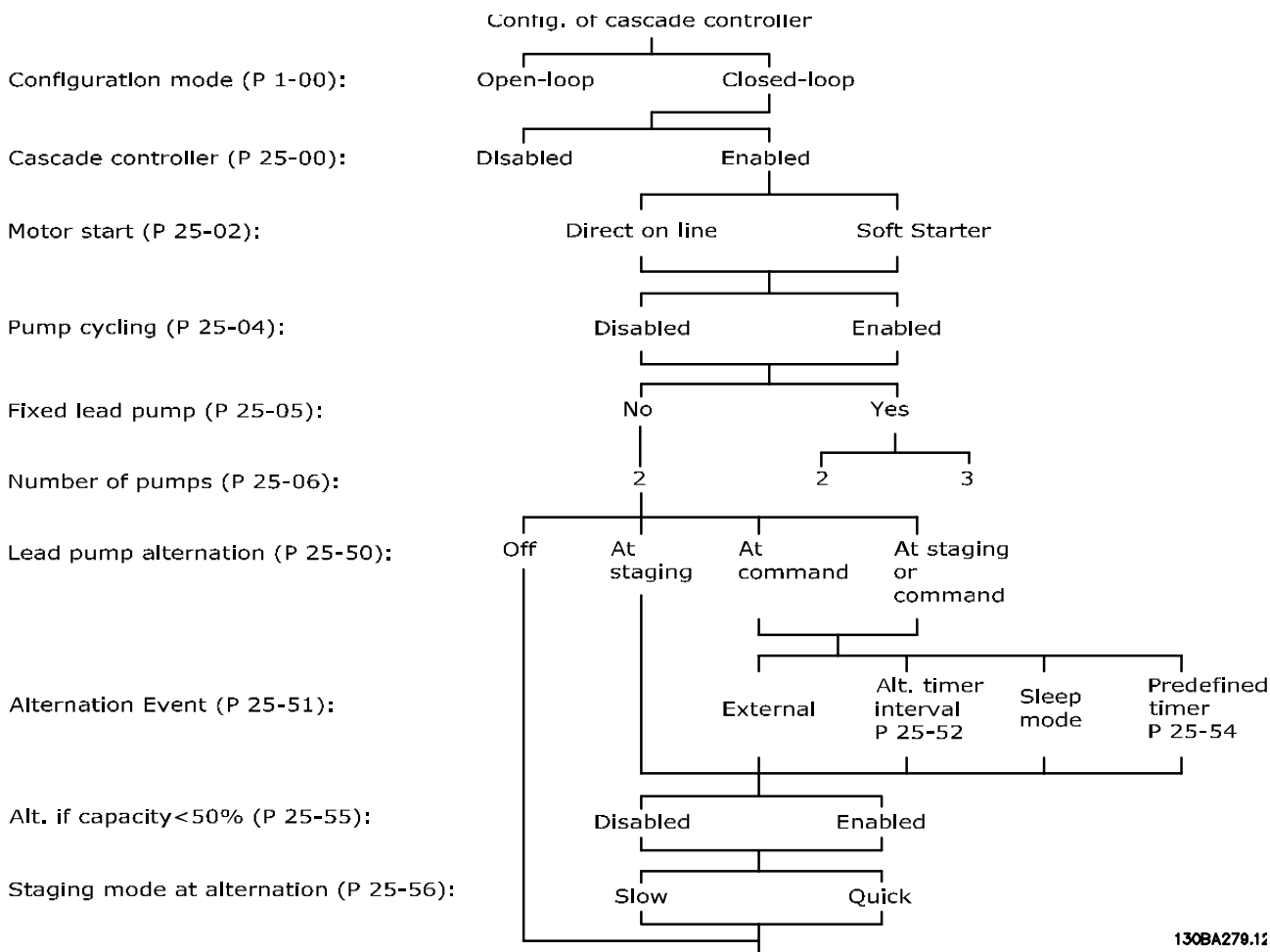

130BA279.12

Figure 3.67

3.23.1 25-0* System Settings

Parameters related to control principles and configuration of the system.

25-00 Cascade Controller		
Option:	Function:	
		For operation of multiple devices (pump/fan) systems where capacity is adapted to actual load by means of speed control combined with on/off control of the devices. For simplicity, only pump systems are described.
[0] *	Disabled	The Cascade Controller is not active. All built-in relays assigned to pump motors in the cascade function will be de-energized. If a variable-speed pump is connected to the Adjustable frequency drive directly (not controlled by a built-in relay); this pump/fan will be controlled as a single pump system.
[1]	Enabled	The cascade controller is active and will stage/destage pumps according to load on the system.

25-02 Motor Start		
Option:	Function:	
		Motors are directly connected to the line power with a contactor or a soft starter. When the value of <i>25-02 Motor Start</i> is set to an option other than <i>Direct on Line</i> [0], then <i>25-50 Lead Pump Alternation</i> is automatically set to the default of <i>Direct on Line</i> [0].
[0] *	Direct on Line	Each fixed speed pump is directly connected to line via a contactor.
[1]	Soft Starter	Each fixed speed pump is connected to line via a soft starter.
[2]	Star-Delta	

25-04 Pump Cycling		
Option:	Function:	
		To provide equal hours of operation with fixed-speed pumps, the pump use can be cycled. The selection of pump cycling is either "first in – last out" or equal running hours for each pump.
[0] *	Disabled	The fixed-speed pumps will be connected in the order 1 – 2 and disconnected in the order 2 – 1. (First in – last out).
[1]	Enabled	The fixed-speed pumps will be connected/disconnected to have equal running hours for each pump.

25-05 Fixed Lead Pump		
Option:	Function:	
		Fixed Lead Pump means that the variable-speed pump is connected directly to the Adjustable frequency drive and if a contactor is applied between Adjustable frequency drive and pump, this contactor will not be controlled by the Adjustable frequency drive. If operating with <i>25-50 Lead Pump Alternation</i> set to other than <i>Off</i> [0], this parameter must be set to <i>No</i> [0].
[0]	No	The lead pump function can alternate between the pumps controlled by the two built in relays. One pump must be connected to the built-in RELAY 1, and the other pump to RELAY 2. The pump function (Cascade Pump1 and Cascade Pump2) will automatically be assigned to the relays (maximum two pumps can in this case be controlled from the Adjustable frequency drive).
[1] *	Yes	The lead pump will be fixed (no alternation) and connected directly to the Adjustable frequency drive. The <i>25-50 Lead Pump Alternation</i> is automatically set to <i>Off</i> [0]. Built-in relays Relay 1 and Relay 2 can be assigned to separate fixed-speed pumps. In total three pumps can be controlled by the Adjustable frequency drive.

25-06 Number Of Pumps		
Range:	Function:	
2 *	[2 - 9.]	The number of pumps connected to the Cascade Controller including the variable speed pump. If the variable-speed pump is connected directly to the Adjustable frequency drive and the other fixed-speed pumps (lag pumps) are controlled by the two built-in relays, three pumps can be controlled. If both the variable-speed and fixed-speed pumps are to be controlled by built-in relays, only two pumps can be connected. If <i>25-05 Fixed Lead Pump</i> , is set to <i>No</i> [0]: one variable-speed pump and one fixed-speed pump; both controlled by built-in relay. If <i>25-05 Fixed Lead Pump</i> is set to <i>Yes</i> [1]: one variable-speed pump and one fixed-speed pump controlled by built-in relay. One lead pump, see <i>25-05 Fixed Lead Pump</i> . Two fixed-speed pumps controlled by built-in relays.

3.23.2 25-2* Bandwidth Settings

Parameters for setting the bandwidth within which the pressure will be allowed to operate before staging/de-staging fixed-speed pumps. Also includes various timers to stabilize the control.

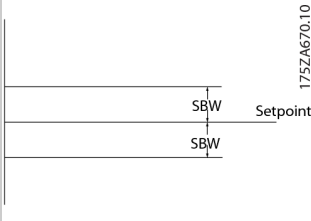
25-20 Staging Bandwidth		
Range:	Function:	
10 %*	[1 - par. 25-21 %]	<p>Set the staging bandwidth (SBW) percentage to accommodate normal system pressure fluctuation.</p> <p>In cascade control systems, to avoid frequent switching of fixed-speed pumps, the desired system pressure is typically kept within a bandwidth rather than at a constant level.</p> <p>The SBW is programmed as a percentage of <i>20-13 Minimum Reference/Feedb.</i> and <i>20-14 Maximum Reference/Feedb.</i>. For example, if the setpoint is 5 bar and the SBW is set to 10%, a system pressure between 4.5 and 5.5 bar is tolerated. No staging or de-staging will occur within this bandwidth.</p>
		 <p style="text-align: right; font-size: small;">175ZA670.10</p>
		<p>Figure 3.69</p>

25-21 Override Bandwidth		
Range:	Function:	
100 %*	[par. 25-20 - 100 %]	<p>When a large and quick change in the system demand occurs (such as a sudden water demand), the system pressure rapidly changes and an immediate staging or de-staging of a fixed-speed pump becomes necessary to match the requirement. The override bandwidth (OBW) is programmed to override the staging/de-staging timer (<i>25-23 SBW Staging Delay</i> and <i>25-24 SBW De-staging Delay</i>) for immediate response.</p> <p>The OBW must always be programmed to a higher value than the value set in <i>Staging Bandwidth (SBW)</i>, <i>25-20 Staging Bandwidth</i>. The OBW is a percentage of and .</p>

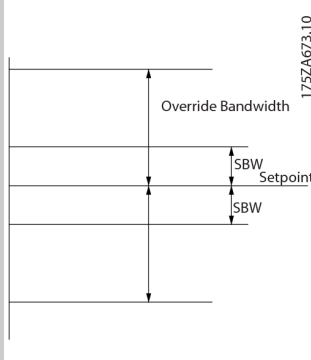
25-21 Override Bandwidth		
Range:	Function:	
		 <p style="text-align: right; font-size: small;">175ZA673.10</p>
		<p>Figure 3.71</p> <p>Setting the OBW too close to the SBW could defeat the purpose with frequent staging at momentary pressure changes. Setting the OBW too high might lead to unacceptably high or low pressure in the system while the SBW timers are running. The value can be optimized with increased familiarity with the system. See <i>25-25 OBW Time</i>.</p> <p>To avoid unintended staging during the commissioning phase and fine tuning of the controller, initially leave the OBW at the factory setting of 100% (Off). When the fine tuning is completed, the OBW should be set to the desired value. An initial value of 10% is suggested.</p>

25-22 Fixed Speed Bandwidth		
Range:	Function:	
Size related*	[par. 25-20 - par. 25-21 %]	When the cascade control system is running normally and the Adjustable frequency drive issues a trip alarm, it is important to maintain the system head. The Cascade Controller does this by continuing to stage/destage the fixed-speed pump on and off. Due to the fact that keeping the head at the setpoint would require frequent staging and de-staging when only a fixed-speed pump is running, a wider Fixed-speed Bandwidth (FSBW) is used instead of SBW. It is possible to stop the fixed-speed pumps, in case of an alarm situation, by pressing the LCP OFF or HAND ON keys or if the signal programmed for Start on digital input goes low. If the issued alarm is a trip-lock alarm, the cascade controller must stop the system immediately by cutting out all the fixed-speed pumps. This is basically the same as Emergency Stop (Coast/Coast inverse Command) for the cascade controller.

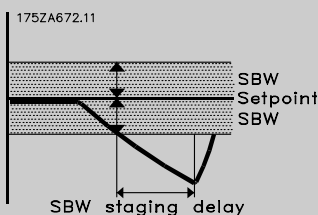
25-23 SBW Staging Delay		
Range:	Function:	
15 s*	[1 - 3000 s]	Immediate staging of a fixed-speed pump is not desirable when a momentary pressure drop in the system exceeds the staging bandwidth (SBW). Staging is delayed by the length of time programmed. If the pressure increases to within the SBW before the timer has elapsed, the timer is reset. 

25-24 SBW De-staging Delay		
Range:	Function:	
15 s*	[0 - 3000 s]	Immediate de-staging of a fixed-speed pump is not desirable during a momentary pressure increase in the system that exceeds the staging bandwidth (SBW). De-staging is delayed by the length of time programmed. If the pressure decreases to within the SBW before the timer has elapsed, the timer is reset.

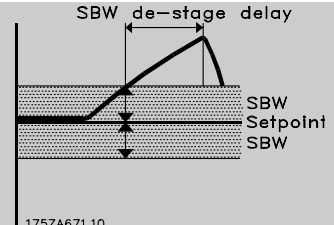
25-24 SBW De-staging Delay		
Range:	Function:	
		

25-25 OBW Time		
Range:	Function:	
10 s*	[0 - 300 s]	Staging a fixed-speed pump creates a momentary pressure peak in the system, which might exceed the Override Bandwidth (OBW). It is not desirable to destage a pump in response to a staging pressure peak. The OBW time can be programmed to prevent staging until the system pressure has stabilized and normal control has been established. Set the timer to a value that allows the system to stabilize after staging. The 10 second factory setting is appropriate in most applications. In highly dynamic systems, a shorter time may be desirable.

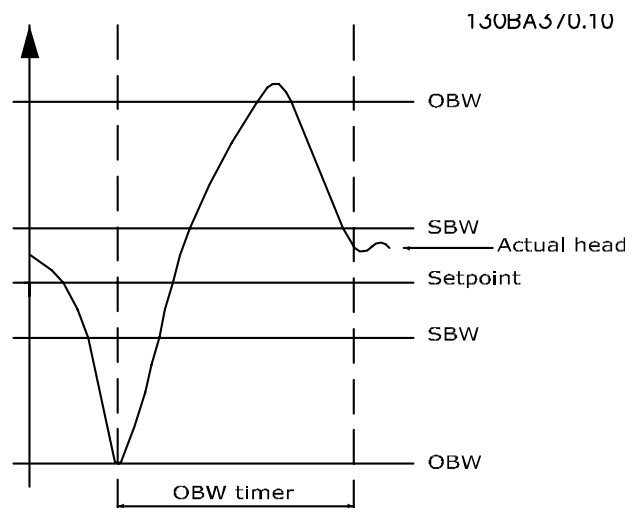

Figure 3.74

25-26 Destage At No-Flow		
Option:	Function:	
		The de-stage at the no-flow parameter ensures that when a no-flow situation occurs, the fixed speed pumps will be de-staged one-by-one until the no-flow signal disappears. This requires that no-flow detection is active. See parameter group 22-2*. If De-stage at No-Flow is disabled the Cascade Controller does not change the normal behavior of the system.
[0] *	Disabled	
[1]	Enabled	

25-27 Stage Function		
Option:	Function:	
		If the stage function is set to <i>Disabled</i> [0], <i>25-28 Stage Function Time</i> will not be activated.
[0]	Disabled	
[1]	Enabled	

25-28 Stage Function Time		
Range:	Function:	
15 s*	[0 - 300 s]	Stage function time is programmed to avoid frequent staging of the fixed speed pumps. The stage function time starts if it is <i>Enabled</i> [1] by <i>25-27 Stage Function</i> , and when the variable speed pump is running at <i>Motor Speed High Limit</i> , <i>4-13 Motor Speed High Limit [RPM]</i> or <i>4-14 Motor Speed High Limit [Hz]</i> , with at least one fixed speed pump in the stop position. When the programmed value of the timer expires, a fixed speed pump is staged.

25-29 Destage Function		
Option:	Function:	
		The Destage Function ensures that the lowest numbers of pumps are running to save energy and to avoid dead head water circulation in the variable speed pump. If the Destage Function is set to <i>Disabled</i> [0], the <i>25-30 Destage Function Time</i> will not be activated.
[0]	Disabled	
[1]	Enabled	

25-30 Destage Function Time		
Range:	Function:	
15 s*	[0 - 300 s]	The Destage Function Timer is programmable to avoid frequent staging/destaging of the fixed-speed pumps. The Destage Function Time starts when the adjustable speed pump is running at <i>4-11 Motor Speed Low Limit [RPM]</i> or <i>4-12 Motor Speed Low Limit [Hz]</i> , with one or more fixed-speed pumps in operation and system requirements satisfied. In this situation, the adjustable speed pump contributes a little to the system. When the programmed value of the timer expires, a stage is removed, avoiding dead head water circulation in the adjustable speed pump.

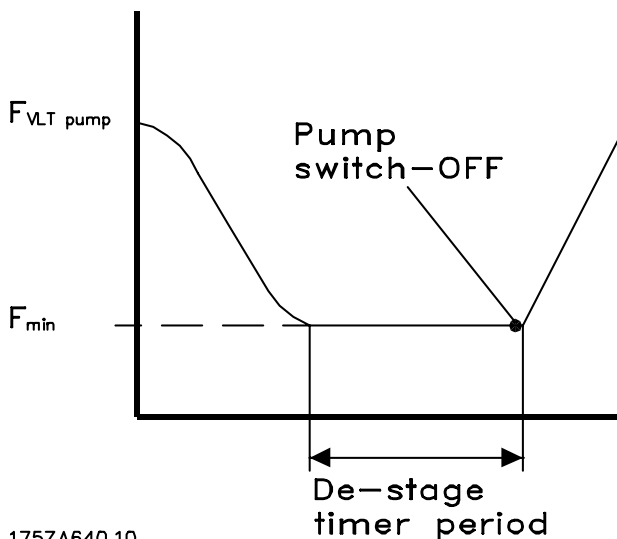
 175ZA640.10
 Figure 3.75

3.23.3 25-4* Staging Settings

Parameters determining conditions for staging/de-staging the pumps.

25-40 Ramp-down Delay		
Range:	Function:	
10.0 s*	[0.0 - 120.0 s]	When adding a fixed-speed pump controlled by a soft starter, it is possible to delay the ramp-down of the lead pump until a preset time after the start of the fixed-speed pump to eliminate pressure surges or water hammer in the system. Only to be used if <i>Soft Starter</i> [1] is selected in <i>25-02 Motor Start</i> .

25-41 Ramp-up Delay		
Range:	Function:	
2.0 s*	[0.0 - 12.0 s]	When removing a fixed-speed pump controlled by a soft starter, it is possible to delay the ramp-up of the lead pump until a preset time after the stopping of the fixed-speed pump to eliminate pressure surges or water hammer in the system. Only to be used if <i>Soft Starter</i> [1] is selected in <i>25-02 Motor Start</i> .

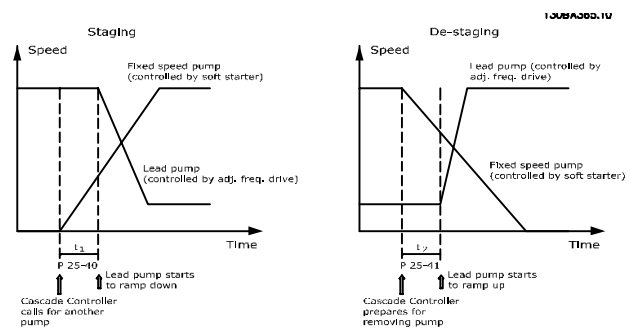

Figure 3.76

25-42 Staging Threshold		
Range:	Function:	
Size related*	[0 - 100 %]	When adding a fixed-speed pump, in order to prevent an overshoot of pressure, the variable-speed pump ramps down to a lower speed. When the variable-speed pump reaches the "Staging Speed", the fixed-speed pump is staged on. The Staging Threshold is used to calculate the speed of the variable-speed pump when the "cut-in point" of the fixed-speed pump occurs. The calculation of the staging threshold is the ratio of <i>4-11 Motor Speed Low Limit [RPM]</i> or <i>4-12 Motor Speed Low Limit [Hz]</i> , to the <i>4-13 Motor Speed High Limit [RPM]</i> or <i>4-14 Motor Speed High Limit [Hz]</i> , expressed in percent. Staging Threshold must range from $STAGE\% = \frac{LOW}{HIGH} \times 100\%$ to 100%, where n_{LOW} is Motor Speed Low Limit and n_{HIGH} is Motor Speed High Limit.

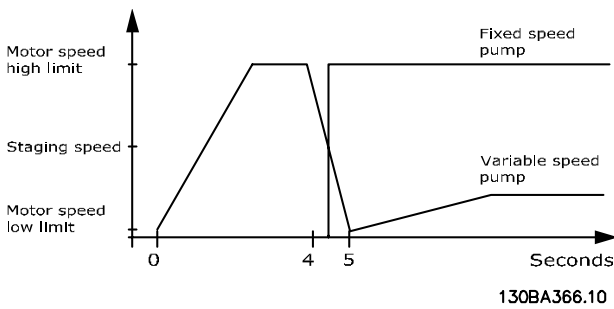

Figure 3.77

130BA366.10

NOTE!

If the setpoint is reached after staging before the variable-speed pump reaches its maximum speed, the system will enter the closed-loop state as soon as the feedback pressure crosses the setpoint.

25-43 De-staging Threshold	
Range:	Function:
Size related* [0 - 100 %]	When removing a fixed-speed pump, in order to prevent an undershoot of pressure, the variable-speed pump ramps up to a higher speed. When the variable-speed pump reaches the "De-staging Speed," the fixed-speed pump is de-staged. The De-staging threshold is used to calculate the speed of the variable-speed pump when the de-staging of the fixed-speed pump occurs. The calculation of the De-staging threshold is the ratio of 4-11 Motor Speed Low Limit [RPM] or 4-12 Motor Speed Low Limit [Hz], to the 4-13 Motor Speed High Limit [RPM] or 4-14 Motor Speed High Limit [Hz], expressed in percent. De-staging Threshold must range from $STAGE\% = \frac{LOW}{HIGH} \times 100\%$ to 100%, where n_{LOW} is Motor Speed Low Limit and n_{HIGH} is Motor Speed High Limit.

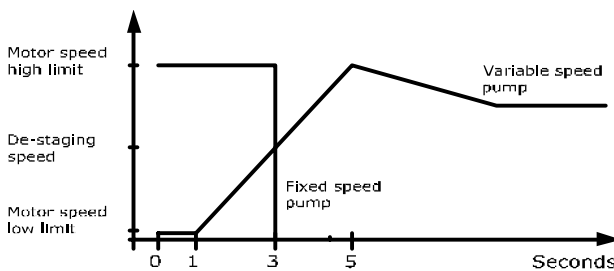

Figure 3.78

130BA367.10

NOTE!

If the setpoint is reached after staging before the variable-speed pump reaches its maximum speed, the system will enter the closed-loop state as soon as the feedback pressure crosses the setpoint.

25-44 Staging Speed [RPM]	
Range:	Function:
0 RPM* [0 - 0 RPM]	Readout of the value calculated below for Staging Speed When adding a fixed-speed pump, in order to prevent an overshoot of pressure, the variable-speed pump ramps down to a lower speed. When the variable-speed pump reaches the "Staging Speed", the fixed-speed pump is staged on. Staging Speed calculation is based on 25-42 Staging Threshold, and 4-13 Motor Speed High Limit [RPM]. Staging Speed is calculated with the following formula: $STAGE = HIGH \frac{STAGE\%}{100}$ where n_{HIGH} is Motor Speed High Limit and $n_{STAGE100\%}$ is the value of Staging Threshold.

25-45 Staging Speed [Hz]	
Range:	Function:
0.0 Hz* [0.0 - 0.0 Hz]	Readout of the value calculated below for Staging Speed When adding a fixed-speed pump, in order to prevent an overshoot of pressure, the variable-speed pump ramps down to a lower speed. When the variable-speed pump reaches the "Staging Speed", the fixed-speed pump is staged on. Staging Speed calculation is based on 25-42 Staging Threshold, and 4-14 Motor Speed High Limit [Hz]. Staging Speed is calculated with the following formula: $STAGE = HIGH \frac{STAGE\%}{100}$ where n_{HIGH} is Motor Speed High Limit and $n_{STAGE100\%}$ is the value of Staging Threshold.

3

25-46 De-staging Speed [RPM]		
Range:	Function:	
0 RPM*	[0 - 0 RPM]	<p>Readout of the value calculated below for De-staging Speed. When removing a fixed-speed pump, in order to prevent an undershoot of pressure, the variable-speed pump ramps up to a higher speed. When the variable-speed pump reaches the "De-staging Speed," the fixed-speed pump is de-staged. De-staging Speed is calculated based on 25-43 De-staging Threshold, and 4-13 Motor Speed High Limit [RPM].</p> <p>De-staging Speed is calculated with the following formula:</p> $DESTAGE = HIGH \frac{DESTAGE\%}{100}$ <p>where n_{HIGH} is Motor Speed High Limit and n_{DESTAGE100%} is the value of De-staging Threshold.</p>

25-47 De-staging Speed [Hz]		
Range:	Function:	
0.0 Hz*	[0.0 - 0.0 Hz]	<p>Readout of the value calculated below for De-staging Speed. When removing a fixed-speed pump, in order to prevent an undershoot of pressure, the variable-speed pump ramps up to a higher speed. When the variable-speed pump reaches the "De-staging Speed," the fixed-speed pump is de-staged. De-staging Speed is calculated based on 25-43 De-staging Threshold, and 4-14 Motor Speed High Limit [Hz].</p> <p>De-staging Speed is calculated with the following formula:</p> $DESTAGE = HIGH \frac{DESTAGE\%}{100}$ <p>where n_{HIGH} is Motor Speed High Limit and n_{DESTAGE100%} is the value of De-staging Threshold.</p>

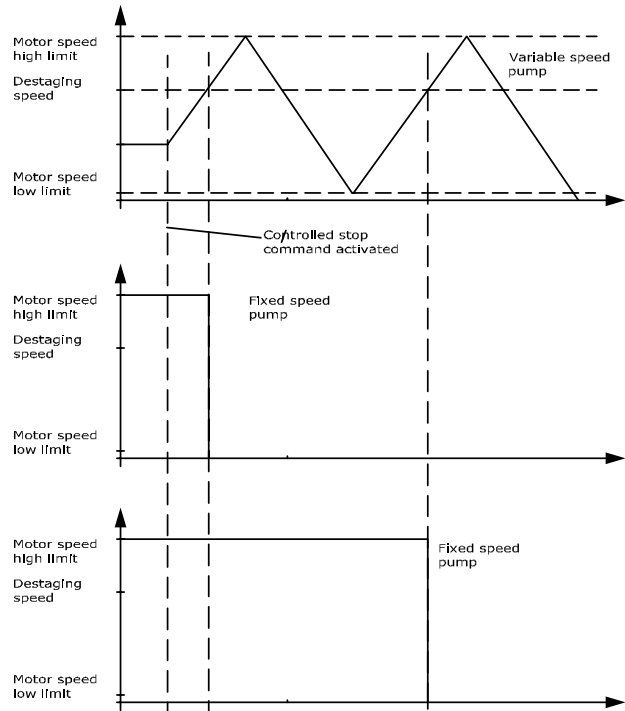

130BA368.10

Figure 3.79

3.23.4 25-5* Alternation Settings

Parameters for defining the conditions for alternation of the variable-speed pump (lead), if selected as part of the control strategy.

25-50 Lead Pump Alternation		
Option:	Function:	
		Lead pump alternation equalizes the use of pumps by periodically changing the pump that is speed controlled. This ensures that pumps are equally used over time. Alternation equalizes the usage of pumps by always choosing the pump with the lowest number of used hours to stage on next.
[0] *	OFF	No alternation of lead pump function will take place. It is not possible to set this parameter to options other than <i>Off</i> [0] if <i>25-02 Motor Start</i> is set other than <i>Direct on Line</i> [0].
[1]	At staging	Alternation of the lead pump function will take place when staging another pump.
[2]	At command	Alternation of the lead pump function will take place at an external command signal or a pre-programmed event. See <i>25-51 Alternation Event</i> for available options.
[3]	At staging or com.	Alternation of the variable-speed (lead) pump will take place at staging or the "At Command" signal. (See above.)

NOTE!

It is not possible to select other than *Off* [0] if *25-05 Fixed Lead Pump* is set to *Yes* [1].

25-51 Alternation Event		
Option:	Function:	
		This parameter is only active if the options <i>At Command</i> [2] or <i>At Staging or Command</i> [3] have been selected in <i>25-50 Lead Pump Alternation</i> . If an alternation event is selected, the alternation of lead pump takes place every time the event occurs.
[0] *	External	Alternation takes place when a signal is applied to one of the digital inputs on the terminal strip and this input has been assigned to <i>Lead Pump Alternation</i> [121] in <i>parameter group 5-1*, Digital Inputs</i> .
[1]	Alternation Time Interval	Alternation takes place every time <i>25-52 Alternation Time Interval</i> expires.
[2]	Sleep Mode	Alternation takes place each time the lead pump goes into sleep mode. <i>20-23 Setpoint 3</i> must be set to <i>Sleep Mode</i> [1] or an external signal applied for this function.
[3]	Predefined Time	Alternation takes place at a defined time of the day. If <i>25-54 Alternation Predefined Time</i> is set, the alternation is carried out every day at

25-51 Alternation Event		
Option:	Function:	
		the specified time. Default time is midnight (00:00 or 12:00 AM depending on the time format).

25-52 Alternation Time Interval		
Range:	Function:	
24 h* [1 - 999 h]		If <i>Alternation Time Interval</i> [1] option in <i>25-51 Alternation Event</i> is selected, the alternation of the variable speed pump takes place every time the <i>Alternation Time Interval</i> expires (can be checked out in <i>25-53 Alternation Timer Value</i>).

25-53 Alternation Timer Value		
Range:	Function:	
0* [0 - 0]		Readout parameter for the <i>Alternation Time Interval</i> value set in <i>25-52 Alternation Time Interval</i> .

25-54 Alternation Predefined Time		
Range:	Function:	
Size related*	[0 - 0]	

25-55 Alternate if Load < 50%		
Option:	Function:	
		If <i>Alternation If Capacity < 50%</i> is enabled, the pump alternation can only occur if the capacity is equal to or below 50%. The capacity calculation is the ratio of running pumps (including the variable speed pump) to the total number of available pumps (including variable speed pump, but not those interlocked). $Capacity = \frac{N_{RUNNING}}{N_{TOTAL}} \times 100\%$ For the Basic Cascade Controller, all pumps are equal size.
[0]	Disabled	The lead pump alternation will take place at any pump capacity.
[1] *	Enabled	The lead pump function will be alternated only if the numbers of pumps running are providing less than 50% of total pump capacity.

NOTE!

Only valid if *25-50 Lead Pump Alternation* is different from *Off* [0].

25-56 Staging Mode at Alternation		
Option:	Function:	
		This parameter is only active if the option selected in 25-50 <i>Lead Pump Alternation</i> is different from <i>Off</i> [0]. Two types of staging and de-staging of pumps are possible. Slow transfer makes staging and de-staging smooth. Quick transfer makes staging and destaging as fast as possible; the variable-speed pump is just cut out (coasted).
[0] *	Slow	At alternation, the variable-speed pump is ramped up to maximum speed and then ramped down to a stand still.
[1]	Quick	At alternation, the variable-speed pump is ramped up to maximum speed and then coasted to stand still.

The figure below is an example of slow transfer staging. The variable-speed pump (top graph) and one fixed-speed pump (bottom graph) are running before the staging command. When the *Slow* [0] transfer command is activated, an alternation is carried out by ramping the variable-speed pump to 4-13 *Motor Speed High Limit [RPM]* or 4-14 *Motor Speed High Limit [Hz]*, and then decelerated to zero speed. After a "Delay Before Starting Next Pump" (25-58 *Run Next Pump Delay*), the next lead pump (middle graph) is accelerated and another original lead pump (top graph) is added after the "Delay Before Running On Line Power" (25-59 *Run-on Line Delay*) as a fixed-speed pump. The next lead pump (middle graph) is decelerated to Motor Speed Low Limit and then allowed to vary speed to maintain system pressure.

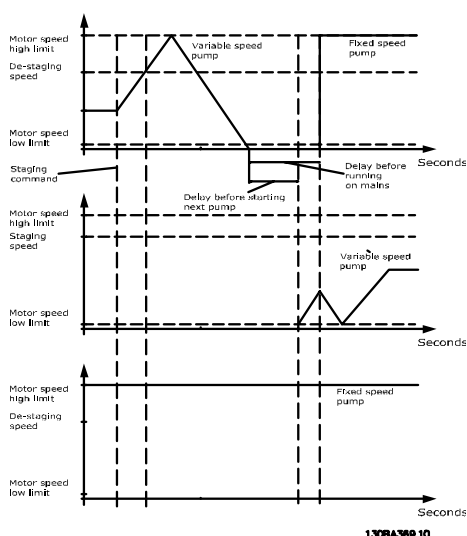

Figure 3.80

25-58 Run Next Pump Delay		
Range:	Function:	
0.1 s* [0.1 - 5.0 s]		This parameter is only active if the option selected in 25-50 <i>Lead Pump Alternation</i> , is different from <i>Off</i> [0]. This parameter sets the time between stopping the old variable speed pump and starting another pump as a new variable speed pump. Refer to 25-56 <i>Staging Mode at Alternation</i> , the figure for description of staging and alternation.

25-59 Run-on Line Delay		
Range:	Function:	
0.5 s* [par. 25-58 - 5.0 s]		This parameter is only active if the option selected in 25-50 <i>Lead Pump Alternation</i> , is different from <i>Off</i> [0]. This parameter sets the time between stopping the old variable-speed pump and starting this pump as a new fixed-speed pump. Refer to Figure 3.80 for description of staging and alternation.

3.23.5 25-8* Status

Readout parameters informing about the operating status of the Cascade Controller and the pumps controlled.

25-80 Cascade Status		
Range:	Function:	
0 *	[0 - 0]	Readout of the status of the Cascade Controller.

25-81 Pump Status		
Range:	Function:	
0 *	[0 - 0]	Pump status shows the status for the number of pumps selected in 25-06 <i>Number Of Pumps</i> . It is a readout of the status for each of the pumps showing a string, which consists of pump number and the current status of the pump. Example: Readout is with the abbreviation like "1:D 2:O" This means that pump 1 is running and speed controlled by the Adjustable frequency drive and pump 2 is stopped.

25-82 Lead Pump		
Range:	Function:	
0 * [0 - par. 25-06]	Readout parameter for the actual variable-speed pump in the system. The Lead Pump parameter is updated to reflect the current variable-speed pump in the system when an alternation takes place. If no lead pump is selected (Cascade Controller disabled or all pumps interlocked), the display will show NONE.	

25-83 Relay Status		
Array [2]		
Range:	Function:	
0 * [0 - 0]	Readout of the status for each of the relays assigned to control the pumps. Every element in the array represents a relay. If a relay is activated, the corresponding element is set to "On". If a relay is deactivated, the corresponding element is set to "Off".	

25-84 Pump ON Time		
Array [2]		
Range:	Function:	
0 h* [0 - 2147483647 h]	Readout of the value for pump ON Time. The Cascade Controller has separate counters for the pumps and for the relays that control the pumps. Pump ON Time monitors the "operating hours" of each pump. The value of each Pump ON Time counter can be reset to 0 by writing in the parameter, e.g., if the pump is replaced in case of service.	

25-85 Relay ON Time		
Array [2]		
Range:	Function:	
0 h* [0 - 2147483647 h]	Readout of the value for Relay ON time. The Cascade Controller has separate counters for the pumps and for the relays that control the pumps. Pump cycling is always done based on the relay counters; otherwise, it would always use the new pump if a pump is replaced and its value in 25-84 Pump ON Time is reset. In order to use 25-04 Pump Cycling the Cascade Controller is monitoring the Relay ON time.	

25-86 Reset Relay Counters		
Option:	Function:	
	Resets all elements in 25-85 Relay ON Time counters.	
[0] *	Do not reset	
[1]	Do reset	

3.23.6 25-9* Service

Parameters used in case of service on one or more of the pumps controlled.

25-90 Pump Interlock		
Array [2]		
Option:	Function:	
	In this parameter, it is possible to disable one or more of the fixed-lead pumps. For example, the pump will not be selected for staging on even if it is the next pump in the operation sequence. It is not possible to disable the lead pump with the pump Interlock command. The digital input interlocks are selected as <i>Pump 1-3 Interlock</i> [130 – 132] in <i>parameter group 5-1*</i> , <i>Digital Inputs</i> .	
[0] *	Off	The pump is active for staging/de-staging.
[1]	On	The Pump Interlock command is given. If a pump is running, it is immediately de-staged. If the pump is not running, it is not allowed to stage on.

25-91 Manual Alternation		
Range:	Function:	
0 * [0 - par. 25-06]	Readout parameter for the actual variable-speed pump in the system. The Lead Pump parameter is updated to reflect the current variable-speed pump in the system when an alternation takes place. If no lead pump is selected (Cascade Controller disabled or all pumps interlocked) the display will show NONE.	

3.24 Main Menu - Analog I/O Option MCB 109 - Group 26

The Analog I/O Option MCB 109 extends the functionality of VLT[®] HVAC Drive adjustable frequency drives, by adding a number of additional, programmable analog inputs and outputs. This could be especially useful in building management system installations where the Adjustable frequency drive may be used as decentral I/O, obviating the need for an outstation and thus reducing cost.

Consider the diagram

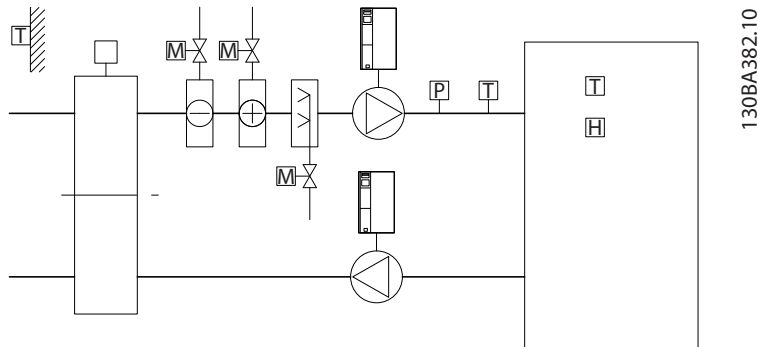

Figure 3.81

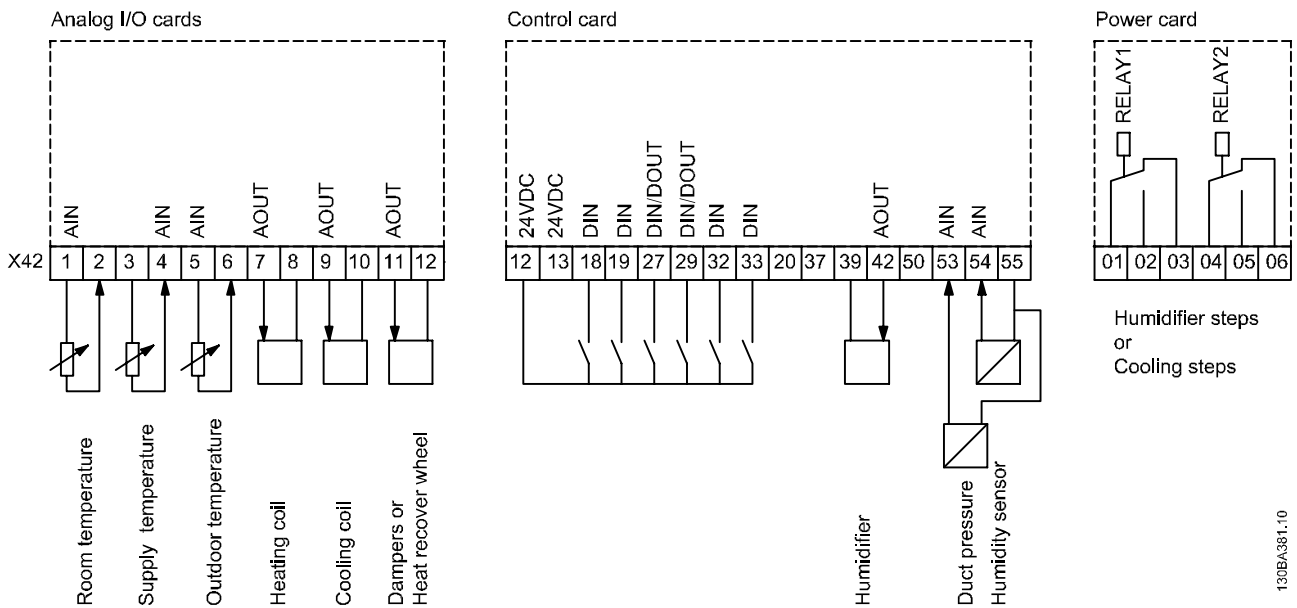

Figure 3.82

This shows a typical Air Handling Unit (AHU). As can be seen, the addition of the Analog I/O option offers the possibility to control all of the functions from the Adjustable frequency drive, such as inlet, return and exhaust dampers or heating/cooling coils with temperature and pressure measurements being read by the Adjustable frequency drive.

NOTE!

The maximum current for the analog outputs 0–10 V is 1 mA.

NOTE!

Where Live Zero Monitoring is used, it is important that any analog inputs not being used for the frequency controller, i.e., being used as part of the building management system decentral I/O, should have their Live Zero function disabled.

Terminal	Parameters	Terminal	Parameters	Terminal	Parameters
Analog inputs		Analog inputs		Relays	
X42/1	26-00 Terminal X42/1 Mode, 26-1*	53	6-1*	Relay 1 Term 1, 2, 3	5-4*
X42/3	26-01 Terminal X42/3 Mode, 26-2*	54	6-2*	Relay 2 Term 4, 5, 6	5-4*
X42/5	26-02 Terminal X42/5 Mode, 26-3*				
Analog outputs		Analog output			
X42/7	26-4*	42	6-5*		
X42/9	26-5*				
X42/11	26-6*				

Table 3.34 Relevant parameters

It is also possible to read the analog inputs, write to the analog outputs and control the relays, using communication via the serial bus. In this instance, these are the relevant parameters.

Terminal	Parameters	Terminal	Parameters	Terminal	Parameters
Analog inputs (read)		Analog inputs (read)		Relays	
X42/1	18-30 Analog Input X42/1	53	16-62 Analog Input 53	Relay 1 Term 1, 2, 3	16-71 Relay Output [bin]
X42/3	18-31 Analog Input X42/3	54	16-64 Analog Input 54	Relay 2 Term 4, 5, 6	16-71 Relay Output [bin]
X42/5	18-32 Analog Input X42/5				
Analog outputs (write)		Analog output (write)		NOTE! The relay outputs must be enabled via Control Word Bit 11 (Relay 1) and Bit 12 (Relay 2).	
X42/7	18-33 Analog Out X42/7 [V]	42	6-53 Terminal 42 Output Bus Control		
X42/9	18-34 Analog Out X42/9 [V]				
X42/11	18-35 Analog Out X42/11 [V]				

Table 3.35 Relevant parameters

Setting of on-board Real Time Clock.

The Analog I/O option incorporates a real time clock with battery backup. This can be used as backup of the clock function included in the Adjustable frequency drive as standard. See 3.2.8 0-7* Clock Settings.

The Analog I/O option can be used for the control of devices such as servos or valves, using the Extended Closed-loop facility, thus removing control from the Building Management System. See 3.19 Main Menu - Extended Closed-loop - Group 21. There are three independent Closed-loop PID controllers.

3.24.1 26-0* Analog I/O Mode

Parameter group for setting up the analog I/O configuration. The option is equipped with 3 analog inputs. These analog inputs can be freely allocated to either voltage (0–+10 V), Pt 1000 or Ni 1000 temperature sensor input.

26-00 Terminal X42/1 Mode		
Option:	Function:	
	Terminal X42/1 can be programmed as an analog input accepting a voltage or input from either Pt1000 (1000 Ω at 0°C) or Ni 1000 (1000 Ω at 0°C) temperature sensors. Select the desired mode. Pt 1000, [2] and Ni 1000 [4] if operating in Celsius - Pt 1000 [3] and Ni 1000 [5] if operating in Fahrenheit. Notice: If the input is not in use, it must be set for voltage! If set for temperature and used as feedback, the unit must be set for either Celsius or Fahrenheit (20-12 Reference/Feedback Unit, 21-10 Ext. 1 Ref./Feedback Unit, 21-30 Ext. 2 Ref./Feedback Unit or 21-50 Ext. 3 Ref./Feedback Unit).	
[1] *	Voltage	
[2]	Pt 1000 [°C]	
[3]	Pt 1000 [°F]	
[4]	Ni 1000 [°C]	
[5]	Ni 1000 [°F]	

26-01 Terminal X42/3 Mode		
Option:	Function:	
	Terminal X42/3 can be programmed as an analog input accepting a voltage or input from either Pt 1000 or Ni 1000 temperature sensors. Select the desired mode. Pt 1000, [2] and Ni 1000, [4] if operating in Celsius - Pt 1000, [3] and Ni 1000, [5] if operating in Fahrenheit. Notice: If the input is not in use, it must be set for voltage! If set for temperature and used as feedback, the unit must be set for either Celsius or Fahrenheit (20-12 Reference/Feedback Unit, 21-10 Ext. 1 Ref./Feedback Unit, 21-30 Ext. 2 Ref./Feedback Unit or 21-50 Ext. 3 Ref./Feedback Unit).	
[1] *	Voltage	
[2]	Pt 1000 [°C]	
[3]	Pt 1000 [°F]	
[4]	Ni 1000 [°C]	
[5]	Ni 1000 [°F]	

26-02 Terminal X42/5 Mode		
Option:	Function:	
	Terminal X42/5 can be programmed as an analog input accepting a voltage or input from either Pt 1000 (1000 Ω at 0° C) or Ni 1000 (1000 Ω at 0° C) temperature sensors. Select the desired mode. Pt 1000, [2] and Ni 1000, [4] if operating in Celsius - Pt 1000, [3] and Ni 1000, [5] if operating in Fahrenheit. Notice: If the input is not in use, it must be set for voltage! If set for temperature and used as feedback, the unit must be set for either Celsius or Fahrenheit (20-12 Reference/Feedback Unit, 21-10 Ext. 1 Ref./Feedback Unit, 21-30 Ext. 2 Ref./Feedback Unit or 21-50 Ext. 3 Ref./Feedback Unit).	
[1] *	Voltage	
[2]	Pt 1000 [°C]	
[3]	Pt 1000 [°F]	
[4]	Ni 1000 [°C]	
[5]	Ni 1000 [°F]	

3.24.2 26-1* Analog Input X42/1

Parameters for configuring the scaling and limits for analog input, terminal X42/1.

26-10 Terminal X42/1 Low Voltage		
Range:	Function:	
0.07 V* [0.00 - par. 6-31 V]	Enter the low voltage value. This analog input scaling value should correspond to the low reference/feedback value set in 26-14 Term. X42/1 Low Ref./Feedb. Value.	

26-11 Terminal X42/1 High Voltage		
Range:	Function:	
10.00 V* [par. 6-30 - 10.00 V]	Enter the high voltage value. This analog input scaling value should correspond to the high reference/feedback value set in 26-15 Term. X42/1 High Ref./Feedb. Value.	

26-14 Term. X42/1 Low Ref./Feedb. Value		
Range:	Function:	
0.000 * [-999999.999 - 999999.999]	Enter the analog input scaling value that corresponds to the low voltage value set in 26-10 Terminal X42/1 Low Voltage.	

26-15 Term. X42/1 High Ref./Feedb. Value		
Range:	Function:	
100.000 * [-999999.999 - 999999.999]	Enter the analog input scaling value that corresponds to the high voltage value set in <i>26-11 Terminal X42/1 High Voltage</i> .	

26-16 Term. X42/1 Filter Time Constant		
Range:	Function:	
0.001 s* [0.001 - 10.000 s]	Enter the time constant. This is a first-order digital low pass filter time constant for suppressing noise in terminal X42/1. A high time constant value improves dampening but also increases the time delay through the filter. This parameter cannot be adjusted while the motor is running.	

26-17 Term. X42/1 Live Zero		
Option:	Function:	
[0]	Disabled	This parameter makes it possible to enable the live zero monitoring, for example where the analog input is a part of the adjustable frequency drive control, rather than being used as part of a decentral I/O system, such as a building management system.
[1] *	Enabled	

3.24.3 26-2* Analog Input X42/3

Parameters for configuring the scaling and limits for analog input, terminal X42/3.

26-20 Terminal X42/3 Low Voltage		
Range:	Function:	
0.07 V* [0.00 - par. 6-31 V]	Enter the low voltage value. This analog input scaling value should correspond to the low reference/feedback value set in <i>26-24 Term. X42/3 Low Ref./Feedb. Value</i> .	

26-21 Terminal X42/3 High Voltage		
Range:	Function:	
10.00 V* [par. 6-30 - 10.00 V]	Enter the high voltage value. This analog input scaling value should correspond to the high reference/feedback value set in <i>26-25 Term. X42/3 High Ref./Feedb. Value</i> .	

26-24 Term. X42/3 Low Ref./Feedb. Value		
Range:	Function:	
0.000 * [-999999.999 - 999999.999]	Enter the analog input scaling value that corresponds to the low voltage value set in <i>26-20 Terminal X42/3 Low Voltage</i> .	

26-25 Term. X42/3 High Ref./Feedb. Value		
Range:	Function:	
100.000 * [-999999.999 - 999999.999]	Enter the analog input scaling value that corresponds to the high voltage value set in <i>26-21 Terminal X42/3 High Voltage</i> .	

26-26 Term. X42/3 Filter Time Constant		
Range:	Function:	
0.001 s* [0.001 - 10.000 s]	Enter the time constant. This is a first-order digital low pass filter time constant for suppressing noise in terminal X42/3. A high time constant value improves dampening but also increases the time delay through the filter. This parameter cannot be adjusted while the motor is running.	

26-27 Term. X42/3 Live Zero		
Option:	Function:	
[0]	Disabled	This parameter makes it possible to enable the live zero monitoring, for example where the analog input is a part of the adjustable frequency drive control, rather than being used as part of a decentral I/O system, such as a building management system.
[1] *	Enabled	

3.24.4 26-3* Analog Input X42/5

Parameters for configuring the scaling and limits for analog input, terminal X42/5.

26-30 Terminal X42/5 Low Voltage		
Range:	Function:	
0.07 V* [0.00 - par. 6-31 V]	Enter the low voltage value. This analog input scaling value should correspond to the low reference/feedback value set in <i>26-34 Term. X42/5 Low Ref./Feedb. Value</i> .	

26-31 Terminal X42/5 High Voltage		
Range:	Function:	
10.00 V* [par. 6-30 - 10.00 V]	Enter the high voltage value. This analog input scaling value should correspond to the high reference/ feedback value set in 26-35 Term. X42/5 High Ref./Feedb. Value.	

26-34 Term. X42/5 Low Ref./Feedb. Value		
Range:	Function:	
0.000 * [-999999.999 - 999999.999]	Enter the analog input scaling value that corresponds to the low voltage value set in 26-30 Terminal X42/5 Low Voltage.	

26-35 Term. X42/5 High Ref./Feedb. Value		
Range:	Function:	
100.000 * [-999999.999 - 999999.999]	Enter the analog input scaling value that corresponds to the high voltage value set in 26-21 Terminal X42/3 High Voltage.	

26-36 Term. X42/5 Filter Time Constant		
Range:	Function:	
0.001 s* [0.001 - 10.000 s]	Enter the time constant. This is a first-order digital low pass filter time constant for suppressing noise in terminal X42/5. A high time constant value improves dampening but also increases the time delay through the filter. This parameter cannot be adjusted while the motor is running.	

26-37 Term. X42/5 Live Zero		
Option:	Function:	
	This parameter makes it possible to enable the live zero monitoring, for example where the analog input is a part of the adjustable frequency drive control, rather than being used as part of a decentral I/O system, such as a building management system.	
[0]	Disabled	
[1] *	Enabled	

3.24.5 26-4* Analog Out X42/7

Parameters for configuring the scaling and output function for analog output, terminal X42/7.

26-40 Terminal X42/7 Output		
Option:	Function:	
	Set the function of terminal X42/7 as an analog voltage output.	
[0] *	No operation	
[100]	Output freq. 0-100	0-100 Hz, (0-20 mA)
[101]	Reference Min-Max	Minimum reference - Maximum reference, (0-20 mA)
[102]	Feedback +-200%	-200% to +200% of 20-14 Maximum Reference/Feedb., (0-20 mA)
[103]	Motor cur. 0-Imax	0 - Inverter Max. Current (16-37 Inv. Max. Current), (0-20 mA)
[104]	Torque 0-Tlim	0 - Torque limit (4-16 Torque Limit Motor Mode), (0-20 mA)
[105]	Torque 0-Tnom	0 - Motor rated torque, (0-20 mA)
[106]	Power 0-Pnom	0 - Motor rated power, (0-20 mA)
[107]	Speed 0-HighLim	0 - Speed High Limit (4-13 Motor Speed High Limit [RPM] and 4-14 Motor Speed High Limit [Hz]), (0-20 mA)
[113]	Ext. Closed-loop 1	0-100%, (0-20 mA)
[114]	Ext. Closed-loop 2	0-100%, (0-20 mA)
[115]	Ext. Closed-loop 3	0-100%, (0-20 mA)
[139]	Bus ctrl.	0-100%, (0-20 mA)
[141]	Bus ctrl t.o.	0-100%, (0-20 mA)

26-41 Terminal X42/7 Min. Scale		
Range:	Function:	
0.00 %*	[0.00 - 200.00 %]	

26-42 Terminal X42/7 Max. Scale		
Range:	Function:	
100.00 %*	[0.00 - 200.00 %]	

See principle graph for 6-52 Terminal 42 Output Max Scale.

26-43 Terminal X42/7 Bus Control		
Range:	Function:	
0.00 %*	[0.00 - 100.00 %]	

26-44 Terminal X42/7 Timeout Preset		
Range:	Function:	
0.00 %*	[0.00 - 100.00 %]	

3.24.6 26-5* Analog Out X42/9

Parameters for configuring the scaling and output function for analog output, terminal X42/9.

26-50 Terminal X42/9 Output		
Option:	Function:	
		Set the function of terminal X42/9.
[0] *	No operation	
[100]	Output freq. 0-100	0–100 Hz, (0–20 mA)
[101]	Reference Min-Max	Minimum reference - Maximum reference, (0–20 mA)
[102]	Feedback +-200%	-200% to +200% of 20-14 Maximum Reference/Feedb., (0–20 mA)
[103]	Motor cur. 0-I _{max}	0 - Inverter Max. Current (16-37 Inv. Max. Current), (0–20 mA)
[104]	Torque 0-Tlim	0 - Torque limit (4-16 Torque Limit Motor Mode), (0–20 mA)
[105]	Torque 0-Tnom	0 - Motor rated torque, (0–20 mA)
[106]	Power 0-Pnom	0 - Motor rated power, (0–20 mA)
[107]	Speed 0-HighLim	0 - Speed High Limit (4-13 Motor Speed High Limit [RPM] and 4-14 Motor Speed High Limit [Hz]), (0–20 mA)
[113]	Ext. Closed-loop 1	0–100%, (0–20 mA)
[114]	Ext. Closed-loop 2	0–100%, (0–20 mA)
[115]	Ext. Closed-loop 3	0–100%, (0–20 mA)
[139]	Bus ctrl.	0–100%, (0–20 mA)
[141]	Bus ctrl t.o.	0–100%, (0–20 mA)

26-51 Terminal X42/9 Min. Scale		
Range:	Function:	
0.00 %*	[0.00 - 200.00 %]	

See principle graph for 6-51 Terminal 42 Output Min Scale.

26-52 Terminal X42/9 Max. Scale		
Range:	Function:	
100.00 %*	[0.00 - 200.00 %]	

See principle graph for 6-52 Terminal 42 Output Max Scale.

26-53 Terminal X42/9 Bus Control		
Range:	Function:	
0.00 %*	[0.00 - 100.00 %]	

26-54 Terminal X42/9 Timeout Preset		
Range:	Function:	
0.00 %*	[0.00 - 100.00 %]	

3.24.7 26-6* Analog Out X42/11

Parameters for configuring the scaling and output function for analog output, terminal X42/11.

26-60 Terminal X42/11 Output		
Option:	Function:	
		Set the function of terminal X42/11.
[0] *	No operation	
[100]	Output freq. 0-100	0–100 Hz, (0–20 mA)
[101]	Reference Min-Max	Minimum reference - Maximum reference, (0–20 mA)
[102]	Feedback +-200%	-200% to +200% of 20-14 Maximum Reference/Feedb., (0–20 mA)
[103]	Motor cur. 0-I _{max}	0 - Inverter Max. Current (16-37 Inv. Max. Current), (0–20 mA)
[104]	Torque 0-Tlim	0 - Torque limit (4-16 Torque Limit Motor Mode), (0–20 mA)
[105]	Torque 0-Tnom	0 - Motor rated torque, (0–20 mA)
[106]	Power 0-Pnom	0 - Motor rated power, (0–20 mA)
[107]	Speed 0-HighLim	0 - Speed High Limit (4-13 Motor Speed High Limit [RPM] and 4-14 Motor Speed High Limit [Hz]), (0–20 mA)
[113]	Ext. Closed-loop 1	0–100%, (0–20 mA)
[114]	Ext. Closed-loop 2	0–100%, (0–20 mA)
[115]	Ext. Closed-loop 3	0–100%, (0–20 mA)
[139]	Bus ctrl.	0–100%, (0–20 mA)
[141]	Bus ctrl t.o.	0–100%, (0–20 mA)

26-61 Terminal X42/11 Min. Scale		
Range:	Function:	
0.00 %*	[0.00 - 200.00 %]	

See principle graph for 6-51 Terminal 42 Output Min Scale.

26-62 Terminal X42/11 Max. Scale		
Range:	Function:	
100.00 %*	[0.00 - 200.00 %]	

See principle graph for 6-52 Terminal 42 Output Max Scale.

26-63 Terminal X42/11 Bus Control		
Range:	Function:	
0.00 %*	[0.00 - 100.00 %]	

26-64 Terminal X42/11 Timeout Preset		
Range:		Function:
0.00 %*	[0.00 - 100.00 %]	

3

4 Troubleshooting

4.1 Troubleshooting

A warning or an alarm is signaled by the relevant LED on the front of the Adjustable frequency drive and indicated by a code on the display.

A warning remains active until its cause is no longer present. Under certain circumstances operation of the motor may still be continued. Warning messages may be critical, but are not necessarily so.

In the event of an alarm, the Adjustable frequency drive will have tripped. Alarms must be reset to restart operation once their cause has been rectified.

This may be done in four ways:

1. By using the [RESET] control button on the LCP.
2. Via a digital input with the "Reset" function.
3. Via serial communication/optional serial communication bus.
4. By resetting automatically using the [Auto Reset] function, which is a default setting for VLT[®] HVAC Drive, see 14-20 Reset Mode in the FC 100 Programming Guide MGxxyy

NOTE!

After a manual reset using the [RESET] button on the LCP, the [Auto On] or [Hand On] button must be pressed to restart the motor.

If an alarm cannot be reset, the reason may be that its cause has not been rectified, or the alarm is trip-locked (see also Table 4.1).

CAUTION

Alarms that are trip-locked offer additional protection, means that the line power supply must be switched off before the alarm can be reset. After being switched back on, the Adjustable frequency drive is no longer blocked and may be reset as described above once the cause has been rectified.

Alarms that are not trip-locked can also be reset using the automatic reset function in 14-20 Reset Mode (Warning: automatic wake-up is possible!)

If a warning and alarm is marked against a code in the table on the following page, this means that either a warning occurs before an alarm, or it can be specified whether it is a warning or an alarm that is to be displayed for a given fault.

This is possible, for instance, in 1-90 Motor Thermal Protection. After an alarm or trip, the motor carries on coasting, and the alarm and warning flash on the Adjustable frequency drive. Once the problem has been rectified, only the alarm continues flashing.

NOTE!

No missing motor phase detection (no 30-32) and no stall detection is active when 1-10 Motor Construction is set to [1] PM non-salient SPM.

No.	Description	Warning	Alarm/Trip	Alarm/Trip Lock	Parameter Reference
1	10 Volts low	X			
2	Live zero error	(X)	(X)		6-01
3	No motor	(X)			1-80
4	Mains phase loss	(X)	(X)	(X)	14-12
5	DC link voltage high	X			
6	DC link voltage low	X			
7	DC overvoltage	X	X		
8	DC undervoltage	X	X		
9	Inverter overloaded	X	X		
10	Motor ETR overtemperature	(X)	(X)		1-90
11	Motor thermistor over temperature	(X)	(X)		1-90
12	Torque limit	X	X		
13	Overcurrent	X	X	X	
14	Earth fault	X	X	X	
15	Hardware mismatch		X	X	

No.	Description	Warning	Alarm/ Trip	Alarm/Trip Lock	Parameter Reference
16	Short Circuit		X	X	
17	Control word timeout	(X)	(X)		8-04
18	Start failed		X		
23	Internal Fan Fault	X			
24	External Fan Fault	X			14-53
25	Brake resistor short-circuited	X			
26	Brake resistor power limit	(X)	(X)		2-13
27	Brake chopper short-circuited	X	X		
28	Brake check	(X)	(X)		2-15
29	Drive overtemperature	X	X	X	
30	Motor phase U missing	(X)	(X)	(X)	4-58
31	Motor phase V missing	(X)	(X)	(X)	4-58
32	Motor phase W missing	(X)	(X)	(X)	4-58
33	Soft-charge fault		X	X	
34	Fieldbus (serial communication bus) fault	X	X		
35	Out of frequency ranges	X	X		
36	Mains failure	X	X		
37	Phase Imbalance	X	X		
38	Internal fault		X	X	
39	Heatsink sensor		X	X	
40	Overload of Digital Output Terminal 27	(X)			5-00, 5-01
41	Overload of Digital Output Terminal 29	(X)			5-00, 5-02
42	Overload of Digital Output On X30/6	(X)			5-32
42	Overload of Digital Output On X30/7	(X)			5-33
46	Pwr. card supply		X	X	
47	24 V supply low	X	X	X	
48	1.8 V supply low		X	X	
49	Speed limit	X	(X)		1-86
50	AMA calibration failed		X		
51	AMA check Unom and Inom		X		
52	AMA low Inom		X		
53	AMA motor too big		X		
54	AMA motor too small		X		
55	AMA Parameter out of range		X		
56	AMA interrupted by user		X		
57	AMA timeout		X		
58	AMA internal fault	X	X		
59	Current limit	X			
60	External Interlock	X			
62	Output Frequency at Maximum Limit	X			
64	Voltage Limit	X			
65	Control Board Over-temperature	X	X	X	
66	Heatsink Temperature Low	X			
67	Option Configuration has Changed		X		
68	Safe Stop	(X)	X ¹⁾		5-19
69	Pwr. Card Temp		X	X	
70	Illegal FC configuration			X	
71	PTC 1 Safe Stop	X	X ¹⁾		
72	Dangerous Failure			X ¹⁾	

No.	Description	Warning	Alarm/ Trip	Alarm/Trip Lock	Parameter Reference
73	Safe Stop Auto Restart				
76	Power Unit Set-up	X			
79	Illegal PS config		X	X	
80	Drive Initialized to Default Value		X		
91	Analog input 54 wrong settings			X	
92	NoFlow	X	X		22-2*
93	Dry Pump	X	X		22-2*
94	End of Curve	X	X		22-5*
95	Broken Belt	X	X		22-6*
96	Start Delayed	X			22-7*
97	Stop Delayed	X			22-7*
98	Clock Fault	X			0-7*
201	Fire M was Active				
202	Fire M Limits Exceeded				
203	Missing Motor				
204	Locked Rotor				
243	Brake IGBT	X	X		
244	Heatsink temp	X	X	X	
245	Heatsink sensor		X	X	
246	Pwr.card supply		X	X	
247	Pwr.card temp		X	X	
248	Illegal PS config		X	X	
250	New spare parts			X	
251	New Type Code		X	X	

Table 4.1 Alarm/Warning code list

(X) Dependent on parameter

1) Cannot be Auto reset via 14-20 Reset Mode

A trip is the action when an alarm has appeared. The trip will coast the motor and can be reset by pressing the reset button or make a reset by a digital input (parameter group 5-1* [1]). The original event that caused an alarm cannot damage the Adjustable frequency drive or cause dangerous conditions. A trip lock is an action when an alarm occurs, which may cause damage to Adjustable frequency drive or connected parts. A trip lock situation can only be reset by power cycling.

LED indication	
Warning	yellow
Alarm	flashing red
Trip locked	yellow and red

Table 4.2

Alarm Word and Extended Status Word					
Bit	Hex	Dec	Alarm Word	Warning Word	Extended Status Word
0	00000001	1	Brake Check	Brake Check	Ramping
1	00000002	2	Pwr. Card Temp	Pwr. Card Temp	AMA Running
2	00000004	4	Earth fault	Ground fault	Start CW/CCW
3	00000008	8	Ctrl.Card Temp	Ctrl.Card Temp	Slow-down
4	00000010	16	Ctrl. Word TO	Ctrl. Word TO	Catch Up
5	00000020	32	Overcurrent	Over Current	Feedback High
6	00000040	64	Torque Limit	Torque Limit	Feedback Low
7	00000080	128	Motor Th Over	Motor Th Over	Output Current High
8	00000100	256	Motor ETR Over	Motor ETR Over	Output Current Low
9	00000200	512	Inverter Overld.	Inverter Overld.	Output Freq High
10	00000400	1024	DC undervolt	DC undervolt	Output Freq Low
11	00000800	2048	DC overvolt	DC overvolt	Brake Check OK
12	00001000	4096	Short Circuit	DC Voltage Low	Braking Max
13	00002000	8192	Soft-charge Fault	DC Voltage High	Braking
14	00004000	16384	Mains ph. Loss	Line ph. Loss	Out of Speed Range
15	00008000	32768	AMA Not OK	No Motor	OVC Active
16	00010000	65536	Live Zero Error	Live Zero Error	
17	00020000	131072	Internal Fault	10 V low	
18	00040000	262144	Brake Overload	Brake Overload	
19	00080000	524288	U phase Loss	Brake Resistor	
20	00100000	1048576	V phase Loss	Brake IGBT	
21	00200000	2097152	W phase Loss	Speed Limit	
22	00400000	4194304	Fieldbus Fault	Serial Communication Bus Fault	
23	00800000	8388608	24 V Supply Low	24V Supply Low	
24	01000000	16777216	Mains Failure	Line Failure	
25	02000000	33554432	1.8V supply low	Current Limit	
26	04000000	67108864	Brake Resistor	Low Temp	
27	08000000	134217728	Brake IGBT	Voltage Limit	
28	10000000	268435456	Option Change	Unused	
29	20000000	536870912	Drive Initialized	Unused	
30	40000000	1073741824	Safe Stop	Unused	
31	80000000	2147483648	Mech. brake low (A63)	Extended Status Word	

Table 4.3 Description of Alarm Word, Warning Word and Extended Status Word

The alarm words, warning words and extended status words can be read out via serial bus or optional serial communication bus for diagnosis. See also *16-90 Alarm Word*, *16-92 Warning Word* and *16-94 Ext. Status Word*.

4.1.1 Alarm Words

16-90 Alarm Word

Bit (Hex)	Alarm Word (16-90 Alarm Word)
00000001	
00000002	Power card over temperature
00000004	Ground fault
00000008	
00000010	Control word timeout
00000020	Over current
00000040	
00000080	Motor thermistor over temp.
00000100	Motor ETR over temperature
00000200	Inverter overloaded
00000400	DC link under voltage
00000800	DC link over voltage
00001000	Short circuit
00002000	
00004000	Line phase loss
00008000	AMA not OK
00010000	Live zero error
00020000	Internal fault
00040000	
00080000	Motor phase U is missing
00100000	Motor phase V is missing
00200000	Motor phase W is missing
00800000	Control Voltage Fault
01000000	
02000000	VDD, supply low
04000000	Brake resistor short circuit
08000000	Brake chopper fault
10000000	Ground fault DESAT
20000000	Drive initialized
40000000	Safe Stop [A68]
80000000	

Table 4.4

16-91 Alarm word 2

Bit (Hex)	Alarm Word 2 (16-91 Alarm word 2)
00000001	
00000002	Reserved
00000004	Service Trip, Type code / Spare part
00000008	Reserved
00000010	Reserved
00000020	
00000040	
00000080	
00000100	Broken Belt
00000200	Not used
00000400	Not used
00000800	Reserved
00001000	Reserved
00002000	Reserved
00004000	Reserved
00008000	Reserved
00010000	Reserved
00020000	Not used
00040000	Fans error
00080000	ECB error
00100000	Reserved
00200000	Reserved
00400000	Reserved
00800000	Reserved
01000000	Reserved
02000000	Reserved
04000000	Reserved
08000000	Reserved
10000000	Reserved
20000000	Reserved
40000000	PTC 1 Safe Stop [A71]
80000000	Dangerous Failure [A72]

Table 4.5

4.1.2 Warning Words

16-92 Warning Word

Bit (Hex)	Warning Word (16-92 Warning Word)
00000001	
00000002	Power card over temperature
00000004	Ground fault
00000008	
00000010	Control word timeout
00000020	Over current
00000040	
00000080	Motor thermistor over temp.
00000100	Motor ETR over temperature
00000200	Inverter overloaded
00000400	DC link under voltage
00000800	DC link over voltage
00001000	
00002000	
00004000	Line phase loss
00008000	No motor
00010000	Live zero error
00020000	
00040000	
00080000	
00100000	
00200000	
00400000	
00800000	
01000000	
02000000	Current limit
04000000	
08000000	
10000000	
20000000	
40000000	Safe Stop [W68]
80000000	Not used

Table 4.6

16-93 Warning word 2

Bit (Hex)	Warning Word 2 (16-93 Warning word 2)
00000001	
00000002	
00000004	Clock Failure
00000008	Reserved
00000010	Reserved
00000020	
00000040	
00000080	End of Curve
00000100	Broken Belt
00000200	Not used
00000400	Reserved
00000800	Reserved
00001000	Reserved
00002000	Reserved
00004000	Reserved
00008000	Reserved
00010000	Reserved
00020000	Not used
00040000	Fans warning
00080000	
00100000	Reserved
00200000	Reserved
00400000	Reserved
00800000	Reserved
01000000	Reserved
02000000	Reserved
04000000	Reserved
08000000	Reserved
10000000	Reserved
20000000	Reserved
40000000	PTC 1 Safe Stop [W71]
80000000	Reserved

Table 4.7

4.1.3 Extended Status Words

Extended status word, 16-94 Ext. Status Word

Bit (Hex)	Extended Status Word (16-94 Ext. Status Word)
00000001	Ramping
00000002	AMA tuning
00000004	Start CW/CCW
00000008	Not used
00000010	Not used
00000020	Feedback high
00000040	Feedback low
00000080	Output current high
00000100	Output current low
00000200	Output frequency high
00000400	Output frequency low
00000800	Brake check OK
00001000	Braking max
00002000	Braking
00004000	Out of speed range
00008000	OVC active
00010000	AC brake
00020000	Password Timelock
00040000	Password Protection
00080000	Reference high
00100000	Reference low
00200000	Local Ref./Remote Ref.
00400000	Reserved
00800000	Reserved
01000000	Reserved
02000000	Reserved
04000000	Reserved
08000000	Reserved
10000000	Reserved
20000000	Reserved
40000000	Reserved
80000000	Reserved

Table 4.8

Extended status word 2, 16-95 Ext. Status Word 2

Bit (Hex)	Extended Status Word 2 (16-95 Ext. Status Word 2)
00000001	Off
00000002	Hand / Auto
00000004	Not used
00000008	Not used
00000010	Not used
00000020	Relay 123 active
00000040	Start Prevented
00000080	Control ready
00000100	Drive ready
00000200	Quick Stop
00000400	DC Brake
00000800	Stop
00001000	Standby
00002000	Freeze Output Request
00004000	Freeze Output
00008000	Jog Request
00010000	Jog
00020000	Start Request
00040000	Start
00080000	Start Applied
00100000	Start Delay
00200000	Sleep
00400000	Sleep Boost
00800000	Running
01000000	Bypass
02000000	Fire Mode
04000000	Reserved
08000000	Reserved
10000000	Reserved
20000000	Reserved
40000000	Reserved
80000000	Reserved

Table 4.9

4.1.4 Fault Messages

The warning/alarm information below defines each warning/alarm condition, provides the probable cause for the condition, and details a remedy or troubleshooting procedure.

WARNING 1, 10 Volts low

The control card voltage is below 10V from terminal 50. Remove some of the load from terminal 50, as the 10V supply is overloaded. Max. 15 mA or minimum 590Ω.

This condition can be caused by a short in a connected potentiometer or improper wiring of the potentiometer.

Troubleshooting

Remove the wiring from terminal 50. If the warning clears, the problem is with the customer wiring. If the warning does not clear, replace the control card.

WARNING/ALARM 2, Live zero error

This warning or alarm will only appear if programmed by the user in *6-01 Live Zero Timeout Function*. The signal on one of the analog inputs is less than 50% of the minimum value programmed for that input. This condition can be caused by broken wiring or faulty device sending the signal.

Troubleshooting

Check connections on all the analog input terminals. Control card terminals 53 and 54 for signals, terminal 55 common. MCB 101 terminals 11 and 12 for signals, terminal 10 common. MCB 109 terminals 1, 3, 5 for signals, terminals 2, 4, 6 common).

Check that the Adjustable frequency drive programming and switch settings match the analog signal type.

Perform Input Terminal Signal Test.

WARNING/ALARM 4, Mains phase loss

A phase is missing on the supply side, or the line voltage imbalance is too high. This message also appears for a fault in the input rectifier on the Adjustable frequency drive. Options are programmed at *14-12 Function at Mains Imbalance*.

Troubleshooting

Check the supply voltage and supply currents to the Adjustable frequency drive.

WARNING 5, DC link voltage high

The intermediate circuit voltage (DC) is higher than the high voltage warning limit. The limit is dependent on the Adjustable frequency drive voltage rating. The unit is still active.

WARNING 6, DC link voltage low

The intermediate circuit voltage (DC) is lower than the low voltage warning limit. The limit is dependent on the Adjustable frequency drive voltage rating. The unit is still active.

WARNING/ALARM 7, DC overvoltage

If the intermediate circuit voltage exceeds the limit, the Adjustable frequency drive trips after a time.

Troubleshooting

Connect a brake resistor

Extend the ramp time

Change the ramp type

Activate the functions in *2-10 Brake Function*

Increase *14-26 Trip Delay at Inverter Fault*

WARNING/ALARM 8, DC undervoltage

If the intermediate circuit voltage (DC link) drops below the under voltage limit, the Adjustable frequency drive checks if a 24V DC backup supply is connected. If no 24V DC backup supply is connected, the Adjustable frequency drive trips after a fixed time delay. The time delay varies with unit size.

Troubleshooting:

Check that the supply voltage matches the Adjustable frequency drive voltage.

Perform input voltage test

Perform soft charge circuit test

WARNING/ALARM 9, Inverter overload

The Adjustable frequency drive is about to cut out because of an overload (too high current for too long). The counter for electronic, thermal inverter protection gives a warning at 98% and trips at 100%, while giving an alarm. The Adjustable frequency drive *cannot* be reset until the counter is below 90%.

The fault is that the Adjustable frequency drive is overloaded by more than 100% for too long.

Troubleshooting

Compare the output current shown on the LCP with the Adjustable frequency drive rated current.

Compare the output current shown on the LCP with measured motor current.

Display the Thermal Drive Load on the LCP and monitor the value. When running above the Adjustable frequency drive continuous current rating, the counter should increase. When running below the Adjustable frequency drive continuous current rating, the counter should decrease.

See the derating section in the *Design Guide* for more details if a high switching frequency is required.

WARNING/ALARM 10, Motor overload temperature

According to the electronic thermal protection (ETR), the motor is too hot. Select whether the Adjustable frequency drive gives a warning or an alarm when the counter reaches 100% in *1-90 Motor Thermal Protection*. The fault occurs when the motor is overloaded by more than 100% for too long.

Troubleshooting

- Check for motor overheating.
- Check if the motor is mechanically overloaded.
- Check that the motor current set in *1-24 Motor Current* is correct.
- Ensure that Motor data in parameters 1-20 through 1-25 are set correctly.
- If an external fan is in use, check in *1-91 Motor External Fan* that it is selected.
- Running AMA in *1-29 Automatic Motor Adaptation (AMA)* may tune the Adjustable frequency drive to the motor more accurately and reduce thermal loading.

WARNING/ALARM 11, Motor thermistor over temp

The thermistor might be disconnected. Select whether the Adjustable frequency drive gives a warning or an alarm in *1-90 Motor Thermal Protection*.

Troubleshooting

- Check for motor overheating.
- Check if the motor is mechanically overloaded.
- When using terminal 53 or 54, check that the thermistor is connected correctly between either terminal 53 or 54 (analog voltage input) and terminal 50 (+10V supply) and that the terminal switch for 53 or 54 is set for voltage. Check *1-93 Thermistor Source* selects terminal 53 or 54.
- When using digital inputs 18 or 19, check that the thermistor is connected correctly between either terminal 18 or 19 (digital input PNP only) and terminal 50. Check *1-93 Thermistor Source* selects terminal 18 or 19.

WARNING/ALARM 12, Torque limit

The torque has exceeded the value in *4-16 Torque Limit Motor Mode* or the value in *4-17 Torque Limit Generator Mode*. *14-25 Trip Delay at Torque Limit* can change this from a warning only condition to a warning followed by an alarm.

Troubleshooting

- If the motor torque limit is exceeded during ramp-up, extend the ramp-up time.
- If the generator torque limit is exceeded during ramp-down, extend the ramp-down time.
- If torque limit occurs while running, possibly increase the torque limit. Be sure the system can operate safely at a higher torque.
- Check the application for excessive current draw on the motor.

WARNING/ALARM 13, Overcurrent

The inverter peak current limit (approximately 200% of the rated current) is exceeded. The warning lasts about 1.5 secs., then the Adjustable frequency drive trips and issues an alarm. This fault may be caused by shock loading or fast acceleration with high inertia loads. If extended mechanical brake control is selected, trip can be reset externally.

Troubleshooting

- Remove power and check if the motor shaft can be turned.
- Check that the motor size matches the Adjustable frequency drive.
- Check parameters 1-20 through 1-25. for correct motor data.

ALARM 14, Earth (ground) fault

There is current from the output phases to ground, either in the cable between the Adjustable frequency drive and the motor or in the motor itself.

Troubleshooting:

- Remove power to the Adjustable frequency drive and repair the ground fault.
- Check for ground faults in the motor by measuring the resistance to ground of the motor leads and the motor with a megohmmeter.

ALARM 15, Hardware mismatch

A fitted option is not operational with the present control board hardware or software.

Record the value of the following parameters and contact your Danfoss supplier:

- 15-40 FC Type*
- 15-41 Power Section*
- 15-42 Voltage*
- 15-43 Software Version*
- 15-45 Actual Typecode String*
- 15-49 SW ID Control Card*

15-50 SW ID Power Card

15-60 Option Mounted

15-61 Option SW Version (for each option slot)

ALARM 16, Short circuit

There is short-circuiting in the motor or motor wiring.

Remove power to the Adjustable frequency drive and repair the short circuit.

WARNING/ALARM 17, Control word timeout

There is no communication to the Adjustable frequency drive.

The warning will only be active when *8-04 Control Word Timeout Function* is NOT set to OFF.

If *8-04 Control Word Timeout Function* is set to Stop and Trip, a warning appears and the Adjustable frequency drive ramps down until it stops then displays an alarm.

Troubleshooting:

Check connections on the serial communication cable.

Increase *8-03 Control Word Timeout Time*

Check the operation of the communication equipment.

Verify a proper installation based on EMC requirements.

ALARM 18, Start failed

The speed has not been able to exceed *1-77 Compressor Start Max Speed [RPM]* during start within the allowed time. (set in *1-79 Compressor Start Max Time to Trip*). This may be caused by a blocked motor.

WARNING 23, Internal fan fault

The fan warning function is an extra protective function that checks if the fan is running/mounted. The fan warning can be disabled in *14-53 Fan Monitor* ([0] Disabled).

For the D, E, and F Frame filters, the regulated voltage to the fans is monitored.

Troubleshooting

Check for proper fan operation.

Cycle power to the Adjustable frequency drive and make sure that the fan operates briefly at start-up.

Check the sensors on the heatsink and control card.

WARNING 24, External fan fault

The fan warning function is an extra protective function that checks if the fan is running/mounted. The fan warning can be disabled in *14-53 Fan Monitor* ([0] Disabled).

Troubleshooting

Check for proper fan operation.

Cycle power to the Adjustable frequency drive and make sure that the fan operates briefly at start-up.

Check the sensors on the heatsink and control card.

WARNING 25, Brake resistor short circuit

The brake resistor is monitored during operation. If a short circuit occurs, the brake function is disabled and the warning appears. The Adjustable frequency drive is still operational but without the brake function. Remove power to the Adjustable frequency drive and replace the brake resistor (see *2-15 Brake Check*).

WARNING/ALARM 26, Brake resistor power limit

The power transmitted to the brake resistor is calculated as a mean value over the last 120 seconds of run time. The calculation is based on the intermediate circuit voltage and the brake resistance value set in *2-16 AC Brake Max. Current*. The warning is active when the dissipated braking is higher than 90% of the brake resistance power. If Trip [2] is selected in *2-13 Brake Power Monitoring*, the Adjustable frequency drive will trip when the dissipated braking energy reaches 100%.

WARNING/ALARM 27, Brake chopper fault

The brake transistor is monitored during operation and if a short circuit occurs, the brake function is disabled and a warning is issued. The Adjustable frequency drive is still operational but, since the brake transistor has short-circuited, substantial power is transmitted to the brake resistor, even if it is inactive.

Remove power to the Adjustable frequency drive and remove the brake resistor.

WARNING/ALARM 28, Brake check failed

The brake resistor is not connected or not working. Check *2-15 Brake Check*.

ALARM 29, Heatsink temp

The maximum temperature of the heatsink has been exceeded. The temperature fault will not reset until the temperature falls below a defined heatsink temperature. The trip and reset points are different based on the Adjustable frequency drive power size.

Troubleshooting:

Check for the following conditions.

Ambient temperature too high.

Motor cable too long.

Incorrect airflow clearance above and below the Adjustable frequency drive

Blocked airflow around the Adjustable frequency drive.

Damaged heatsink fan.

Dirty heatsink.

ALARM 30, Motor phase U missing

Motor phase U between the Adjustable frequency drive and the motor is missing.

Remove power from the Adjustable frequency drive and check motor phase U.

ALARM 31, Motor phase V missing

Motor phase V between the Adjustable frequency drive and the motor is missing.

Remove power from the Adjustable frequency drive and check motor phase V.

ALARM 32, Motor phase W missing

Motor phase W between the Adjustable frequency drive and the motor is missing.

Remove power from the Adjustable frequency drive and check motor phase W.

ALARM 33, Soft-charge fault

Too many power-ups have occurred within a short time period. Let the unit cool to operating temperature.

WARNING/ALARM 34, Serial communication bus communication fault

The serial communication bus on the communication option card is not working.

WARNING/ALARM 36, Mains failure

This warning/alarm is only active if the supply voltage to the Adjustable frequency drive is lost and *14-10 Mains Failure* is NOT set to [0] *No Function*. Check the fuses to the Adjustable frequency drive and line power supply to the unit.

ALARM 38, Internal fault

When an internal fault occurs, a code number defined in the table below is displayed.

Troubleshooting

Cycle power

Check that the option is properly installed

Check for loose or missing wiring

It may be necessary to contact your Danfoss supplier or service department. Note the code number for further troubleshooting directions.

No.	Text
0	Serial port cannot be initialized. Contact your Danfoss supplier or Danfoss Service Department.
256-258	Power EEPROM data is defective or too old
512-519	Internal fault. Contact your Danfoss supplier or Danfoss Service Department.
783	Parameter value outside of min/max limits

No.	Text
1024-1284	Internal fault. Contact your Danfoss supplier or the Danfoss Service Department.
1299	Option SW in slot A is too old
1300	Option SW in slot B is too old
1302	Option SW in slot C1 is too old
1315	Option SW in slot A is not supported (not allowed)
1316	Option SW in slot B is not supported (not allowed)
1318	Option SW in slot C1 is not supported (not allowed)
1379-2819	Internal fault. Contact your Danfoss supplier or Danfoss Service Department.
2820	LCP stack overflow
2821	Serial port overflow
2822	USB port overflow
3072-5122	Parameter value is outside its limits
5123	Option in slot A: Hardware incompatible with control board hardware
5124	Option in slot B: Hardware incompatible with control board hardware
5125	Option in slot C0: Hardware incompatible with control board hardware
5126	Option in slot C1: Hardware incompatible with control board hardware
5376-6231	Internal fault. Contact your Danfoss supplier or Danfoss Service Department.

Table 4.10

ALARM 39, Heatsink sensor

No feedback from the heatsink temperature sensor.

The signal from the IGBT thermal sensor is not available on the power card. The problem could be on the power card, on the gate drive card, or the ribbon cable between the power card and gate drive card.

WARNING 40, Overload of digital output terminal 27

Check the load connected to terminal 27 or remove short-circuit connection. Check *5-00 Digital I/O Mode* and *5-01 Terminal 27 Mode*.

WARNING 41, Overload of digital output terminal 29

Check the load connected to terminal 29 or remove short-circuit connection. Check *5-00 Digital I/O Mode* and *5-02 Terminal 29 Mode*.

WARNING 42, Overload of digital output on X30/6 or overload of digital output on X30/7

For X30/6, check the load connected to X30/6 or remove the short-circuit connection. Check *5-32 Term X30/6 Digi Out (MCB 101)*.

For X30/7, check the load connected to X30/7 or remove the short-circuit connection. Check *5-33 Term X30/7 Digi Out (MCB 101)*.

ALARM 45, Earth fault 2

Ground fault on start-up.

Troubleshooting

Check for proper grounding and loose connections.

Check for proper wire size.

Check motor cables for short-circuits or leakage currents.

ALARM 46, Power card supply

The supply on the power card is out of range.

There are three power supplies generated by the switch mode power supply (SMPS) on the power card: 24V, 5V, +/- 18V. When powered with 24V DC with the MCB 107 option, only the 24V and 5V supplies are monitored. When powered with three phase AC line voltage, all three supplies are monitored.

Troubleshooting

Check for a defective power card.

Check for a defective control card.

Check for a defective option card.

If a 24V DC power supply is used, verify proper supply power.

WARNING 47, 24V supply low

The 24 V DC is measured on the control card. The external 24V DC backup power supply may be overloaded, otherwise contact your Danfoss supplier.

WARNING 48, 1.8V supply low

The 1.8V DC supply used on the control card is outside of allowable limits. The power supply is measured on the control card. Check for a defective control card. If an option card is present, check for an overvoltage condition.

WARNING 49, Speed limit

When the speed is not within the specified range in *4-11 Motor Speed Low Limit [RPM]* and *4-13 Motor Speed High Limit [RPM]*, the Adjustable frequency drive will show a warning. When the speed is below the specified limit in *1-86 Trip Speed Low [RPM]* (except when starting or stopping) the Adjustable frequency drive will trip.

ALARM 50, AMA calibration failed

Contact your Danfoss supplier or Danfoss Service Department.

ALARM 51, AMA check Unom and Inom

The settings for motor voltage, motor current, and motor power are wrong. Check the settings in parameters 1-20 to 1-25.

ALARM 52, AMA low Inom

The motor current is too low. Check the setting in *4-18 Current Limit*.

ALARM 53, AMA motor too big

The motor is too big for the AMA to operate.

ALARM 54, AMA motor too small

The motor is too small for the AMA to operate.

ALARM 55, AMA Parameter out of range

The parameter values of the motor are outside of the acceptable range. AMA will not run.

56 ALARM, AMA interrupted by user

The AMA has been interrupted by the user.

ALARM 57, AMA internal fault

Try to restart AMA again. Repeated restarts may overheat the motor.

ALARM 58, AMA internal fault

Contact your Danfoss supplier.

WARNING 59, Current limit

The current is higher than the value in *4-18 Current Limit*. Ensure that Motor data in parameters 1-20 through 1-25 are set correctly. Possibly increase the current limit. Be sure the system can operate safely at a higher limit.

WARNING 60, External interlock

A digital input signal is indicating a fault condition external to the Adjustable frequency drive. An external interlock has commanded the Adjustable frequency drive to trip. Clear the external fault condition. To resume normal operation, apply 24V DC to the terminal programmed for external interlock. Reset the Adjustable frequency drive.

WARNING 62, Output frequency at maximum limit

The output frequency has reached the value set in *4-19 Max Output Frequency*. Check the application to determine the cause. Possibly increase the output frequency limit. Be sure the system can operate safely at a higher output frequency. The warning will clear when the output drops below the maximum limit.

WARNING/ALARM 65, Control card over temperature

The cut-out temperature of the control card is 176°F [80°C].

Troubleshooting

- Check that the ambient operating temperature is within limits.
- Check for clogged filters.
- Check fan operation.
- Check the control card.

WARNING 66, Heatsink temperature low

The Adjustable frequency drive is too cold to operate. This warning is based on the temperature sensor in the IGBT module.

Increase the ambient temperature of the unit. Also, a trickle amount of current can be supplied to the Adjustable frequency drive whenever the motor is stopped

by setting *2-00 DC Hold/Preheat Current* at 5% and *1-80 Function at Stop*

ALARM 67, Option module configuration has changed

One or more options have either been added or removed since the last power-down. Check that the configuration change is intentional and reset the unit.

ALARM 68, Safe stop activated

Loss of the 24V DC signal on terminal 37 has caused the filter to trip. To resume normal operation, apply 24V DC to terminal 37 and reset the filter.

ALARM 69, Power card temperaturePower card temperature

The temperature sensor on the power card is either too hot or too cold.

Troubleshooting

Check that the ambient operating temperature is within limits.

Check for clogged filters.

Check fan operation.

Check the power card.

ALARM 70, Illegal FC configuration

The control card and power card are incompatible. Contact your supplier with the type code of the unit from the nameplate and the part numbers of the cards to check compatibility.

ALARM 71, PTC 1 safe stop

Safe Stop has been activated from the MCB 112 PTC Thermistor Card (motor too warm). Normal operation can be resumed when the MCB 112 applies 24 V DC to T-37 again (when the motor temperature reaches an acceptable level) and when the digital Input from the MCB 112 is deactivated. When that happens, a reset signal must be sent (via Bus, Digital I/O, or by pressing [RESET]).

ALARM 72, Dangerous failure

Safe Stop with Trip Lock. The dangerous failure alarm is issued if the combination of safe stop commands is unexpected. This is the case if the MCB 112 VLT enables X44/10 but safe stop is somehow not enabled. Furthermore, if the MCB 112 is the only device using safe stop (specified through selection [4] or [5] in *5-19 Terminal 37 Safe Stop*), an unexpected combination is activation of safe stop without the X44/10 being activated. The following table summarizes the unexpected combinations that lead to Alarm 72. Note that if X44/10 is activated in selection 2 or 3, this signal is ignored! However, the MCB 112 will still be able to activate Safe Stop.

ALARM 80, Drive initialized to default value

Parameter settings are initialized to default settings after a manual reset. Reset the unit to clear the alarm.

ALARM 92, No-Flow

A no-flow condition has been detected in the system. *22-23 No-Flow Function* is set for alarm. Troubleshoot the system and reset the Adjustable frequency drive after the fault has been cleared.

ALARM 93, Dry pump

A no-flow condition in the system with the Adjustable frequency drive operating at high speed may indicate a dry pump. *22-26 Dry Pump Function* is set for alarm. Troubleshoot the system and reset the Adjustable frequency drive after the fault has been cleared.

ALARM 94, End of curve

Feedback is lower than the setpoint. This may indicate leakage in the system. *22-50 End of Curve Function* is set for alarm. Troubleshoot the system and reset the Adjustable frequency drive after the fault has been cleared.

ALARM 95, Broken belt

Torque is below the torque level set for no load, indicating a broken belt. *22-60 Broken Belt Function* is set for alarm. Troubleshoot the system and reset the Adjustable frequency drive after the fault has been cleared.

ALARM 96, Start delayed

Motor start has been delayed due to short-cycle protection. *22-76 Interval between Starts* is enabled. Troubleshoot the system and reset the Adjustable frequency drive after the fault has been cleared.

WARNING 97, Stop delayed

Stopping the motor has been delayed due to short cycle protection. *22-76 Interval between Starts* is enabled. Troubleshoot the system and reset the Adjustable frequency drive after the fault has been cleared.

WARNING 98, Clock fault

Time is not set or the RTC clock has failed. Reset the clock in *0-70 Date and Time*.

WARNING 200, Fire mode

This indicates the Adjustable frequency drive is operating in fire mode. The warning clears when fire mode is removed. See the fire mode data in the alarm log.

WARNING 201, Fire Mode was Active

This indicates the Adjustable frequency drive had entered fire mode. Cycle power to the unit to remove the warning. See the fire mode data in the alarm log.

WARNING 202, Fire mode limits exceeded

While operating in fire mode one or more alarm conditions have been ignored which would normally trip the unit. Operating in this condition voids unit warranty. Cycle power to the unit to remove the warning. See the fire mode data in the alarm log.

WARNING 203, Missing motor

With a Adjustable frequency drive operating multi-motors, an underload condition was detected. This could indicate a missing motor. Inspect the system for proper operation.

WARNING 204, Locked rotor

With a Adjustable frequency drive operating multi-motors, an overload condition was detected. This could indicate a locked rotor. Inspect the motor for proper operation.

WARNING 250, New spare part

A component in the Adjustable frequency drive has been replaced. Reset the Adjustable frequency drive for normal operation.

WARNING 251, New type code

The power card or other components have been replaced and the type code changed. Reset to remove the warning and resume normal operation.

5 Parameter Lists

5.1 Parameter Options

5.1.1 Default settings

Changes during operation:

“TRUE” means that the parameter can be changed while the Adjustable frequency drive is in operation and “FALSE” means that the Adjustable frequency drive must be stopped before a change can be made.

4 set-up:

'All set-up': the parameter can be set individually in each of the four set-ups, i.e., one single parameter can have four different data values.

'1 set-up': the data value will be the same in all set-ups.

SR:

Size related

N/A:

No default value available.

Conversion index:

This number refers to a conversion figure used when writing or reading by means of an adjustable frequency drive.

Conv. index	100	75	74	70	67	6	5	4	3	2	1	0	-1	-2	-3	-4	-5	-6
Conv. factor	1	3,600,00 0	3,60 0	60	1/60	1,000,0 00	100,00 0	10,00 0	1,000	100	10	1	0.1	0.01	0.001	0.000 1	0.00001	0.00000 1

Table 5.1

Data type	Description	Type
2	Integer 8	Int8
3	Integer 16	Int16
4	Integer 32	Int32
5	Unsigned 8	UInt8
6	Unsigned 16	UInt16
7	Unsigned 32	UInt32
9	Visible String	VisStr
33	Normalized value 2 bytes	N2
35	Bit sequence of 16 boolean variables	V2
54	Time difference w/o date	TimD

Table 5.2

5.1.2 0-** Operation and Display

Par. No. #	Parameter description	Default value (SR = Size related)	4 set-up	Change during operation	Conversion index	Type
0-0* Basic Settings						
0-01	Language	[0] English	1 set-up	TRUE	-	Uint8
0-02	Motor Speed Unit	[1] Hz	2 set-ups	FALSE	-	Uint8
0-03	Regional Settings	ExpressionLimit	2 set-ups	FALSE	-	Uint8
0-04	Operating State at Power-up	[0] Resume	All set-ups	TRUE	-	Uint8
0-05	Local Mode Unit	[0] As Motor Speed Unit	2 set-ups	FALSE	-	Uint8
0-1* Set-up Operations						
0-10	Active Set-up	[1] Set-up 1	1 set-up	TRUE	-	Uint8
0-11	Programming Set-up	[9] Active Set-up	All set-ups	TRUE	-	Uint8
0-12	This Set-up Linked to	[0] Not linked	All set-ups	FALSE	-	Uint8
0-13	Readout: Linked Set-ups	0 N/A	All set-ups	FALSE	0	Uint16
0-14	Readout: Prog. Set-ups / Channel	0 N/A	All set-ups	TRUE	0	Int32
0-2* LCP Display						
0-20	Display Line 1.1 Small	1602	All set-ups	TRUE	-	Uint16
0-21	Display Line 1.2 Small	1614	All set-ups	TRUE	-	Uint16
0-22	Display Line 1.3 Small	1610	All set-ups	TRUE	-	Uint16
0-23	Display Line 2 Large	1613	All set-ups	TRUE	-	Uint16
0-24	Display Line 3 Large	1502	All set-ups	TRUE	-	Uint16
0-25	My Personal Menu	ExpressionLimit	1 set-up	TRUE	0	Uint16
0-3* LCP Cust. Readout						
0-30	Custom Readout Unit	[1] %	All set-ups	TRUE	-	Uint8
0-31	Custom Readout Min Value	ExpressionLimit	All set-ups	TRUE	-2	Int32
0-32	Custom Readout Max Value	100.00 CustomReadoutUnit	All set-ups	TRUE	-2	Int32
0-37	Display Text 1	0 N/A	1 set-up	TRUE	0	VisStr[25]
0-38	Display Text 2	0 N/A	1 set-up	TRUE	0	VisStr[25]
0-39	Display Text 3	0 N/A	1 set-up	TRUE	0	VisStr[25]
0-4* LCP Keypad						
0-40	[Hand on] Key on LCP	[1] Enabled	All set-ups	TRUE	-	Uint8
0-41	[Off] Key on LCP	[1] Enabled	All set-ups	TRUE	-	Uint8
0-42	[Auto on] Key on LCP	[1] Enabled	All set-ups	TRUE	-	Uint8
0-43	[Reset] Key on LCP	[1] Enabled	All set-ups	TRUE	-	Uint8
0-44	[Off/Reset] Key on LCP	[1] Enabled	All set-ups	TRUE	-	Uint8
0-45	[Drive Bypass] Key on LCP	[1] Enabled	All set-ups	TRUE	-	Uint8
0-5* Copy/Save						
0-50	LCP Copy	[0] No copy	All set-ups	FALSE	-	Uint8
0-51	Set-up Copy	[0] No copy	All set-ups	FALSE	-	Uint8
0-6* Password						
0-60	Main Menu Password	100 N/A	1 set-up	TRUE	0	Int16
0-61	Access to Main Menu w/o Password	[0] Full access	1 set-up	TRUE	-	Uint8
0-65	Personal Menu Password	200 N/A	1 set-up	TRUE	0	Int16
0-66	Access to Personal Menu w/o Password	[0] Full access	1 set-up	TRUE	-	Uint8
0-7* Clock Settings						
0-70	Date and Time	ExpressionLimit	All set-ups	TRUE	0	TimeOfDay
0-71	Date Format	ExpressionLimit	1 set-up	TRUE	-	Uint8
0-72	Time Format	ExpressionLimit	1 set-up	TRUE	-	Uint8

Par. No. #	Parameter description	Default value (SR = Size related)	4 set-up	Change during operation	Conversion index	Type
0-74	DST/Summertime	[0] OFF	1 set-up	TRUE	-	UInt8
0-76	DST/Summertime Start	ExpressionLimit	1 set-up	TRUE	0	TimeOfDay
0-77	DST/Summertime End	ExpressionLimit	1 set-up	TRUE	0	TimeOfDay
0-79	Clock Fault	ExpressionLimit	1 set-up	TRUE	-	UInt8
0-81	Working Days	ExpressionLimit	1 set-up	TRUE	-	UInt8
0-82	Additional Working Days	ExpressionLimit	1 set-up	TRUE	0	TimeOfDay
0-83	Additional Non-Working Days	ExpressionLimit	1 set-up	TRUE	0	TimeOfDay
0-89	Date and Time Readout	0 N/A	All set-ups	TRUE	0	VisStr[25]

Table 5.3

5.1.3 1-** Load / Motor

Par. No. #	Parameter description	Default value (SR = Size related)	4 set-up	Change during operation	Conversion index	Type
1-0* General Settings						
1-00	Configuration Mode	ExpressionLimit	All set-ups	TRUE	-	Uint8
1-03	Torque Characteristics	[3] Auto Energy Optim. VT	All set-ups	TRUE	-	Uint8
1-06	Clockwise Direction	[0] Normal	All set-ups	FALSE	-	Uint8
1-1* Motor Selection						
1-10	Motor Construction	[0] Asynchron	All set-ups	FALSE	-	Uint8
1-1* VVC+ PM						
1-14	Damping Gain	120 %	All set-ups	TRUE	0	Int16
1-15	Low Speed Filter Time Const.	ExpressionLimit	All set-ups	TRUE	-2	Uint16
1-16	High Speed Filter Time Const.	ExpressionLimit	All set-ups	TRUE	-2	Uint16
1-17	Voltage filter time const.	ExpressionLimit	All set-ups	TRUE	-3	Uint16
1-2* Motor Data						
1-20	Motor Power [kW]	ExpressionLimit	All set-ups	FALSE	1	Uint32
1-21	Motor Power [HP]	ExpressionLimit	All set-ups	FALSE	-2	Uint32
1-22	Motor Voltage	ExpressionLimit	All set-ups	FALSE	0	Uint16
1-23	Motor Frequency	ExpressionLimit	All set-ups	FALSE	0	Uint16
1-24	Motor Current	ExpressionLimit	All set-ups	FALSE	-2	Uint32
1-25	Motor Nominal Speed	ExpressionLimit	All set-ups	FALSE	67	Uint16
1-26	Motor Cont. Rated Torque	ExpressionLimit	All set-ups	FALSE	-1	Uint32
1-28	Motor Rotation Check	[0] OFF	All set-ups	FALSE	-	Uint8
1-29	Automatic Motor Adaptation (AMA)	[0] Off	All set-ups	FALSE	-	Uint8
1-3* Addl. Motor Data						
1-30	Stator Resistance (Rs)	ExpressionLimit	All set-ups	FALSE	-4	Uint32
1-31	Rotor Resistance (Rr)	ExpressionLimit	All set-ups	FALSE	-4	Uint32
1-35	Main Reactance (Xh)	ExpressionLimit	All set-ups	FALSE	-4	Uint32
1-36	Iron Loss Resistance (Rfe)	ExpressionLimit	All set-ups	FALSE	-3	Uint32
1-37	d-axis Inductance (Ld)	ExpressionLimit	All set-ups	FALSE	-6	Int32
1-39	Motor Poles	ExpressionLimit	All set-ups	FALSE	0	Uint8
1-40	Back EMF at 1000 RPM	ExpressionLimit	All set-ups	FALSE	0	Uint16
1-5* Load-Indep. Setting						
1-50	Motor Magnetization at Zero Speed	100 %	All set-ups	TRUE	0	Uint16
1-51	Min Speed Normal Magnetizing [RPM]	ExpressionLimit	All set-ups	TRUE	67	Uint16
1-52	Min Speed Normal Magnetizing [Hz]	ExpressionLimit	All set-ups	TRUE	-1	Uint16
1-58	Flystart Test Pulses Current	ExpressionLimit	All set-ups	FALSE	0	Uint16
1-59	Flystart Test Pulses Frequency	ExpressionLimit	All set-ups	FALSE	0	Uint16
1-6* Load-Depend. Settg.						
1-60	Low Speed Load Compensation	100 %	All set-ups	TRUE	0	Int16
1-61	High Speed Load Compensation	100 %	All set-ups	TRUE	0	Int16
1-62	Slip Compensation	0 %	All set-ups	TRUE	0	Int16
1-63	Slip Compensation Time Constant	ExpressionLimit	All set-ups	TRUE	-2	Uint16
1-64	Resonance Dampening	100 %	All set-ups	TRUE	0	Uint16
1-65	Resonance Dampening Time Constant	5 ms	All set-ups	TRUE	-3	Uint8
1-66	Min. Current at Low Speed	ExpressionLimit	All set-ups	TRUE	0	Uint8
1-7* Start Adjustments						
1-70	PM Start Mode	[1] Parking	All set-ups	TRUE	-	Uint8
1-71	Start Delay	0.0 s	All set-ups	TRUE	-1	Uint16

Par. No. #	Parameter description	Default value (SR = Size related)	4 set-up	Change during operation	Conversion index	Type
1-72	Start Function	ExpressionLimit	All set-ups	TRUE	-	Uint8
1-73	Flying Start	ExpressionLimit	All set-ups	TRUE	-	Uint8
1-77	Compressor Start Max Speed [RPM]	ExpressionLimit	All set-ups	TRUE	67	Uint16
1-78	Compressor Start Max Speed [Hz]	ExpressionLimit	All set-ups	TRUE	-1	Uint16
1-79	Compressor Start Max Time to Trip	5.0 s	All set-ups	TRUE	-1	Uint8
1-8* Stop Adjustments						
1-80	Function at Stop	[0] Coast	All set-ups	TRUE	-	Uint8
1-81	Min Speed for Function at Stop [RPM]	ExpressionLimit	All set-ups	TRUE	67	Uint16
1-82	Min Speed for Function at Stop [Hz]	ExpressionLimit	All set-ups	TRUE	-1	Uint16
1-86	Trip Speed Low [RPM]	ExpressionLimit	All set-ups	TRUE	67	Uint16
1-87	Trip Speed Low [Hz]	ExpressionLimit	All set-ups	TRUE	-1	Uint16
1-9* Motor Temperature						
1-90	Motor Thermal Protection	ExpressionLimit	All set-ups	TRUE	-	Uint8
1-91	Motor External Fan	[0] No	All set-ups	TRUE	-	Uint16
1-93	Thermistor Source	[0] None	All set-ups	TRUE	-	Uint8

Table 5.4

5.1.4 2-** Brakes

Par. No. #	Parameter description	Default value (SR = Size related)	4 set-up	Change during operation	Conversion index	Type
2-0* DC Brake						
2-00	DC Hold/Preheat Current	50 %	All set-ups	TRUE	0	Uint8
2-01	DC Brake Current	50.0 %	All set-ups	TRUE	0	Uint16
2-02	DC Braking Time	10.0 s	All set-ups	TRUE	-1	Uint16
2-03	DC Brake Cut-in Speed [RPM]	ExpressionLimit	All set-ups	TRUE	67	Uint16
2-04	DC Brake Cut-in Speed [Hz]	ExpressionLimit	All set-ups	TRUE	-1	Uint16
2-06	DC Brake Current	50 %	All set-ups	TRUE	0	Uint16
2-07	DC Braking Time	3.0 s	All set-ups	TRUE	-1	Uint16
2-1* Brake Energy Funct.						
2-10	Brake Function	ExpressionLimit	All set-ups	TRUE	-	Uint8
2-11	Brake Resistor (ohm)	ExpressionLimit	All set-ups	TRUE	-2	Uint32
2-12	Brake Power Limit (kW)	ExpressionLimit	All set-ups	TRUE	0	Uint32
2-13	Brake Power Monitoring	[0] Off	All set-ups	TRUE	-	Uint8
2-15	Brake Check	[0] Off	All set-ups	TRUE	-	Uint8
2-16	AC Brake Max. Current	ExpressionLimit	All set-ups	TRUE	-1	Uint32
2-17	Over-voltage Control	[2] Enabled	All set-ups	TRUE	-	Uint8

Table 5.5

5.1.5 3-** Reference / Ramps

Par. No. #	Parameter description	Default value (SR = Size related)	4 set-up	Change during operation	Conversion index	Type
3-0* Reference Limits						
3-02	Minimum Reference	ExpressionLimit	All set-ups	TRUE	-3	Int32
3-03	Maximum Reference	ExpressionLimit	All set-ups	TRUE	-3	Int32
3-04	Reference Function	ExpressionLimit	All set-ups	TRUE	-	UInt8
3-1* References						
3-10	Preset Reference	0.00 %	All set-ups	TRUE	-2	Int16
3-11	Jog Speed [Hz]	ExpressionLimit	All set-ups	TRUE	-1	UInt16
3-13	Reference Site	[0] Linked to Hand / Auto	All set-ups	TRUE	-	UInt8
3-14	Preset Relative Reference	0.00 %	All set-ups	TRUE	-2	Int32
3-15	Reference 1 Source	[1] Analog input 53	All set-ups	TRUE	-	UInt8
3-16	Reference 2 Source	[20] Digital pot.meter	All set-ups	TRUE	-	UInt8
3-17	Reference 3 Source	[0] No function	All set-ups	TRUE	-	UInt8
3-19	Jog Speed [RPM]	ExpressionLimit	All set-ups	TRUE	67	UInt16
3-4* Ramp 1						
3-41	Ramp 1 Ramp-up Time	ExpressionLimit	All set-ups	TRUE	-2	UInt32
3-42	Ramp 1 Ramp-down Time	ExpressionLimit	All set-ups	TRUE	-2	UInt32
3-5* Ramp 2						
3-51	Ramp 2 Ramp-up Time	ExpressionLimit	All set-ups	TRUE	-2	UInt32
3-52	Ramp 2 Ramp-down Time	ExpressionLimit	All set-ups	TRUE	-2	UInt32
3-8* Other Ramps						
3-80	Jog Ramp Time	ExpressionLimit	All set-ups	TRUE	-2	UInt32
3-81	Quick Stop Ramp Time	ExpressionLimit	2 set-ups	TRUE	-2	UInt32
3-82	Starting Ramp-up Time	ExpressionLimit	2 set-ups	TRUE	-2	UInt32
3-9* Digital Pot. meter						
3-90	Step Size	0.10 %	All set-ups	TRUE	-2	UInt16
3-91	Ramp Time	1.00 s	All set-ups	TRUE	-2	UInt32
3-92	Power Restore	[0] Off	All set-ups	TRUE	-	UInt8
3-93	Maximum Limit	100 %	All set-ups	TRUE	0	Int16
3-94	Minimum Limit	0 %	All set-ups	TRUE	0	Int16
3-95	Ramp Delay	ExpressionLimit	All set-ups	TRUE	-3	TimD

Table 5.6

5.1.6 4-** Limits / Warnings

Par. No. #	Parameter description	Default value (SR = Size related)	4 set-up	Change during operation	Conversion index	Type
4-1* Motor Limits						
4-10	Motor Speed Direction	[2] Both directions	All set-ups	FALSE	-	Uint8
4-11	Motor Speed Low Limit [RPM]	ExpressionLimit	All set-ups	TRUE	67	Uint16
4-12	Motor Speed Low Limit [Hz]	ExpressionLimit	All set-ups	TRUE	-1	Uint16
4-13	Motor Speed High Limit [RPM]	ExpressionLimit	All set-ups	TRUE	67	Uint16
4-14	Motor Speed High Limit [Hz]	ExpressionLimit	All set-ups	TRUE	-1	Uint16
4-16	Torque Limit Motor Mode	ExpressionLimit	All set-ups	TRUE	-1	Uint16
4-17	Torque Limit Generator Mode	100.0 %	All set-ups	TRUE	-1	Uint16
4-18	Current Limit	ExpressionLimit	All set-ups	TRUE	-1	Uint32
4-19	Max Output Frequency	ExpressionLimit	All set-ups	FALSE	-1	Uint16
4-5* Adj. Warnings						
4-50	Warning Current Low	0.00 A	All set-ups	TRUE	-2	Uint32
4-51	Warning Current High	I _{max} VLT (P1637)	All set-ups	TRUE	-2	Uint32
4-52	Warning Speed Low	0 RPM	All set-ups	TRUE	67	Uint16
4-53	Warning Speed High	outputSpeedHighLimit (P413)	All set-ups	TRUE	67	Uint16
4-54	Warning Reference Low	-999999.999 N/A	All set-ups	TRUE	-3	Int32
4-55	Warning Reference High	999999.999 N/A	All set-ups	TRUE	-3	Int32
4-56	Warning Feedback Low	-999999.999 ProcessCtrlUnit	All set-ups	TRUE	-3	Int32
4-57	Warning Feedback High	999999.999 ProcessCtrlUnit	All set-ups	TRUE	-3	Int32
4-58	Missing Motor Phase Function	ExpressionLimit	All set-ups	TRUE	-	Uint8
4-6* Speed Bypass						
4-60	Bypass Speed From [RPM]	ExpressionLimit	All set-ups	TRUE	67	Uint16
4-61	Bypass Speed From [Hz]	ExpressionLimit	All set-ups	TRUE	-1	Uint16
4-62	Bypass Speed to [RPM]	ExpressionLimit	All set-ups	TRUE	67	Uint16
4-63	Bypass Speed To [Hz]	ExpressionLimit	All set-ups	TRUE	-1	Uint16
4-64	Semi-Auto Bypass Set-up	[0] OFF	All set-ups	FALSE	-	Uint8

Table 5.7

5.1.7 5-** Digital In / Out

Par. No. #	Parameter description	Default value (SR = Size related)	4 set-up	Change during operation	Conversion index	Type
5-0* Digital I/O mode						
5-00	Digital I/O Mode	[0] PNP - Active at 24 V	All set-ups	FALSE	-	Uint8
5-01	Terminal 27 Mode	[0] Input	All set-ups	TRUE	-	Uint8
5-02	Terminal 29 Mode	[0] Input	All set-ups	TRUE	-	Uint8
5-1* Digital Inputs						
5-10	Terminal 18 Digital Input	ExpressionLimit	All set-ups	TRUE	-	Uint8
5-11	Terminal 19 Digital Input	ExpressionLimit	All set-ups	TRUE	-	Uint8
5-12	Terminal 27 Digital Input	ExpressionLimit	All set-ups	TRUE	-	Uint8
5-13	Terminal 29 Digital Input	ExpressionLimit	All set-ups	TRUE	-	Uint8
5-14	Terminal 32 Digital Input	ExpressionLimit	All set-ups	TRUE	-	Uint8
5-15	Terminal 33 Digital Input	ExpressionLimit	All set-ups	TRUE	-	Uint8
5-16	Terminal X30/2 Digital Input	ExpressionLimit	All set-ups	TRUE	-	Uint8
5-17	Terminal X30/3 Digital Input	ExpressionLimit	All set-ups	TRUE	-	Uint8

Par. No. #	Parameter description	Default value (SR = Size related)	4 set-up	Change during operation	Conversion index	Type
5-18	Terminal X30/4 Digital Input	ExpressionLimit	All set-ups	TRUE	-	Uint8
5-19	Terminal 37 Safe Stop	[1] Safe Stop Alarm	1 set-up	TRUE	-	Uint8
5-3* Digital Outputs						
5-30	Terminal 27 Digital Output	[0] No operation	All set-ups	TRUE	-	Uint8
5-31	Terminal 29 digital Output	[0] No operation	All set-ups	TRUE	-	Uint8
5-32	Term X30/6 Digi Out (MCB 101)	[0] No operation	All set-ups	TRUE	-	Uint8
5-33	Term X30/7 Digi Out (MCB 101)	[0] No operation	All set-ups	TRUE	-	Uint8
5-4* Relays						
5-40	Function Relay	ExpressionLimit	All set-ups	TRUE	-	Uint8
5-41	On Delay, Relay	0.01 s	All set-ups	TRUE	-2	Uint16
5-42	Off Delay, Relay	0.01 s	All set-ups	TRUE	-2	Uint16
5-5* Pulse Input						
5-50	Term. 29 Low Frequency	100 Hz	All set-ups	TRUE	0	Uint32
5-51	Term. 29 High Frequency	100 Hz	All set-ups	TRUE	0	Uint32
5-52	Term. 29 Low Ref./Feedb. Value	0.000 N/A	All set-ups	TRUE	-3	Int32
5-53	Term. 29 High Ref./Feedb. Value	100.000 N/A	All set-ups	TRUE	-3	Int32
5-54	Pulse Filter Time Constant #29	100 ms	All set-ups	FALSE	-3	Uint16
5-55	Term. 33 Low Frequency	100 Hz	All set-ups	TRUE	0	Uint32
5-56	Term. 33 High Frequency	100 Hz	All set-ups	TRUE	0	Uint32
5-57	Term. 33 Low Ref./Feedb. Value	0.000 N/A	All set-ups	TRUE	-3	Int32
5-58	Term. 33 High Ref./Feedb. Value	100.000 N/A	All set-ups	TRUE	-3	Int32
5-59	Pulse Filter Time Constant #33	100 ms	All set-ups	FALSE	-3	Uint16
5-6* Pulse Output						
5-60	Terminal 27 Pulse Output Variable	[0] No operation	All set-ups	TRUE	-	Uint8
5-62	Pulse Output Max Freq #27	5000 Hz	All set-ups	TRUE	0	Uint32
5-63	Terminal 29 Pulse Output Variable	[0] No operation	All set-ups	TRUE	-	Uint8
5-65	Pulse Output Max Freq #29	5000 Hz	All set-ups	TRUE	0	Uint32
5-66	Terminal X30/6 Pulse Output Variable	[0] No operation	All set-ups	TRUE	-	Uint8
5-68	Pulse Output Max Freq #X30/6	5000 Hz	All set-ups	TRUE	0	Uint32
5-8* I/O Options						
5-80	AHF Cap Reconnect Delay	25 s	2 set-ups	TRUE	0	Uint16
5-9* Bus Controlled						
5-90	Digital & Relay Bus Control	0 N/A	All set-ups	TRUE	0	Uint32
5-93	Pulse Out #27 Bus Control	0.00 %	All set-ups	TRUE	-2	N2
5-94	Pulse Out #27 Timeout Preset	0.00 %	1 set-up	TRUE	-2	Uint16
5-95	Pulse Out #29 Bus Control	0.00 %	All set-ups	TRUE	-2	N2
5-96	Pulse Out #29 Timeout Preset	0.00 %	1 set-up	TRUE	-2	Uint16
5-97	Pulse Out #X30/6 Bus Control	0.00 %	All set-ups	TRUE	-2	N2
5-98	Pulse Out #X30/6 Timeout Preset	0.00 %	1 set-up	TRUE	-2	Uint16

Table 5.8

5.1.8 6-** Analog In / Out

Par. No. #	Parameter description	Default value (SR = Size related)	4 set-up	Change during operation	Conversion index	Type
6-0* Analog I/O Mode						
6-00	Live Zero Timeout Time	10 s	All set-ups	TRUE	0	Uint8
6-01	Live Zero Timeout Function	[0] Off	All set-ups	TRUE	-	Uint8
6-02	Fire Mode Live Zero Timeout Function	[0] Off	All set-ups	TRUE	-	Uint8
6-1* Analog Input 53						
6-10	Terminal 53 Low Voltage	0.07 V	All set-ups	TRUE	-2	Int16
6-11	Terminal 53 High Voltage	10.00 V	All set-ups	TRUE	-2	Int16
6-12	Terminal 53 Low Current	4.00 mA	All set-ups	TRUE	-5	Int16
6-13	Terminal 53 High Current	20.00 mA	All set-ups	TRUE	-5	Int16
6-14	Terminal 53 Low Ref./Feedb. Value	0.000 N/A	All set-ups	TRUE	-3	Int32
6-15	Terminal 53 High Ref./Feedb. Value	ExpressionLimit	All set-ups	TRUE	-3	Int32
6-16	Terminal 53 Filter Time Constant	0.001 s	All set-ups	TRUE	-3	Uint16
6-17	Terminal 53 Live Zero	[1] Enabled	All set-ups	TRUE	-	Uint8
6-2* Analog Input 54						
6-20	Terminal 54 Low Voltage	0.07 V	All set-ups	TRUE	-2	Int16
6-21	Terminal 54 High Voltage	10.00 V	All set-ups	TRUE	-2	Int16
6-22	Terminal 54 Low Current	4.00 mA	All set-ups	TRUE	-5	Int16
6-23	Terminal 54 High Current	20.00 mA	All set-ups	TRUE	-5	Int16
6-24	Terminal 54 Low Ref./Feedb. Value	0.000 N/A	All set-ups	TRUE	-3	Int32
6-25	Terminal 54 High Ref./Feedb. Value	100.000 N/A	All set-ups	TRUE	-3	Int32
6-26	Terminal 54 Filter Time Constant	0.001 s	All set-ups	TRUE	-3	Uint16
6-27	Terminal 54 Live Zero	[1] Enabled	All set-ups	TRUE	-	Uint8
6-3* Analog Input X30/11						
6-30	Terminal X30/11 Low Voltage	0.07 V	All set-ups	TRUE	-2	Int16
6-31	Terminal X30/11 High Voltage	10.00 V	All set-ups	TRUE	-2	Int16
6-34	Term. X30/11 Low Ref./Feedb. Value	0.000 N/A	All set-ups	TRUE	-3	Int32
6-35	Term. X30/11 High Ref./Feedb. Value	100.000 N/A	All set-ups	TRUE	-3	Int32
6-36	Term. X30/11 Filter Time Constant	0.001 s	All set-ups	TRUE	-3	Uint16
6-37	Term. X30/11 Live Zero	[1] Enabled	All set-ups	TRUE	-	Uint8
6-4* Analog Input X30/12						
6-40	Terminal X30/12 Low Voltage	0.07 V	All set-ups	TRUE	-2	Int16
6-41	Terminal X30/12 High Voltage	10.00 V	All set-ups	TRUE	-2	Int16
6-44	Term. X30/12 Low Ref./Feedb. Value	0.000 N/A	All set-ups	TRUE	-3	Int32
6-45	Term. X30/12 High Ref./Feedb. Value	100.000 N/A	All set-ups	TRUE	-3	Int32
6-46	Term. X30/12 Filter Time Constant	0.001 s	All set-ups	TRUE	-3	Uint16
6-47	Term. X30/12 Live Zero	[1] Enabled	All set-ups	TRUE	-	Uint8
6-5* Analog Output 42						
6-50	Terminal 42 Output	ExpressionLimit	All set-ups	TRUE	-	Uint8
6-51	Terminal 42 Output Min Scale	0.00 %	All set-ups	TRUE	-2	Int16
6-52	Terminal 42 Output Max Scale	100.00 %	All set-ups	TRUE	-2	Int16
6-53	Terminal 42 Output Bus Control	0.00 %	All set-ups	TRUE	-2	N2
6-54	Terminal 42 Output Timeout Preset	0.00 %	1 set-up	TRUE	-2	Uint16
6-55	Analog Output Filter	[0] Off	1 set-up	TRUE	-	Uint8
6-6* Analog Output X30/8						
6-60	Terminal X30/8 Output	[0] No operation	All set-ups	TRUE	-	Uint8
6-61	Terminal X30/8 Min. Scale	0.00 %	All set-ups	TRUE	-2	Int16

Par. No. #	Parameter description	Default value (SR = Size related)	4 set-up	Change during operation	Conversion index	Type
6-62	Terminal X30/8 Max. Scale	100.00 %	All set-ups	TRUE	-2	Int16
6-63	Terminal X30/8 Output Bus Control	0.00 %	All set-ups	TRUE	-2	N2
6-64	Terminal X30/8 Output Timeout Preset	0.00 %	1 set-up	TRUE	-2	UInt16

Table 5.9

5

5.1.9 8-** Communication and Options

Par. No. #	Parameter description	Default value (SR = Size related)	4 set-up	Change during operation	Conversion index	Type
8-0* General Settings						
8-01	Control Site	ExpressionLimit	All set-ups	TRUE	-	UInt8
8-02	Control Source	ExpressionLimit	All set-ups	TRUE	-	UInt8
8-03	Control Timeout Time	ExpressionLimit	1 set-up	TRUE	-1	UInt32
8-04	Control Timeout Function	[0] Off	1 set-up	TRUE	-	UInt8
8-05	End-of-Timeout Function	[1] Resume set-up	1 set-up	TRUE	-	UInt8
8-06	Reset Control Timeout	[0] Do not reset	All set-ups	TRUE	-	UInt8
8-07	Diagnosis Trigger	[0] Disable	2 set-ups	TRUE	-	UInt8
8-08	Readout Filtering	ExpressionLimit	All set-ups	TRUE	-	UInt8
8-09	Communication Charset	[1] ANSI X3.4	2 set-ups	TRUE	-	UInt8
8-1* Control Settings						
8-10	Control Profile	[0] FC profile	All set-ups	TRUE	-	UInt8
8-13	Configurable Status Word STW	[1] Profile Default	All set-ups	TRUE	-	UInt8
8-3* FC Port Settings						
8-30	Protocol	ExpressionLimit	1 set-up	TRUE	-	UInt8
8-31	Address	ExpressionLimit	1 set-up	TRUE	0	UInt8
8-32	Baud Rate	ExpressionLimit	1 set-up	TRUE	-	UInt8
8-33	Parity / Stop Bits	ExpressionLimit	1 set-up	TRUE	-	UInt8
8-34	Estimated cycle time	0 ms	2 set-ups	TRUE	-3	UInt32
8-35	Minimum Response Delay	ExpressionLimit	1 set-up	TRUE	-3	UInt16
8-36	Maximum Response Delay	ExpressionLimit	1 set-up	TRUE	-3	UInt16
8-37	Maximum Inter-Char Delay	ExpressionLimit	1 set-up	TRUE	-5	UInt16
8-4* FC MC protocol set						
8-40	Telegram selection	[1] Standard telegram 1	2 set-ups	TRUE	-	UInt8
8-42	PCD write configuration	ExpressionLimit	All set-ups	TRUE	-	UInt16
8-43	PCD read configuration	ExpressionLimit	All set-ups	TRUE	-	UInt16
8-5* Digital/Bus						
8-50	Coasting Select	[3] Logic OR	All set-ups	TRUE	-	UInt8
8-52	DC Brake Select	ExpressionLimit	All set-ups	TRUE	-	UInt8
8-53	Start Select	[3] Logic OR	All set-ups	TRUE	-	UInt8
8-54	Reverse Select	ExpressionLimit	All set-ups	TRUE	-	UInt8
8-55	Set-up Select	[3] Logic OR	All set-ups	TRUE	-	UInt8
8-56	Preset Reference Select	[3] Logic OR	All set-ups	TRUE	-	UInt8
8-7* BACnet						
8-70	BACnet Device Instance	1 N/A	1 set-up	TRUE	0	UInt32
8-72	MS/TP Max Masters	127 N/A	1 set-up	TRUE	0	UInt8
8-73	MS/TP Max Info Frames	1 N/A	1 set-up	TRUE	0	UInt16

Par. No. #	Parameter description	Default value (SR = Size related)	4 set-up	Change during operation	Conversion index	Type
8-74	"I-Am" Service	[0] Send at power-up	1 set-up	TRUE	-	Uint8
8-75	Initialization Password	ExpressionLimit	1 set-up	TRUE	0	VisStr[25]
8-8* FC Port Diagnostics						
8-80	Bus Message Count	0 N/A	All set-ups	TRUE	0	Uint32
8-81	Bus Error Count	0 N/A	All set-ups	TRUE	0	Uint32
8-82	Slave Messages Rcvd	0 N/A	All set-ups	TRUE	0	Uint32
8-83	Slave Error Count	0 N/A	All set-ups	TRUE	0	Uint32
8-84	Slave Messages Sent	0 N/A	All set-ups	TRUE	0	Uint32
8-85	Slave Timeout Errors	0 N/A	All set-ups	TRUE	0	Uint32
8-89	Diagnostics Count	0 N/A	1 set-up	TRUE	0	Int32
8-9* Bus Jog						
8-90	Bus Jog 1 Speed	100 RPM	All set-ups	TRUE	67	Uint16
8-91	Bus Jog 2 Speed	200 RPM	All set-ups	TRUE	67	Uint16
8-94	Bus Feedback 1	0 N/A	1 set-up	TRUE	0	N2
8-95	Bus Feedback 2	0 N/A	1 set-up	TRUE	0	N2
8-96	Bus Feedback 3	0 N/A	1 set-up	TRUE	0	N2

Table 5.10

5.1.10 9-** Profibus

Par. No. #	Parameter description	Default value (SR = Size related)	4 set-up	Change during operation	Conversion index	Type
9-00	Setpoint	0 N/A	All set-ups	TRUE	0	Uint16
9-07	Actual Value	0 N/A	All set-ups	FALSE	0	Uint16
9-15	PCD Write Configuration	ExpressionLimit	2 set-ups	TRUE	-	Uint16
9-16	PCD Read Configuration	ExpressionLimit	2 set-ups	TRUE	-	Uint16
9-18	Node Address	126 N/A	1 set-up	TRUE	0	Uint8
9-22	Telegram Selection	[108] PPO 8	1 set-up	TRUE	-	Uint8
9-23	Parameters for Signals	0	All set-ups	TRUE	-	Uint16
9-27	Parameter Edit	[1] Enabled	2 set-ups	FALSE	-	Uint16
9-28	Process Control	[1] Enable cyclic master	2 set-ups	FALSE	-	Uint8
9-44	Fault Message Counter	0 N/A	All set-ups	TRUE	0	Uint16
9-45	Fault Code	0 N/A	All set-ups	TRUE	0	Uint16
9-47	Fault Number	0 N/A	All set-ups	TRUE	0	Uint16
9-52	Fault Situation Counter	0 N/A	All set-ups	TRUE	0	Uint16
9-53	Profibus Warning Word	0 N/A	All set-ups	TRUE	0	V2
9-63	Actual Baud Rate	[255] No baud rate found	All set-ups	TRUE	-	Uint8
9-64	Device Identification	0 N/A	All set-ups	TRUE	0	Uint16
9-65	Profile Number	0 N/A	All set-ups	TRUE	0	OctStr[2]
9-67	Control Word 1	0 N/A	All set-ups	TRUE	0	V2
9-68	Status Word 1	0 N/A	All set-ups	TRUE	0	V2
9-71	Profibus Save Data Values	[0] Off	All set-ups	TRUE	-	Uint8
9-72	ProfibusDriveReset	[0] No action	1 set-up	FALSE	-	Uint8
9-75	DO Identification	0 N/A	All set-ups	TRUE	0	Uint16
9-80	Defined Parameters (1)	0 N/A	All set-ups	FALSE	0	Uint16
9-81	Defined Parameters (2)	0 N/A	All set-ups	FALSE	0	Uint16
9-82	Defined Parameters (3)	0 N/A	All set-ups	FALSE	0	Uint16
9-83	Defined Parameters (4)	0 N/A	All set-ups	FALSE	0	Uint16
9-84	Defined Parameters (5)	0 N/A	All set-ups	FALSE	0	Uint16
9-90	Changed Parameters (1)	0 N/A	All set-ups	FALSE	0	Uint16
9-91	Changed Parameters (2)	0 N/A	All set-ups	FALSE	0	Uint16
9-92	Changed Parameters (3)	0 N/A	All set-ups	FALSE	0	Uint16
9-93	Changed Parameters (4)	0 N/A	All set-ups	FALSE	0	Uint16
9-94	Changed parameters (5)	0 N/A	All set-ups	FALSE	0	Uint16
9-99	Profibus Revision Counter	0 N/A	All set-ups	TRUE	0	Uint16

Table 5.11

5.1.11 10-** CAN Fieldbus

Par. No. #	Parameter description	Default value (SR = Size related)	4 set-up	Change during operation	Conversion index	Type
10-0* Common Settings						
10-00	CAN Protocol	ExpressionLimit	2 set-ups	FALSE	-	Uint8
10-01	Baud Rate Select	ExpressionLimit	2 set-ups	TRUE	-	Uint8
10-02	MAC ID	ExpressionLimit	2 set-ups	TRUE	0	Uint8
10-05	Readout Transmit Error Counter	0 N/A	All set-ups	TRUE	0	Uint8
10-06	Readout Receive Error Counter	0 N/A	All set-ups	TRUE	0	Uint8
10-07	Readout Bus Off Counter	0 N/A	All set-ups	TRUE	0	Uint8
10-1* DeviceNet						
10-10	Process Data Type Selection	ExpressionLimit	All set-ups	TRUE	-	Uint8
10-11	Process Data Config Write	ExpressionLimit	2 set-ups	TRUE	-	Uint16
10-12	Process Data Config Read	ExpressionLimit	2 set-ups	TRUE	-	Uint16
10-13	Warning Parameter	0 N/A	All set-ups	TRUE	0	Uint16
10-14	Net Reference	[0] Off	2 set-ups	TRUE	-	Uint8
10-15	Net Control	[0] Off	2 set-ups	TRUE	-	Uint8
10-2* COS Filters						
10-20	COS Filter 1	0 N/A	All set-ups	FALSE	0	Uint16
10-21	COS Filter 2	0 N/A	All set-ups	FALSE	0	Uint16
10-22	COS Filter 3	0 N/A	All set-ups	FALSE	0	Uint16
10-23	COS Filter 4	0 N/A	All set-ups	FALSE	0	Uint16
10-3* Parameter Access						
10-30	Array Index	0 N/A	2 set-ups	TRUE	0	Uint8
10-31	Store Data Values	[0] Off	All set-ups	TRUE	-	Uint8
10-32	Devicenet Revision	0 N/A	All set-ups	TRUE	0	Uint16
10-33	Store Always	[0] Off	1 set-up	TRUE	-	Uint8
10-34	DeviceNet Product Code	120 N/A	1 set-up	TRUE	0	Uint16
10-39	Devicenet F Parameters	0 N/A	All set-ups	TRUE	0	Uint32

Table 5.12

5.1.12 11-** LonWorks

Par. No. #	Parameter description	Default value (SR = Size related)	4 set-up	Change during operation	Conversion index	Type
11-0* LonWorks ID						
11-00	Neuron ID	0 N/A	All set-ups	TRUE	0	OctStr[6]
11-1* LON Functions						
11-10	Drive Profile	[0] VSD profile	All set-ups	TRUE	-	Uint8
11-15	LON Warning Word	0 N/A	All set-ups	TRUE	0	Uint16
11-17	XIF Revision	0 N/A	All set-ups	TRUE	0	VisStr[5]
11-18	LonWorks Revision	0 N/A	All set-ups	TRUE	0	VisStr[5]
11-2* LON Param. Access						
11-21	Store Data Values	[0] Off	All set-ups	TRUE	-	Uint8

Table 5.13

5.1.13 13-** Smart Logic Controller

Par. No. #	Parameter description	Default value (SR = Size related)	4 set-up	Change during operation	Conversion index	Type
13-0* SLC Settings						
13-00	SL Controller Mode	ExpressionLimit	2 set-ups	TRUE	-	Uint8
13-01	Start Event	ExpressionLimit	2 set-ups	TRUE	-	Uint8
13-02	Stop Event	ExpressionLimit	2 set-ups	TRUE	-	Uint8
13-03	Reset SLC	[0] Do not reset SLC	All set-ups	TRUE	-	Uint8
13-1* Comparators						
13-10	Comparator Operand	ExpressionLimit	2 set-ups	TRUE	-	Uint8
13-11	Comparator Operator	ExpressionLimit	2 set-ups	TRUE	-	Uint8
13-12	Comparator Value	ExpressionLimit	2 set-ups	TRUE	-3	Int32
13-2* Timers						
13-20	SL Controller Timer	ExpressionLimit	1 set-up	TRUE	-3	TimD
13-4* Logic Rules						
13-40	Logic Rule Boolean 1	ExpressionLimit	2 set-ups	TRUE	-	Uint8
13-41	Logic Rule Operator 1	ExpressionLimit	2 set-ups	TRUE	-	Uint8
13-42	Logic Rule Boolean 2	ExpressionLimit	2 set-ups	TRUE	-	Uint8
13-43	Logic Rule Operator 2	ExpressionLimit	2 set-ups	TRUE	-	Uint8
13-44	Logic Rule Boolean 3	ExpressionLimit	2 set-ups	TRUE	-	Uint8
13-5* States						
13-51	SL Controller Event	ExpressionLimit	2 set-ups	TRUE	-	Uint8
13-52	SL Controller Action	ExpressionLimit	2 set-ups	TRUE	-	Uint8

Table 5.14

5.1.14 14-** Special Functions

Par. No. #	Parameter description	Default value (SR = Size related)	4 set-up	Change during operation	Conversion index	Type
14-0* Inverter Switching						
14-00	Switching Pattern	ExpressionLimit	All set-ups	TRUE	-	Uint8
14-01	Switching Frequency	ExpressionLimit	All set-ups	TRUE	-	Uint8
14-03	Overmodulation	[0] Off	All set-ups	FALSE	-	Uint8
14-04	PWM Random	[0] Off	All set-ups	TRUE	-	Uint8
14-1* Mains On/Off						
14-10	Mains Failure	[0] No function	All set-ups	FALSE	-	Uint8
14-11	Mains Voltage at Mains Fault	ExpressionLimit	All set-ups	TRUE	0	Uint16
14-12	Function at Mains Imbalance	[0] Trip	All set-ups	TRUE	-	Uint8
14-2* Reset Functions						
14-20	Reset Mode	ExpressionLimit	All set-ups	TRUE	-	Uint8
14-21	Automatic Restart Time	10 s	All set-ups	TRUE	0	Uint16
14-22	Operation Mode	[0] Normal operation	All set-ups	TRUE	-	Uint8
14-23	Typecode Setting	ExpressionLimit	2 set-ups	FALSE	-	Uint8
14-25	Trip Delay at Torque Limit	60 s	All set-ups	TRUE	0	Uint8
14-26	Trip Delay at Inverter Fault	ExpressionLimit	All set-ups	TRUE	0	Uint8
14-28	Production Settings	[0] No action	All set-ups	TRUE	-	Uint8
14-29	Service Code	0 N/A	All set-ups	TRUE	0	Int32
14-3* Current Limit Ctrl.						
14-30	Current Lim Cont, Proportional Gain	100 %	All set-ups	FALSE	0	Uint16
14-31	Current Lim Contr, Integration Time	ExpressionLimit	All set-ups	FALSE	-3	Uint16
14-32	Current Lim Ctrl, Filter Time	ExpressionLimit	All set-ups	TRUE	-4	Uint16
14-4* Energy Optimizing						
14-40	VT Level	66 %	All set-ups	FALSE	0	Uint8
14-41	AEO Minimum Magnetization	ExpressionLimit	All set-ups	TRUE	0	Uint8
14-42	Minimum AEO Frequency	10 Hz	All set-ups	TRUE	0	Uint8
14-43	Motor Cos-Phi	ExpressionLimit	All set-ups	TRUE	-2	Uint16
14-5* Environment						
14-50	RFI 1	[1] On	1 set-up	FALSE	-	Uint8
14-51	DC Link Compensation	[1] On	1 set-up	TRUE	-	Uint8
14-52	Fan Control	[0] Auto	All set-ups	TRUE	-	Uint8
14-53	Fan Monitor	[1] Warning	All set-ups	TRUE	-	Uint8
14-55	Output Filter	[0] No Filter	1 set-up	FALSE	-	Uint8
14-59	Actual Number of Inverter Units	ExpressionLimit	1 set-up	FALSE	0	Uint8
14-6* Auto Derate						
14-60	Function at Overtemperature	[0] Trip	All set-ups	TRUE	-	Uint8
14-61	Function at Inverter Overload	[0] Trip	All set-ups	TRUE	-	Uint8
14-62	Inv. Overload Derate Current	95 %	All set-ups	TRUE	0	Uint16

Table 5.15

5.1.15 15-** FC Information

Par. No. #	Parameter description	Default value (SR = Size related)	4 set-up	Change during operation	Conversion index	Type
15-0* Operating Data						
15-00	Operating Hours	0 h	All set-ups	FALSE	74	Uint32
15-01	Running Hours	0 h	All set-ups	FALSE	74	Uint32
15-02	kWh Counter	0 kWh	All set-ups	FALSE	75	Uint32
15-03	Power-ups	0 N/A	All set-ups	FALSE	0	Uint32
15-04	Over Temps	0 N/A	All set-ups	FALSE	0	Uint16
15-05	Over Volts	0 N/A	All set-ups	FALSE	0	Uint16
15-06	Reset kWh Counter	[0] Do not reset	All set-ups	TRUE	-	Uint8
15-07	Reset Running Hours Counter	[0] Do not reset	All set-ups	TRUE	-	Uint8
15-08	Number of Starts	0 N/A	All set-ups	FALSE	0	Uint32
15-1* Data Log Settings						
15-10	Logging Source	0	2 set-ups	TRUE	-	Uint16
15-11	Logging Interval	ExpressionLimit	2 set-ups	TRUE	-3	TimD
15-12	Trigger Event	[0] FALSE	1 set-up	TRUE	-	Uint8
15-13	Logging Mode	[0] Log always	2 set-ups	TRUE	-	Uint8
15-14	Samples Before Trigger	50 N/A	2 set-ups	TRUE	0	Uint8
15-2* Historic Log						
15-20	Historic Log: Event	0 N/A	All set-ups	FALSE	0	Uint8
15-21	Historic Log: Value	0 N/A	All set-ups	FALSE	0	Uint32
15-22	Historic Log: Time	0 ms	All set-ups	FALSE	-3	Uint32
15-23	Historic Log: Date and Time	ExpressionLimit	All set-ups	FALSE	0	TimeOfDay
15-3* Alarm Log						
15-30	Alarm Log: Error Code	0 N/A	All set-ups	FALSE	0	Uint8
15-31	Alarm Log: Value	0 N/A	All set-ups	FALSE	0	Int16
15-32	Alarm Log: Time	0 s	All set-ups	FALSE	0	Uint32
15-33	Alarm Log: Date and Time	ExpressionLimit	All set-ups	FALSE	0	TimeOfDay
15-4* Drive Identification						
15-40	FC Type	0 N/A	All set-ups	FALSE	0	VisStr[6]
15-41	Power Section	0 N/A	All set-ups	FALSE	0	VisStr[20]
15-42	Voltage	0 N/A	All set-ups	FALSE	0	VisStr[20]
15-43	Software Version	0 N/A	All set-ups	FALSE	0	VisStr[5]
15-44	Ordered Typecode String	0 N/A	All set-ups	FALSE	0	VisStr[40]
15-45	Actual Typecode String	0 N/A	All set-ups	FALSE	0	VisStr[40]
15-46	Adj Freq Dr Ordering No.	0 N/A	All set-ups	FALSE	0	VisStr[8]
15-47	Power Card Ordering No.	0 N/A	All set-ups	FALSE	0	VisStr[8]
15-48	LCP ID Num.	0 N/A	All set-ups	FALSE	0	VisStr[20]
15-49	SW ID Control Card	0 N/A	All set-ups	FALSE	0	VisStr[20]
15-50	SW ID Power Card	0 N/A	All set-ups	FALSE	0	VisStr[20]
15-51	Adj Freq Dr Serial No.	0 N/A	All set-ups	FALSE	0	VisStr[10]
15-53	Power Card Serial Number	0 N/A	All set-ups	FALSE	0	VisStr[19]
15-55	Vendor URL	0 N/A	All set-ups	FALSE	0	VisStr[40]
15-56	Vendor Name	0 N/A	All set-ups	FALSE	0	VisStr[40]
15-59	CSIV Filename	ExpressionLimit	1 set-up	FALSE	0	VisStr[16]
15-6* Option Ident						
15-60	Option Mounted	0 N/A	All set-ups	FALSE	0	VisStr[30]
15-61	Option SW Version	0 N/A	All set-ups	FALSE	0	VisStr[20]
15-62	Option Ordering No	0 N/A	All set-ups	FALSE	0	VisStr[8]

Par. No. #	Parameter description	Default value (SR = Size related)	4 set-up	Change during operation	Conversion index	Type
15-63	Option Serial No	0 N/A	All set-ups	FALSE	0	VisStr[18]
15-70	Option in Slot A	0 N/A	All set-ups	FALSE	0	VisStr[30]
15-71	Slot A Option SW Version	0 N/A	All set-ups	FALSE	0	VisStr[20]
15-72	Option in Slot B	0 N/A	All set-ups	FALSE	0	VisStr[30]
15-73	Slot B Option SW Version	0 N/A	All set-ups	FALSE	0	VisStr[20]
15-74	Option in Slot C0	0 N/A	All set-ups	FALSE	0	VisStr[30]
15-75	Slot C0 Option SW Version	0 N/A	All set-ups	FALSE	0	VisStr[20]
15-76	Option in Slot C1	0 N/A	All set-ups	FALSE	0	VisStr[30]
15-77	Slot C1 Option SW Version	0 N/A	All set-ups	FALSE	0	VisStr[20]
15-9* Parameter Info						
15-92	Defined Parameters	0 N/A	All set-ups	FALSE	0	Uint16
15-93	Modified Parameters	0 N/A	All set-ups	FALSE	0	Uint16
15-98	Drive Identification	0 N/A	All set-ups	FALSE	0	VisStr[40]
15-99	Parameter Metadata	0 N/A	All set-ups	FALSE	0	Uint16

Table 5.16

5.1.16 16-** Data Readouts

Par. No. #	Parameter description	Default value (SR = Size related)	4 set-up	Change during operation	Conversion index	Type
16-0* General Status						
16-00	Control Word	0 N/A	All set-ups	FALSE	0	V2
16-01	Reference [Unit]	0.000 ReferenceFeedbackUnit	All set-ups	FALSE	-3	Int32
16-02	Reference %	0.0 %	All set-ups	FALSE	-1	Int16
16-03	Status Word	0 N/A	All set-ups	FALSE	0	V2
16-05	Main Actual Value [%]	0.00 %	All set-ups	FALSE	-2	N2
16-09	Custom Readout	0.00 CustomReadoutUnit	All set-ups	FALSE	-2	Int32
16-1* Motor Status						
16-10	Power [kW]	0.00 kW	All set-ups	FALSE	1	Int32
16-11	Power [hp]	0.00 hp	All set-ups	FALSE	-2	Int32
16-12	Motor voltage	0.0 V	All set-ups	FALSE	-1	Uint16
16-13	Frequency	0.0 Hz	All set-ups	FALSE	-1	Uint16
16-14	Motor Current	0.00 A	All set-ups	FALSE	-2	Int32
16-15	Frequency [%]	0.00 %	All set-ups	FALSE	-2	N2
16-16	Torque [Nm]	0.0 Nm	All set-ups	FALSE	-1	Int32
16-17	Speed [RPM]	0 RPM	All set-ups	FALSE	67	Int32
16-18	Motor Thermal	0 %	All set-ups	FALSE	0	Uint8
16-22	Torque [%]	0 %	All set-ups	FALSE	0	Int16
16-26	Power Filtered [kW]	0.000 kW	All set-ups	FALSE	0	Int32
16-27	Power Filtered [hp]	0.000 hp	All set-ups	FALSE	-3	Int32
16-3* Drive Status						
16-30	DC Link Voltage	0 V	All set-ups	FALSE	0	Uint16
16-32	Brake Energy /s	0.000 kW	All set-ups	FALSE	0	Uint32
16-33	Brake Energy /2 min	0.000 kW	All set-ups	FALSE	0	Uint32
16-34	Heatsink Temp.	0 °C	All set-ups	FALSE	100	Uint8
16-35	Inverter Thermal	0 %	All set-ups	FALSE	0	Uint8
16-36	Inv. Nom. Current	ExpressionLimit	All set-ups	FALSE	-2	Uint32
16-37	Inv. Max. Current	ExpressionLimit	All set-ups	FALSE	-2	Uint32
16-38	SL Controller State	0 N/A	All set-ups	FALSE	0	Uint8

Par. No. #	Parameter description	Default value (SR = Size related)	4 set-up	Change during operation	Conversion index	Type
16-39	Control Card Temp.	0 °C	All set-ups	FALSE	100	Uint8
16-40	Logging Buffer Full	[0] No	All set-ups	TRUE	-	Uint8
16-41	Logging Buffer Full	0 N/A	All set-ups	TRUE	0	VisStr[50]
16-43	Timed Actions Status	[0] Timed Actions Auto	All set-ups	TRUE	-	Uint8
16-49	Current Fault Source	0 N/A	All set-ups	TRUE	0	Uint8
16-5* Ref. & Feedb.						
16-50	External Reference	0.0 N/A	All set-ups	FALSE	-1	Int16
16-52	Feedback [Unit]	0.000 ProcessCtrlUnit	All set-ups	FALSE	-3	Int32
16-53	Digi Pot Reference	0.00 N/A	All set-ups	FALSE	-2	Int16
16-54	Feedback 1 [Unit]	0.000 ProcessCtrlUnit	All set-ups	FALSE	-3	Int32
16-55	Feedback 2 [Unit]	0.000 ProcessCtrlUnit	All set-ups	FALSE	-3	Int32
16-56	Feedback 3 [Unit]	0.000 ProcessCtrlUnit	All set-ups	FALSE	-3	Int32
16-58	PID Output [%]	0.0 %	All set-ups	TRUE	-1	Int16
16-6* Inputs & Outputs						
16-60	Digital Input	0 N/A	All set-ups	FALSE	0	Uint16
16-61	Terminal 53 Switch Setting	[0] Current	All set-ups	FALSE	-	Uint8
16-62	Analog Input 53	0.000 N/A	All set-ups	FALSE	-3	Int32
16-63	Terminal 54 Switch Setting	[0] Current	All set-ups	FALSE	-	Uint8
16-64	Analog Input 54	0.000 N/A	All set-ups	FALSE	-3	Int32
16-65	Analog Output 42 [mA]	0.000 N/A	All set-ups	FALSE	-3	Int16
16-66	Digital Output [bin]	0 N/A	All set-ups	FALSE	0	Int16
16-67	Pulse Input #29 [Hz]	0 N/A	All set-ups	FALSE	0	Int32
16-68	Pulse Input #33 [Hz]	0 N/A	All set-ups	FALSE	0	Int32
16-69	Pulse Output #27 [Hz]	0 N/A	All set-ups	FALSE	0	Int32
16-70	Pulse Output #29 [Hz]	0 N/A	All set-ups	FALSE	0	Int32
16-71	Relay Output [bin]	0 N/A	All set-ups	FALSE	0	Int16
16-72	Counter A	0 N/A	All set-ups	TRUE	0	Int32
16-73	Counter B	0 N/A	All set-ups	TRUE	0	Int32
16-75	Analog In X30/11	0.000 N/A	All set-ups	FALSE	-3	Int32
16-76	Analog In X30/12	0.000 N/A	All set-ups	FALSE	-3	Int32
16-77	Analog Out X30/8 [mA]	0.000 N/A	All set-ups	FALSE	-3	Int16
16-8* Fieldbus & FC Port						
16-80	Fieldbus CTW 1	0 N/A	All set-ups	FALSE	0	V2
16-82	Fieldbus REF 1	0 N/A	All set-ups	FALSE	0	N2
16-84	Comm. Option Status	0 N/A	All set-ups	FALSE	0	V2
16-85	FC Port CTW 1	0 N/A	All set-ups	FALSE	0	V2
16-86	FC Port REF 1	0 N/A	All set-ups	FALSE	0	N2
16-9* Diagnosis Readouts						
16-90	Alarm Word	0 N/A	All set-ups	FALSE	0	Uint32
16-91	Alarm word 2	0 N/A	All set-ups	FALSE	0	Uint32
16-92	Warning Word	0 N/A	All set-ups	FALSE	0	Uint32
16-93	Warning word 2	0 N/A	All set-ups	FALSE	0	Uint32
16-94	Ext. Status Word	0 N/A	All set-ups	FALSE	0	Uint32
16-95	Ext. Status Word 2	0 N/A	All set-ups	FALSE	0	Uint32
16-96	Maintenance Word	0 N/A	All set-ups	FALSE	0	Uint32

Table 5.17

5.1.17 18-** Info & Readouts

Par. No. #	Parameter description	Default value (SR = Size related)	4 set-up	Change during operation	Conversion index	Type
18-0* Maintenance Log						
18-00	Maintenance Log: Item	0 N/A	All set-ups	FALSE	0	Uint8
18-01	Maintenance Log: Action	0 N/A	All set-ups	FALSE	0	Uint8
18-02	Maintenance Log: Time	0 s	All set-ups	FALSE	0	Uint32
18-03	Maintenance Log: Date and Time	ExpressionLimit	All set-ups	FALSE	0	TimeOf Day
18-1* Fire Mode Log						
18-10	Fire Mode Log: Event	0 N/A	All set-ups	FALSE	0	Uint8
18-11	Fire Mode Log: Time	0 s	All set-ups	FALSE	0	Uint32
18-12	Fire Mode Log: Date and Time	ExpressionLimit	All set-ups	FALSE	0	TimeOf Day
18-3* Inputs & Outputs						
18-30	Analog Input X42/1	0.000 N/A	All set-ups	FALSE	-3	Int32
18-31	Analog Input X42/3	0.000 N/A	All set-ups	FALSE	-3	Int32
18-32	Analog Input X42/5	0.000 N/A	All set-ups	FALSE	-3	Int32
18-33	Analog Out X42/7 [V]	0.000 N/A	All set-ups	FALSE	-3	Int16
18-34	Analog Out X42/9 [V]	0.000 N/A	All set-ups	FALSE	-3	Int16
18-35	Analog Out X42/11 [V]	0.000 N/A	All set-ups	FALSE	-3	Int16
18-36	Analog Input X48/2 [mA]	0.000 N/A	All set-ups	TRUE	-3	Int32
18-37	Temp. Input X48/4	0 N/A	All set-ups	TRUE	0	Int16
18-38	Temp. Input X48/7	0 N/A	All set-ups	TRUE	0	Int16
18-39	Temp. Input X48/10	0 N/A	All set-ups	TRUE	0	Int16
18-5* Ref. & Feedb.						
18-50	Sensorless Readout [unit]	0.000 SensorlessUnit	All set-ups	FALSE	-3	Int32

Table 5.18

5.1.18 20-** FC Closed-loop

Par. No. #	Parameter description	Default value (SR = Size related)	4 set-up	Change during operation	Conversion index	Type
20-0* Feedback						
20-00	Feedback 1 Source	[2] Analog input 54	All set-ups	TRUE	-	UInt8
20-01	Feedback 1 Conversion	[0] Linear	All set-ups	FALSE	-	UInt8
20-02	Feedback 1 Source Unit	ExpressionLimit	All set-ups	TRUE	-	UInt8
20-03	Feedback 2 Source	[0] No function	All set-ups	TRUE	-	UInt8
20-04	Feedback 2 Conversion	[0] Linear	All set-ups	FALSE	-	UInt8
20-05	Feedback 2 Source Unit	ExpressionLimit	All set-ups	TRUE	-	UInt8
20-06	Feedback 3 Source	[0] No function	All set-ups	TRUE	-	UInt8
20-07	Feedback 3 Conversion	[0] Linear	All set-ups	FALSE	-	UInt8
20-08	Feedback 3 Source Unit	ExpressionLimit	All set-ups	TRUE	-	UInt8
20-12	Reference/Feedback Unit	ExpressionLimit	All set-ups	TRUE	-	UInt8
20-13	Minimum Reference/Feedb.	0.000 ProcessCtrlUnit	All set-ups	TRUE	-3	Int32
20-14	Maximum Reference/Feedb.	100.000 ProcessCtrlUnit	All set-ups	TRUE	-3	Int32
20-2* Feedback/Setpoint						
20-20	Feedback Function	[3] Minimum	All set-ups	TRUE	-	UInt8
20-21	Setpoint 1	0.000 ProcessCtrlUnit	All set-ups	TRUE	-3	Int32
20-22	Setpoint 2	0.000 ProcessCtrlUnit	All set-ups	TRUE	-3	Int32
20-23	Setpoint 3	0.000 ProcessCtrlUnit	All set-ups	TRUE	-3	Int32
20-3* Feedb. Adv. Conv.						
20-30	Refrigerant	[0] R22	All set-ups	TRUE	-	UInt8
20-31	User-defined Refrigerant A1	10.0000 N/A	All set-ups	TRUE	-4	UInt32
20-32	User-defined Refrigerant A2	-2250.00 N/A	All set-ups	TRUE	-2	Int32
20-33	User-defined Refrigerant A3	250.000 N/A	All set-ups	TRUE	-3	UInt32
20-34	Duct 1 Area [m2]	0.500 m2	All set-ups	TRUE	-3	UInt32
20-35	Duct 1 Area [in2]	750 in2	All set-ups	TRUE	0	UInt32
20-36	Duct 2 Area [m2]	0.500 m2	All set-ups	TRUE	-3	UInt32
20-37	Duct 2 Area [in2]	750 in2	All set-ups	TRUE	0	UInt32
20-38	Air Density Factor [%]	100 %	All set-ups	TRUE	0	UInt32
20-6* Sensorless						
20-60	Sensorless Unit	ExpressionLimit	All set-ups	TRUE	-	UInt8
20-69	Sensorless Information	0 N/A	All set-ups	TRUE	0	VisStr[25]
20-7* PID Autotuning						
20-70	Closed-loop Type	[0] Auto	2 set-ups	TRUE	-	UInt8
20-71	PID Performance	[0] Normal	2 set-ups	TRUE	-	UInt8
20-72	PID Output Change	0.10 N/A	2 set-ups	TRUE	-2	UInt16
20-73	Minimum Feedback Level	-999999.000 ProcessCtrlUnit	2 set-ups	TRUE	-3	Int32
20-74	Maximum Feedback Level	999999.000 ProcessCtrlUnit	2 set-ups	TRUE	-3	Int32
20-79	PID Autotuning	[0] Disabled	All set-ups	TRUE	-	UInt8
20-8* PID Basic Settings						
20-81	PID Normal/ Inverse Control	[0] Normal	All set-ups	TRUE	-	UInt8
20-82	PID Start Speed [RPM]	ExpressionLimit	All set-ups	TRUE	67	UInt16
20-83	PID Start Speed [Hz]	ExpressionLimit	All set-ups	TRUE	-1	UInt16
20-84	On Reference Bandwidth	5 %	All set-ups	TRUE	0	UInt8
20-9* PID Controller						
20-91	PID Anti Windup	[1] On	All set-ups	TRUE	-	UInt8
20-93	PID Proportional Gain	0.50 N/A	All set-ups	TRUE	-2	UInt16

Par. No. #	Parameter description	Default value (SR = Size related)	4 set-up	Change during operation	Conversion index	Type
20-94	PID Integral Time	20.00 s	All set-ups	TRUE	-2	Uint32
20-95	PID Differentiation Time	0.00 s	All set-ups	TRUE	-2	Uint16
20-96	PID Diff. Gain Limit	5.0 N/A	All set-ups	TRUE	-1	Uint16

Table 5.19

5.1.19 21-** Ext. Closed-loop

5

Par. No. #	Parameter description	Default value (SR = Size related)	4 set-up	Change during operation	Conversion index	Type
21-0* Ext. CL Autotuning						
21-00	Closed-loop Type	[0] Auto	2 set-ups	TRUE	-	Uint8
21-01	PID Performance	[0] Normal	2 set-ups	TRUE	-	Uint8
21-02	PID Output Change	0.10 N/A	2 set-ups	TRUE	-2	Uint16
21-03	Minimum Feedback Level	-999999.000 N/A	2 set-ups	TRUE	-3	Int32
21-04	Maximum Feedback Level	999999.000 N/A	2 set-ups	TRUE	-3	Int32
21-09	PID Autotuning	[0] Disabled	All set-ups	TRUE	-	Uint8
21-1* Ext. CL 1 Ref./Fb.						
21-10	Ext. 1 Ref./Feedback Unit	[1] %	All set-ups	TRUE	-	Uint8
21-11	Ext. 1 Minimum Reference	0.000 ExtPID1Unit	All set-ups	TRUE	-3	Int32
21-12	Ext. 1 Maximum Reference	100.000 ExtPID1Unit	All set-ups	TRUE	-3	Int32
21-13	Ext. 1 Reference Source	[0] No function	All set-ups	TRUE	-	Uint8
21-14	Ext. 1 Feedback Source	[0] No function	All set-ups	TRUE	-	Uint8
21-15	Ext. 1 Setpoint	0.000 ExtPID1Unit	All set-ups	TRUE	-3	Int32
21-17	Ext. 1 Reference [Unit]	0.000 ExtPID1Unit	All set-ups	TRUE	-3	Int32
21-18	Ext. 1 Feedback [Unit]	0.000 ExtPID1Unit	All set-ups	TRUE	-3	Int32
21-19	Ext. 1 Output [%]	0 %	All set-ups	TRUE	0	Int32
21-2* Ext. CL 1 PID						
21-20	Ext. 1 Normal/Inverse Control	[0] Normal	All set-ups	TRUE	-	Uint8
21-21	Ext. 1 Proportional Gain	0.01 N/A	All set-ups	TRUE	-2	Uint16
21-22	Ext. 1 Integral Time	10000.00 s	All set-ups	TRUE	-2	Uint32
21-23	Ext. 1 Differentiation Time	0.00 s	All set-ups	TRUE	-2	Uint16
21-24	Ext. 1 Dif. Gain Limit	5.0 N/A	All set-ups	TRUE	-1	Uint16
21-3* Ext. CL 2 Ref./Fb.						
21-30	Ext. 2 Ref./Feedback Unit	[1] %	All set-ups	TRUE	-	Uint8
21-31	Ext. 2 Minimum Reference	0.000 ExtPID2Unit	All set-ups	TRUE	-3	Int32
21-32	Ext. 2 Maximum Reference	100.000 ExtPID2Unit	All set-ups	TRUE	-3	Int32
21-33	Ext. 2 Reference Source	[0] No function	All set-ups	TRUE	-	Uint8
21-34	Ext. 2 Feedback Source	[0] No function	All set-ups	TRUE	-	Uint8
21-35	Ext. 2 Setpoint	0.000 ExtPID2Unit	All set-ups	TRUE	-3	Int32
21-37	Ext. 2 Reference [Unit]	0.000 ExtPID2Unit	All set-ups	TRUE	-3	Int32
21-38	Ext. 2 Feedback [Unit]	0.000 ExtPID2Unit	All set-ups	TRUE	-3	Int32
21-39	Ext. 2 Output [%]	0 %	All set-ups	TRUE	0	Int32
21-4* Ext. CL 2 PID						
21-40	Ext. 2 Normal/Inverse Control	[0] Normal	All set-ups	TRUE	-	Uint8
21-41	Ext. 2 Proportional Gain	0.01 N/A	All set-ups	TRUE	-2	Uint16
21-42	Ext. 2 Integral Time	10000.00 s	All set-ups	TRUE	-2	Uint32
21-43	Ext. 2 Differentiation Time	0.00 s	All set-ups	TRUE	-2	Uint16
21-44	Ext. 2 Dif. Gain Limit	5.0 N/A	All set-ups	TRUE	-1	Uint16
21-5* Ext. CL 3 Ref./Fb.						
21-50	Ext. 3 Ref./Feedback Unit	[1] %	All set-ups	TRUE	-	Uint8
21-51	Ext. 3 Minimum Reference	0.000 ExtPID3Unit	All set-ups	TRUE	-3	Int32
21-52	Ext. 3 Maximum Reference	100.000 ExtPID3Unit	All set-ups	TRUE	-3	Int32
21-53	Ext. 3 Reference Source	[0] No function	All set-ups	TRUE	-	Uint8
21-54	Ext. 3 Feedback Source	[0] No function	All set-ups	TRUE	-	Uint8
21-55	Ext. 3 Setpoint	0.000 ExtPID3Unit	All set-ups	TRUE	-3	Int32

Par. No. #	Parameter description	Default value (SR = Size related)	4 set-up	Change during operation	Conversion index	Type
21-57	Ext. 3 Reference [Unit]	0.000 ExtPID3Unit	All set-ups	TRUE	-3	Int32
21-58	Ext. 3 Feedback [Unit]	0.000 ExtPID3Unit	All set-ups	TRUE	-3	Int32
21-59	Ext. 3 Output [%]	0 %	All set-ups	TRUE	0	Int32
21-6* Ext. CL 3 PID						
21-60	Ext. 3 Normal/Inverse Control	[0] Normal	All set-ups	TRUE	-	UInt8
21-61	Ext. 3 Proportional Gain	0.01 N/A	All set-ups	TRUE	-2	UInt16
21-62	Ext. 3 Integral Time	10000.00 s	All set-ups	TRUE	-2	UInt32
21-63	Ext. 3 Differentiation Time	0.00 s	All set-ups	TRUE	-2	UInt16
21-64	Ext. 3 Dif. Gain Limit	5.0 N/A	All set-ups	TRUE	-1	UInt16

Table 5.20

5.1.20 22-** Application Functions

Par. No. #	Parameter description	Default value (SR = Size related)	4 set-up	Change during operation	Conversion index	Type
22-0* Miscellaneous						
22-00	External Interlock Delay	0 s	All set-ups	TRUE	0	UInt16
22-01	Power Filter Time	0.50 s	2 set-ups	TRUE	-2	UInt16
22-2* No-Flow Detection						
22-20	Low Power Auto Set-up	[0] OFF	All set-ups	FALSE	-	UInt8
22-21	Low Power Detection	[0] Disabled	All set-ups	TRUE	-	UInt8
22-22	Low Speed Detection	[0] Disabled	All set-ups	TRUE	-	UInt8
22-23	No-Flow Function	[0] OFF	All set-ups	TRUE	-	UInt8
22-24	No-Flow Delay	10 s	All set-ups	TRUE	0	UInt16
22-26	Dry Pump Function	[0] OFF	All set-ups	TRUE	-	UInt8
22-27	Dry Pump Delay	10 s	All set-ups	TRUE	0	UInt16
22-3* No-Flow Power Tuning						
22-30	No-Flow Power	0.00 kW	All set-ups	TRUE	1	UInt32
22-31	Power Correction Factor	100 %	All set-ups	TRUE	0	UInt16
22-32	Low Speed [RPM]	ExpressionLimit	All set-ups	TRUE	67	UInt16
22-33	Low Speed [Hz]	ExpressionLimit	All set-ups	TRUE	-1	UInt16
22-34	Low Speed Power [kW]	ExpressionLimit	All set-ups	TRUE	1	UInt32
22-35	Low Speed Power [HP]	ExpressionLimit	All set-ups	TRUE	-2	UInt32
22-36	High Speed [RPM]	ExpressionLimit	All set-ups	TRUE	67	UInt16
22-37	High Speed [Hz]	ExpressionLimit	All set-ups	TRUE	-1	UInt16
22-38	High Speed Power [kW]	ExpressionLimit	All set-ups	TRUE	1	UInt32
22-39	High Speed Power [HP]	ExpressionLimit	All set-ups	TRUE	-2	UInt32
22-4* Sleep Mode						
22-40	Minimum Run Time	10 s	All set-ups	TRUE	0	UInt16
22-41	Minimum Sleep Time	10 s	All set-ups	TRUE	0	UInt16
22-42	Wake-up Speed [RPM]	ExpressionLimit	All set-ups	TRUE	67	UInt16
22-43	Wake-up Speed [Hz]	ExpressionLimit	All set-ups	TRUE	-1	UInt16
22-44	Wake-up Ref./FB Difference	10 %	All set-ups	TRUE	0	Int8
22-45	Setpoint Boost	0 %	All set-ups	TRUE	0	Int8
22-46	Maximum Boost Time	60 s	All set-ups	TRUE	0	UInt16
22-5* End of Curve						

Par. No. #	Parameter description	Default value (SR = Size related)	4 set-up	Change during operation	Conversion index	Type
22-50	End of Curve Function	[0] OFF	All set-ups	TRUE	-	Uint8
22-51	End of Curve Delay	10 s	All set-ups	TRUE	0	Uint16
22-6* Broken Belt Detection						
22-60	Broken Belt Function	[0] OFF	All set-ups	TRUE	-	Uint8
22-61	Broken Belt Torque	10 %	All set-ups	TRUE	0	Uint8
22-62	Broken Belt Delay	10 s	All set-ups	TRUE	0	Uint16
22-7* Short Cycle Protection						
22-75	Short Cycle Protection	[0] Disabled	All set-ups	TRUE	-	Uint8
22-76	Interval between Starts	start_to_start_min_on_time (P2277)	All set-ups	TRUE	0	Uint16
22-77	Minimum Run Time	0 s	All set-ups	TRUE	0	Uint16
22-78	Minimum Run Time Override	[0] Disabled	All set-ups	FALSE	-	Uint8
22-79	Minimum Run Time Override Value	0.000 ProcessCtrlUnit	All set-ups	TRUE	-3	Int32
22-8* Flow Compensation						
22-80	Flow Compensation	[0] Disabled	All set-ups	TRUE	-	Uint8
22-81	Square-linear Curve Approximation	100 %	All set-ups	TRUE	0	Uint8
22-82	Work Point Calculation	[0] Disabled	All set-ups	TRUE	-	Uint8
22-83	Speed at No-Flow [RPM]	ExpressionLimit	All set-ups	TRUE	67	Uint16
22-84	Speed at No-Flow [Hz]	ExpressionLimit	All set-ups	TRUE	-1	Uint16
22-85	Speed at Design Point [RPM]	ExpressionLimit	All set-ups	TRUE	67	Uint16
22-86	Speed at Design Point [Hz]	ExpressionLimit	All set-ups	TRUE	-1	Uint16
22-87	Pressure at No-Flow Speed	0.000 N/A	All set-ups	TRUE	-3	Int32
22-88	Pressure at Rated Speed	999999.999 N/A	All set-ups	TRUE	-3	Int32
22-89	Flow at Design Point	0.000 N/A	All set-ups	TRUE	-3	Int32
22-90	Flow at Rated Speed	0.000 N/A	All set-ups	TRUE	-3	Int32

Table 5.21

5.1.21 23-** Time-based Functions

Par. No. #	Parameter description	Default value (SR = Size related)	4 set-up	Change during operation	Conversion index	Type
23-0* Timed Actions						
23-00	ON Time	ExpressionLimit	2 set-ups	TRUE	0	TimeOfDay-WoDate
23-01	ON Action	[0] DISABLED	2 set-ups	TRUE	-	Uint8
23-02	OFF Time	ExpressionLimit	2 set-ups	TRUE	0	TimeOfDay-WoDate
23-03	OFF Action	[1] No action	2 set-ups	TRUE	-	Uint8
23-04	Occurrence	[0] All days	2 set-ups	TRUE	-	Uint8
23-0* Timed Actions Set.						
23-08	Timed Actions Mode	[0] Timed Actions Auto	2 set-ups	TRUE	-	Uint8
23-09	Timed Actions Reactivation	[1] Enabled	2 set-ups	TRUE	-	Uint8
23-1* Maintenance						
23-10	Maintenance Item	[1] Motor bearings	1 set-up	TRUE	-	Uint8
23-11	Maintenance Action	[1] Lubricate	1 set-up	TRUE	-	Uint8
23-12	Maintenance Time Base	[0] Disabled	1 set-up	TRUE	-	Uint8
23-13	Maintenance Time Interval	1 h	1 set-up	TRUE	74	Uint32
23-14	Maintenance Date and Time	ExpressionLimit	1 set-up	TRUE	0	TimeOfDay
23-1* Maintenance Reset						
23-15	Reset Maintenance Word	[0] Do not reset	All set-ups	TRUE	-	Uint8
23-16	Maintenance Text	0 N/A	1 set-up	TRUE	0	VisStr[20]
23-5* Energy Log						
23-50	Energy Log Resolution	[5] Last 24 Hours	2 set-ups	TRUE	-	Uint8
23-51	Period Start	ExpressionLimit	2 set-ups	TRUE	0	TimeOfDay
23-53	Energy Log	0 N/A	All set-ups	TRUE	0	Uint32
23-54	Reset Energy Log	[0] Do not reset	All set-ups	TRUE	-	Uint8
23-6* Trending						
23-60	Trend Variable	[0] Power [kW]	2 set-ups	TRUE	-	Uint8
23-61	Continuous Bin Data	0 N/A	All set-ups	TRUE	0	Uint32
23-62	Timed Bin Data	0 N/A	All set-ups	TRUE	0	Uint32
23-63	Timed Period Start	ExpressionLimit	2 set-ups	TRUE	0	TimeOfDay
23-64	Timed Period Stop	ExpressionLimit	2 set-ups	TRUE	0	TimeOfDay
23-65	Minimum Bin Value	ExpressionLimit	2 set-ups	TRUE	0	Uint8
23-66	Reset Continuous Bin Data	[0] Do not reset	All set-ups	TRUE	-	Uint8
23-67	Reset Timed Bin Data	[0] Do not reset	All set-ups	TRUE	-	Uint8
23-8* Payback Counter						
23-80	Power Reference Factor	100 %	2 set-ups	TRUE	0	Uint8
23-81	Energy Cost	1.00 N/A	2 set-ups	TRUE	-2	Uint32
23-82	Investment	0 N/A	2 set-ups	TRUE	0	Uint32
23-83	Energy Savings	0 kWh	All set-ups	TRUE	75	Int32
23-84	Cost Savings	0 N/A	All set-ups	TRUE	0	Int32

Table 5.22

5.1.22 24-** Application Functions 2

Par. No. #	Parameter description	Default value (SR = Size related)	4 set-up	Change during operation	Conversion index	Type
24-0* Fire Mode						
24-00	Fire Mode Function	[0] Disabled	2 set-ups	TRUE	-	Uint8
24-01	Fire Mode Configuration	[0] Open-loop	All set-ups	TRUE	-	Uint8
24-02	Fire Mode Unit	ExpressionLimit	All set-ups	TRUE	-	Uint8
24-03	Fire Mode Min Reference	ExpressionLimit	All set-ups	TRUE	-3	Int32
24-04	Fire Mode Max Reference	ExpressionLimit	All set-ups	TRUE	-3	Int32
24-05	Fire Mode Preset Reference	0.00 %	All set-ups	TRUE	-2	Int16
24-06	Fire Mode Reference Source	[0] No function	All set-ups	TRUE	-	Uint8
24-07	Fire Mode Feedback Source	[0] No function	All set-ups	TRUE	-	Uint8
24-09	Fire Mode Alarm Handling	[1] Trip, Critical Alarms	2 set-ups	FALSE	-	Uint8
24-1* Drive Bypass						
24-10	Drive Bypass Function	[0] Disabled	2 set-ups	TRUE	-	Uint8
24-11	Drive Bypass Delay Time	0 s	2 set-ups	TRUE	0	Uint16
24-9* Multi-Motor Funct.						
24-90	Missing Motor Function	[0] Off	All set-ups	TRUE	-	Uint8
24-91	Missing Motor Coefficient 1	0.0000 N/A	All set-ups	TRUE	-4	Int32
24-92	Missing Motor Coefficient 2	0.0000 N/A	All set-ups	TRUE	-4	Int32
24-93	Missing Motor Coefficient 3	0.0000 N/A	All set-ups	TRUE	-4	Int32
24-94	Missing Motor Coefficient 4	0.0000 N/A	All set-ups	TRUE	-3	Int32
24-95	Locked Rotor Function	[0] Off	All set-ups	TRUE	-	Uint8
24-96	Locked Rotor Coefficient 1	0.0000 N/A	All set-ups	TRUE	-4	Int32
24-97	Locked Rotor Coefficient 2	0.0000 N/A	All set-ups	TRUE	-4	Int32
24-98	Locked Rotor Coefficient 3	0.0000 N/A	All set-ups	TRUE	-4	Int32
24-99	Locked Rotor Coefficient 4	0.0000 N/A	All set-ups	TRUE	-3	Int32

Table 5.23

5.1.23 25-** Cascade Controller

Par. No. #	Parameter description	Default value (SR = Size related)	4 set-up	Change during operation	Conversion index	Type
25-0* System Settings						
25-00	Cascade Controller	[0] Disabled	2 set-ups	FALSE	-	UInt8
25-02	Motor Start	[0] Direct on Line	2 set-ups	FALSE	-	UInt8
25-04	Pump Cycling	[0] Disabled	All set-ups	TRUE	-	UInt8
25-05	Fixed Lead Pump	[1] Yes	2 set-ups	FALSE	-	UInt8
25-06	Number Of Pumps	2 N/A	2 set-ups	FALSE	0	UInt8
25-2* Bandwidth Settings						
25-20	Staging Bandwidth	10 %	All set-ups	TRUE	0	UInt8
25-21	Override Bandwidth	100 %	All set-ups	TRUE	0	UInt8
25-22	Fixed Speed Bandwidth	casco_staging_bandwidth (P2520)	All set-ups	TRUE	0	UInt8
25-23	SBW Staging Delay	15 s	All set-ups	TRUE	0	UInt16
25-24	SBW De-staging Delay	15 s	All set-ups	TRUE	0	UInt16
25-25	OBW Time	10 s	All set-ups	TRUE	0	UInt16
25-26	Destage At No-Flow	[0] Disabled	All set-ups	TRUE	-	UInt8
25-27	Stage Function	[1] Enabled	All set-ups	TRUE	-	UInt8
25-28	Stage Function Time	15 s	All set-ups	TRUE	0	UInt16
25-29	Destage Function	[1] Enabled	All set-ups	TRUE	-	UInt8
25-30	Destage Function Time	15 s	All set-ups	TRUE	0	UInt16
25-4* Staging Settings						
25-40	Ramp-down Delay	10.0 s	All set-ups	TRUE	-1	UInt16
25-41	Ramp-up Delay	2.0 s	All set-ups	TRUE	-1	UInt16
25-42	Staging Threshold	ExpressionLimit	All set-ups	TRUE	0	UInt8
25-43	De-staging Threshold	ExpressionLimit	All set-ups	TRUE	0	UInt8
25-44	Staging Speed [RPM]	0 RPM	All set-ups	TRUE	67	UInt16
25-45	Staging Speed [Hz]	0.0 Hz	All set-ups	TRUE	-1	UInt16
25-46	De-staging Speed [RPM]	0 RPM	All set-ups	TRUE	67	UInt16
25-47	De-staging Speed [Hz]	0.0 Hz	All set-ups	TRUE	-1	UInt16
25-5* Alternation Settings						
25-50	Lead Pump Alternation	[0] OFF	All set-ups	TRUE	-	UInt8
25-51	Alternation Event	[0] External	All set-ups	TRUE	-	UInt8
25-52	Alternation Time Interval	24 h	All set-ups	TRUE	74	UInt16
25-53	Alternation Timer Value	0 N/A	All set-ups	TRUE	0	VisStr[7]
25-54	Alternation Predefined Time	ExpressionLimit	All set-ups	TRUE	0	TimeOfDay-WoDate
25-55	Alternate if Load < 50%	[1] Enabled	All set-ups	TRUE	-	UInt8
25-56	Staging Mode at Alternation	[0] Slow	All set-ups	TRUE	-	UInt8
25-58	Run Next Pump Delay	0.1 s	All set-ups	TRUE	-1	UInt16
25-59	Run-on Line Delay	0.5 s	All set-ups	TRUE	-1	UInt16
25-8* Status						
25-80	Cascade Status	0 N/A	All set-ups	TRUE	0	VisStr[25]
25-81	Pump Status	0 N/A	All set-ups	TRUE	0	VisStr[25]
25-82	Lead Pump	0 N/A	All set-ups	TRUE	0	UInt8
25-83	Relay Status	0 N/A	All set-ups	TRUE	0	VisStr[4]
25-84	Pump ON Time	0 h	All set-ups	TRUE	74	UInt32
25-85	Relay ON Time	0 h	All set-ups	TRUE	74	UInt32
25-86	Reset Relay Counters	[0] Do not reset	All set-ups	TRUE	-	UInt8

Par. No. #	Parameter description	Default value (SR = Size related)	4 set-up	Change during operation	Conversion index	Type
25-9* Service						
25-90	Pump Interlock	[0] Off	All set-ups	TRUE	-	Uint8
25-91	Manual Alternation	0 N/A	All set-ups	TRUE	0	Uint8

Table 5.24

5.1.24 26-** Analog I / O Option MCB 109

Par. No. #	Parameter description	Default value (SR = Size related)	4 set-up	Change during operation	Conversion index	Type
26-0* Analog I/O Mode						
26-00	Terminal X42/1 Mode	[1] Voltage	All set-ups	TRUE	-	Uint8
26-01	Terminal X42/3 Mode	[1] Voltage	All set-ups	TRUE	-	Uint8
26-02	Terminal X42/5 Mode	[1] Voltage	All set-ups	TRUE	-	Uint8
26-1* Analog Input X42/1						
26-10	Terminal X42/1 Low Voltage	0.07 V	All set-ups	TRUE	-2	Int16
26-11	Terminal X42/1 High Voltage	10.00 V	All set-ups	TRUE	-2	Int16
26-14	Term. X42/1 Low Ref./Feedb. Value	0.000 N/A	All set-ups	TRUE	-3	Int32
26-15	Term. X42/1 High Ref./Feedb. Value	100.000 N/A	All set-ups	TRUE	-3	Int32
26-16	Term. X42/1 Filter Time Constant	0.001 s	All set-ups	TRUE	-3	Uint16
26-17	Term. X42/1 Live Zero	[1] Enabled	All set-ups	TRUE	-	Uint8
26-2* Analog Input X42/3						
26-20	Terminal X42/3 Low Voltage	0.07 V	All set-ups	TRUE	-2	Int16
26-21	Terminal X42/3 High Voltage	10.00 V	All set-ups	TRUE	-2	Int16
26-24	Term. X42/3 Low Ref./Feedb. Value	0.000 N/A	All set-ups	TRUE	-3	Int32
26-25	Term. X42/3 High Ref./Feedb. Value	100.000 N/A	All set-ups	TRUE	-3	Int32
26-26	Term. X42/3 Filter Time Constant	0.001 s	All set-ups	TRUE	-3	Uint16
26-27	Term. X42/3 Live Zero	[1] Enabled	All set-ups	TRUE	-	Uint8
26-3* Analog Input X42/5						
26-30	Terminal X42/5 Low Voltage	0.07 V	All set-ups	TRUE	-2	Int16
26-31	Terminal X42/5 High Voltage	10.00 V	All set-ups	TRUE	-2	Int16
26-34	Term. X42/5 Low Ref./Feedb. Value	0.000 N/A	All set-ups	TRUE	-3	Int32
26-35	Term. X42/5 High Ref./Feedb. Value	100.000 N/A	All set-ups	TRUE	-3	Int32
26-36	Term. X42/5 Filter Time Constant	0.001 s	All set-ups	TRUE	-3	Uint16
26-37	Term. X42/5 Live Zero	[1] Enabled	All set-ups	TRUE	-	Uint8
26-4* Analog Out X42/7						
26-40	Terminal X42/7 Output	[0] No operation	All set-ups	TRUE	-	Uint8
26-41	Terminal X42/7 Min. Scale	0.00 %	All set-ups	TRUE	-2	Int16
26-42	Terminal X42/7 Max. Scale	100.00 %	All set-ups	TRUE	-2	Int16
26-43	Terminal X42/7 Bus Control	0.00 %	All set-ups	TRUE	-2	N2
26-44	Terminal X42/7 Timeout Preset	0.00 %	1 set-up	TRUE	-2	Uint16
26-5* Analog Out X42/9						
26-50	Terminal X42/9 Output	[0] No operation	All set-ups	TRUE	-	Uint8
26-51	Terminal X42/9 Min. Scale	0.00 %	All set-ups	TRUE	-2	Int16
26-52	Terminal X42/9 Max. Scale	100.00 %	All set-ups	TRUE	-2	Int16
26-53	Terminal X42/9 Bus Control	0.00 %	All set-ups	TRUE	-2	N2
26-54	Terminal X42/9 Timeout Preset	0.00 %	1 set-up	TRUE	-2	Uint16
26-6* Analog Out X42/11						
26-60	Terminal X42/11 Output	[0] No operation	All set-ups	TRUE	-	Uint8
26-61	Terminal X42/11 Min. Scale	0.00 %	All set-ups	TRUE	-2	Int16
26-62	Terminal X42/11 Max. Scale	100.00 %	All set-ups	TRUE	-2	Int16
26-63	Terminal X42/11 Bus Control	0.00 %	All set-ups	TRUE	-2	N2
26-64	Terminal X42/11 Timeout Preset	0.00 %	1 set-up	TRUE	-2	Uint16

Table 5.25

Index

>
>Mains Power On/Off..... 2-90

A
Abbreviations..... 0-2

Alarm
Log..... 2-100
Words..... 3-5

Alarm/Warning Code List..... 3-3

Alarms And Warnings..... 3-1

Analog
Input Scaling Value..... 2-175
Inputs..... 0-3, 3-8

Auto
Derate..... 2-95
Energy Optimization Compressor..... 2-14
Energy Optimization VT..... 2-14

B
BACnet..... 2-65

Braking
Braking..... 3-10
Energy..... 0-4

Break-away Torque..... 0-3

Broken Belt Detection..... 2-139

Bus Controlled..... 2-52

C
Cascade Controller..... 2-161

Changes Made..... 1-8

Changing
A Group Of Numeric Data Values..... 1-14
A Text Value..... 1-14
Data..... 1-14
Parameter Data..... 1-7

Coast Inverse..... 1-9

Coasting..... 0-3, 1-4

Communication Option..... 3-11

Compressor Start Max Speed [rpm]..... 2-24

Configuration..... 2-61

Cooling..... 2-26

Copyright, Limitation Of Liability And Revision Rights..... 0-1

Current
Limit Control..... 2-93
Rating..... 3-8

D
Data Log Settings..... 2-97

DC Link..... 3-8

Default Settings..... 4-1, 1-15

Definitions..... 0-3

Derating..... 3-8

DeviceNet
DeviceNet..... 2-73
And CAN Serial Communications Bus..... 2-73

Digital Input..... 3-9

Drive
Bypass..... 2-158
Identification..... 2-100
Information..... 2-97

E
End Of Curve..... 2-138

Energy
Log..... 2-149
Optimizing..... 2-94

Environment..... 2-94

ETR..... 2-104

Example Of Changing Parameter Data..... 1-7

Extended
CL Autotuning..... 2-123
Status Word..... 3-7
Status Word 2..... 3-7

F
Fault Messages..... 3-8

FC Closed-loop..... 2-112

Feedback
Feedback..... 3-11, 2-112, 3-13
& Setpoint..... 2-115
Adv. Conversion..... 2-118

Fire Mode..... 2-155

Flow Compensation..... 2-140

Freeze Output..... 0-3

Function Set-ups..... 1-9

Fuses..... 3-11

G
Graphical Display..... 1-1

H
Historic Log..... 2-99

How To Operate The GraphicalLCP (GLCP)..... 1-1

I	
Indicator Lights (LEDs).....	1-3
Initialization.....	1-15
Input Terminals.....	3-8
J	
Jog.....	0-3
L	
Language	
Package 1.....	2-2
Package 2.....	2-2
LCP 102.....	1-1
LEDs.....	1-1
Line Power Supply.....	0-5
Literature.....	0-2
Local Reference.....	2-3
Loggings.....	1-8
LonWorks.....	2-77
M	
Main	
Menu - Drive Information - Group 15.....	2-97
Menu Mode.....	1-3, 1-7, 1-13
Menu Structure.....	2-1
Reactance.....	2-18
Manual Initialization.....	1-15
Motor	
Current.....	3-8, 3-12
Data.....	3-9, 3-12
Power.....	3-12
Protection.....	2-26
Status.....	2-103
N	
NLCP.....	1-5
No	
Operation.....	1-9
Trip At Inverter Overload.....	2-95
O	
Operating Mode.....	2-3
Option Ident.....	2-101
Output Current.....	3-8
P	
Parameter	
Access.....	2-76
Data.....	1-7
Info.....	2-101
Options.....	4-1
Selection.....	1-13
Set-up.....	1-7
Password.....	2-11
PID	
Autotuning.....	2-119
Basic Settings.....	2-121
Controller.....	2-121
Programming.....	3-8
Protection Mode.....	0-6
Q	
Quick	
Menu.....	1-3
Menu Mode.....	1-3, 1-7
Transfer Of Parameter Settings Between Multiple Adjustable Frequency Drives.....	1-6
R	
Rated Motor Speed.....	0-3
RCD.....	0-4
Readout And Programming Of Indexed Parameters.....	1-15
Relay Outputs.....	2-45
Reset.....	3-8, 3-13
S	
Safety Precautions.....	0-5
Serial Communication.....	0-3
Short Cycle Protection.....	2-139
Sleep Mode.....	2-135
Software Version.....	0-1
Start	
Delay.....	2-23
Function.....	2-23
Stator Leakage Reactance.....	2-18
Status	
Status.....	1-3
Messages.....	1-1
Step-by-Step.....	1-15
Supply Voltage.....	3-11
Switching Frequency.....	3-8
Symbols.....	0-1
Synchronous Motor Speed.....	0-3

T**Thermal Load**..... 2-104**Thermistor**..... 2-26, 3-9, 0-5**Timed Actions**..... 2-144**Trending**..... 2-151**Trip** **At Motor Speed Low Limit**..... 2-25 **Reset**..... 2-92**Troubleshooting**..... 3-8, 3-1**V****Value**..... 1-15**VCplus**..... 0-5**W****Warning Words**..... 3-6



www.danfoss.com/drives

Danfoss shall not be responsible for any errors in catalogs, brochures or other printed material. Danfoss reserves the right to alter its products at any time without notice, provided that alterations to products already on order shall not require material changes in specifications previously agreed upon by Danfoss and the Purchaser. All trademarks in this material are property of the respective companies. Danfoss and the Danfoss logotype are trademarks of Danfoss A/S. All rights reserved.

Danfoss Drives

4401 N. Bell School Rd.
Loves Park IL 61111 USA
Phone: 1-800-432-6367
1-815-639-8600
Fax: 1-815-639-8000
www.danfossdrives.com

Danfoss Drives

8800 W. Bradley Rd.
Milwaukee, WI 53224 USA
Phone: 1-800-621-8806
1-414-355-8800
Fax: 1-414-355-6117
www.danfossdrives.com

