



# **BOILER ROOM GUIDE**

## FOREWORD

This guide is provided to assist supervisory, operating and maintenance personnel in understanding the operation of boiler room equipment, and to provide guidance to achieve safe and efficient operation of the equipment.

Automatic features provided in the design of boiler room equipment relieves the operator from mundane and repetitive tasks, but routine maintenance of all of the equipment is never to be neglected by the operators or maintenance personnel.

The information provided in this guide is for general guidance in proper equipment operation and maintenance. The operation maintenance and parts manual for a specific piece of equipment should be reviewed for details and safety requirements. No attempt should be made to operate equipment until the principles of operation and all of the components are thoroughly understood. Failure to follow all applicable instructions and warnings may result in personal injury or damage to the equipment.

Because of the multiplicity of national, state, local, or other applicable codes pertaining to the design, manufacture, installation and operation of steam and hot water boilers, no attempt will be made in this guide to set any mandatory rules. The operation of this equipment by the owner and his/her operating personnel must comply with all requirements or regulations of his/her insurance company and/or any other authority having jurisdiction. These requirements take precedence over anything contained herein.

# TABLE OF CONTENTS

## CHAPTER 1 GENERAL BOILER DESCRIPTION

THE FIRETUBE BOILER . . . . .	1-1
THE WATERTUBE BOILER . . . . .	1-2
PACKAGED BOILERS . . . . .	1-2
FIELD ERECTABLE BOILERS . . . . .	1-3
THREE PASS FIRETUBE BOILERS . . . . .	1-4
OTHER BOILER DESIGNS . . . . .	1-4
REGULATORY CODES . . . . .	1-5
GENERAL ACCESSORY EQUIPMENT . . . . .	1-6
HEAT RECOVERY EQUIPMENT . . . . .	1-6
ECONOMIZERS . . . . .	1-7
BLOWDOWN EQUIPMENT . . . . .	1-7
FLASH TANK HEAT EXCHANGER . . . . .	1-8
BLOWDOWN SEPARATOR . . . . .	1-8
SAMPLE COOLER . . . . .	1-9
BOILER FEEDWATER EQUIPMENT . . . . .	1-9
DEAERATORS . . . . .	1-9
FEED SYSTEMS . . . . .	1-10
SURGE TANKS . . . . .	1-10
PRE-TREATMENT EQUIPMENT . . . . .	1-11
WATER SOFTENER . . . . .	1-11
CHEMICAL FEEDERS . . . . .	1-12
FLAME SAFEGUARD EQUIPMENT . . . . .	1-13
STACKS . . . . .	1-14
O <sub>2</sub> (OXYGEN) TRIM . . . . .	1-14

## CHAPTER 2 INSPECTIONS

NEW BOILER INSTALLATIONS . . . . .	2-1
HYDROSTATIC TESTING . . . . .	2-2
EXISTING BOILER INSTALLATIONS . . . . .	2-4
WATER SIDE INSPECTION . . . . .	2-4
FIRESIDE INSPECTION . . . . .	2-5
EXTERNAL INSPECTION . . . . .	2-6
NEW OR EXISTING INSTALLATIONS . . . . .	2-6
Burner And Controls . . . . .	2-6
Operating Limits & Interlocks . . . . .	2-7
Auxiliary Equipment . . . . .	2-7
Economizers . . . . .	2-7
Pumps . . . . .	2-8
Blowdown Heat Recovery . . . . .	2-8
Sample Cooler . . . . .	2-8
Deaerator/Surge Tank/Packaged Feed Systems . . . . .	2-8

Filters . . . . .	2-9
Water Softener/Dealkalizer/Reverse Osmosis . . . . .	2-9
Chemical Feeders . . . . .	2-9
Economizers . . . . .	2-9

## CHAPTER 3 ORIGINAL STARTUP

INITIAL STARTUP FOR A NEW BOILER . . . . .	3-1
FIRETUBE BOILER BOILOUT . . . . .	3-2
Washing Out Pressure Vessel (Steam). . . . .	3-3
Washing Out Pressure Vessel (Hot Water) . . . . .	3-3
WATERTUBE BOILOUT. . . . .	3-4
Steam And Hot Water Boilers . . . . .	3-4
FIRING UP. . . . .	3-6
BOILER CONTROLS . . . . .	3-7
Flame Safeguard. . . . .	3-7
Gas Pilot Flame Adjustment . . . . .	3-8
High Limit Control. . . . .	3-8
Operating Limit Control. . . . .	3-8
Modulating Control . . . . .	3-8
Atomizing Media Pressure Switch . . . . .	3-8
Low Fire Hold Control. . . . .	3-8
Low Water Cutoff . . . . .	3-9
Auxiliary Low Water Cutoff . . . . .	3-9
Low Gas Pressure Switch. . . . .	3-10
High Gas Pressure Switch . . . . .	3-10
Combustion Air Proving Switch. . . . .	3-10
Low Oil Temperature Switch . . . . .	3-11
High Oil Temperature Switch. . . . .	3-11
Low Oil Pressure Switch . . . . .	3-11
Bringing Boilers On Line . . . . .	3-11

## CHAPTER 4 ROUTINE OPERATION

NORMAL OPERATION . . . . .	4-1
Boiler Room Care . . . . .	4-1
Basic Record System . . . . .	4-2
Daily Maintenance. . . . .	4-4
Weekly Maintenance. . . . .	4-5
Monthly Maintenance . . . . .	4-5
Semi-Annual Maintenance . . . . .	4-6
Annual Maintenance . . . . .	4-7
Boiler Room Log. . . . .	4-8
Low Water Cutoff . . . . .	4-9
Safety And Relief Valves . . . . .	4-10
Burner And Controls. . . . .	4-12
Feedwater Treatment . . . . .	4-13

Boiler Blowdown . . . . .	4-13
Deaerator . . . . .	4-15
The Economizer . . . . .	4-16
Feedwater Pump(s). . . . .	4-17
Fuel Systems . . . . .	4-17

## CHAPTER 5 SHUTTING DOWN

GENERAL . . . . .	5-1
WET STORAGE. . . . .	5-3
DRY STORAGE. . . . .	5-4

## CHAPTER 6 THEORY OF COMBUSTION AND THERMODYNAMICS

INTRODUCTION . . . . .	6-1
THEORY OF COMBUSTION . . . . .	6-2
Effects of air properties . . . . .	6-6
BASICS OF THERMODYNAMICS . . . . .	6-7
Law of Energy Conservation . . . . .	6-7
Latent Heat of Fusion, Evaporation and Condensation . . . .	6-7
Analysis of Temperature - Heat Diagram For Water At Constant Pressure . . . . .	6-10
Rated Boiler Output . . . . .	6-12
Factor of Evaporation . . . . .	6-12
Abbreviations . . . . .	15

# CHAPTER 1

## GENERAL BOILER DESCRIPTION

There is a variety of boiler design concepts available in the marketplace. The material contained in this guide is directed at users of equipment for commercial or industrial applications. Boilers for these applications are generally of the firetube design or watertube design concepts.

### THE FIRETUBE BOILER

The firetube boiler design (see Figures 1-1 & 1-2) uses tubes to direct the hot gases from the combustion process through the boiler to a safe point of discharge. The tubes are submerged in the boiler water and transfer the heat from the hot gases into the water.

Inside a firetube boiler the hot gases travel down the furnace during the combustion process, (first pass). The rear head seals the gases in the lower portion of the head. The gas is redirected through the second pass tubes. In the front head the hot gases are sealed from escaping out the stack and turned and redirected through the third pass tubes. The hot gas travels toward the upper portion of the rear head where it's turned and directed through the fourth pass tubes. From there, after giving up most of the energy from the combustion process, the gas is directed into the stack and vented to the atmosphere.

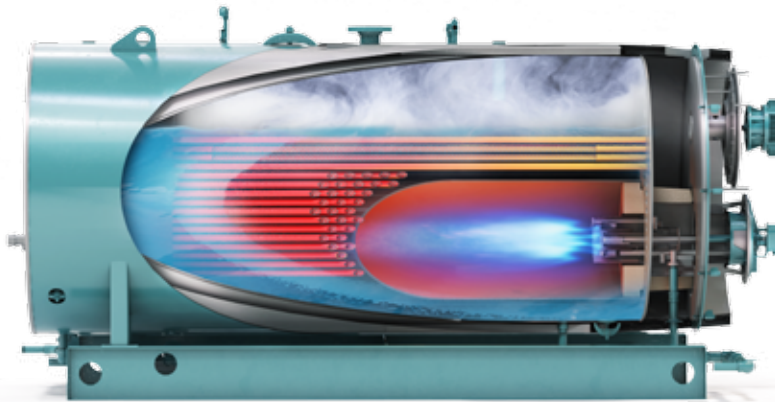

Figure 1-1: Firetube Cut-Away

FRONT HEAD WITH  
MOTOR, CONTROLS,  
LINKAGE AND BURNER

GAS TRAIN

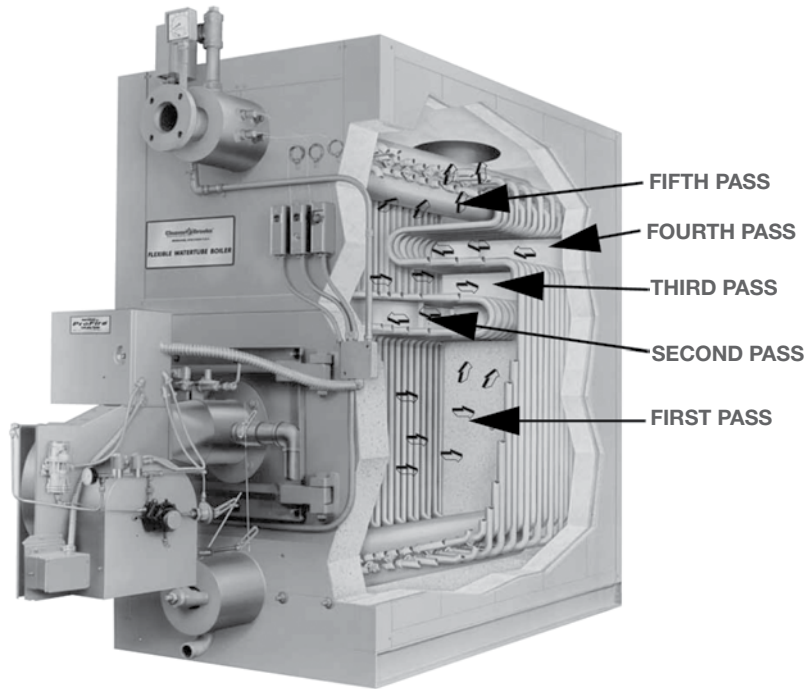

Figure 1-2: Firetube Boiler, CBLE

OIL PIPING

## THE WATERTUBE BOILER

The watertube boiler design (see Figures 1-3 & 1-4) uses tubes to direct the boiler water through the hot gases from the combustion process, allowing the hot gases to transfer its heat through the tube wall into the water. The boiler water flows by convection from the lower drum to the upper drum.



**Figure 1-3: Commercial Watertube Cut-Away**



**Figure 1-4: Commercial Watertube (FLX)**

Either of the firetube or watertube boiler design concepts is available in what is popularly known as the packaged boiler, a concept introduced by Cleaver-Brooks in 1931. A packaged boiler is shipped from the manufacturer as a complete assembly, with burner, control systems, operating and safety controls, all piped and/or wired into the assembly. Equipment of this type needs only to be positioned into its intended location, utility connections made and a means provided to direct the flue gases to a safe point of discharge.

## PACKAGED BOILERS

Most packaged firetube boilers are available in capacities of 500,000 Btu/hr up to 26,800,000 Btu/hr output. These boilers are normally rated on the basis of boiler horsepower (BHP) output. One boiler horsepower = 33,472 Btu per hour.

Packaged watertube boilers, designed for commercial applications, are normally available in sizes as small as 1,200,000 Btu/hr output. (See Figures 1-3 & 1-4)

Industrial watertube boilers can be provided in packaged format in capacities of up to 134,000,000 Btu/hr. (see Figures 1-3 & 1-4)



*Figure 1-5: Industrial Watertube*

## **FIELD ERECTABLE BOILERS**

Boilers that are not provided in packaged form can be delivered to the job site in pieces for assembly in the boiler room by people with the various skills required. Industrial watertube boilers can be field erected (see Figure 1-5) but, in most cases, smaller boilers of both watertube and firetube concept are available for field assembly. The parts would include a shell, drums or headers and tubes, which would be erected onto a brick or water-cooled, wall-combustion chamber. A burner system, boiler and burner controls are then piped and/or wired into the assembly at the job site.

## THREE PASS FIRETUBE BOILERS

Firetube boiler designs can vary significantly. Various tube and furnace arrangements have been developed to maximize boiler efficiency and pressure vessel longevity. One of the primary variations occurs in the arrangement of the firetubes. Designs are available to provide for 2, 3, or 4 gas passes. Furnaces can be located high or low within the boiler shell. Boilers are available as dry back or wet back (water cooled gas reversal area). The popular Cleaver-Brooks design includes 3 or 4 gas passes with a low furnace location for optimum thermal efficiency (see Figure 1-6), and dry back or wet back arrangement.

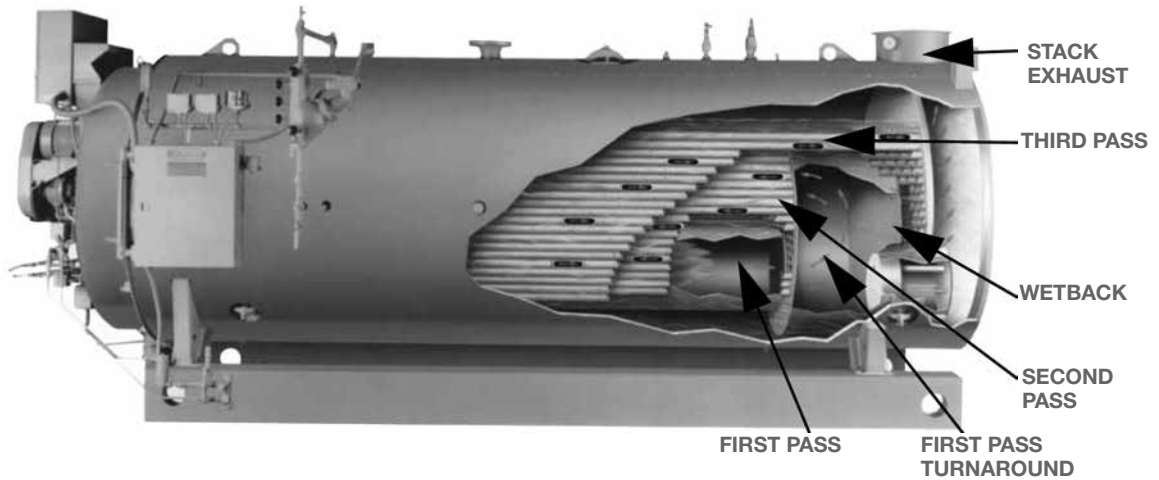

*Figure 1-6: Three Pass, Wetback Cut-Away*

## OTHER BOILER DESIGNS

There is a variety of other boiler design concepts available. For example, cast iron sectional boilers, usually limited to smaller output capacities. There are vertical boilers (see Figure 1-7) of several designs. These boilers are frequently used when floor area is quite limited and where sufficient height in the boiler room is available. Electric boilers (see Figure 1-8) are available for those sites where electric energy is low cost.

Vertical and electric boilers are not as commonly used as the firetube and watertube design concepts, for various reasons. However, where they are used, they require the same kinds of maintenance and care instructions which are provided in this guide. The procedures may vary for each design concept but the end result should be the same. The manufacturer's operation and maintenance manual recommendations should always take precedence when a conflict of instructions appear in this guide.



*Figure 1-7: Vertical Boiler, ClearFire®-V*



*Figure 1-8: Electric Boiler, WB*



*Horizontal Boiler, ClearFire®-H*



*Condensing Boiler, ClearFire®-C*

## REGULATORY CODES

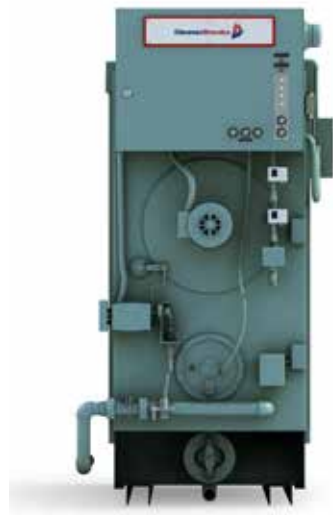

*Figure 1-9: Model 4 Pressure Vessel*

Fabricated steel boilers that are manufactured for installation in the United States are designed to comply with one or more of the codes which were written by the American Society of Mechanical Engineers (ASME). Some of the codes relate primarily to the boiler pressure vessel see (Figures 1-9 and 1-10). When the fabricated pressure vessel has been completed in accordance with all facets of the applicable code, it receives a compliance stamp including the proper ASME symbol.

The tenets of the ASME codes are widely accepted, but, in some nations, some minor deviations are required, usually in the area of connection sizes and type.

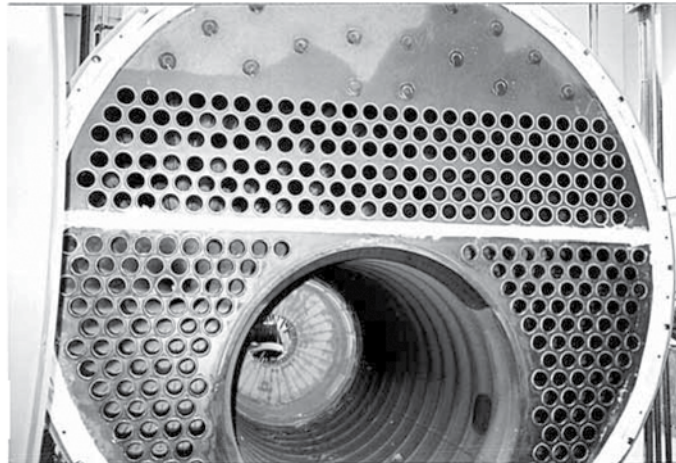

*Figure 1-10: Firetube Pressure Vessel, Rear Door Open*

Combustion hardware and burner control systems can be regulated by ASME code, CSD-1. Other approval bodies, such as Underwriters Laboratories, Canadian Standards Association, American Gas Association, etc., also could be a regulating body.

Heating boilers are fabricated in accordance with Section IV of the ASME Code. The limits established by Section IV for boiler design are:

- For steam - operating at pressures not exceeding 15 psi.
- For hot water - operating at pressures not exceeding 160 psi and/or temperatures not exceeding 250°F at or near the boiler outlet. Standard controls normally limit the maximum temperature to 240°F.

Process boilers, called “power boilers,” are fabricated in accordance with Section I of the ASME Code. Section I applies to all steam boilers above 15 psi or 250°F/160 psi hot water boilers. The most common design pressures are 150, 200, 250, 300 and 350 psi.

Boilers that generate steam from an external source of energy, commonly referred to as waste heat boilers, are fabricated in accordance with Section VIII of the ASME Code. Deaerators, surge tanks or other pressurized tanks, referred to as unfired pressure vessels, are also fabricated to Section VIII.

Insurance carriers such as Factory Mutual, Industrial Risk Insurance, Kemper, etc., could also have an impact on a specific installation.

## GENERAL ACCESSORY EQUIPMENT

There are many types of accessory or auxiliary equipment that could be required in the operational boiler room system (see Figure 1-11). Some of the equipment is to improve overall system efficiency, some to protect the boiler and system from corrosion, and some to reduce the problem of scale from building-up in the boiler. However, not every piece of equipment is required in every installation.



*Figure 1-11: Operational Boiler Room*

## HEAT RECOVERY EQUIPMENT

Heat recovery equipment is available to preheat feedwater entering the boiler (economizer) and to capture Btu's lost through boiler blowdown (blowdown heat recovery or flash tank heat exchangers). Such equipment is normally used on installations where boiler size, operating pressures or the amount of water make-up justify the economics for the purchase and installation costs (normally units exceeding 100 hp and operating at 100 psi or more). Maintenance costs also must be considered before a decision is made for their installation.

## ECONOMIZERS



*Figure 1-12: Stack Economizer*

Economizers are bent, finned-tube heat exchangers. They are available in rectangular or cylindrical (see Figure 1-12) styles. The type of boiler and the overall boiler room layout may dictate which style is utilized.

The boiler feedwater flows through the economizer tubes before it enters the boiler. The economizer is installed into the breeching between the flue gas outlet connection on the boiler and the stack. The products of combustion leaving the boiler flow through the economizer, over the finned tubes, transferring its heat or Btu's to the boiler feedwater. The efficiency of the overall system can be increased by 2% to 4%, depending on fuel being burned, boiler size, and operating conditions.

## BLOWDOWN EQUIPMENT

There are several methods and equipment used in blowdown heat recovery. In most cases, the systems are used on continuous or surface blowdown to control the Total Dissolved Solids (TDS) in the boiler water.

Blowdown heat recovery equipment is used for automatic control of the continuous blowdown, based on water make-up (see Figure 1-13) and cools the continuous blowdown to a point where it can be safely dumped to the sewer system. It transfers heat or Btu's to the make-up water, thus raising the temperature of the make-up water before it enters the deaerator or boiler feed system.



*Figure 1-13: Blowdown Heat Recovery*

## FLASH TANK HEAT EXCHANGER

Another system uses the addition of a flash tank heat exchanger (see Figure 1-14). This system works on the same principle as the blowdown heat recovery system, however, it also provides the benefit of flash steam. This flash steam can be reused in the plant, such as being piped to a deaerator and mixed with the incoming steam in the deaerator.



*Figure 1-14: Flash Tank Heat Exchanger*

## BLOWDOWN SEPARATOR

An additional piece of equipment - the blowdown separator - can be installed for bottom blowdown (see Figure 1-15). The blowdown separator reduces the temperature of the bottom blowdown water to a temperature that would be safe for the sewer system. However, because of the erratic flow of bottom blowdown, there is little benefit to use a blowdown separator as a means to raise the temperature of make-up water prior to entering the deaerator or boiler feed system.



*Figure 1-15: Blowdown Separator and Cut-Away*

## **SAMPLE COOLER**

During daily operation of a plant, a sample cooler is normally required to draw samples of boiler water, so chemical tests can be performed. The boiler water, however, is above the temperature that test equipment can handle. In most cases, the situation is resolved with the installation of a sample cooler (see Figure 1-19).



*Figure 1-16: Sample Cooler*

## **BOILER FEEDWATER EQUIPMENT**

Boiler feedwater usually contains two harmful dissolved gases: Oxygen and Carbon Dioxide. If the dissolved gases are not removed before entering the boiler, they will be liberated by heat and may cause severe corrosion in the boiler, steam lines, condensate lines, and heat transfer equipment, which can prove to be very costly. The dissolved oxygen and carbon dioxide can be removed with chemicals. Depending on the overall system, it may not be practical to chemically remove the dissolved oxygen and carbon dioxide from the feedwater. In these cases, a deaerator should be installed. Because the deaerator mechanically removes dissolved oxygen and carbon dioxide, the amount of chemicals required could be reduced.

## **DEAERATORS**

The deaerator is a pressurized ASME tank and may be the largest piece of auxiliary equipment in the boiler room. A deaerator is designed to heat water to the temperature of saturated steam at the pressure within the deaerator. A deaerator provides an effective means for recovery of heat from exhaust or flash steam, provides a location for returning condensate and accepts condensate first to reduce excessive make-up water. There are three types of deaerators available. The tray type is normally used in large utility plants. Applications that use a deaerator with a packaged boiler typically use a packed column (see Figure 1-20) or spray type (see Figure 1-21) deaerator.



*Figure 1-17: Boilermate Deaerator*



*Figure 1-18: Spraymaster Deaerator*

## FEED SYSTEMS

If plant conditions do not warrant the use of a deaerator, in most cases, a Packaged Feed System is used. The packaged feed system is an atmospheric tank that can heat feedwater to a maximum of 210°F.

Because they are atmospheric tanks, they are equipped with an epoxy lining or made from galvanized steel. The packaged feed system heats the feedwater and reduces the amount of dissolved oxygen and carbon dioxide in the feedwater. However, it's not as efficient as a deaerator and, therefore, more chemicals will be required to protect the overall system.

There are many additional pieces of equipment available to remove impurities in the make-up water before it enters the boiler and system. The type of equipment required is determined by a water analysis. This equipment can be classified as pre-treatment equipment.



*Figure 1-19: Feed Water System*



*Figure 1-20: Surge Tank*

## **SURGE TANKS**

A surge tank could be used under the following conditions: If there are intermittent peak loads of condensate that can exceed the surge capacity of the deaerator - varying pressures or temperatures in condensate - gravity or pumped condensate that have insufficient pressure to enter the deaerator on their own (see Figure 1-19). Surge tanks are atmospheric and accept condensate and make-up water before it goes to the deaerator. Surge tanks can be lined with an epoxy coating to prevent corrosion. The condensate and make-up water mix into a blend temperature as determined by the percentage of each.

## PRE-TREATMENT EQUIPMENT

Filters (see Figure 1-21) are available to remove free chlorine, some dissolved organics and sediment. They can also remove suspended solids, colloidal matter, sand and iron.

There are carbon filters, multilayered filters, sand or iron filters. There can be lined tanks, ASME code tanks and automatic operation based on a time clock, pressure differential switch or water meter. They can protect such items as water softeners, dealkalizers, and reverse osmosis equipment, etc.



*Figure 1-21: Water Filter*



*Figure 1-22: Water Conditioners*

## WATER SOFTENER

There are many different types of water softening systems available today. No attempt will be made in this section to explain the operation of them all. Probably the most popular and widely used type of water softening method is the sodium zeolite softening process (see Figure 1-22), more commonly referred to as zeolite softening. This type of softening process will remove the calcium and magnesium salts from water and reduce it to zero hardness. Through an ion exchange process, water softeners remove hardness and replace it with highly soluble sodium ions; thus preventing scale buildup on heat transfer surfaces. Removing hardness also reduces the need for chemical treatment used to control scale. A water softener can be single or multiple tank and automatic or manual operation.

The zeolite type of softening process can be used in conjunction with other external or internal treatment processes or equipment for boilers. Other types of equipment that could be in a system are:

1. Dealkalizer - Employ an ion exchange to reduce Bicarbonate Alkalinity. It replaces bicarbonate, sulfate, nitrate, and silica with chloride ions.
2. Reverse Osmosis Units - This type of unit is used to reduce dissolved solids in make-up water. The unit uses a semi-permeable membrane that allows water to flow through it and at the same time restricts the flow of dissolved solids. The dissolved solids remain in solution and are carried out of the unit to waste.

While the amount of chemicals added to a boiler and system can be reduced with the use of pre-treatment equipment, chemicals still have to be added. Chemicals are normally added with the use of chemical feeders.

**Note: Contrary to common belief, hot water boilers often require treatment to a limited degree.**

## CHEMICAL FEEDERS

There are several different methods that can be utilized to feed chemicals into a boiler. However, there are two basic types and most chemical feed equipment can be classed in one or the other.

First and simplest is the pot type Manual Shot Feeder. Pot type feeders are frequently installed in small boiler plants, on the discharge side of the boiler feed pump. The feeder is convenient and economical for the injection of precipitating chemicals in closed loop or low make-up systems.

The second group of chemical feeders is the Chemical Feed System (see Figure 1-25) and Metering Pumps. These systems provide for feeding chemicals into a boiler at a predetermined and controlled rate.

Chemicals for oxygen removal, pH adjustment or any of the surface active organic and inorganic chemicals for prevention of deposits or corrosion in distribution lines, would normally be added to the system with this type of arrangement.

Depending upon the degree of sophistication, this type of system could include a chemical tank, pump, complement of valves, piping, etc., plus some type of control mechanism, timer or meter.



*Figure 1-24 Chemical Feed System*

## FLAME SAFEGUARD EQUIPMENT

The Flame Safeguard or Programming Control on boilers are designed to ensure that the start-up of the burner follows a definite timed sequence of operation. In addition to the sequence of operation and after the flame has been established, the Flame Safeguard monitors the flame and sets the firing rate of the burner, as determined by the boiler firing rate controls. They also monitor, through the boiler controls, items such as boiler pressure or temperature, fuel pressure or temperature and they provide for normal shut down of the burner if the load demand is satisfied, or shut down and alarm if there is a safety shut down condition.



**Figure 1-13: HAWK PLC  
Boiler Management Control**

The Flame Safeguards or Programming Control installed on a boiler can be classified into three categories:

1. Electro Mechanical
2. Solid State Electronic
3. Micro Processor

The electro mechanical controls have been used from around 1950 until 1984.

Solid state electronic controls were introduced in 1984. This type of control provides for more alarm or monitoring functions than the electro mechanical controls. The micro processor controls (see Figure 1-23) introduced in 1989 not only provide the functions as the other controls, but also have the ability to send information to computers and work in conjunction with some energy management systems. The micro processor type of controls are standardly furnished on some of today's modern boilers.

# CHAPTER 2

## INSPECTIONS

### NEW BOILER INSTALLATIONS

Before a new boiler is initially fired, it should be given a complete and thorough inspection on both the fire side and water side. Examination is necessary of all the pressure parts, drums, tubes, water column(s), blowoff and blowdown valves, safety or safety relief valves, baffles, nozzles, refractory setting, seals, insulation, casing, etc. If any foreign material is found in the boiler, it should be removed.

The period of initial inspection is also a good time for the insurance inspector to check out the boiler. As a general rule, the inspectors like to have an opportunity to inspect the boiler prior to the hydrostatic test. Any state or local inspectors, when required, should also be contacted.



*Figure 1-25: Industrial Watertube Installation*

Note: All electrical service to the boiler must be disconnected and locked into the off position. It is suggested that only low voltage portable lighting be used for internal boiler inspections. Only approved, properly guarded extension cords with waterproof fittings should be used, and all connections are to be made exterior to the boiler. Light bulbs should be equipped with explosion-proof guards. All federal, state, local or insurance codes regarding confined space requirements or lock out of electrical equipment, or valves in steam lines, fuel lines, and water lines, must be followed.

## HYDROSTATIC TESTING

When a hydrostatic test is required in order to comply with state, local or insurance company requirements, a series of actions are necessary. It first must be determined if the hydrostatic test will be at 1-1/2 times the operating pressure or 1-1/2 times the design or maximum allowable working pressure. Boilers are hydrostatically tested during manufacturing at 1-1/2 times the design or maximum allowable working pressure and the Manufacturer's Data Report (H-2 Section IV Boilers or P-2 Section I Boilers) is completed. A job site hydrostatic test is normally at 1-1/2 times the operating pressure, or below the safety valve settings, and is done to determine if any tube connections were loosened during shipment. However, some installations require a hydrostatic test at 1-1/2 times the design or maximum working pressure. Depending on which test is required and the juristic body involved, some of the following may be applicable:

1. Safety valves may have to be removed (see Figure 2-2) and blind flanges installed over the openings. If safety valves are equipped with threaded inlets, they may be removed and the boiler openings can be plugged.
2. The safety valves may be gagged. However, this method is not a normally recommended practice. The gag should be used only for the hydrostatic test and must be removed as soon as the test is completed. The gag should be installed on the valve and extreme care should be exercised not to tighten the gag screw too tightly. Hand tight torque is generally sufficient. Damage to the spindle and/or seat of the valve may result if the gag is too tight. After safety valves have been gagged for the hydrostatic test and if there is any doubt about their operation, the valves should be removed and sent to an authorized testing facility and tested before the boiler is put into operation.
3. Blowoff valves, blowdown valves, non-return valves and other isolating valves should all be closed tight. All lines leading to or from the boiler that lead to any equipment that might be damaged by the hydrostatic pressure should be blocked off either by valves or by disconnecting and capping the piping. Water column(s), gauge glass(es), continuous blowdown lines, chemical feed lines, pressure control lines, drain lines, etc., should all be checked and isolated if necessary. All blowdown and drain lines should be piped to a point of safe discharge. The vent valve on top of the boiler, the steam pressure gauge, water column, and the water fill line should be the only lines not plugged or blocked off. The steam pressure gauge may need to be checked and calibrated with a dead weight tester.





**Figure 1-27: Water Column and Vent Valve**

With the vent valve on top of the boiler open, or in the water column piping (see Figure 2-3) open, water can now be fed into the boiler. Water used for the hydrostatic test should be at ambient temperature, but in no case less than 70°F. The appropriate hydrostatic test pressure can then be applied. The test should be conducted in one of several methods:

1. The boiler should be filled slowly at the proper water temperature, venting air through the boiler vent valve. When the boiler is full and all of the air has been vented, the boiler vent valve can be closed. Then the pressure can gradually be raised until the maximum hydrostatic test pressure has been reached.
2. The pressure shall be under close control at all times so that the required test pressure is never exceeded. If a hydrostatic test at 1-1/2 times design or maximum working pressure is applied, the pressure cannot be allowed to exceed more than 6 percent above the design or maximum working pressure for power boilers (Section I), or more than 10 psi for heating boilers (Section IV). A heating boiler should be inspected while under the hydrostatic test pressure, and all joints and connections inspected closely for leakage. Close visual inspection for leakage is not required on a power boiler at this time.
3. For power boilers the hydrostatic test pressure may be reduced to the design or maximum allowable working pressure as shown on the manufacturer's data report and maintained at this pressure while the boiler is carefully examined.

After the boiler is found to be tight, the pressure can be released slowly and the boiler drained. Open the vent valve on the boiler during draining. After the boiler is drained, the blind flanges, plugs, caps and gags (if used) should be removed and all the lines, etc., put back into operating condition.

During the hydrostatic test inspection of the boiler, a few so called "weepers" may be observed. If the weeping tubes are just a few in number and the leak is just a drop or two every few minutes, this is not of great concern. Chances are very good the weepers will dry up completely when the boiler is fired. If, however, there are tubes leaking at a rate of more than one or two drops every few minutes, then the leaking tubes should be re-rolled.

If re-rolling of any tubes is required during the initial hydrostatic test inspection, the boiler inspector generally is present to observe the operation during the re-rolling, or for a re-inspection after the re-rolling. All re-rolling of any previously rolled and flared tubes should be done with straight rolls only, no flare.

**Note: Rolling of tubes in a boiler should be done by an experienced**

**boilerperson. If there is not a qualified boiler repairperson in the customer's organization, then either the boiler manufacturer, their authorized representative or a boiler repair shop should be called in to roll the tubes. After the leaking tubes have been re-rolled, it will be necessary to hydro-test the boiler once again, to make sure everything is tight.**

## **EXISTING BOILER INSTALLATIONS**

An external inspection of an existing installation can be made while the boiler is in operation. Close inspection of the external parts of the boiler, its accessories, and connections should be made before taking the boiler off the line and securing. Notes of all conditions that need attention should be made so that proper repairs can be taken care of after the boiler is shut down. When conditions will permit, the shutdown of an existing installation can often be timed to coincide with the annual or semi-annual inspection, at which time the insurance and/or state boiler inspectors and feedwater and boiler water treatment consultant, can be present.

### **WATER SIDE INSPECTION**

The burner flame shall be extinguished and fuel supply lines shut off and locked where feasible. Where oil is used, atomizers or oil gun assemblies should be removed from the burner. Where gas is used, the supply lines shall be blanked off, or shutoff cocks closed and locked. Care must be taken to ensure no fuel or fuel vapors can enter the boiler furnace while the unit is shut down.

Before draining the boiler, it must be determined that the boiler and setting have cooled sufficiently to prevent damage to the boiler or to prevent the baking of deposits that may be present on the heating surface. It is recommended that the boiler be drained while there is sufficient heat present to dry out the water side of the boiler when ventilated by opening manhole and/or handhole covers. However, the temperature of the water removed from the boiler must be below the maximum temperature that the drain system can tolerate.

Before opening the manhole or handhole covers and entering any part of the steam generating portions of the unit, the boiler stop or non-return valve and the header stop valve must be closed and the drain valve or cock (bleed valve) between the two valves opened. All valves should be tagged and preferably padlocked. After draining the boiler the blowdown valves should be closed and padlocked. To prevent someone from being burned by hot steam, care must be taken to ensure no steam can enter the boiler while the unit is open.

The water surfaces of drums and tubes should preferably not be cleaned, unless otherwise agreed, until after the authorized inspector(s) have had the opportunity to observe the conditions. Examination of the boiler water side before cleaning will assist in judging the adequacy of the feedwater and water treatment program in preventing scale formation, corrosion, or excessive accumulation of sludge. Also the feedwater and boiler water treatment consultant should be notified to permit him/her to inspect the water side of the boiler during this period.

Loose deposits should be washed out with a high pressure stream hose. Because of the possibility of tube joint chilling, all wash water should be at ambient temperature, but in no case less than 70° F. It is advisable to disconnect the blowdown piping from the boiler and run the wash water to waste, or to provide strainers in the blowdown openings to prevent foreign matter from lodging in blowdown piping and valves.

Many of the internal waterside surfaces of boilers cannot be cleaned properly by mechanical means. When it becomes necessary to clean these surfaces, chemical cleaning must be employed. Such chemical cleaning can be acidic or basic, depending upon the type of deposits that need to be removed. When chemical cleaning is required, care must be taken to avoid damage to both ferrous and non-ferrous materials through improper use of the solvents. Also, be aware of the potential dangers involved when dealing with corrosive solutions and possible explosive and toxic products of the cleaning process. Work of this kind should be supervised by personnel specially qualified by training and experience in this highly technical field.

It is important to maintain adequate ventilation in the boiler room during any chemical cleaning procedures. Before internal inspections are performed, and after the cleaning process has been completed, the boiler must be properly ventilated. Appropriate lighting as previously described (see Figure 2-1) must be used during internal inspections.

Careful inspection of the internal areas of the pressure parts should be made to detect any corrosion or cracking of the tube sheets, tube ends, furnaces, or drums, signs of leaking tubes, excessive thinning of the tubes from repeated rolling, and the condition of any ferrules and nipples within drums. Also note any evidence of corrosion or cracking due to leakage at manholes or handholes.

Other points to look for when examining the interior of the boiler include cracks, broken stays, cracked fittings, corrosion, erosion, scale, and thin places in the drums. The upper half of drums in the steam space shall be examined particularly for signs of grease, oil, or similar deposits.

The interior of the tubes or the space between the tubes shall be examined for scale and deposits. In the case of a Firetube boiler, a small light may be lowered between the tubes to make sure there is no restriction to impede boiler circulation. The condition of all drum internals should be observed. Internal feed pipes, dry pans, scrubbers, baffles, chemical feed pipes, surface blowoff and bottom blowdown connections, and other accessories shall be examined to see that their openings and perforations are free from deposits. All interior fittings shall be examined for loose connections and damaged or missing gaskets.

If fusible plugs are used, see that they are kept in good condition and that they are not used for more than one year. The ASME Code states that the fusible plug shall be replaced at least once each year. However, the use of fusible plugs is no longer required by ASME Codes. Usually the best time for replacing a fusible plug is during the time the boiler is down for the annual inspection. A fusible plug is defined as a hollow threaded plug. The hollowed portion is filled with a low melting point material and it is usually located at the lowest permissible water level.

## **FIRESIDE INSPECTION**

Examination of the fireside areas of the unit should include checking the condition of baffles, refractory and metal, setting and poured refractories, gas passes, sootblower lances and support bearings. All brick, tile or refractory walls and door linings should be inspected carefully for spalling or decay of refractory surfaces, cracking and settlement. Any such observed conditions should be cleaned out and repaired. Cracks or holes in walls and baffles will permit short-circuiting of the combustion gases. Such shortcircuiting will eventually cause a burnout and failure of the affected part, and will change the combustion, as well as result in a loss in boiler efficiency. A deteriorated refractory and/or insulation can usually be detected during operation by location of hot spots on the casing or other outer covering of the furnace and boiler, or during a combustion gas analysis.

## **EXTERNAL INSPECTION**

External examination of the boiler should include the visual inspection of the outer surfaces during operation as stated earlier. Other external points that should be inspected and examined include the gauge glasses, water column(s), water level controls, high and low-water alarms and cutoffs, blowoffs, blowdown, feed water valves, check valve, feed line at the entry to the boiler, safety valves, and boiler stop valves or non-return valves.

All piping connecting these various controls and accessories should be checked to make certain there are no deposits to stop or impede proper flow through

the piping and to the controls. Most installed piping for these controls includes cleanout plugs at critical points. The cleanout plugs should be removed and the pipe rodded out to remove any scale, mud or sediment.

The condition of the water column(s), gauge glass and trycocks (if installed) should be carefully observed. Make sure the water pipe connecting the water column drains toward the boiler. The water column should be checked with respect to its proper level in relation to the normal water level in the boiler. In Firetube boilers check the position of the water column gauge glass by leveling across the top row of tubes. Replace or repair any part of this control before restoring the boiler to service.

All connecting piping and all exterior piping supports should be inspected to ensure that no excessive stresses or strains are exerted on the pressure parts of the boiler.

For future reference a written report should be made of all points observed during the inspection. Immediate steps should be taken to correct those items that can be corrected at the completion of the inspection. Careful consideration should be given to those points concerning conditions of the pressure parts, which will require changes in operating procedure or maintenance.

## **NEW OR EXISTING INSTALLATIONS**

### **Burner And Controls**

Before making any attempt to start a burner-boiler unit, the manufacturer's instruction manual should be read thoroughly in order to get a good understanding of how the burner operates. The operator should be familiar with the various parts of the burner and understand their function and operation.

To describe all of the different types of fuel burning equipment is beyond the scope or intent of the guide. The guide covers points that can, with slight variations, be applicable to many types of equipment.

The burner should be checked over thoroughly to ascertain all parts are in proper operating condition. Some of the points to check are:

1. Fuel lines: All of the fuel connections, valves, etc., should be inspected thoroughly. Make sure all the joints are tight, pressure gauges and thermometers are in place and tight, and valves are operative. Fuel lines should be checked for leakage.
2. Check all of the burner linkage for tightness and wear at connecting points. If possible to do so, check linkage for travel and proper movement.
3. The electrical wiring should be checked very carefully. Make sure all connections are tight. Check all the terminal strip connections. Sometimes

the vibration from shipping or operation will loosen them. Plug-in controls, relays, timers, switches, etc., should all be checked to ensure the wires are tight. Check rotation of fan, pumps, and air compressor motors, etc.

All of the various interlocks, limits and safety controls should be checked to ensure that they are operational and set at the proper safe set point. An actual operating test of the controls cannot be made until the burner is in operation.

All or most all of the following limits may be found on the average package boiler/burner, depending on the insurance regulations, federal, state or local codes being complied with.

### **Operating Limits & Interlocks**

1. High Limit Pressure Control
2. High Limit Temperature Control (Hot Water)
3. Operating Limit Pressure Control (Steam)
4. Operating Limit Temperature Control (Hot Water)
5. Modulation Pressure Control (Steam)
6. Modulation Temperature Control (Hot Water)
7. Low Water Cutoff/Auxiliary Low Water Cutoff
8. Flame Failure (Part of Flame Safeguard Function)
9. Combustion Air Proving Switch
10. Atomizing Media Proving Switch, for Oil Burner only (Steam and/or Air)
11. Low Oil Temperature Switch
12. Low Oil Pressure Switch
13. High Oil Pressure Switch
14. Low Gas Pressure Switch
15. High Gas Pressure Switch
16. Low Fire Switch
17. High Fire Switch

There are other operating limit interlocks that can be added to the control system, depending on the degree of sophistication.

### **Auxiliary Equipment**

All of the boiler room accessory or auxiliary equipment should be inspected thoroughly to ensure everything is in good working order and ready for operation.

## **Economizers**

Manufacturer's drawings and instructions should be followed when making an inspection of the economizer. Check for proper installation, check breeching duct work, arrangement, alignment and expansion provisions. Tubes and headers should be checked to make sure there is no plugging nor obstructions on both the waterside and fireside of the tubes. Check feedwater piping to the economizer inlet header and the piping between economizer and boiler. Shutoff and check valves, isolating valves, feedwater control valve and relief valves, etc., test connections, thermometers and pressure gauges should all be inspected and checked for proper safe settings and operation.

## **Pumps**

Boiler feed pumps, transfer pumps, condensate pumps - all of the pumps in the system-should be inspected. Piping connections to the pump suction and discharge ports should be checked. Adequate provisions should be made for proper expansion to prevent undue strains imposed on the pump casing. Drain lines, gland seal lines, recirculation lines, etc., should all be checked to determine if they are in accordance with the manufacturer's recommendations. The coupling alignment should be checked to ensure no misalignment exists. If the coupling alignment is not up to the pump or the coupling manufacturer's recommendations, they must be realigned so they are within the manufacturer's recommended tolerances. After all of the above precautions have been carried out, check the pump for proper rotation. The appropriate pump motor starter can be momentarily energized for this operation. Be careful not to hold the starter in too long.

**Note: Care should be exercised when checking for proper rotation.**

**Some pumps may be seriously damaged if the pump is rotated in the wrong direction. Where the possibility of damage to the pump does exist (refer to the manufacturer's instruction manuals), it is advisable to disconnect the coupling before checking the motor rotation. The coupling can then be reconnected and aligned after it has been determined the motor rotation is correct.**

## **Blowdown Heat Recovery**

The continuous blowdown heat recovery, flash tank heat exchanger and blowdown separator piping, both drain and vent, should be inspected for leaks, proper slope of drain lines, and proper valve operation. All controls and automatic valves should be checked for proper safe settings and operation. The tanks should be inspected to ensure no sediment is blocking top outlet and/or drain lines.

## **Sample Cooler**

Ensure there are no leaks in the sample-in and sample-out lines or in the cooling water in and out lines. Check to ensure none of the lines are plugged.

## **Deaerator/Surge Tank/Packaged Feed Systems**

Installation of this equipment should conform to manufacturer's recommendations. Check all piping for proper connections. Check valves and controls to be sure they are installed properly and set to proper operating parameters.

Check internals of the tank(s) and remove any foreign material. The inside of the tank should be wiped thoroughly to remove any oil or grease from manufacturing. Make sure all pipe connections leading into and out of the tank are clear. Vent valves, overflow drainer and relief valves, etc., should be piped to a point of safe discharge.

There is a possibility that some installations may have problems with corrosion in their tanks. If such problems occur, the insurance and/or state boiler inspector should inspect the tank. There are brushed-on or baked-on coatings available to prevent tank corrosion. Corrosion of the tank(s) may be a sign of system or mechanical problems.

## **Filters**

The filter inlet and outlet piping and drain lines should all be checked against installation drawings and for tightness. All electrical wiring should be checked for tightness at connecting points. Ensure all filter beds are clear of contamination. Inspect tanks to ensure that if a lining was installed, it is still in place. All automatic, pneumatic or pilot operated valves, water meters, or pressure differential switches, etc., should be inspected, set at proper set point and tested for operation.

## **Water Softener/Dealkalizer/Reverse Osmosis**

All inlet and outlet piping and drain lines should be checked against installation drawings and for tightness. All electrical wiring should be checked for tightness at connecting points.

Depending on the particular system being used, the tanks should be charged with the required filtering or exchange media and chemical solutions.

All automatic, pneumatic or pilot operated valves should be inspected, set at proper set point and tested for operation.

## **Chemical Feeders**

There are several different methods of feeding chemicals into a boiler. There are two basic types, however, and most chemical feed equipment can be classed in one or the other of these groups.

First and simplest of the systems is the pot type shot feeder. Pot type feeders are frequently installed in small boiler plants on the suction side of the boiler feed pumps. The feeders are convenient and economical for the injection of the precipitating chemicals, such as phosphates, caustic soda and soda ash to boilers.

Such chemicals as sodium sulfite (for oxygen removal), caustic soda or soda ash (for pH adjustment) or any of the surface active organic and inorganic chemicals (for prevention of deposits in distribution lines) should not be fed through this type of feeder.

The second group of chemical feeders involves the pump type of feeder, which provides for feeding chemicals into a boiler at a predetermined and controlled rate. Depending upon the degree of sophistication, this type of system usually includes a chemical tank, pump, complement of valves, piping, etc., plus some type of control mechanism (timer or metering).

This equipment can be purchased as a packaged unit ready for installation. When the equipment is purchased as separate items, they have to be mounted, piped and checked out for proper operation. The most important part of checking out this equipment is to examine them for leaks, proper installation, pump rotation and operating controls.

## **Economizers**

On large industrial or utility boilers, the economizer is normally an integral part of the boiler. For smaller boilers, packaged heat recovery equipment is external.

Economizers are normally bent tube exchangers. The boiler feedwater flows through the tubes on its way to the boiler. The tube bank is assembled into a section of duct work which is located in the breeching between the flue gas vent connection on the boiler and the stack or chimney. The products of combustion leaving the boiler flow through this duct, over the tube bank, giving up its heat to the boiler feedwater.

Manufacturer's drawings and instructions should be followed when making inspection of the economizer. When inspecting an economizer, check for proper installation, check breeching duct work, arrangement, alignment and expansion provisions. Make sure all internal baffling, tube arrangements, headers, tube sheets, etc., are installed in accordance with manufacturer's

recommendations. Tubes and headers should be checked to make sure there is no plugging nor obstructions. Check feed piping to the economizer inlet header and piping between the economizer and the boiler. Check and inspect shutoff and check valves, isolating valves and relief valves, test connections, thermometers and pressure gauges.

# CHAPTER 3

## ORIGINAL STARTUP

### INITIAL STARTUP FOR A NEW BOILER

After the initial inspection is completed, the new boiler is ready for startup. Startup can be the most critical period in the life of the boiler. The manufacturer's installation and/or operating instruction manuals should be referred to, and their contents thoroughly understood by all parties involved in the initial startup and eventual operation of the boiler(s). The personnel responsible for operating and maintaining the boiler should be present during the initial startup period.

**Note: No attempt should be made to initially fire the boiler until the following points have been checked:**

1. A sufficient water supply is available. Water used to initially fill the boiler must be at ambient temperature, but not less than 70°F. Water used during the boil out period should be at the normal temperature of the water coming from the deaerator or packaged feedwater system.
2. Steam piping, blowoff and blowdown lines, etc. must be inspected and ready for operation. All piping must be inspected for adequate support and expansion provisions.
3. All fuel supply lines must be checked for tightness and leaks. Strainers are most important to the safe operation of gas and/or oil fired units.
4. Electrical power lines to the boiler/burner unit are connected and the voltage required is verified. (Checking out of the burner and controls is covered in Chapter 2.)
5. Hydrostatic test has been completed.
6. Any walkways, platforms, stairs, and/or ladders, etc., that are needed to permit proper access to the boiler/burner, are installed and ready for use.

It is recommended that a newly installed boiler be boiled out. Its internal surfaces could be fouled with oil, grease, and/or other protective coatings from the manufacturing of the boiler. Boiling out will also remove any remaining mill scale, rust, welding flux, or other foreign matter normally associated with manufacturing or shipment. All contamination needs to be removed since it lowers the heat transfer rate, and could cause localized overheating.

Existing boilers that have had any tube replacement, re-rolling or other extensive repairs to the pressure parts should also be boiled out. The lubricant used for rolling tubes, plus the protective coating on the new tubes, must be removed by boiling out before the repaired boiler can be put back on the line.

There are several methods used to perform the boilout operation. The boilout chemicals that are added to the water create a highly caustic solution, which upon heating dissolves the oils and greases and takes them into solution. After the period of boil out and blowing down the boiler, the concentration is diluted enough that practically all of the oils and greases and other matter have been eliminated.

Since the guide covers firetube and watertube boilers, we will divide the boilout instructions into two (2) parts, one for firetube and one for watertube. The procedures have been recommended by Cleaver-Brooks for many years.

**Note: No chemicals should be added to the boiler until the hydrostatic test has been completed and the burner has been checked to ensure a low fire flame can be established.**

## **FIRETUBE BOILER BOILOUT**

The suggested procedure for boiling out new units prior to initial firing is as follows. Water relief valves and steam safety valves must be removed before adding the boilout solution so that neither it nor the grease which it may carry will contaminate the valves.

All valves in the piping leading to or from the system must be closed to prevent cleaning solution from getting into the system.

Soda ash and caustic soda are the suggested chemicals for cleaning of boilers. The quantities will vary according to conditions, but an amount from 3 to 5 pounds of each chemical per 125 gallons of water is suggested. A small amount of laundry detergent should be added to this solution to serve as a wetting agent. Refer to manufacturer's information data report for the water capacity of the boiler.

When dissolving chemicals, the following procedure is suggested. Warm water should be put into a suitable container. Slowly introduce the dry chemical into the water, stirring it at all times until the chemical is completely dissolved.

Add the chemical slowly and in small amounts to prevent excessive heat and turbulence.

**Note: Use of a suitable face mask, goggles, rubber gloves, and protective garments is strongly recommended when handling or mixing caustic chemicals. Do not permit the dry material or the concentrated solution to come in contact with skin or clothing.**

Fill the pressure vessel with clean water until the top of the tubes are covered. Add the cleaning solution and then fill the boiler to the top. An overflow pipe should be attached to one of the top boiler openings and routed to a safe point of discharge. Water relief or safety valve tapings are usually used.

The boiler should then be fired intermittently at low fire rate, sufficient to hold solution just at the boiling point. During this slow firing, a small amount of fresh water should be periodically introduced into the pressure vessel to create an overflow that will carry off surface impurities. Ensure this overflow is discharged to a safe point of discharge as determined by federal, state, or local codes.

The boilout operation should be carried out for 6 to 8 hours minimum and then the boiler should be permitted to cool.

When the temperature of the water in the boiler has fallen to 120° F or less, the boiler should be drained.

Remove handhole and manhole plates and rinse or flush internal waterside surfaces until they are clean and free of deposits, using a high-pressure water hose. The water temperature should be ambient, but not less than 70°F.

After the boilout procedure has been completed, consideration must be given to the possibility that contaminated materials could enter the boiler from the system. Refer to Chapter 4 of the guide and follow the procedures given there regarding feedwater treatment.

### **Washing Out Pressure Vessel (Steam)**

No later than three months after initially placing the boiler into operation and thereafter as conditions warrant, the pressure vessel should be drained, handhole and manhole covers removed, and the internal waterside surfaces inspected for corrosion, pitting or formation of deposits. Upon completion of the inspection, the pressure vessel interior should be flushed out, as required, with a high-pressure hose.

The water temperature should be ambient, but not less than 70°F. If deposits are not fully removed by flushing, an immediate consultation with your water consultant or feedwater treatment company may be needed. In extreme cases, it may be necessary to resort to acid cleaning. Should acid cleaning be required, professional advice is recommended.

Inspections will indicate the effectiveness of the feedwater treatment program. Water conditions and the amount of make-up water required are also factors to be considered in establishing frequency of future pressure vessel washout periods. At later washouts, the condition of the waterside surfaces will indicate the effectiveness of the water treating program, as well as the suitability of the intervals between washouts. A feedwater consultant or a water treatment service should include periodic pressure vessel inspection and water re-analysis.

### **Washing Out Pressure Vessel (Hot Water)**

In theory, a hot water system and boiler that have been initially cleaned and filled with raw water will require no further cleaning or treatment. However, the system (new or old) could allow the entrance of air and the unintended introduction of raw makeup water that can lead to pitting, corrosion, and formation of sludge, sediment or scale on the pressure vessel.

Therefore the pressure vessel waterside should be inspected no later than three months after initially placing the boiler in operation, and periodically thereafter, as indicated by conditions observed during inspections. At inspection time, the pressure vessel should be drained, handhole and manhole covers removed, and internal waterside surfaces inspected for corrosion, pitting or formation of deposits. Upon completion of the inspection, the pressure vessel interior should be flushed out as required with a high-pressure hose. The water temperature should be ambient, but not less than 70°F. If deposits are not fully removed by such flushing, immediate consultation with your water consultant or feedwater treatment company may be required. In extreme cases, it may be necessary to resort to acid cleaning. Should acid cleaning be required, professional advice is recommended.

Inspections will indicate the effectiveness of the feedwater treatment program, water conditions and the amount of make-up water required are also factors to be considered in establishing frequency of future pressure vessel washout periods. At later washouts, the condition of the waterside surfaces will indicate the effectiveness of the water treating program as well as the suitability of the intervals between washouts. A feedwater consultant or a water treatment service should include periodic pressure vessel inspection and water re-analysis.

There is a tendency to mistakenly assume that a hot water system is without leakage because of the difficulty of measuring the actual quantity of makeup water added to the system during operation. Since raw makeup water requires treatment in the same manner as water used for complete filling, a water meter, capable of accurately recording low rates of flow, is recommended

for installation in the makeup water line to the system or boiler. A meter will provide guidance in determining the amount of raw water admitted and the additional water treatment required.

## **WATERTUBE BOILOUT**

### **Steam And Hot Water Boilers**

It is suggested that temporary gauge glasses be installed during the boiling out operation and that rubber gaskets be used with a temporary round glass. A prismatic gauge glass, if supplied, should be removed, and a temporary round gauge glass should be substituted.

Wipe out as much excess oil as possible from the drums with clean rags. Clean out any loose debris from the drums.

Internal drum fittings, feed distributing pipes, deflector baffles, etc., if not already fastened in place, should be placed in the drum during the cleaning process. Any of the fittings or pieces that are loose should be hung in position or securely placed in the steam drum during the boiling out period in such a manner that no tube ends are obstructed.

Soda ash and caustic soda are the suggested chemicals for cleaning of boilers. The quantities will vary according to conditions, but an amount from 3 to 5 pounds of each chemical per 125 gallons of water is suggested. A small amount of laundry detergent should be added to this solution to serve as a wetting agent. Refer to the manufacturer's information data report for the water capacity of the boiler.

When dissolving chemicals, the following procedure is suggested. Warm water should be put into a suitable container. Slowly introduce the dry chemical into the water, stirring at all times until the chemical is completely dissolved. Add the chemical slowly and in small amounts to prevent excessive heat and turbulence.

**Note: Use of a suitable face mask, goggles, rubber gloves, and protective garments is strongly recommended when handling or mixing caustic chemicals. Do not permit the dry material or the concentrated solution to come in contact with skin or clothing.**

Fill the boiler with water at ambient temperature but not less than 70°F, to a point just below the manway opening in the upper drum. Add the chemicals in solution through the manway, or through the upper drum vent valve, or through the chemical feed line. Close and secure the manway cover.

Fill the boiler with water to 1" to 1/2" below the top of the gauge glass. The

normal operating level is at about the center of the gauge glass. Exercise caution to prevent water from spilling over into the superheater, if the boiler is so equipped.

Open the steam drum vent valve. If the boiler is equipped with a superheater, open the superheater drain and vent valves. Recheck the feedwater supply, gauge glass, pressure gauge, and position of all valves.

Start the burner and allow the boiler to warm up slowly. When steam vapor is noticed at the boiler vent, close the vent valve. The superheater inlet drain valve (if provided) should be closed, but the superheater outlet drain valve should be left open enough to permit continuous cooling of the superheater tubes. Allow the boiler pressure to increase at a rate not to exceed 50 psi per hour until the pressure has reached half of the normal operating pressure-not less than 80 psi but not to exceed 150 psi. Cycle the burner at low fire to maintain the pressure for approximately six (6) hours.

During the pressure raising and boiling out period, keep the water above the bottom of the gauge glass by adding water as required.

At the completion of the boilout period, shut the burner off. Add water slowly until the gauge glass shows full. Blow down through the continuous blowdown line in the steam drum, until the water falls to approximately the center of the gauge glass. From this point, blow off with the bottom blowoff valves until the water level falls to within approximately 2" of the bottom of the gauge glass. The water column and gauge glass should also be blown down.

After each blow, refill the boiler to 1" to 1/2" below the top of the gauge glass and allow the boiler to soak and boil for about 15 minutes before the next blow cycle. Repeat the cycle of blowdown operation for a minimum of six times or until a cooled sample of the boiler water shows no oil. If possible, maintain the chemical concentration during the blowdown by using a chemical feed pump.

Pressure should lower somewhat during the blowing and refill cycles. However, to ensure boiler water side circulation, the pressure should not be allowed to fall below 50 psi.

After it has been determined that the water in the boiler contains no oil, shut off the burner and allow the boiler to cool. When the temperature of the water in the boiler has fallen to 120°F or less, the boiler should be drained.

Open the manways and inspect the drums. Wipe out any sludge or scum that might be present. Then wash out the boiler with a high pressure hose using water of ambient temperature, but not less than 70°F. Use a hose on each individual tube, including superheater, if provided. If possible, the washing should be done from the bottom of the tube. The fireside of the boiler should be checked for any unusual conditions.

Upon completion of the wash down, inspect the internal surfaces and, if not clean, repeat the boilout.

Replace manhole covers, using new gaskets. Replace the gauge glass if necessary and/or reinstall the prismatic gauge glass if the boiler is so equipped. Refill the boiler with clean treated water. If not immediately being placed into service, fire the boiler until it is heated to at least 180°F to drive off any dissolved gases, which might otherwise cause corrosion on the waterside surfaces of the boiler.

## **FIRING UP**

Firing the burner should follow the procedure(s) outlined in the specific burner operating instruction manual for the equipment being started. Check the condition of all auxiliary equipment that serves in firing or feeding the boiler, interlocks, limits, feedwater supply pumps, etc. By this time all of the auxiliary equipment should have been checked out for proper size and pressure to ensure proper operation of the unit.

1. When the boiler is closed, check and close the blowoff valves, water column and gauge glass drains, and gauge cocks, if mounted on the water column.
2. Open the vent valves, gauge glass shutoff valves and steam pressure gauge valves.
3. Fill the boiler with water at ambient temperature, but not less than 70°F. Fill to a level about 2" above the bottom of the gauge glass or sufficient to close the low water cutoff contact in the burner circuit. Be careful to fill slowly and vent fully to prevent any pressure buildup from flashing of warm water.
4. Blow down the water column(s) and the gauge glass(es), making sure that water returns to proper level promptly. The gauge cocks should be opened to verify the water level, if they are mounted on water column.
5. Fuel piping, whether gas or oil, should have been pretested for leaks. The oil pump sets should be started so oil can be circulating, and oil pressures adjusted to the burner requirements. If the fuel is gas, check the gas pressure and adjust the boiler gas pressure regulator for proper pressure. If air has not been bled from the gas line, it should be done at this time.

**Note: The gas utility company should be involved in the above operation so they can supervise the bleeding and cleaning of the gas line. In new installations, where the fuel lines (gas and oil) are new, precautions should be taken to make sure these lines are clean. Dirt, sand, gravel,**

thread cuttings, steel chips, welding beads, welding rod, rags and wood chips, etc., can all find their way into shutoff valve seats, control valves, pressure regulators, burner nozzles, etc. Such debris caught in the wrong place can cause very serious problems. Proper strainers should be installed in the fuel lines to remove all of the aforementioned debris. The strainers should be checked frequently, especially during the first few days of operation. When there is much foreign material in the fuel lines, the strainers will quickly clog and impede proper flow of the fuel to the burner.

6. Start the burner on low fire in accordance with instructions listed in the specific burner operating instruction manual.
7. The boiler should be warmed up slowly to permit temperatures to reach saturation temperatures, and metal and refractory temperatures to equalize. As the boiler begins to warm up, it should be watched closely for leaks and also signs of expansion. If the boiler has been sitting outdoors or in a damp atmosphere, there is a good possibility that the insulation has absorbed some moisture. Moisture will generally show up as condensate or steam vapor leaking out of some of the casing joints or sealing plates. The points should be observed and should dry up after a reasonable period of time.
8. When pressure in the boiler has reached 10 to 15 psi, close the drum vent. Open the drains in the steam headers, if supplied, and warm them up. If a superheater is provided, leave the superheater startup vent open until the boiler stop valve is open and steam flow through the header is sufficient to keep the superheater tubes cool.

## **BOILER CONTROLS**

Before the boiler is permitted to go on the line, all of the safety controls should be checked to make sure they are all operating properly.

To meet the codes of regulatory bodies, i.e., UL, Insurance companies, federal, state, local codes, etc., some or all of the following controls may be found on a boiler.

### **Flame Safeguard**

The purpose of the flame safeguard control is to monitor the burner start up sequence, the main flame and control the firing rate during normal operation. The flame safeguard also controls the shut down sequence.

Following is a brief step-by-step description of the operation of a typical flame safeguard/programming control utilizing a gas pilot for ignition.

On automatic burners, this programming control establishes the operating sequences by enforcing a fixed, preassigned time schedule for each phase of burner operation. The usual sequence is as follows:

1. The burner switch is turned on or the operating limit pressure (or temperature) control closes. If all required limit controls are satisfied, the blower motor starts and the automatic sequence begins.
2. The programmer actuates the modulating motor and drives it to high fire position and purges the boiler for a predetermined period of time. No fuel is introduced at this time because the fuel valves remain closed.
3. After the prepurge cycle is completed, the programmer drives the modulating motor and burner linkage back to low fire position.
4. The ignition transformer is energized and the pilot solenoid valves are opened. The pilot must light.
5. Trial for ignition period: If the pilot has ignited and the flame is proven, the programmer moves on to the next step. If the pilot flame is not proven during this trial for ignition period, the programmer will close the pilot solenoid valve, turn off the ignition transformer, lock itself out and sound the alarm horn (if equipped).
6. If the pilot flame is proven, the programmer, after a timed interval, energizes the main flame fuel valve(s) and trial for main flame is started, at minimum fuel rate.
7. After a timed period, the main flame has to be established. If this is completed, the programmer extinguishes the pilot and then continues to monitor the main flame.
8. The programmer continues to monitor the main flame while the burner continues to automatically modulate (if the burner is capable of full modulation) on an increasing or decreasing firing rate to satisfy the load demand.
9. If the operating limit pressure (or temperature) control opens the circuit because of a rising steam pressure (or temperature), the programmer closes the fuel valves and allows the blower to postpurge the furnace and then shuts the blower off.
10. The programmer cycles to off position and is now ready for restart upon demand.

## **Gas Pilot Flame Adjustment**

This is an adjustment to set the size of the pilot flame so the pilot is large enough to ignite the main flame and also be detected by the flame sensor. Minimum pilot tests should be conducted in accordance with flame safeguard/programming control manufacturer's recommendations.

## **High Limit Control**

This pressure (or temperature limiting control) is set above the operating limit control and, in the event the pressure (or temperature) in the boiler rises above the normal operating limit, the control reenergizes the limit circuit to shut down burner operation. The control is equipped with a manual reset feature that has to be reset before the burner can be restarted.

Any time that one or more of the safety or high limit controls is actuated to shut down the burner, it must be determined why the fault occurred, before an attempt is made to restart the burner.

## **Operating Limit Control**

On a rise of boiler pressure (or temperature) above the desired operating pressure (or temperature) setting, the control deenergizes the limit circuit to shut down burner operation. It is adjusted to make and break the circuit at preselected points. With a drop in pressure (or temperature), the control will make the limit circuit and start the burner through an automatic restart cycle.

## **Modulating Control**

The control causes the modulating motor to change the firing rate to meet the demands of a varying load, on full modulation burners.

## **Atomizing Media Pressure Switch**

When an oil burner uses air or steam to atomize the oil, means must be taken to assure the atomizing medium is present at the required pressure. In the event of low atomizing air or steam pressure, the control will open a circuit and shut down the burner.

## **Low Fire Hold Control**

The purpose of the control is to limit the burner to low fire position until the pressure (or temperature) in the boiler is high enough that the boiler has had sufficient time to warm up. After the burner has operated in the low fire position long enough to allow the boiler to warm up, the control will close and release the burner firing rate control to the modulating control.

## **Low Water Cutoff**

The control is generally a float operated or probe operated control that is set to deenergize the burner limit circuit and shut down the burner upon detecting a low water condition in the boiler.

On a low pressure steam boiler, the Low Water Cut Off is positioned to allow 0 to 1/4" of water above the upper most tubes in a firetube when the gauge glass shows the Low Water Cut Off point. On a high pressure unit, there must be a minimum of 3" of water above the upper-most tubes with zero in the gauge glass.

The float type of control actuates a switch, or several switches, to perform one or more functions. The first function of the low water cutoff is to deenergize the burner limit circuit and shut down the burner, if the water level in the boiler drops below the safe operating level. Another function of the control is to sound the low water alarm at the same time the burner is shut down. A pump on-off control can start and stop the boiler feed pump to maintain water at safe operating level in boiler. One additional function that may be added to the control is a high water alarm, sound an alarm when the water level in the boiler exceeds a predetermined level.

A probe type of control performs the same functions as the float control, except the probe depends on the conductivity of the water to complete the desired circuits. Metal probes of varying length are suspended in a sleeve or chamber and a low current utilizes the conductivity of the boiler water to complete a circuit and energize a control relay. When the water level in the boiler drops down below the end of the probe (electrode) the circuit is deenergized and the control relay is de-energized, or energized in the case of high water. In this type of control, there are no moving parts within the probe chamber.

## Auxiliary Low Water Cutoff

Just as its name implies, this control is an auxiliary (additional, supplementary) control, designed and wired in series with the primary low water cutoff. Generally it is located in such a manner that it deenergizes the limit circuit at a level slightly below the primary low water cutoff.

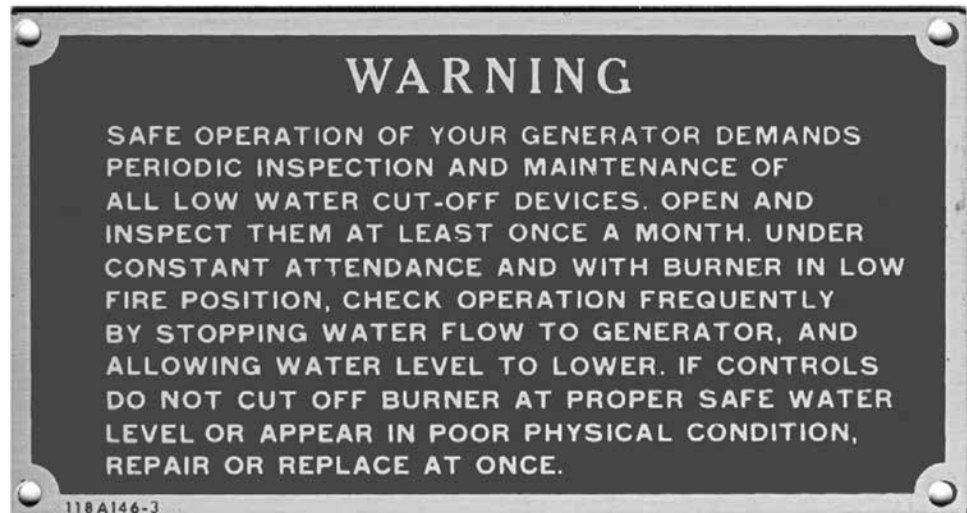

*Figure 1-28: Low Water Cut-Off Information Plate*

The purpose of such an auxiliary control is to act as a backup safety control in the event the primary low-water cutoff fails to shut off the burner, in the event of a low water condition.

Figure 3-1 is a replica of the low water cutoff plate attached to a steam boiler. The instructions contained in it should be followed on a definite planned schedule. These controls normally function for long periods of time which may lead to laxity in testing on the assumption that normal operation will continue indefinitely.

The following three (3) paragraphs are taken from Engineering Bulletin No. 70 “Boiler Log Program” published by the Hartford Steam Boiler Inspection and Insurance Company. The statistics shown here prove how important it is to properly maintain and test the boiler safety controls.

*“Not every accident is preventable. The results of accident investigations show, however, that by far the great majority of accidents to boilers are preventable. The number of such accidents can be effectively reduced through the proper application of operating and maintenance logs.*

*Among the more common preventable accidents are those involving overheating of a boiler. Most of these occurrences are due to low water conditions. As shown by statistics developed by Hartford Steam Boiler on accidents occurring in a recent one year period, 89 percent of the accidents*

*to low-pressure Firetube heating boilers, 59 percent of accidents to high-pressure Firetube power boilers, and 42 percent of accidents to all watertube boilers involved overheating or burning.*

*Of the foregoing accidents, the failure of operating or protective controls to function properly accounted for 52 percent of the accidents to low-pressure Firetube heating boilers; 46 percent of the accidents to high-pressure Firetube power boilers; and 16 percent of the accidents to watertube boilers.”*

The need to regularly check water level controls and the waterside of the pressure vessel cannot be overemphasized. Most instances of major boiler damages are the result of operating with low water or the use of untreated or incorrectly treated feedwater.

### **Low Gas Pressure Switch**

On gas fired boilers, the control is normally closed whenever gas line pressure is above a preselected pressure. The Low Gas Pressure Switch opens when the gas pressure drops below a preselected minimum requirement and deenergizes the main gas valve(s) and energizes the vent valve.

### **High Gas Pressure Switch**

Normally closed whenever gas line pressure is below a preselected pressure; opens when gas pressure rises above a preselected maximum requirement and deenergizes the main gas valve(s) and energizes the vent valve.

The above two switches are non-recycling and have to be manually reset after a safety shutdown due to high or low gas pressure.

### **Combustion Air Proving Switch**

This is an air pressure actuated switch. The contacts close on proving of sufficient pressure of combustion air from the forced draft fan.

The control is generally on all boilers in one form or another to prove that the combustion air is available for burning the fuel when it is introduced into the burner.

### **Low Oil Temperature Switch**

When heavy oil is being burned, the oil must be heated in order to atomize properly. The control will prevent the burner from starting and will shut the burner down, if the oil temperature drops below the required temperature for proper operation. The control can be wired into several circuits of the flame safeguard/programming control.

## **High Oil Temperature Switch**

The control serves the same function in reverse that the low oil temperature switch does. This switch opens the circuits and shuts down the burner when the oil temperature rises above a preset temperature.

## **Low Oil Pressure Switch**

The control is designed to open the burner limit circuit in the event the oil pressure should drop below the preselected minimum pressure for proper operation. The control may be equipped with manual reset.

## **Bringing Boilers On Line**

After all of the various safety and interlock controls have been checked to make sure they are functioning properly, the boiler stop valve can be opened and the boiler allowed to go on line. When opening the boiler stop valve, it must be done very slowly to permit the steam line to warm up gradually and to equalize the line pressure. If live steam is permitted to pressurize a cold line too fast, it is possible to do considerable damage to the steam line and/ or other equipment, and also personnel.

After the steam line pressure is stabilized and it is possible to start picking up load, the air-fuel input should be slowly increased to the burner. As the firing rate to the burner is increased, the air-fuel ratio should be checked at several points to make sure proper combustion is taking place. Once the air-fuel adjustments have been made through the complete firing range, from low fire to high fire, the burner controls can be put on automatic.

When a burner is equipped with single point positioning controls, it is a matter of making adjustments to the air and fuel linkage and cams to get the best firing condition for each position of the cam. Adjustments to the burner may be necessary to get the best flame pattern, fuel-air mixing, etc.

The more sophisticated control systems, dual positioning, parallel positioning, fully metered, or systems with O<sub>2</sub> (Oxygen Trim Systems) could require a good deal more work to calibrate and adjust.

However, no matter which system is employed, it is highly recommended that a factory trained Representative be called in to make the adjustments and tests to put equipment into operation.

During this period, the operators can also be trained in how to operate the equipment.

Once the boiler and accessory equipment has been put into operation and all of the adjustments and calibrations made, the initial startup is complete and we can move into the phase of "Normal Operation."

# CHAPTER 4

## ROUTINE OPERATION

### **NORMAL OPERATION**

Normal operation of a boiler room and all of its associated equipment can become mundane. Day by day, week in and week out, the same chores are performed over and over again. To achieve trouble-free operation, these chores must be performed with diligence. Safe and reliable operation is dependent, to a large extent, upon the skill and attentiveness of the operator. A skilled operator should:

- Have suitable background training
- Have good knowledge of fundamentals
- Be familiar with the equipment
- Be capable of diligently performing routine tasks

It's also very important that preventative maintenance be performed on an established schedule. The following are recommendations on schedules, as well as additional suggestions to assist in keeping the uptime of a boiler and associated equipment to the highest level.

### **Boiler Room Care**

1. Know your equipment. Information is available from your local authorized Cleaver Brooks Representative and from the manuals and drawings supplied with your equipment and from Cleaver Brooks. Keep this information in a boiler file and train personnel to consult this information first whenever they are in doubt.
2. Maintain complete records. Each individual component should be listed on an index card or computer data base as to model, serial number and date of installation. Get replacement part numbers from your local authorized Cleaver-Brooks Representative.
3. Establish a regular boiler inspection schedule. The schedule should include daily, weekly, monthly, semi-annual and annual inspections or activities.
4. Establish and use boiler log sheets. Log sheets should be tailored to your equipment. Review of log sheets will help in establishing a

planned maintenance program. See additional information later in this chapter.

5. Establish and keep written operating procedures updated. The ideal time to originate the procedures is when the equipment is placed in use. A detailed start-up procedure is essential in standardizing the boiler room routine. Posted procedures constantly remind you of the things to be done and help the inexperienced person to assume their proper roll.
6. Good housekeeping is a must. Housekeeping is the one unalterable truth as to the quality of boiler room maintenance.
7. Keep electrical equipment clean. The most common cause of nuisance electrical control problems is failure to maintain equipment properly.
8. Keep an adequate fresh air supply. Proper combustion and burner operation require adequate air. Filters must be kept clean. In severe winter areas, it may be necessary to heat the room to an acceptable ambient temperature.
9. Keep accurate fuel records. A system of recording fuel consumption can keep you informed of any unusual fuel demands, thus enabling you to spot a problem or a waste before it gets out of hand.
10. SAFETY - SAFETY - SAFETY. When a boiler is taken off line, follow good safety practices such as: disconnect all power supplies and lock switches in the off position. Whenever there is more than one boiler connected to a common header, establish routine procedure of locking the header valve on any unit that is down for cleaning or inspection, close any flue gas outlet dampers, and all pieces of equipment required to isolate the boiler.

### **Basic Record System**

A simple and effective system can be established using 5" x 7" lined file cards or a computer data base, and it should contain the following basic information:

1. Boiler and auxiliary equipment nameplate data. Include information such as model number, serial number, fuel series, design pressure and all other related data. Also maintain data on each major component. Keeping accurate data will assist in establishing a record to determine if you carry a required spare part in your inventory, if the part is stocked by your local authorized Cleaver Brooks representative, if the part is stocked by Cleaver Brooks or if it has a long lead time.
2. The name, title, address and phone and fax numbers for your authorized Cleaver Brooks representative, your insurance inspector, state boiler inspector, water treatment company and anyone else that you would

have to contact in an emergency.

In addition to the basic record card, a file should be established to contain information such as:

1. Manufacturer's data report
2. Start-up reports
3. Operating manuals
4. Parts lists and part numbers
5. Fuel supplier
6. Copy of all pertinent correspondence
7. Operating log book
8. Operating procedures

**Table 1: Recommended Boiler Inspection Schedule (Steam and Hot Water)**

Daily *	Weekly	Monthly	Semi-Annually	Annually
Check water level	Check for tight closing of fuel valves	Inspect burner	Clean low water cutoff(s)	Clean fireside surfaces
Blowdown boiler	Check fuel and air linkage	Analyze combustion	Check oil preheater	Clean breeching
Blowdown water column	Check indicating lights and alarms	Check cams	Inspect refractory	Clean waterside surfaces
Check combustion visually	Check operating and limit controls	Inspect for flue gas leaks	Clean oil pump strainer and filter	Check oil storage tanks
Treat water according to the established program	Check safety and interlock controls	Inspect for hot spots	Clean air cleaner and air/oil separator	Check fluid levels on hydraulic valves
Record boiler operating pressure/temperature.	Check low water cutoff(s) operation	Review boiler blowdown procedures	Check pump coupling alignment	Check gauge glass
Record feedwater pressure/ temperature	Check for leaks, noise, vibration, unusual conditions, etc.	Check combustion air supply	Reset combustion	Remove and recondition safety valves
Record flue gas temperature	Check operation of all motors	Check all filter elements	Inspect mercury switches	Check oil pumps
Record oil pressure and temperature	Check general burner operation	Check fuel systems		Check boiler feed pumps
Record gas pressure	Check lubricating oil levels	Check belt drives		Check condensate receivers
Record atomizing pressure	Check flame scanner assembly	Check lubrication requirements		Check chemical feed systems
Check general boiler/ burner operation	Check packing glands			Tighten all electrical terminals
Record boiler water supply and return temperature	Check gauge glass			Check deaerator/ boiler feed system
Record makeup water usage				Check Linkages
Check operation of auxiliary equipment				

\* Daily items may be done more than once per day.

### Daily Maintenance

1. Check water level. An unstable water level can indicate several problems such as excessive solids or water treatment, contamination from oil, overload or control malfunction. Ensure there is water in the gauge glass every time you enter the boiler room. See additional information later in this chapter.
2. Blow down boiler. Blow down the boiler in accordance with the recommendation of your feedwater consultant. A water quality and chemical treatment program will dictate frequency of boiler blowdown. See additional information later in this chapter.

3. Blow down the water level controls to purge the float bowl of possible sediment accumulation. Operating conditions will dictate frequency of this check. See information later in this chapter.
4. Check combustion visually. Look at the flame to see if something has changed. Changes may be an indication that a problem is developing.
5. Treat water according to the established program. Add chemicals and take tests as outlined by your chemical feedwater consultant. See information later in this chapter.
6. Record boiler operating pressure or temperature. An excessive steam or water temperature drop will alert you to excessive loading on the boiler.
7. Record feedwater pressure and temperature. A change in pressure or temperature may indicate a problem is developing with your feed pump(s), deaerator or packaged feed system.
8. Record stack temperature. Changes in stack temperatures could indicate the boiler is sooting, scaling or there is a problem with baffles or refractory.
9. Record oil pressure and temperature. Changes in pressure and/or temperature could have an effect on combustion in the boiler and could indicate a problem in the oil regulators or oil heater.
10. Record oil atomizing pressure. Changes in pressure could have an effect on combustion in the boiler.
11. Record gas pressure. Changes in pressure could have an effect on combustion in the boiler and indicate a problem in the gas delivery system.
12. Check general boiler/burner operation. Maintaining top efficiency is the simple and basic reason for having operating personnel. Is anything different than it was the day before? If so, why?
13. Record boiler water supply and return temperatures. On hot water boilers, record these temperatures to assist in detecting system changes.
14. Record makeup water usage. Excessive makeup water could be an indication of system problems in both steam and hot water systems.
15. Check auxiliary equipment. There is a vast difference between “is it running” and “is it running properly.” Take nothing for granted, as auxiliary equipment can shut down your operation.

### **Weekly Maintenance**

1. Check for tight closing of fuel valves. Check to ensure fuel does not flow

through the fuel valve(s) when the burner is shut off.

2. Check fuel and air linkages. Check to ensure that all set screws on linkages are tight and are securely holding the linkage in place.
3. Check indicating lights and alarms. Check for burned out or loose light bulbs. Also check to ensure the alarm bell or horn sound on the appropriate shut down condition.
4. Check operating and limit controls. Check to ensure these controls shut the burner down at their predetermined set point. Settings should be verified by checking actual pressures and temperatures on the boiler gauges.
5. Check safety and interlock controls. Check to ensure these controls shut the burner down at their predetermined set point. Settings should be verified by checking actual pressures and temperatures on the boiler gauges.
6. Check operation of water level controls. Stop the boiler feed pump and allow the control to stop the boiler under normal low fire conditions. See your operating manual for a more detailed procedure. See information later in this chapter.
7. Check for leaks, noise, vibration, unusual conditions, etc. Checking for these items is a cost effective way to detect system operational changes. Small problems can be corrected before they become large problems.
8. Check operation of all motors. By developing a routine, any change in operation or bearing temperature will usually be caught in time to avoid a failure.
9. Check lubricating levels. Check levels of any oil bath filters, oil level in air/oil tank, oilers on pumps, etc. Add oil in accordance with the manufacturer's recommendations.
10. Check the flame scanner assembly. Using the appropriate meter, check the flame signal strength at the program relay flame amplifier. Ensure the scanner assembly is clean and dry.
11. Check packing glands on all pumps and metering devices. Proper tension on packing glands will extend life of the equipment.
12. Check gauge glass. Ensure there are no cracks or etching in the glass or leakage around the packing.

### **Monthly Maintenance**

1. Inspect burner operation. Do a visual inspection of the pilot flame, main

burner flame throughout the firing range, free movement of linkages and general burner operation.

2. Analyze combustion. Take the flue gas analysis over the entire firing range, comparing the combustion analysis and stack temperature readings with previous month.
3. Check cams. Inspect the cam springs for scoring, tightness of set screws, free movement, alignment of cam followers and other related parts.
4. Check for flue gas leaks. Ensure something hasn't changed in the breeching, stack or overall system that allows flue gas to be drawn into the boiler room.
5. Inspect for hot spots. Inspect the boiler to ensure no hot spots are developing on the outside of the boiler. Hot spots can indicate a refractory failure or baffle failure, which could cause improper gas flow through the boiler or the cooling lines could be plugged or disconnected.
6. Review boiler blowdown to determine that a waste of treated water is not occurring. Check water treatment and testing procedures with your feedwater consultant. See additional information later in this chapter.
7. Check all combustion air supply inlets to the boiler room and burner to ensure sufficient air is being supplied.
8. Check all filter elements. Clean or replace as needed. On "self-cleaning" filters, make certain that impurities are flushed or discharged from filter body.
9. Check the fuel system to make certain that strainers, vacuum gauges, pressure gauges and pumps are properly cared for.
10. Check all belt drives for possible failure. Tighten V-belt sheaves and make certain that belts operate with proper tension.
11. Check lubrication requirements of all bearing supported equipment. Do not over-lubricate electric motors.

### **Semi-Annual Maintenance**

1. Clean low water cutoff (s). Remove the head assembly or probes and inspect and clean out any sediment or contamination in the column or piping. Determine why sediment or contamination condition exists. See additional information later in this chapter.
2. Check oil preheaters by removing the heating element and inspect for sludge or scale.

3. Repair refractory. Immediately upon opening the fireside areas, give the refractories an inspection and start repairs as soon as possible. Read and follow refractory repair instructions.
4. Clean oil pump strainer and filter. Ensure they are not plugged, thus reducing the flow of the required oil to the burner.
5. Clean air cleaner and air/oil tank. Inspect and clean out any sediment or contamination. Add oil in accordance with the manufacturer's recommendations.
6. Check pump coupling alignment. Check alignment of all couplings to ensure the tolerances are within the manufacturer's recommendations.
7. Reset Combustion. The entire combustion process should be carefully checked, O<sub>2</sub> readings taken and necessary burner adjustments made. Make certain the readings are recorded and used as a basis of comparison for future tests. Combustion adjustments should only be made by those thoroughly familiar with all aspects of burner adjustment and combustion.
8. Inspect mercury switches. Inspect mercury switches for contamination, loss of mercury, and cracked or broken wires. Replace if any of these conditions are found.

## **Annual Maintenance**

**Note: Annual maintenance should be coordinated with the annual pressure vessel inspection performed by insurance or government groups. Establish a firm procedure with all outside inspection groups so that your equipment will be in a proper state of readiness. As a matter of routine, establish a procedure using good safety practices whenever a boiler is taken off the line. Disconnect all power supplies and lock switches in the off position. Whenever there is more than one boiler connected to a common header establish a routine procedure of locking the header valve on any unit that is down for cleaning or inspection, close any flue gas outlet dampers, and all pieces of equipment required to isolate the boiler.**

1. Clean fireside surfaces by brush or use a powerful vacuum cleaner to remove soot. After the cleaning process and if boiler is to be left open, it is advisable to spray all fireside surfaces with some type of corrosion preventative.
2. Clean breeching. Inspect breeching and stack and remove any soot build up.
3. Clean waterside surfaces. Remove all handhole and manway plates,

inspection plugs from water column tees and crosses and float assemblies from water columns. Thoroughly wash all waterside surfaces.

4. Check oil storage tanks. Oil storage tanks should be inspected for sludge and water accumulation. Keep the tank filled with oil to prevent condensation during summertime.
5. Check fluid levels on all hydraulic valves. If any leakage is apparent, take positive corrective action immediately.
6. Check gauge glass for possible replacement. If internal erosion at water level is noted, replace with new glass and gaskets. On all unattended boilers, the gauge glass mounting should be of the safety style with stop-checks in case of glass breakage.
7. Remove and recondition safety valves. Have them reconditioned by an authorized safety valve facility. The safety valve is an important device yet possibly receives less attention than any other device. See additional information later in this chapter.
8. If oil fuels are used, check on the condition of the fuel pump. Fuel pumps wear out and the annual inspection time is the opportune time to rebuild or replace them.
9. Boiler feed pumps. Strainers should be reconditioned. Feed pump elements wear and must be replaced. Sometimes a review of the condensate return system and chemical feed arrangement will reveal causes of short pump life. See additional information later in this chapter.
10. Condensate receivers should be emptied and washed out. Make an internal inspection, if possible. If the receiver has a make-up valve mounted, it should be overhauled and checked for proper operation.
11. Chemical feed systems should be completely emptied, flushed and reconditioned. Metering valves or pumps should be reconditioned at this time.
12. Tighten all electrical terminals. All terminals should be checked for tightness, particularly on starters and movable relays.
13. Check deaerator or boiler feed systems. Inspect them to ensure they are not contaminated, corrosion is not taking place and that the lining has not deteriorated and fallen off. Check all other mechanical aspects of the equipment. See information later in this chapter.
14. Check linkages. Check to ensure the linkage ball connectors have not worn out. Worn connectors can cause inconstancy in the linkage movement and result in unrepeatability in excess air levels in the combustion process.

## **Boiler Room Log**

During operation, there are certain procedures that should be performed by the operating personnel. The best way to keep track of procedures and to help remind the operator to perform certain functions is to keep a boiler room log. For a log to be effective, it must provide a continuous record of boiler operation and maintenance and record any unusual observations. The number and frequency of the checks to be performed depend on the type of boiler room installation. The Hartford Steam Boiler Inspection and Insurance Company, in their Engineering Bulletin No. 70 "Boiler Log Program," explains why a log is desirable, and also points out the various tests to be performed on the equipment or apparatus. Bulletin No. 70 recommends the various tests to be performed and the frequency of log entries as follows:

- 1. Low Pressure Steam and Hot Water Heating Boiler Logs - Weekly Readings*
- 2. High Pressure Power Boiler Log, for relatively small plants that do not have constant attendance - Twice Daily readings with more frequent checking while in operation.*
- 3. High Pressure Power Boilers, larger units in large plants - Hourly Readings, the preferred frequency for all high pressure boilers.*

In the interest of accident prevention and safe operating and maintenance practices, the Hartford Steam Boiler Inspection and Insurance Company and Cleaver-Brooks Division of Aqua-Chem, Inc., offer without cost or obligation, copies of the boiler room logs. Consult your Cleaver-Brooks Representative or write to The Hartford Steam Boiler Inspection and Insurance Company, One State Street, Hartford, Connecticut 06102-5024.

## **Low Water Cutoff**

Statistics show that by far the largest number of preventable accidents involve the overheating of a boiler. Most of the occurrences are due to low water conditions.

The statistics in Chapter 3 (see pages 3-11, 3-12) point out how important it is to keep the low water cutoff in proper working condition. There are several ways in which the low water cutoff can be checked.

The most recommended method when the boiler is operating is to shut off the supply of feedwater to the boiler. If the boiler is equipped with its own individual boiler feed pump, the pump can be shut off. If more than one boiler is being supplied from the same pump, then a valve in the feedwater line to the boiler can be closed. With the supply of water to the boiler shut off, the water level will slowly drop until it falls to the point where the low water cutoff

mechanism should actuate and shut the burner down. This is known as an evaporation test. The test should be performed only under close supervision and when the boiler is operating at low fire conditions. The low water cutoff should activate before the water disappears completely from the gauge glass.

When blowing down the gauge glass and the water column, the operator should carefully observe the action of the water in the glass. When the drain valve is closed, the water level should recover promptly. If the water level is slow or sluggish in returning to its normal level, it is an indication there is some obstruction partially blocking the flow of water into the control chamber. If the apparent obstruction cannot be cleared up by blowing down, then the boiler should be shut down and cooled off so the water column float (or probe) chamber can be opened up and inspected. If there are any mud, scale, or sediment deposits, they should be removed completely. The float and linkage should be examined to make sure everything is in good working order. All of the connecting piping should be inspected and, if necessary, rodded out to remove any obstructions.

On a steam boiler, the head mechanism of the low water cutoff device(s) should be removed from the bowl at regular intervals to check and clean the float ball, the internal moving parts, and the bowl or water column.

In addition and at the same time, remove the pipe plugs from the tees or crosses to make certain the cross connecting piping is clean and free of obstructions. Controls must be mounted in a plumb position for proper performance. Determine that piping is vertically aligned after shipment and installation and throughout the life of equipment.

A scheduled blowdown of the water controls on a steam boiler should be maintained.

On a hot water boiler, it is impractical to blow down the low water cutoff devices since the entire water content of the system would become involved. In addition, since many hot water systems are fully closed, any loss of water will require makeup and additional feedwater treatment that might not otherwise be necessary. Since the boiler and system arrangement usually makes it impractical to perform daily and monthly maintenance of the low water cutoff devices, it is essential to remove the operating mechanism from the bowl annually or more frequently if possible to check and clean the float ball, internal moving parts, and the bowl housing. Also check any cross connecting piping to make certain that it is clean and free of obstruction.

## **Safety And Relief Valves**

Another extremely important safety check that should be performed is the

testing of all safety and relief valves. How frequently the test should be done is an extremely controversial subject. Everyone seems to agree that safety and relief valves should be checked or tested periodically, but very few agree as to how frequently they should be tested.

The ASME book on "Recommended Rules for Care and Operation of Heating Boilers," Section VI, states that the safety or relief valves on steam or hot water heating boilers should be tested every thirty days. A try lever test should be performed every thirty days that the boiler is in operation or after any period of inactivity. With the boiler under a minimum of 5 psi pressure lift the try lever on the safety valve to the wide open position and allow steam to be discharged for 5 to 10 seconds (on hot water boilers hold open for at least 5 seconds or until clear water is discharged). Release the try lever and allow the spring to snap the disk to the closed position.

An optional method that may be preferred by the owner or operator is to slowly build up the pressure in the boiler until the popping point of the valve or valves is reached. As soon as the valve(s) pop, cut back on the firing rate or shut the burner off and allow the pressure to drop back to its normal operating range. This procedure should be followed once or twice a year.

The ASME book on "Recommended Rules for Care of Power Boilers," Section VII, does not list any specific period of elapsed time between testing of safety valves. The book does state that all safety valves should be kept in good working order at all times. The best time for testing the safety valves or relief valves on power boilers and high temperature hot water boilers (HTW) is just prior to the shutdown for mandatory inspection. The safety valves can be tested while operating at low output and throttling the non-return or boiler stop valve until the lowest set safety valve relieves. Normal pressure should then be restored by slowly opening the non-return valve. The valve which relieved may then be gagged and the procedure repeated until all valves have been checked.

If the boiler is the type where a stop or non-return valve is omitted, close the prime mover throttle valve and test the valves by raising the pressure by varying the firing rate. Use the vent or drain valves on the superheaters, reheaters, or steam piping to provide the minimum flow necessary to prevent any overheating. Install temperature measuring devices at the critical points to assure that safe metal temperature limits are not exceeded.

The location of the critical points should be obtained from the boiler manufacturer.

To hand lift or test the valve operation with the boiler operating at design pressure, raise the lift lever to the full open position, then release to allow

the valve to snap closed as it would have, had it opened automatically. Safety valves shall not be opened with the hand lifting gear when the steam pressure is less than 75 percent of the normal opening pressure of the lowest set valve on the boiler.

When a safety valve fails to operate at the set opening pressure, do not attempt to free it by striking the body or other parts of the valve. The valve may be opened with the lifting lever and allowed to close, after which the pressure of the boiler should be raised to the selected pressure for which the valve is set to pop. If the valve does not then pop, the boiler should be taken out of service and the safety valve cleaned or repaired, by an authorized repair station for the valve manufacturer.

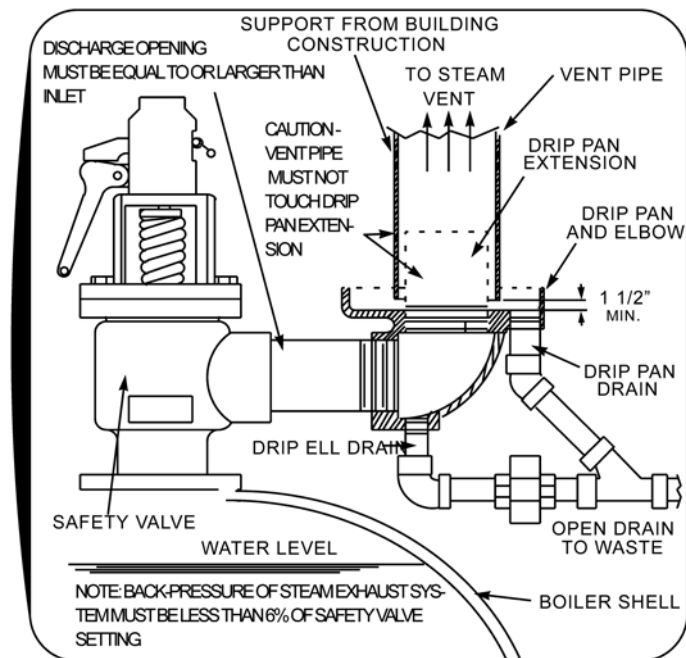

**Figure 1-29: Recommended Piping For Steam Relief Valve  
(Not furnished by Cleaver-Brooks)**

Do not try to stop valve leakage by compressing of the spring or by blocking it. When a safety valve leaks at a pressure less than that at which it is set to close, try to free the valve by operating the lifting lever; if this does not stop the leaking, repair or replace the safety valve as soon as practicable.

Safety or safety relief valve discharge piping is important to ensure proper operation of the valves (see Figure 4-1).

### **Burner And Controls**

During normal operation, maintenance of the burner and controls is extremely important. If the operation is of such a nature that the boilers are firing continuously day and night around the clock, most of the maintenance and repairs that can be made under these conditions are of a minor nature.

Spare oil guns or oil tip and swirlers should be kept cleaned and ready to be changed as necessary. Keeping a spare oil gun on hand is recommended. Check all of the valves in the fuel lines, feedwater and steam lines for leaks and packing gland conditions. Repair, repack and tighten where possible.

Check out burner linkage, jackshafts, drive units, cams, etc. Make sure all linkage, linkage arms and connections are tight. Lubricate or grease where required. Note any wear or sloppiness in any of this equipment. If it cannot be repaired while the boiler is in operation, then it should be noted in the log book so proper repairs can be made when the boiler is taken out of service.

Operation of the burner should be observed. Is the burner firing properly? Check the flame shape and combustion. If the burner is not operating properly, arrangements should be made to have a factory trained representative work on the burner to correct deficiencies.

Operating controls will normally function properly for long periods of time. For this reason, some operators become lax in their daily, weekly, or monthly testing, assuming that normal operation will continue indefinitely. Malfunctions of controls leads to uneconomical operation and damage and in most cases, conditions can be traced directly to deficiencies in testing and maintenance. Here is where use of the boiler room log becomes extremely useful. When a boiler room log is kept with complete and accurate entries of operating conditions, the entries can be very helpful in detecting malfunctions or pinpointing trouble.

Normal and proper operation of a boiler usually follows a distinct pattern. When readings and tests are made and entered in the boiler room log, these entries define the pattern. Any deviation from the pattern should be checked into and, if possible, determined what is causing the change in operating conditions. Changes in the readings can be gradual over a prolonged period of time or it can be a sudden change. The gradual change can be something like a slow increase in the flue gas temperature. An increase in flue gas temperature can be caused by a loss in heat transfer caused by sooting up of the boiler on the fireside surfaces, baffle leakage or scale buildup on the waterside surfaces. A sudden or rapid change in some of the readings can indicate the fuel-air ratio has changed due to linkage slipping, damper movement, fuel or air cam adjustment screws changed, or a multitude of other points that can go out of adjustment.

## **Feedwater Treatment**

Improper water treatment is probably the largest direct cause of boiler failure. When the boiler feedwater and the boiler water do not receive proper preparation and treatment, scale and sludge deposits, corrosion and pitting

of the boiler surfaces result. The boiler owner and operator must know that proper boiler feedwater treatment is an absolute necessity.

Unless the boiler receives water of proper quality, the boiler's life will be needlessly shortened. The services of a "QUALIFIED BOILER FEEDWATER CONSULTANT" should be utilized. They would have to carefully study the plant conditions, materials employed, pumps, lines, heat users, prevailing water chemistry, etc., to establish a good boiler feedwater treatment program to accomplish the following:

- Prevent scale and deposits
- Remove dissolved gases
- Protect against corrosion
- Eliminate of carryover
- Correct against embrittlement
- Save on fuel and maintenance
- Achieve highest boiler efficiency
- Minimize of boiler outages

A properly executed boiler feedwater treatment program, along with proper blowdown procedures, will normally maintain the waterside surfaces in good condition. If fireside corrosion and erosion conditions are kept to a minimum, the boiler pressure parts should enjoy a long and useful life.

### **Boiler Blowdown**

When a boiler is generating steam, the feedwater continuously carries dissolved mineral matter into the unit. The material remains in the boiler shell or drum, causing an increase in the total solids until some limit is reached beyond which operation is unsatisfactory. Many difficulties in boiler operation occur because of excessive concentrations of sludge, silica, alkalinity, chlorides, or total dissolved solids.

To prevent an excessive accumulation of dissolved and undissolved solids which will interfere with proper boiler operation, a blowdown program should be established.

The amount of blowdown or number of times the boiler is blown each day depends upon the concentration of solids in the boiler water. It is not possible to include any specific recommendation for blowing down a boiler because of the difference in the composition of the water that is used for makeup. Recommendations of the feedwater consultant should be followed regarding blowdown procedure.

Further, at installations where the condensate returns represent a high percentage of the total feedwater, it can generally be assumed that the amount of water that must be blown to waste to properly control the concentrations within the boiler may be relatively small in comparison to an installation at some other location. If no condensate return is available, then it is necessary to employ some means of establishing the frequency of blowdowns that are required to eliminate any trouble that would be caused by steam contamination, or any of the other aforementioned difficulties.

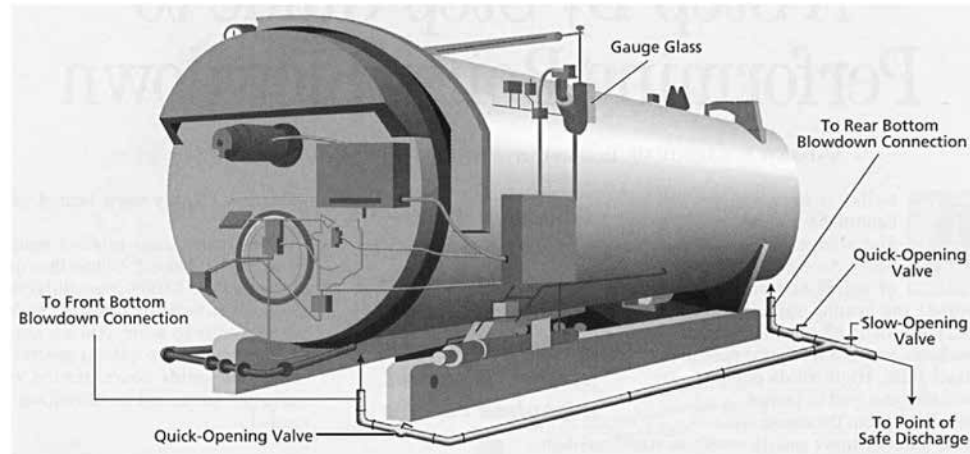

**Figure 1-30: Blowdown Valves And Piping Arrangement**

Bottom blowoff valves are primarily meant to be used as drain valves; however, it is frequently necessary to use the blowoff valves to get rid of mud and sludge that have settled to the bottom of the boiler shell or drum. Generally, when boilers are being operated at or near rated capacity, the circulation is great enough that the mud and sludge do not have much chance to settle out.

When necessary to blow down the boiler through the blowoff valves (see Figure 4-2), they should be opened slowly and carefully. The boiler should be blown down at lower firing rates. Blowoff valves should be closed tightly after blowdown is completed. The boiler should be equipped with either two slow-opening valves or one quick-opening valve and one slow-opening valve piped in series. If the boiler has more than one bottom blowdown connection, a second quick-opening valve is needed. The following steps should be taken to blow down a boiler.

1. Open the quick-opening valves (ones closest to the boiler).
2. Open the slow-opening valve.
3. Blow down the boiler for the amount of time specified by your water treatment consultant by opening and closing the slow-opening valve. Pay close attention to the water level in the gauge glass. Some loads require

several short blowdown cycles to maintain the proper water level in the boiler.

4. Close the slow-opening valve.
5. Close the quick-opening valve(s).
6. Open the slow-opening valve again to drain the line between the quick and slow-opening valves.
7. Close the slow-opening valve again and double check that the shutoff is tight after the valve has cooled off.

**Note: Never pump the quick-opening valve to blow down the boiler. Such action could cause water hammer and damage piping and valves. It could also cause personal injury. Never leave an open blowdown valve unattended. Remember the valve(s) closest to the boiler must be opened first.**

Blowdown valves on economizers are provided to serve primarily as drain valves, and this type of equipment should never be blown down in the ordinary sense while the boiler is in active steaming service, except under conditions specifically recommended by the manufacturer.

Continuous blowdown or surface blowdown from a location designated by the boiler manufacturer is generally preferable to intermittent blowdown for control and solids concentrations. The boiler water may be flashed at one or more lower pressures and valuable heat recovered.

It is good operating practice just before cutting a boiler into service to give the boiler a good blowdown. This action helps to start circulation in the boiler before picking up load.

## **Deaerator**

Deaeration (degasification) is one of the most important steps in boiler water treatment. Both the low pressure condensate return and the treated makeup water requires deaeration prior to passage to the boiler feed pumps. If degasification is carried out external to the boiler, a mechanical process is usually applied. Such a process depends on the decrease in solubility of dissolved gases as the water temperature is increased. The principle gases which are removed by deaeration, because of their contribution to corrosion, are oxygen and carbon dioxide.

The basic principle of deaeration is to heat the incoming water up to a temperature that causes the entrained gases to flash out of solution. The best results in releasing the gases can be obtained with steam at a pressure of not less than 5 psi (227°F). An atmospheric type of heater will only partially

remove the gases. The column and spray types of deaerators are designed to operate under a positive pressure of 5 psi or greater. The amount of maintenance required to keep the average deaerator in operating condition is very minimal. With a column-type deaerator, there is a tendency to scale if there is the least amount of hardness in the water going to the deaerator. If this scale deposit should build up, it will impede the flow of water through the packing rings in the column, reducing the effectiveness of the deaeration process.

The packed column type of deaerator may or may not be cleaned with acid solution depending on the type of packing in the column. If the column packing is stainless steel, then acid cleaning could be used. The column as well as the deaerator tank and all the piping should be thoroughly washed and back-washed.

The spray type deaerator will generally have a spray valve or spray pipe. With the spray valve, it may be necessary to check the valve seat for wear or pitting. The spring compression dimension should be checked and adjusted to manufacturer's recommendations. If the deaerator has a spray pipe, then the pipe should be inspected to see if all of the spray holes are open. If any holes are plugged, they should be opened.

Strainers in all lines should be cleaned at regular intervals determined by conditions and usage; water gauge glasses should be kept clean and replaced if necessary. Tighten all packing glands and fittings to eliminate steam and water leaks. The overflow valve and makeup valve with their associated level control mechanisms should be checked out. Refer to appropriate manufacturer's literature for service recommendations on the particular components.

Pressure reducing valves feeding steam to a deaerator should be maintained in accordance with the manufacturer's recommendations.

### **The Economizer**

Soot deposits from firing heavy oil and/or improper combustion on all fuels can stick on the economizer tubes and cause plugging between the tubes or between the fins. Soot deposits cut down the efficient operation of the economizer, cause corrosion from any sulfur in the fuel and increase the draft losses.

If the economizer is plugged with deposits, they should be removed. If the deposits are fairly soft, it is quite possible they can be blown out with an air lance. Hard deposits can best be removed by poking between the tubes. If the breeching beneath the economizer is built so it can be drained, a jet stream of water can be used to wash out the deposits. When water is used, the surfaces must be washed completely to remove all traces of sulfur. The surfaces should then be dried quickly to prevent any rust or corrosion from starting. The drying could possibly be done by closing the access doors and blowing air from the forced draft fan through the unit, or by blowing with an air lance to dry off the water.

Decreased loads on the boiler result in lower flue gas temperatures, and the possibility of condensation of moisture from the flue gases. Moisture, with sulfur compounds from the flue gas, will cause corrosion of the surfaces of the economizer.

Corrosion can be caused by nonuniform flue gas distribution resulting in pockets of stagnation. The best solution is to operate the boiler at loads high enough to raise the flue gas temperatures to above their dewpoint. If this is not a workable solution, then mechanical changes to the system are recommended. One such change may be to decrease the flow of boiler feedwater through the economizer using a bypass arrangement, thus raising the temperature of the flue gas to eliminate the condensation.

A second option might be the installation of a preheater to raise the temperature of the water entering the economizer.

A third option might be to provide duct work to allow the flue gas to completely bypass the economizer during periods of operation at low loads on the boiler.

The water side of the economizer should be opened up and inspected. Remove one or more handholes in each header and inspect for scale buildup, deposits, sediment, etc. Any mud, scale or sediment in the headers should be cleaned out or washed out. The tubes should be inspected for scale deposits and plugging. If the tubes are plugged or scaled heavily enough to impede flow or heat transfer, then the deposit should be removed. The deposits can be removed either by chemical or mechanical means.

The tubes should also be examined for internal corrosion. Any corrosion of the internal surfaces is most frequently due to dissolved oxygen in the feedwater. Precautions must be taken to provide proper conditioning if difficulty is to be avoided. The water supplied to an economizer should be properly deaerated and treated by the addition of chemicals.

### **Feedwater Pump(s)**

One of the most important times in the life of a pump is when it is installed. Proper installation at this time will do more towards pump longevity than any other one item. The pump should be very carefully leveled, grouted and aligned before it is piped. Then to make sure the piping has not distorted the pump housing or pulled it out of alignment, the pump should be checked again and realigned if necessary.

During periods of operation, there is very little that can be done except to check it periodically to make sure everything is functioning normally. Bearing temperatures should be checked. At the same time bearing temperatures are being checked, the vibration can also be observed. Packing gland adjustment can be done and, depending on types of lubrication methods employed, lubrication of the bearing can be done.

Just like other pieces of equipment in a boiler room, the pumps should be taken out of service on a preplanned schedule for monthly, semi-annual and annual inspections. At that time the bearings should be checked carefully, lubricant replaced or added. Flexible couplings should be opened up, checked for wear and alignment, washed out thoroughly and reassembled

with new lubricant.

During the same inspection, the pump seals can be inspected and, if necessary, replaced. If the pump is equipped with mechanical seals and they are working all right, then probably the best advice is to leave them alone. If the pumps are equipped with a packing type seal, they should be inspected and repacked if necessary.

Any suction or discharge strainers should be inspected, opened up and cleaned. Suction and discharge piping should be checked for proper support, leaks, etc. If the boiler room log entries indicate that the pump performance has fallen off appreciably, perhaps overhaul of the pump is advisable. Rotor wear and increased clearances will affect pump capacity and discharge pressure. If a major overhaul of the pump is indicated, the pump manufacturer should be contacted for instructions and recommendations.

## **Fuel Systems**

In order for any boiler to be able to operate at peak efficiency and as trouble-free as possible, the fuel handling system must be designed properly and must also be maintained in top condition at all times.

Full and effective use should be made of manufacturers' instruction books on operation and maintenance. Of special importance are written procedures prepared expressly for each installation. Fuel burning equipment should never be operated below the safe minimum level at which a stable flame can be maintained. In like manner, operation at rates of fuel input which are excessive in relation to available air supply should not be tolerated.

Natural gas and fuel oils are the most common fuels used in the currently popular firetube and watertube packaged boiler. Most of these units are automatic in their operation with some semi-automatic controls being used.

The gas train in its simplest form for automatic burner boiler unit will consist of:

1. Manual shutoff valve(s) (or cock).
2. Safety shutoff valve(s). (This valve is an automatic valve that is actuated to open or close at the direction of the flame safeguard control.)
3. Fuel flow control valve (butterfly valve). (This valve is actuated by the combustion control system or flame safeguard and modulates to control the flow of fuel to the burner. It is not a fuel shutoff valve.)

More sophisticated fuel trains to satisfy various code and insurance groups require additional shutoff valves (manual), dual safety shutoff valves (automatic) with automatic vent valve in between, high and low gas pressure

interlock switches and also proof of closure switches on one or more of the automatic shutoff valves.

The entire gas train should be checked carefully to ensure every component is in good working order. Strainers in the gas line should be opened up and the strainer baskets cleaned. Inspect the strainer body internally while the basket is removed. Be sure there is not any lint, dirt, scale, etc., that may be dislodged with the removal of the basket that could be blown on through the gas line when the gas pressure is turned on again. Check gas burners for presence of dirt, lint, or foreign matter. Be sure ports, gas passages, and air passages are free of obstructions. Linkages, belts and moving parts on power burners should be checked for proper adjustment. On combination oil and gas burners, the gas outlets may become caked with carbon residue from unburned fuel oil after prolonged periods of oil firing and require cleaning. Lubricate components in accordance with manufacturer's recommendations. Also check the pilot burner. Clean and inspect the electrode for igniting the pilot flame. Space and regap the electrode if necessary. Check the ignition equipment and pilot burner for flame adjustment and performance.

**Note: Under no conditions should fuel train piping (gas or oil) be fastened to or located near the side casing of an industrial watertube packaged boiler.**

The reason is safety. In the event of a fireside furnace occurrence in an industrial watertube packaged boiler, the side casing will usually be bulged outward or torn loose from the force of the occurrence. The gas or oil train piping fastened to or in close proximity to the casing could be ruptured by the bulged casing, in which event raw fuel (gas or oil) would be released in the boiler room.

In the case of an oil burner or combination gas and oil burner, the oil supply train should be checked out and inspected as diligently as the gas equipment.

Oil burners require periodic maintenance to keep the nozzle and other parts clean. Check and clean oil line strainers. Inspect and check the nozzle. Check and clean filters, air intake screens, blowers and air passages. Check all linkages and belts, and adjust as required. Lubricate components in accordance with manufacturer's recommendations. Check pilot burners and ignition equipment for proper flame adjustment and performance.

The oil piping, both suction and return from the storage tanks to the burner, should be checked over thoroughly, inspecting for leaks, corrosion, and physical damage.

Where light oil only is being used, the piping and pumping system is fairly simple. Generally such a system consists of one or more pumps, designed for pumping the required amount of light oil, suction strainer, discharge strainer, piping, valves and gauges. Normal maintenance on the pumps should include checking and repacking or replacing of the seals if necessary. Check bearings and lubricate if necessary, check coupling alignment and realign if required, clean and lubricate, if necessary. Any leaks in the piping or valve packing glands should be tightened or repaired.

If the burner is designed to burn residual grade fuel oil, then a fuel oil heater and all of the necessary control components will also need to be inspected to ensure that the system is in satisfactory working order. Steam and oil pressure regulators as well as temperature controls should be monitored to ensure that they function as required and are adjusted to the appropriate temperature and/or pressure. It is possible for residual fuel oil to foul up the surfaces of the heater should flows or temperatures go beyond normal operating limits. The exchanger may become fouled with carbon or sludge, which will necessitate disassembly and physical cleaning to restore it to its original performance.

**Notes**

# CHAPTER 5

## SHUTTING DOWN

### GENERAL

When a routine shutdown is scheduled, it should be planned so there is time to perform certain operations in the shutdown procedure.

1. If the boiler is equipped with sootblowers, and any other fuel other than natural gas has been fired, the sootblowers should all be operated before taking the boiler off the line.

All the recommended rules for operating the sootblowers should be followed. One of the most important rules is that the steam load on the boiler is 70% of boiler rating or greater. Operation at low load, with its resulting colder furnace may result in some unburned combustibles escaping from the furnace, and redepositing on the tubes or collecting in pockets. Agitation of the combustibles during sootblowing at low load may result in an occurrence. Therefore, it is important to have all of the areas of the gas passes thoroughly swept with flue gas, thus purging any combustible gas from pockets where it may collect.



*Figure 1-31: Boiler with front head swung open. The front tube sheet tubes and burner housing are exposed for inspection and maintenance.*

2. After the sootblowing operation is complete, the steam flow from the boiler should be gradually reduced and the burner run to the low fire position.
3. With the burner in low fire position, blow down the boiler (as explained previously in Chapter 4) along with the water column, gauge glass, and feedwater regulator. Turn the burner off in accordance with the burner manufacturer's instructions. If the boiler is equipped with a flue gas outlet damper, it should be fully closed to allow the unit to cool slowly.
4. Remove and clean the burner oil gun. Place the fuel supply equipment in standby condition (for gas, shut main supply cock). Throw the main electrical switch, and take the feedwater regulator out of service. Hand operate the feedwater valves to keep the water level above one-half (1/2) gauge glass.
5. When the boiler pressure falls below line pressure, the boiler stop valve should be closed if the setting has cooled enough to prevent any pressure buildup. If the boiler is equipped with a non-return valve, the valve should close automatically when the boiler pressure drops below line pressure. This, of course, isolates the boiler from other units remaining in service. As the drum pressure falls below 15 to 25 psi, the manual closing device (handwheel) of the non-return (if equipped) should be closed and the vent valve on the boiler opened. This will prevent a vacuum on the boiler waterside, which will loosen well set gaskets and cause future problems. While there is still a small amount of steam pressure available, the boiler should be blown down and filled back to a safe level with freshly treated hot water in preparation for the next startup.

If the boiler is being shut down just for overnight or for the weekend, the foregoing procedure is generally all that is required. The primary concern is to make sure there is sufficient water in the boiler. If the boiler is only going to be shut down overnight, the boiler can be secured and will have pressure still showing the next morning. When the boiler is insulated well enough to permit steam pressure to remain overnight, there is no danger of pressures dropping low enough to start pulling a vacuum. Then the boiler vent valve can be left closed.

In those instances where the boiler may be left unattended long enough that the boiler cools down and does start to pull a vacuum, the piping can be equipped with a vacuum breaker valve. The valve can be installed close to the top of the steam drum or shell, preferably above the water line. As the boiler cools down and the condensing of the steam starts to form a vacuum, the valve permits air to enter the drum and atmospheric pressure will exist in the drum. One precaution must be taken in such an installation. When starting up the boiler each time, be sure the boiler vent valve is opened to evacuate all

the air that has been trapped in the boiler and boiler water.

Up to this point, we have been talking about shutting down the boiler for just a few hours or a few days. If the boiler is going to be taken out of service for several weeks or several months, then a different procedure must be followed.

## WET STORAGE

There are two (2) basic methods of laying up a boiler for extended periods of time. They are wet and dry storage.

If the unit is to be stored for no longer than a month and emergency service is required, wet storage is satisfactory. Wet storage is not generally employed for boilers that may be subjected to freezing temperatures. Several alternative methods may be employed.

1. The boiler to be stored should be closed and filled to the top with chemically treated feedwater or condensate, to minimize corrosion during standby storage. Water pressure greater than atmospheric pressure should be maintained within the boiler during the storage period. A head tank may be connected to the highest vent of the boiler to maintain pressure above that of atmospheric pressure.

For short periods of wet storage, the water or condensate in the boiler should contain approximately 450 PPM of caustic soda and 200 PPM of sodium sulfite. If the boiler is equipped with a superheater of the drainable type, it can also be filled with the above described treated water by overflowing from the boiler.

If the superheater is non-drainable, it should be filled with condensate or demineralized water containing no more than 1 PPM of dissolved solids. Before introducing the water into the superheater, sufficient hydrazine should be added to achieve a concentration of about 200 PPM. Sufficient volatile alkali should also be added to produce a pH of 10. The treated water may be introduced into the superheater through an outlet header drain until the water flows into the boiler. When the superheater is filled, close the vents and drains. This quality of water may also be used in the boiler. If the storage period should extend beyond a month, the concentration of hydrazine should be doubled.

2. As an alternative, the boiler may be stored with water at normal operating level in the drum and nitrogen maintained at greater than atmospheric pressure in all vapor spaces. To prevent leakage of air, it is necessary to supply nitrogen at the vents before the boiler pressure falls to zero as the boiler is coming off the line. If boiler pressure falls to zero, the boiler should be fired to re-establish pressure and drums and superheaters thoroughly vented to remove air before nitrogen is admitted. All partly filled steam

drums and superheater headers should be connected in parallel to the nitrogen supply. If nitrogen is supplied only to the steam drum, nitrogen pressure should be greater than the hydrostatic head of the longest vertical column of condensate that could be produced in the superheater, or a minimum of 5 psi.

3. Rather than maintain the water in the boiler at normal operating level with a nitrogen cap, it is sometimes preferred to drain the boiler completely, applying nitrogen continuously during the draining operation and maintaining a pressure of nitrogen greater than atmospheric throughout the draining and subsequent storage.

## DRY STORAGE

Dry storage is preferable for boilers out of service for extended periods of time or in locations where freezing temperatures may be expected during standby.

The cleaned boiler should be thoroughly dried, since any moisture left on the metal surface would cause corrosion. After drying, precautions should be taken to preclude entry of moisture in any form from steam lines, feed lines, or air.

A moisture absorbing material should be used, such as quicklime, at the rate of two (2) pounds or silica gel at the rate of five (5) pounds for 30 cubic feet of boiler volume. It may be placed on desiccant trays inside the drums or inside the shell to absorb moisture from the air. The manholes should then be closed and all connections on the boiler should be tightly blanked. The effectiveness of the materials for such purposes and the need for their renewal may be determined through regular internal boiler inspections.

We would strongly recommend that large signs be placed in conspicuous places around the boiler to indicate the presence of moisture absorbing materials. The message to be conveyed can be as follows:

**Note: Moisture absorbing material has been placed in both the fireside and waterside of this boiler. These materials must be removed before any water is introduced into the boiler and before the boiler is fired.**

For long periods of storage, internal inspections should be performed to assess the condition of the moisture absorbing materials. Such inspections should be initiated monthly, unless experience dictates otherwise. The moisture absorbing material increases in volume as moisture is absorbed, making it necessary to use deep pans. Fresh material should be substituted as needed at the time of the inspection.

Alternatively, air dried externally to the boiler may be circulated through it. The distribution should be carefully checked to be sure the air flows over all areas.

If the boilers are going to be stored in any place other than a dry, warm protected atmosphere, then steps should be taken to protect the exterior components also. Burner components that are subject to rust, such as jackshaft, linkage, valve stems, moving parts, etc., should be coated with a rust inhibitor and covered to protect them from moisture and condensation. Electrical equipment, electronic controls, relays, switches, etc., should be similarly protected.

Pneumatic controls, regulators, diaphragm or piston operated equipment should be drained or unloaded and protected so that moisture, condensation, rust, etc. will not damage the equipment during a long period of storage. Feedwater lines, as well as blowdown, sootblower, drain lines, etc., should all be drained and dried out. Valve stems, solenoid valves and diaphragms should all be protected by lubricant, rust inhibitors, plastic coverings or sealants.

# CHAPTER 6

## THEORY OF COMBUSTION AND THERMODYNAMICS

### INTRODUCTION

The previous chapters in the guide deal with boilers and related boiler room equipment. The end result of the boiler is to provide energy in the form of hot water or steam for either manufacturing process applications or building heat. An understanding of combustion and the basic of thermodynamics will assist in proper boiler operation, increased efficiency and extended equipment life.

Combustion - An act or instance of burning

Thermodynamics - Physics that deals with the mechanical action or relations of heat

## THEORY OF COMBUSTION

Combustion requires three items, heat, fuel and oxygen (see Figure 6-1). Heat is provided by the pilot. Fuel can be natural gas, propane, oil, coal, wood or solvents and/or by-products of a process. The third item is oxygen. By volume, air contains approximately 21% oxygen, 78% nitrogen and 1% miscellaneous gases.



**Figure 1-32: Elements of Combustion**

During the combustion process, we only use the oxygen in ambient air. The nitrogen is heated by the combustion process and exits the boiler. It has been found that nitrogen contributes to air pollution. During the combustion process, a nitrogen molecule will attach to an oxygen molecule and exit the boiler in the form of Oxides of Nitrogen, which are classified as NO<sub>x</sub>.

To maintain satisfactory combustion, once it has been started, there are three requirements: Time - time for the combustion process to take place; temperature - which comes from the combustion process; and turbulence - which is the mixing of the air and fuel.

All three must be considered when a boiler and burner combination is designed. They must also be taken into account when combustion or fuel/air ratios are set in a boiler.

During the design process of a boiler and burner, the size of the combustion air fan must be considered. The fan must provide sufficient air in CFM, so enough fuel can be added to make the full rated capacity of the boiler, plus a safety margin. The fan must also produce sufficient static pressure to overcome the pressure drop across the air damper, burner, diffuser and the combustion gas passes of the boiler. The fan provides the air for combustion and moves the combustion gases to the outlet of the boiler. The removal of the combustion gases from the outlet of the boiler to the top of the stack is a function of the breeching and stack sizing.

If there is a change in the system, after the original start up of new equipment, care must be taken to ensure the breeching and stack sizes are sufficient to remove the combustion gases from the boiler. Breeching and

stacks that are too small or too large can create problems.

Stoichiometric or perfect combustion is a term used to describe a condition when there is the exact amount - molecule for molecule - of air for the fuel attempting to be burned. Perfect combustion can be accomplished under laboratory conditions; however, it's not practical to attempt to meet the condition in a boiler. Stoichiometric combustion is the reference point used when setting fuel/air ratios in a boiler.

If combustion is set in a boiler and there is high excess air levels or the oxygen is rich and the fuel is lean, dollars will be spent to heat up the nitrogen in the ambient air. The heated nitrogen will go out the stack. This is not very cost effective. There also is the possibility that too much excess air at a given firing rate could result in unstable fires in the boiler.

Going the other direction, with too low excess air levels or lean oxygen and rich fuel, there is a different set of problems. The boiler may soot on the fireside but, more importantly, there may be excessive amounts of CO (Carbon Monoxide) in the combustion process. CO is unburned fuel and, under the right conditions, could reignite.

When combustion or fuel/air ratios are set in a boiler, readings must be taken to determine the O<sub>2</sub> levels in the combustion process. O<sub>2</sub> is the total amount of excess air in the combustion process, above the point of stoichiometric combustion. There must always be excess air in the combustion process to account for changes in boiler room conditions and to ensure that combustion is on the proper side of the combustion curve.

The only method available to determine the O<sub>2</sub> level in a boiler is to measure the combustion gases at the outlet of the boiler. The O<sub>2</sub> level cannot be determined by looking at the flame.

The O<sub>2</sub> levels through the entire firing range of the burner, low fire to high fire, should be tested. The burner manufacturer's recommendations on turndown should be followed and the turndown range of the burner should not be exceeded.

It's important there is an understanding of what the readings shown on an instrument refer to when setting combustion in a boiler. Figure 6-2 shows the relationship between O<sub>2</sub> levels, excess air and the products of combustion for a typical flue gas analysis for natural gas.

One of the products of combustion is CO<sub>2</sub> (Carbon Dioxide), which is shown as a percentage.

Another product of combustion is CO (carbon monoxide) and is shown in both percentage and parts per million (ppm). The maximum CO level

standardly allowed is less than 400 ppm (1/10 of 1% is 1,000 ppm). The instruments used today usually record CO in ppm. The maximum CO level allowed varies across the country.

Instruments today also measure O<sub>2</sub> in percent. The percent O<sub>2</sub> recorded on an instrument equates to percent excess air, i.e. 2% O<sub>2</sub> is approximately 10% excess air, 3% O<sub>2</sub> is approximately 15% excess air and 4% O<sub>2</sub> is approximately 20% excess air.

The exact percentage of excess air is a mathematical calculation based on an ultimate fuel analysis of the fuel being fired. Excess air is the percentage of air over stoichiometric or perfect combustion (0% O<sub>2</sub>).

If instrument readings were plotted as shown on the graph in Figure 6-2, they would provide the following information.

If there was a CO<sub>2</sub> reading of 9% (dot A), it could mean the combustion is on the proper side of the combustion curve and there is an excess air level of approximately 25%, or it could be on the wrong side of the combustion curve (dot B), producing CO, which is a dangerous situation. When setting combustion and only measuring CO<sub>2</sub>, it's very important to measure for CO to ensure which side of the combustion curve you are on. That is why most instrumentation used today measures O<sub>2</sub>.

From dot "A," if the fuel input increased without the air increasing or the air decreases and the fuel input remains constant and the O<sub>2</sub> level dropped to dot "C" (2% O<sub>2</sub>) there is still sufficient excess air (10%) above stoichiometric combustion to be on the proper side of the combustion curve. However the combustion ratio could result in the boiler sooting.

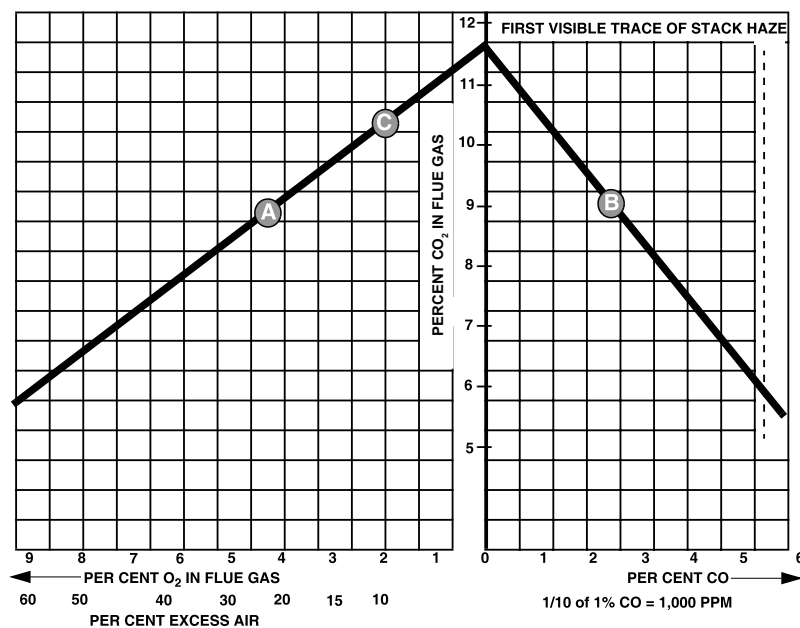

Figure 1-33: O<sub>2</sub> Trim System

If the problem is not corrected and the fuel continues to increase or the air decrease, it's possible to get to the point where there is a visible trace of stack haze, while firing natural gas. This is a very dangerous situation and can only be controlled through manual action by a qualified boiler operator. Changes in barometric pressure and ambient air temperature can effect combustion (see Table 6-1). Typically changes in barometric pressure result in small changes in excess air levels in the combustion process.

If, for example, combustion is set when the ambient air temperature is 80°F, the barometric pressure at 29" and an excess air level of 15% excess air or 3% O<sub>2</sub> and the barometric air pressure changes to 28", the excess air level drops to 11%. If the barometric pressure changes to 30" the excess air level increases to 19%.

However, a 20° or 30°F, change in ambient air temperatures can result in large changes in excess air levels. Using the same set up point of 80°F ambient air temperature, 29" barometric pressure and 15% excess air and the ambient air temperature changes 20°F. the changes in excess air levels will be greater. A drop in ambient air temperature to 60°F. will result in a rise in excess air to 20.2% or about a 4% O<sub>2</sub>.

If the O<sub>2</sub> levels are allowed to continue to rise, the boiler efficiency would be reduced and the possibility of unstable fires in the boiler could exist.

However, when going the other direction and the ambient air goes from 80°F. to 100°F., the excess air will drop to 9.6% or about a 1.9% O<sub>2</sub>.

This is still safe because it's above the point of stoichiometric combustion, but this condition could result in a soot build up in the boiler. Under this condition, the CO levels could increase and, if the excess air levels continue to drop, there could be a dangerous condition.

As the air in the boiler room gets hotter, the density of the air decreases and results in lower excess air levels. As the air in the boiler room gets cooler, the air density increases and results in higher excess air levels.

If, through the year, there are large temperature air changes (20° to 30°F) the combustion or fuel/air ratios should be readjusted several times a year to keep the boiler operating in a safe and efficient condition. Readjustment could be done during the spring and fall of the year.

An O<sub>2</sub> Trim system could be installed, under the right application, to help compensate for the varying conditions (refer to page 1-14).

One additional item to be aware of in a boiler room is ventilation air. 10 CFM per boiler horsepower of air available is required in the boiler room, 8 CFM for combustion and 2 CFM for ventilation. If the amount of air is reduced, it

will have an effect on combustion. While the recommendations are Cleaver-Brooks, local codes may supersede the requirements.

#### Effects of air properties

For a burner originally adjusted to 15% excess air, changes in combustion air temperature, pressure and humidity will have the following changes in excess air.

**Table 6-1: Effects Of Air Properties**

Air Temperature	Barometric Pressure	Resulting % Excess Air*	
40	29	25.5	
60	29	20.2	
80	29	15	(setup)
100	29	9.6	
120	29	1.1	
80	27	7	
80	28	11	
80	29	15	(setup)
80	30	19	
40	31	34.5	
60	30	25	
80	29	15	(setup)
100	28	5	
120	27	-5.5	

\* Expressed as a percentage of Stoichiometric air required.

## BASICS OF THERMODYNAMICS

### Law of Energy Conservation

The terms temperature, thermal energy, internal stored energy and heat are related to a specific law of energy: the Law of Energy Conservation. The Law of Energy Conservation states: “energy can be neither created nor destroyed, only altered in form.” In essence, the law states that all energy that exists must be accounted for.

For example, if a body’s temperature decreases, it has lost some of its energy. Because temperature is a measure of molecular energy, a decrease in temperature represents a decrease in the molecular energy of a substance. The energy has not been lost; however, it has been transferred out of the body in the form of heat. The transfer of heat out of a body causes the temperature of the body to decrease and the temperature of whatever surrounds it to increase.

The amount of heat transferred out of a body is equal to the amount of energy lost by the body. Therefore, all of the energy is accounted for.

The two units commonly used to measure heat are the British Thermal Unit (Btu) and Calorie (Cal). A Btu is defined as the amount of energy needed to raise the temperature of one pound of water one degree Fahrenheit.

A calorie is defined as the amount of energy needed to raise the temperature of one gram of water one degree Celsius. Btu’s are used for the examples throughout Chapter 6.

There is also a unit of measurement for the rate of heat transfer. The rate of heat transfer, often referred to as thermal power, is measured in units of Btu’s per hour. The rate of heat transfer is the amount of heat transferred into or out of a body per unit of time.

### Latent Heat of Fusion, Evaporation and Condensation

The addition of heat to a solid at its melting point produces a change of physical state instead of a rise in temperature. Thus, heat added to ice at 32°F. causes it to change to water at 32°F. When added heat produces a change of state instead of a change in temperature, it is called latent (hidden) heat. The amount of heat required to melt a unit mass (or weight) of a substance at its melting point is called its latent heat of fusion. Conversely, if a unit mass of water at 32°F. is sufficiently cooled so the heat is removed from it, then ice would form and its temperature will measure 32°F.

As the water changes state, there is no change in temperature. The process is called the latent heat of fusion. In order to change one pound of water at 32°F. to ice at 32°F., we must remove 144 Btu’s of heat from the water, (see Figure 6-3).

When heat is added to a liquid at its boiling point, a change in physical state is produced rather than a change in temperature. The amount of heat required to change a unit mass of water to steam at its normal boiling point is known as its latent heat of evaporation. Conversely, if a unit mass of steam at 212°F. is sufficiently cooled so that the heat is removed from it then water will form and its temperature will measure 212°F. This is known as the latent heat of condensation. Figure 6-4 shows the energy required to change water into steam and steam into water.

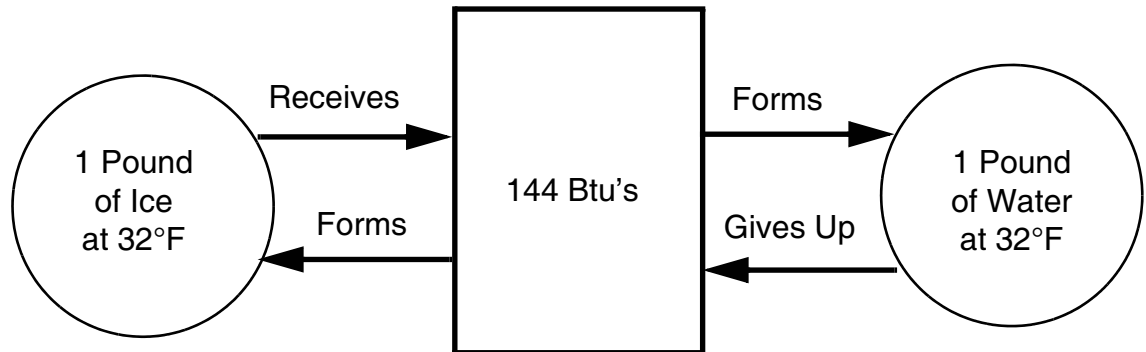

**Figure 1-34: Energy Required for Latent Heat of Fusion.**

Evaporation or vaporization occurs when molecules of the liquid phase, because of their internal kinetic energy, bounce out of the liquid phase into the gaseous or vapor phase. Vaporization of molecules from the liquid phase is known as evaporation; vaporization from the solid phase is known as sublimation. Since the rate of evaporation and sublimation depends on the energy of the particles, undergoing the change depends upon their temperature. Evaporation and sublimation occur more rapidly at higher temperatures and more slowly at lower temperatures.

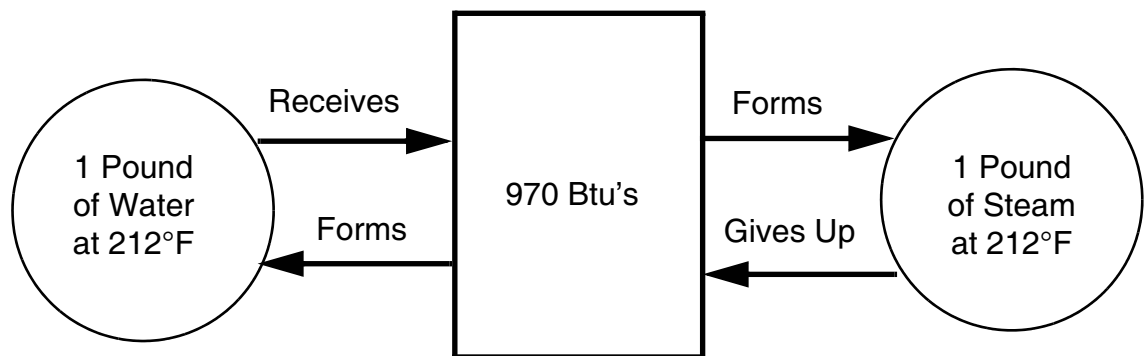

**Figure 1-35: Energy Required for Latent Heat of Evaporation or Condensation.**

The dashed line in Figure 6-5 is referred to as the saturation curve. At the top of the curve is a point called critical point. In the case of water, the critical point occurs at a pressure of 3206 psia and a temperature of 705°F. At the critical point, the latent heat of vaporization is zero, which means that any additional heat added can only result in a superheated vapor. A superheated vapor is a vapor whose temperature is higher than its boiling temperature.

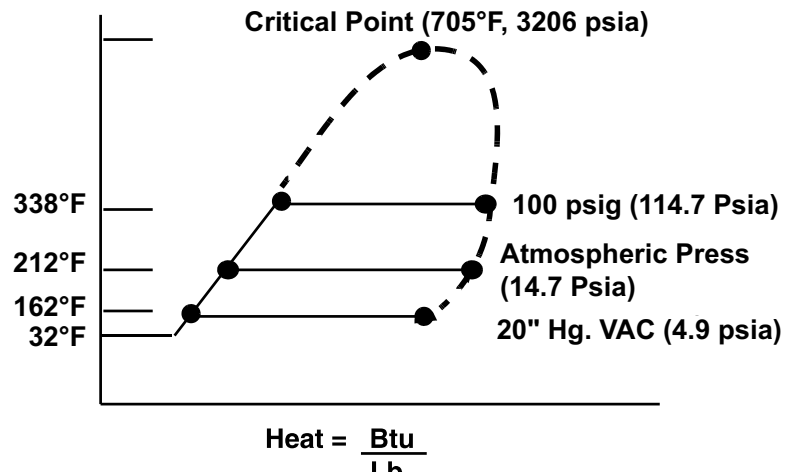

**Figure 1-36: Relationship of Pressure and Temperature to the Boiling Point of Water**

The points on the saturation curve, on the left side of the critical point, represent liquids at the boiling temperature for a given pressure. The points on the right side of the critical point represent vapor at the boiling temperature. Horizontal lines connecting the two points represent the latent heat of vaporization for various pressure conditions.

The boiling temperature of water is different at different pressures. For example, at atmospheric pressure, the boiling temperature of water is 212°F. At pressures lower than atmospheric pressure, the boiling temperature of water decreases, because the molecules of water are not forced as closely together. This means that the water molecules can escape the body of water more easily, which makes it easier for steam to form. On the other hand, at pressures above atmospheric, the boiling temperature of water increases, because the water molecules are packed so closely together that they require a temperature higher than 212°F. before they are able to escape the body of water.

The graph in Figure 6-5 can be used to explain the relationship of pressure and temperature to the boiling point of water. The line representing atmospheric pressure on the graph is used as a reference. As indicated on the graph, water at a pressure of 100 psig boils at approximately 338°F. The latent heat of vaporization at 100 psig is about 881 Btu's per pound, which means that the water vaporizes at a higher temperature above atmospheric pressure. It also takes less heat to make it change completely to steam. The reason is that the water molecules move more rapidly at higher temperatures, so it takes less heat to change the water into steam.

Similarly, at a vacuum of 20 inches of mercury, water boils at about 162°F and the latent heat of vaporization is about 1001 Btu's per pound, which means that water vaporizes at a lower temperature, but it takes more heat to make it change completely to steam.

## **Analysis of Temperature - Heat Diagram For Water At Constant Pressure**

Whether a substance exists as a solid, liquid or gas (water vapor), depends on its temperature, its heat content, and on the pressure to which it is subjected. Also the temperature of a substance depends on its heat content and its thermal capacity. As a confirmation of how these factors are related to the absorption and transfer of heat, consider the changes of state that occur and the work required to effect these changes when water is raised from 0°F to 300°F, see Figure 6-6.

The two terms, sensible heat and latent heat, are used to define heat as the water passes through the temperature range 0 - 300°F. Sensible heat is heat that can be felt and will change the temperature of the substance absorbing it. The flow of heat from one substance to another is normally reflected in the temperature changes of each substance - the hotter substance becomes cooler, the cooler substance becomes hotter.

When the flow of heat is reflected in a temperature change, sensible heat has been added to or removed from the substance. When the temperature is reached at which heat added or subtracted does not cause further change in temperature (as at the freezing or boiling points), a change in state takes place with the addition or subtraction of heat.

The heat necessary to cause one pound of a substance to change its state at the boiling or freezing temperature is known as latent heat; in changing from a liquid to solid or vice versa, it is known as the latent heat of fusion. In changing a liquid to a gas, the heat necessary is known as the latent heat of evaporation and, in changing from a gas to a liquid, it is known as the latent heat of condensation. The latent heat of fusion of water at 32°F. is 144 Btu per pound (freezing or boiling), and the latent heat of evaporation (or condensation) at 212°F. is 970 Btu per pound.

Heat is the flow of thermal energy. Adding or removing heat provides a temperature differential to allow energy to flow from one substance to another. Sensible heat and latent heat are two different kinds of effects that can be produced by heat, but not two different kinds of heat. Three physical states of all matter are solid, liquid, and gas (or vapor).

The physical state of a substance is closely related to the kinetic energy of its molecules. When the flow of heat to a substance is not reflected in a temperature change, the energy is used to increase the kinetic energy of the molecules and thus to change state. Latent heat is the energy price that must be paid for a change of state from a solid to a liquid or from liquid to a gas.

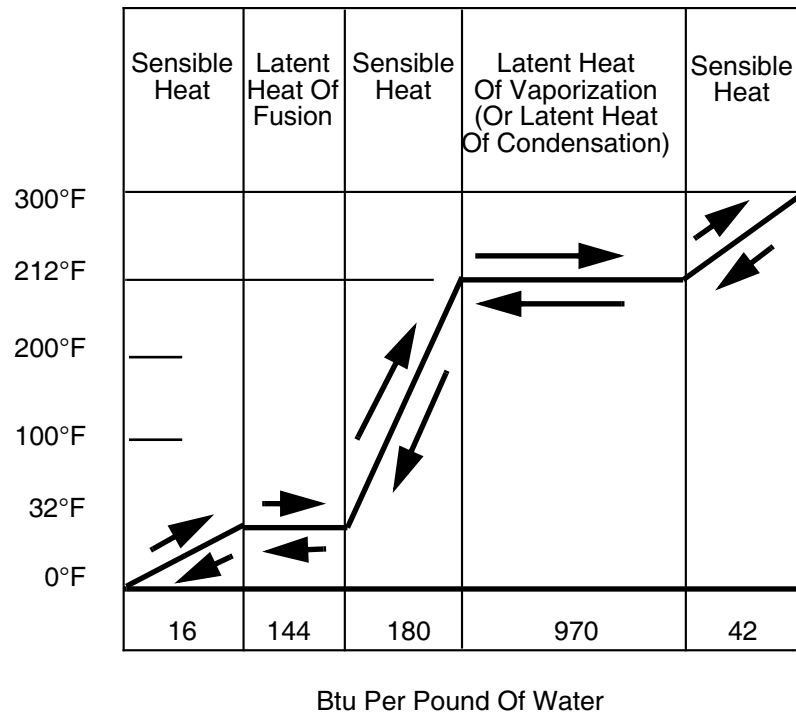

**Figure 1-37: Temperature - Heat Diagram for 1 lb of water at atmospheric pressure.**

The energy price is repaid when the substance changes back from gas to liquid or from liquid to solid. Heat flows from the substance during these changes of state.

Figure 6-6 shows the relationship between sensible heat and latent heat for water at atmospheric pressure. The same kind of chart could be drawn for other substances; however, different amounts of thermal energy would be involved in the changes of state.

Starting with one pound of ice at 0°F, 16 Btu's are required in order to raise the temperature of the ice to 32°F. To change the pound of ice at 32°F. to a pound of water at 32°F., 144 Btu's (the latent heat of fusion) must be added. There will be no change in temperature while the ice is melting.

After the ice has melted, the temperature of the water will be raised as additional heat is applied. If 180 Btu's - that's one Btu for each degree of temperature between 32°F. and 212°F. - the temperature of the water will be raised to the boiling point. To change the pound of water at 212 °F. to one pound of steam at 212°F., 970 Btu's (the latent heat of vaporization) must be added.

After the water has been converted to steam, the addition of more sensible heat will cause an increase in the temperature of the steam. Adding an additional 42 Btu's to the pound of steam at 212°F. will cause the steam to superheat to 300°F.

The same relationship applies when heat is being removed. The removal of 42 Btu's to the pound of steam at 300°F. will cause the temperature to drop to 212°F. As the pound of steam at 212°F. changes to a pound of water at 212°F., 970 Btu's are given off. When a substance is changing from a gas or vapor to a liquid, latent heat of condensation is given off.

Notice that the latent heat off condensation is exactly the same as the latent heat of vaporization.

The removal of another 180 Btu's of sensible heat will lower the temperature of a pound of water from 212°F. to 32°F. As a pound of water at 32°F. changes to a pound of ice at 32°F., 144 Btu's are given off without any accompanying change in temperature. Further removal of heat causes the temperature of the ice to decrease.

Figure 6-6 shows that it only takes 16 Btu's to raise the temperature of one pound of ice from 0°F. to 32°F. - that's only 1/2 Btu for each degree of rise in temperature. This is similar to the Btu's needed to raise the temperature of the steam (superheated) 88°F. - 42 Btu. However, it takes one Btu (on the average) to raise the temperature of the same amount of water 1°F. This difference occurs because the specific heat of water is about twice the specific heat of ice and also steam.

### **Rated Boiler Output**

The basis of a firetube boiler rating is the boiler horsepower. This is defined as the evaporation of 34.5 pounds of water per hour into dry saturated steam. The steam is from a water temperature of 212°F, and the steam is at 212°F. (0 psig) (see Table 6-2).

The latent heat of a pound of steam is 970 Btu/Pound. Therefore, 34.5 Pounds/Hour/Horsepower times 970 Btu/Pound of steam equals 33,472 Btu/Hour per Boiler Horsepower.

### **Factor of Evaporation**

Assume that we have a 100 horsepower boiler which has an output of 3,450 pounds of Steam/Hour from and at 212°F. This is equal to an output of 3,347,200 Btu/Hour. The boiler is burning 4,184,000 Btu/Hour of natural gas and is transmitting 80% of the heat to the water.

If the feedwater is not 212°F., some of the Btu/Hour will be required to add sensible heat or heat the liquid to get the water up to 212°F.

When making steam at pressures above (0) psig, the boiling temperature rises. This means additional Btu/Hour of sensible heat must be added to get from 212°F. up to the higher boiling temperature. The result is part of the required

energy is used to add sensible heat and part of it is used to vaporize the water.

For example, a 100 horsepower boiler has an output of 3,450 pounds of Steam/Hour from and at 212°F., or 3,347,200 Btu/Hour. Assume a feedwater temperature of 100°F. (which is not recommended) and an operating pressure of 10 psig.

At 10 psig, the boiling temperature equals 240°F., 240 minus 100 equals 140 Btu/Pound which must be added to the 100°F. feedwater to bring it up to 240°F.

Now, at 10 psig, the latent heat equals 953 Btu/Pound; therefore 953 Btu must be added to each pound of water at 240°F. in order to vaporize it.

Feedwater at a temperature of 100°F., must receive a total of 1093 Btu's per pound of water (140+953) in order to convert to steam at a pressure of 10 psig.

Therefore, the rated output of 3,347,200 Btu/Hour divided by 1093 Btu per pound equals an output of 3062 pounds of Steam/Hour with the given conditions. Note: 3062 Pounds/Hour compared to the rated output of 3450 Pounds/Hour from and at 212°F. Dividing the rated 3450 by the 3062, equates to 1.12, which is called the factor of evaporation.

If the requirement was 3450 pounds of Steam/Hour, to meet the load demand, a minimum of a 112 Horsepower Boiler would be required to meet the demand under the given conditions (100°F., 10 psig operating pressure).

**Table 6-2: Pounds of Dry Saturated Steam per Boiler Horsepower**

Feed-Water Temp.	Gauge Pressure – psig																		
	0	2	10	15	20	40	50	60	80	100	120	140	150	160	180	200	220	240	
30	29.0	29.0	28.8	28.7	28.6	28.4	28.3	28.2	28.2	28.1	28.0	28.0	27.9	27.9	27.9	27.9	27.9	27.9	27.8
40	29.3	29.2	29.1	29.0	28.9	28.7	28.6	28.5	28.4	28.3	28.2	28.2	28.2	28.2	28.2	28.1	28.1	28.1	28.1
50	29.6	29.5	29.3	29.2	29.1	28.9	28.8	28.8	28.7	28.6	28.5	28.5	28.4	28.4	28.4	28.3	28.3	28.3	28.3
60	29.8	29.8	29.6	29.5	29.4	29.2	29.1	29.0	28.9	28.8	28.8	28.7	28.7	28.6	28.6	28.6	28.6	28.6	28.5
70	30.1	30.0	29.9	29.8	29.7	29.5	29.4	29.3	29.2	29.1	29.0	29.0	28.9	28.9	28.9	28.8	28.8	28.8	28.8
80	30.4	30.3	30.1	30.0	30.0	29.8	29.6	29.6	29.5	29.3	29.2	29.2	29.2	29.1	29.1	29.1	29.1	29.1	29.0
90	30.6	30.6	30.4	30.3	30.2	30.0	29.9	29.8	29.7	29.6	29.5	29.5	29.4	29.4	29.4	29.3	29.3	29.3	29.3
100	30.9	30.8	30.6	30.6	30.5	30.3	30.2	30.1	30.0	29.8	29.8	29.8	29.7	29.7	29.7	29.6	29.6	29.6	29.6
110	31.2	31.2	30.9	30.8	30.8	30.6	30.4	30.3	30.2	30.0	30.0	30.0	30.0	30.0	29.9	29.9	29.8	29.8	29.8
120	31.5	31.4	31.2	31.2	31.1	30.8	30.7	30.6	30.5	30.4	30.3	30.3	30.2	30.2	30.2	30.1	30.1	30.1	30.1
130	31.8	31.7	31.5	31.4	31.4	31.1	31.0	30.9	30.8	30.7	30.6	30.6	30.5	30.5	30.4	30.4	30.4	30.4	30.4
140	32.1	32.0	31.8	31.7	31.6	31.4	31.3	31.2	31.1	31.0	30.9	30.8	30.8	30.8	30.8	30.7	30.7	30.7	30.6
150	32.4	32.4	32.1	32.0	31.9	31.7	31.6	31.5	31.4	31.2	31.2	31.2	31.1	31.1	31.0	31.0	30.9	30.9	30.9
160	32.7	32.7	32.4	32.4	32.3	32.0	31.9	31.8	31.7	31.5	31.4	31.4	31.4	31.4	31.3	31.3	31.2	31.2	31.2
170	33.0	33.0	32.7	32.6	32.6	32.3	32.2	32.1	32.0	31.8	31.7	31.7	31.7	31.6	31.6	31.6	31.5	31.5	31.5
180	33.4	33.3	33.0	33.0	32.9	32.6	32.5	32.4	32.3	32.2	32.1	32.0	32.0	32.0	31.9	31.9	31.8	31.8	31.8
190	33.8	33.7	33.4	33.3	33.2	32.9	32.8	32.7	32.6	32.5	32.4	32.4	32.3	32.3	32.2	32.2	32.1	32.1	32.1
200	34.1	34.0	33.7	33.6	33.5	33.2	33.1	33.0	32.9	32.8	32.7	32.6	32.6	32.6	32.6	32.5	32.4	32.4	32.4
212	34.5	34.4	34.2	34.1	33.8	33.6	33.5	33.4	33.3	33.2	33.1	33.0	33.0	33.0	32.9	32.9	32.8	32.8	32.8
220	34.8	34.7	34.4	34.3	34.2	33.9	33.8	33.7	33.5	33.4	33.3	33.3	33.2	33.2	33.1	33.1	33.1	33.1	33.0
227	35.0	34.9	34.7	34.5	34.4	34.1	34.0	33.9	33.8	33.7	33.6	33.5	33.5	33.4	33.4	33.3	33.3	33.3	33.3
230	35.2	35.0	34.8	34.7	34.5	34.2	34.1	34.0	33.9	33.8	33.7	33.6	33.6	33.5	33.5	33.4	33.4	33.4	33.4

**Notes**

## Abbreviations

Following is an explanation of the abbreviations, acronyms, and symbols used in this guide.

AC	Alternating Current
AR	Automatic Reset
ASME	American Society of Mechanical Engineers
ASTM	American Society of Testing and Materials
BHP	Boiler Horsepower
BTU	British Thermal Unit
°C	Degrees Celsius
CFH	Cubic Feet per Hour
Cu Ft	Cubic Feet
CFM	Cubic Feet Per Minute
DC	Direct Current
°F	Degrees Fahrenheit
FM	Factory Mutual
FS	Flame Safeguard
ft	Feet
GPM	Gallons per Minute
Hd	Head
Ht	Height
HTB	High Turndown Burner
Hz	Hertz
In H <sub>2</sub> O	Inches of Water
IRI	Industrial Risk Insurance
Lb	Pound
LE	Low Emission
LWCO	Low-Water Cut-Off
MM	Million
MFD	Micro-Farad
MR	Manual Reset
NEC	National Electric Code
No.	Number
pH	Measure of the degree of acid or base of a solution
P/N	Part Number
PPM	Parts Per Million
PR	Program Relay
psi	Pounds Per Square Inch
SAE	Society of Automotive Engineers
scfh	Standard Cubic Feet per Hour
T	Temperature
TC	Temperature Control
TI	Temperature Gauge
UL	Underwriter's Laboratories
V	Volt
WC	Water Column
WSI	Watts Per Square Inch

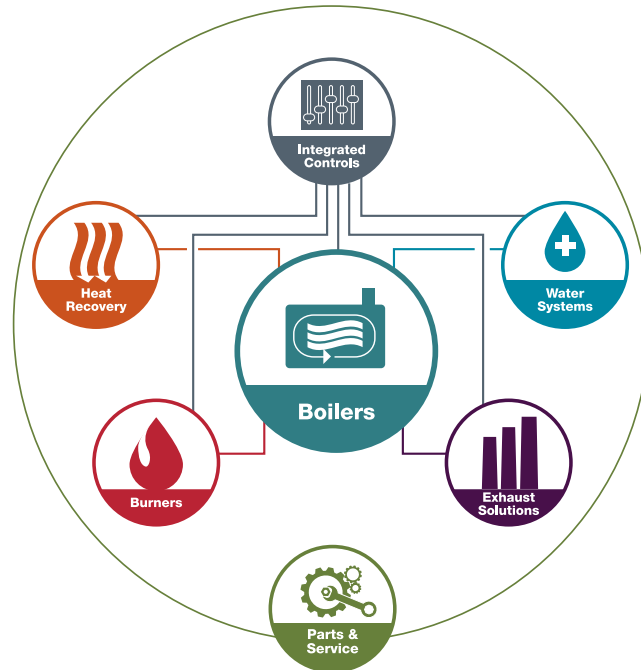

# The most comprehensive, integrated solutions.

Cleaver-Brooks sets the bar for industry-leading, energy-efficient, low-emissions products for your boiler room. Whether it's a new boiler installation, from the smallest electric commercial boiler to the largest industrial boiler, or retrofitting your current facility, Cleaver-Brooks fully integrated systems, including boilers, burners, controls, and auxiliary equipment, supply the most efficient solutions in the world. Only Cleaver-Brooks boiler systems have the power of total integration for your entire boiler room, built in from the ground up.



Packaged Boiler Systems  
 221 Law Street, Thomasville, GA 31792 USA  
 800.250.5883 • info@cleaverbrooks.com  
 cleaverbrooks.com